

Approximate dimensions ^① Stacklights

Stacklights

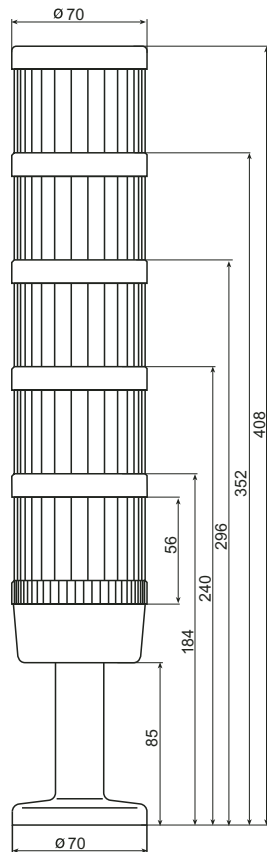

Contact box for cable exit at side

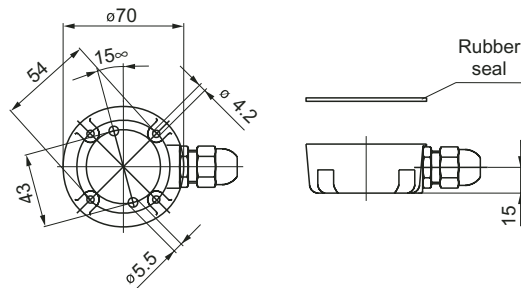

Base for tube, plastic

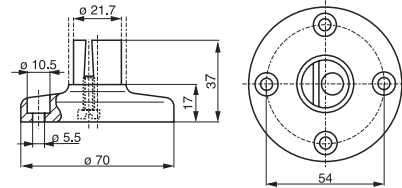

Contact box with magnetic base

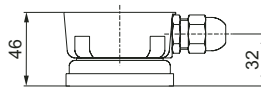

Base for tube, metal

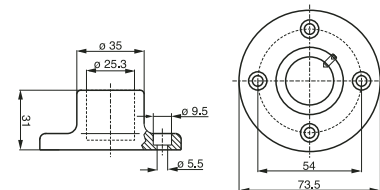

Base with integrated tube

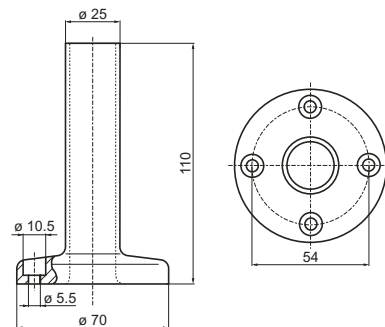

Connection plan

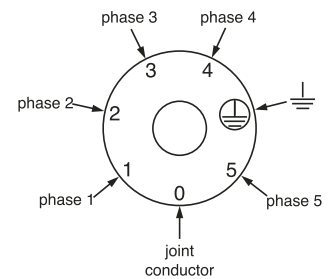

Module

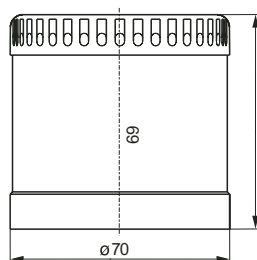

Bracket 1-sided mounting

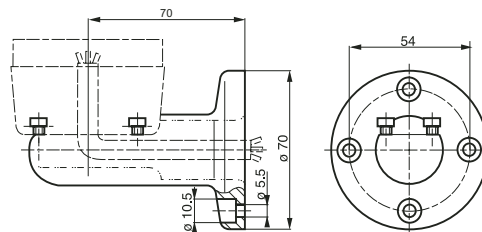

Connection plan with AS Interface module

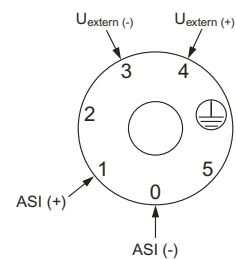

Drilling plan for stacklights

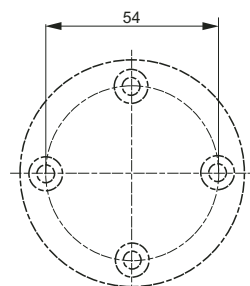

Bracket 2-sided mounting

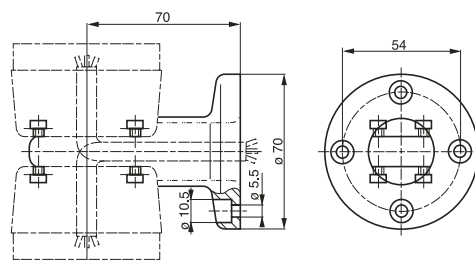

^① All dimensions in millimeters.