

# Approximate dimensions for 3 pole, AC & DC operated A contactors & starters A30 – A(E)75

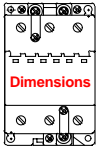

00.00 Inches  
00.00 Millimeters

## A30 & A40 + VM5 or VE5 + TA25 — Reversing starter, 3 pole, AC operated

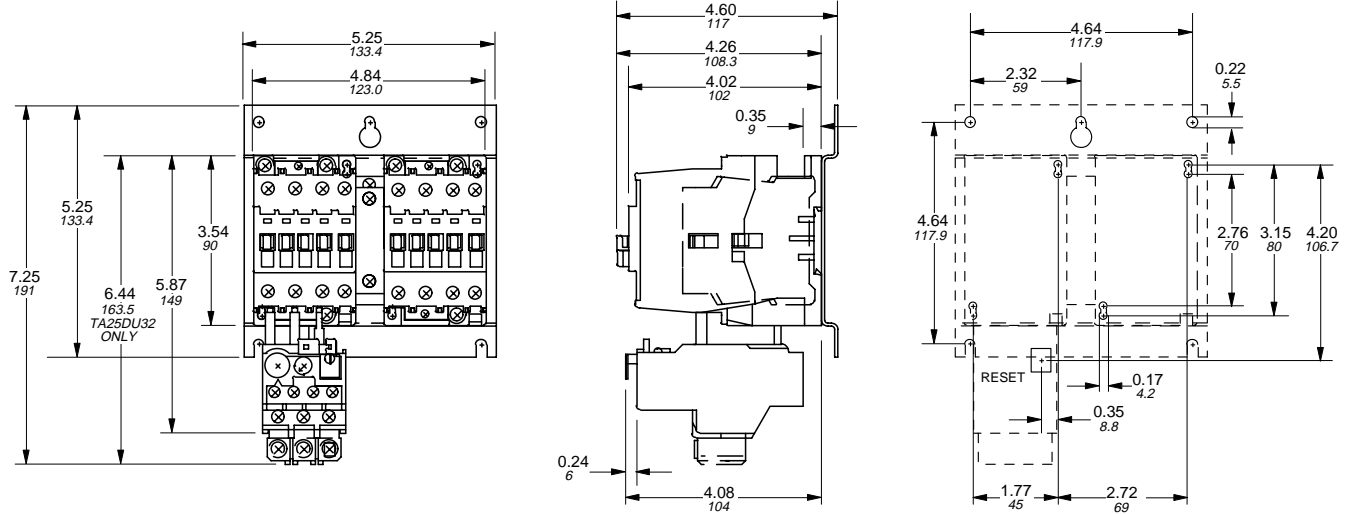

## A30 & A40 + VM5 or VE5 + TA42 — Reversing starter, 3 pole, AC operated

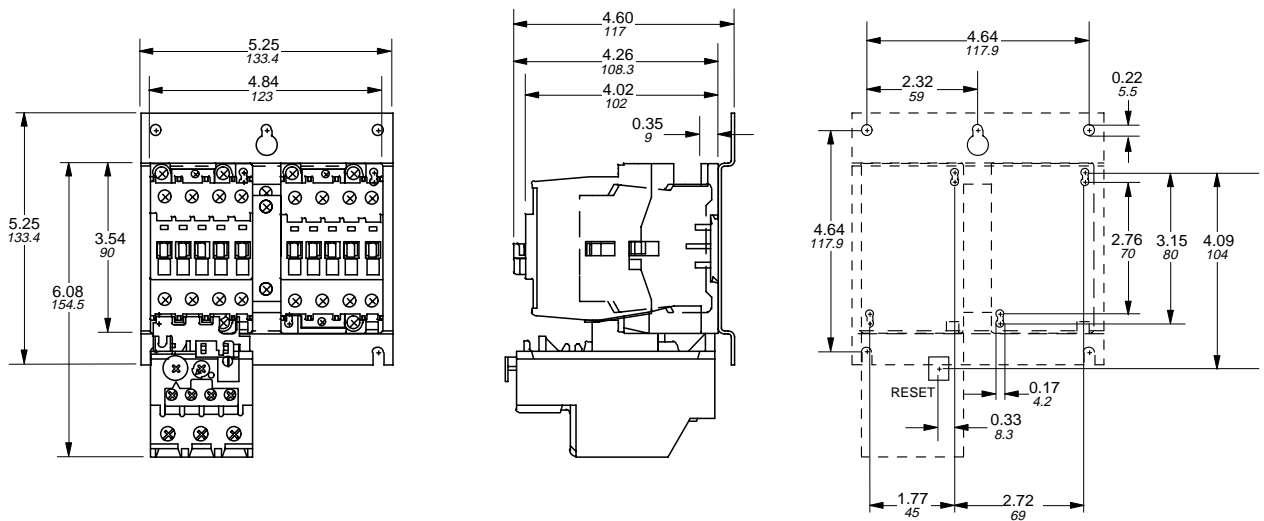

## A(E)50 – A(E)75 — Contactor, 3 pole, AC & DC operated

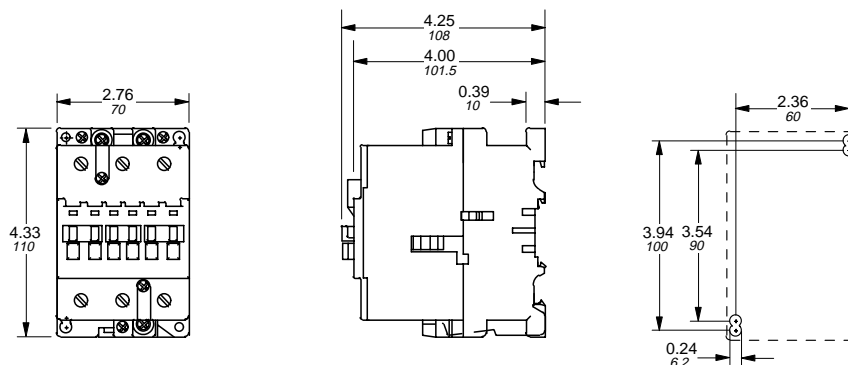

Contactors

AC 1030 – 6/98

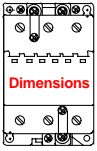

# Approximate dimensions for 3 pole, AC & DC operated A contactors & starters A(E)50 – A(E)75

← 00.00 → Inches  
00.00 → Millimeters

**A(E)50 – A(E)75 + VM5 or VE5 — Mechanically interlocked contactor, 3 pole, AC & DC operated**

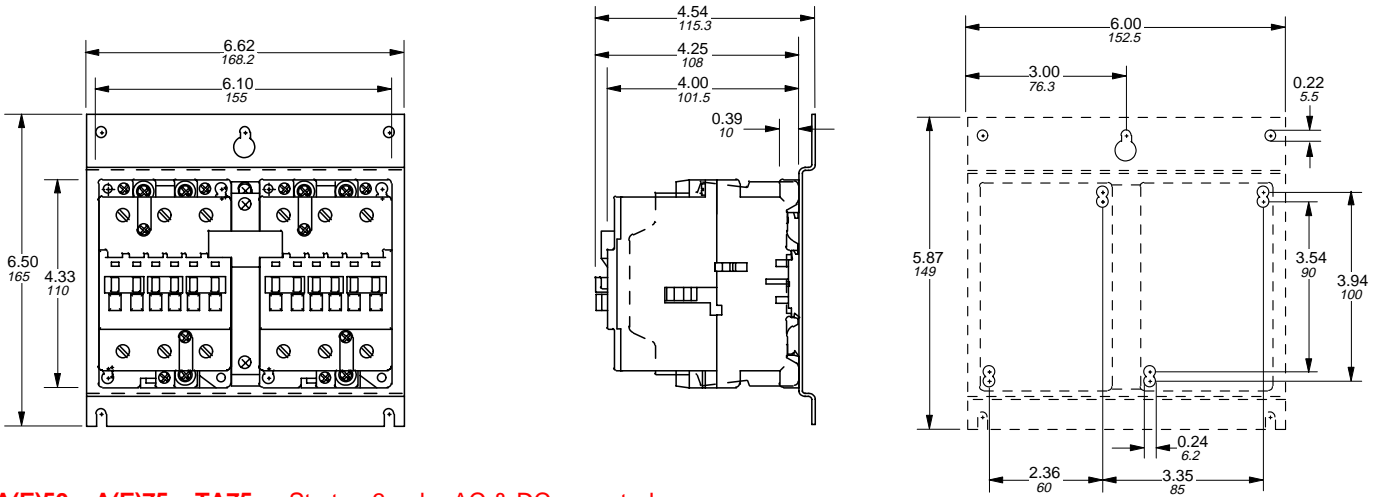

**A(E)50 – A(E)75 + TA75 — Starter, 3 pole, AC & DC operated**

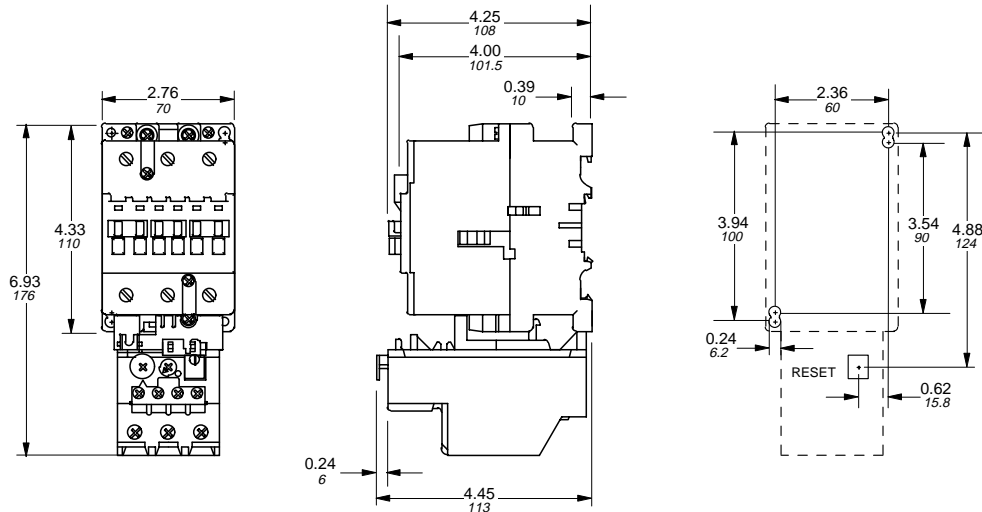

**A(E)50 – A(E)75 + VM5 or VE5 + TA75 — Reversing starter, 3 pole, AC & DC operated**

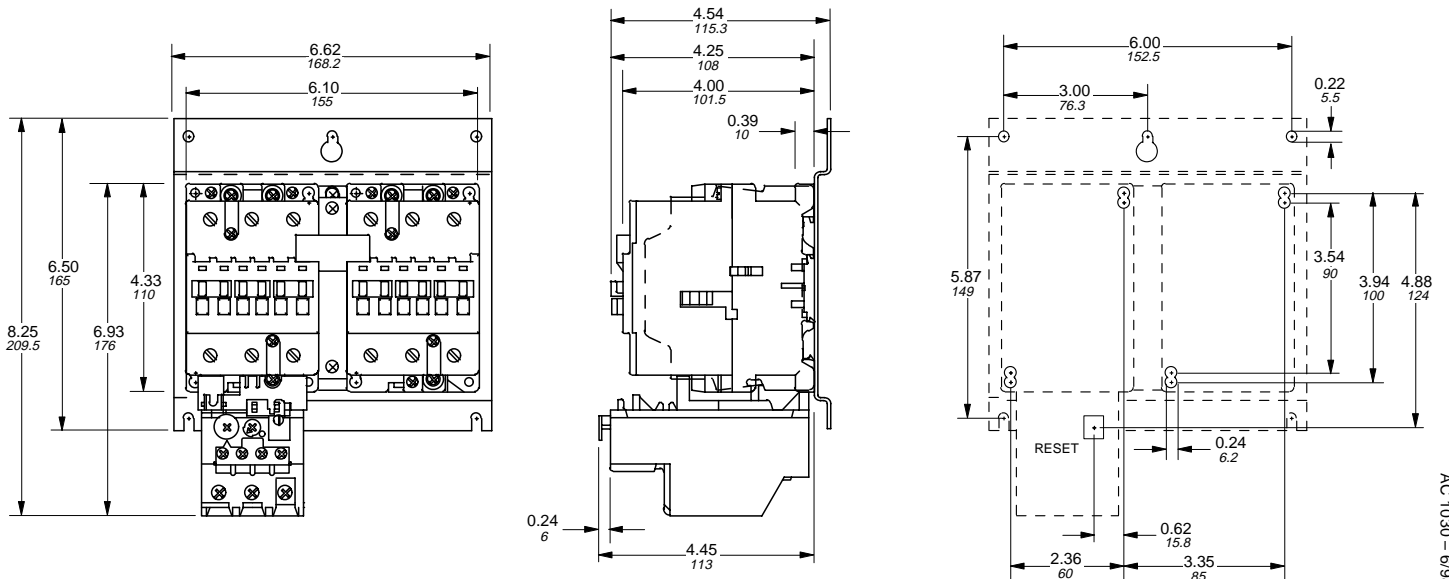

AC 1030 – 698

Contactors

# Approximate dimensions for 3 pole, AC & DC operated A contactors & starters A(E)95 & A(E)110

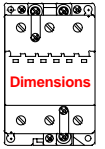

00.00 Inches  
00.00 Millimeters

**A(E)95 & A(E)110 — Contactor, 3 pole, AC & DC operated**

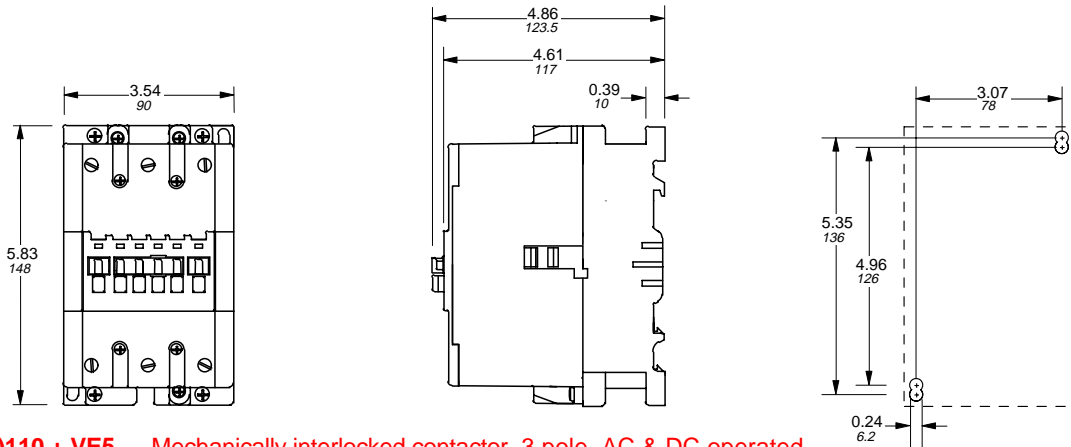

**A(E)95 & A(E)110 + VE5 — Mechanically interlocked contactor, 3 pole, AC & DC operated**

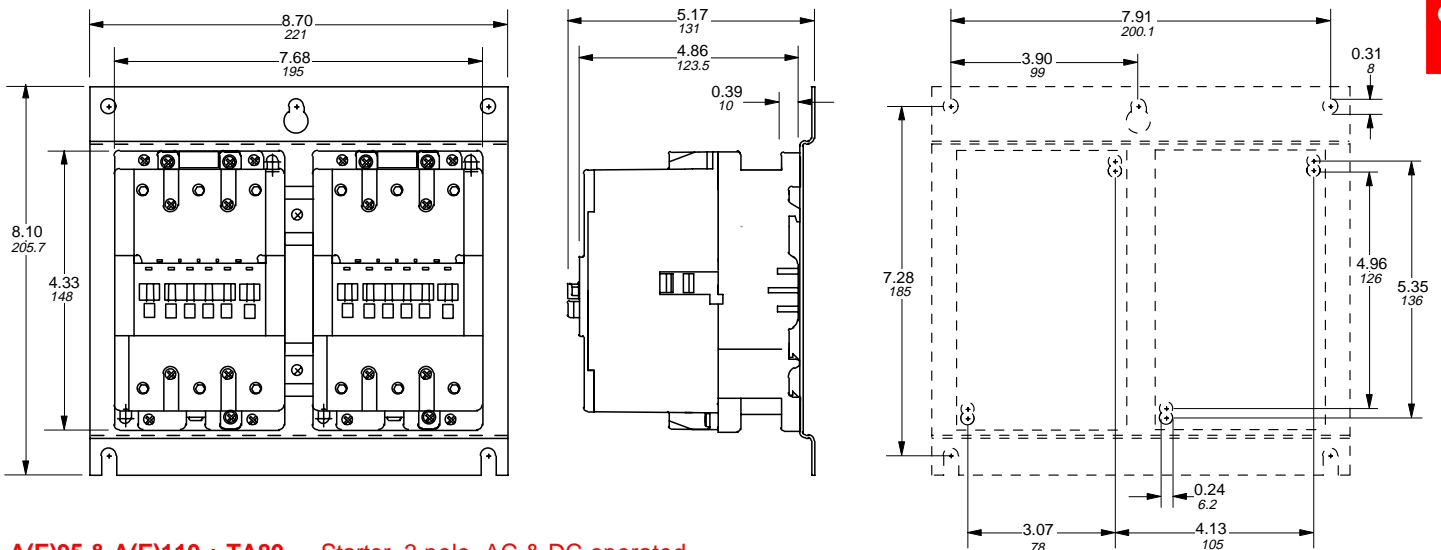

**A(E)95 & A(E)110 + TA80 — Starter, 3 pole, AC & DC operated**

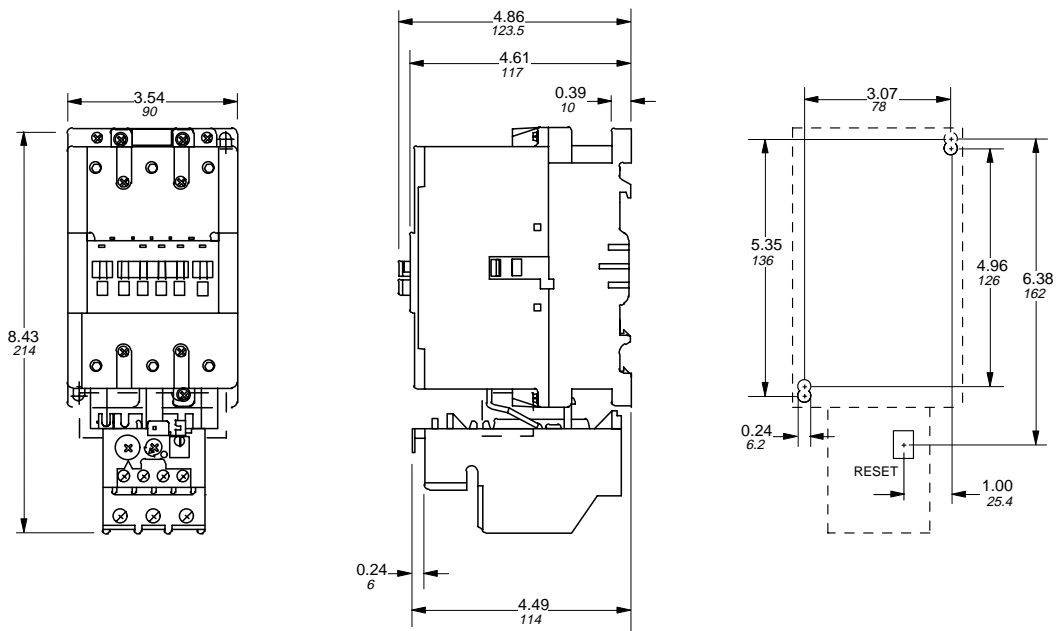

Contactors

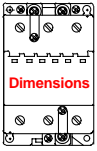

# Approximate dimensions for 3 pole, AC & DC operated A contactors & starters A(E)95 & A(E)110

← 00.00      Inches  
00.00      Millimeters →

A(E)95 & A(E)110 + TA110 — Starter, 3 pole, AC & DC operated

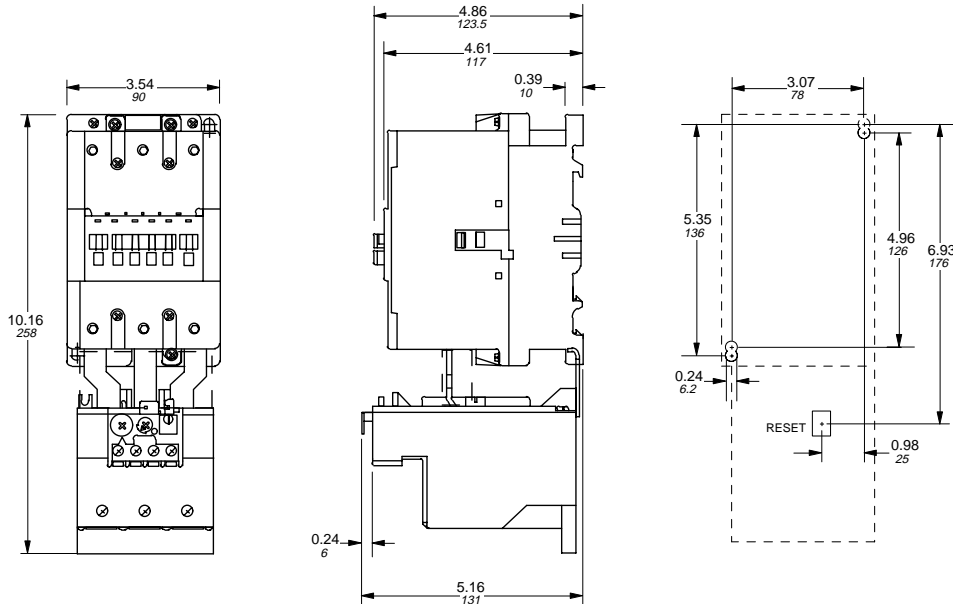

A(E)95 & A(E)110 + VE5 + TA80 — Reversing starter, 3 pole, AC & DC operated

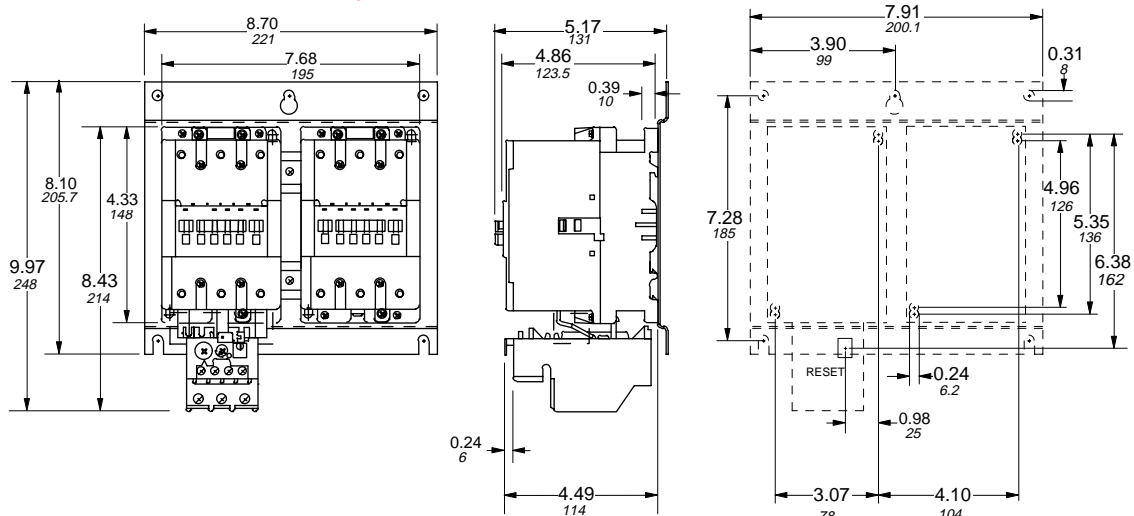

A(E)95 & A(E)110 + VE5 + TA110 — Reversing starter, 3 pole, AC & DC operated

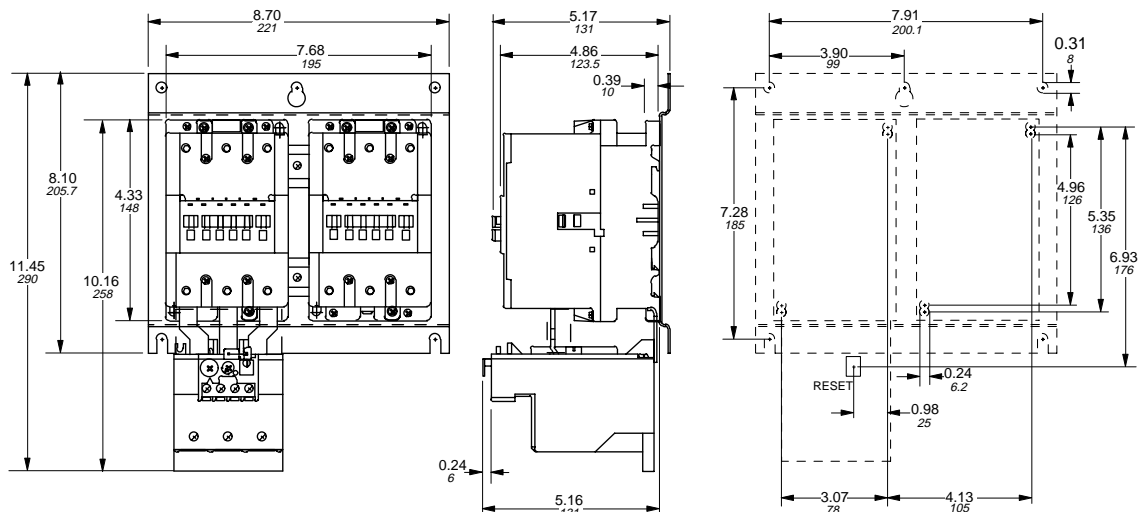

# Approximate dimensions for 4 pole, AC & DC operated A contactors & starters A9 – A(E)75

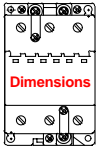

00.00 Inches  
00.00 Millimeters

## A9 – A16 — Contactor, 4 pole, AC operated

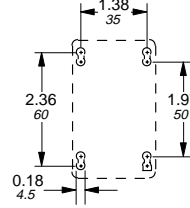
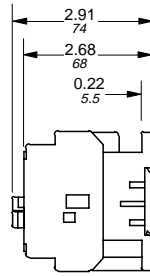
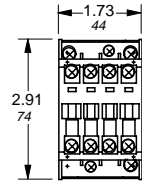

## A26 — Contactor, 4 pole, AC operated

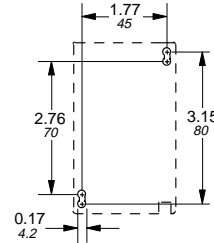
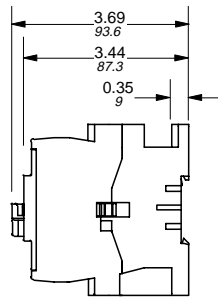
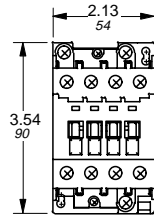

## A(E)45 — Contactor, 4 pole, AC & DC operated

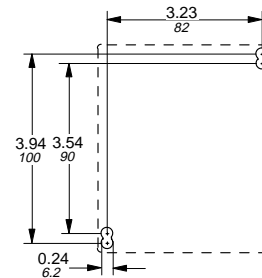
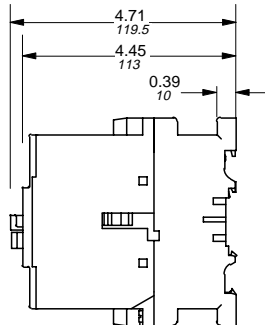
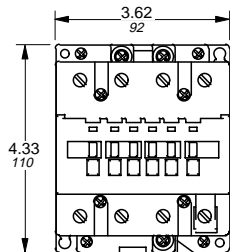

## A(E)50 – A(E)75 — Contactor, 4 pole, AC & DC operated

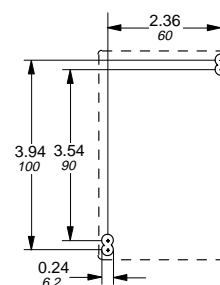
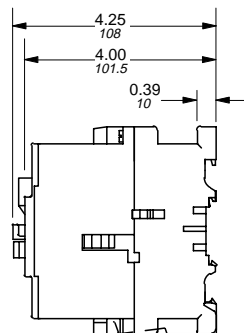
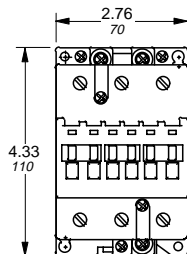

Contactors

AC 1030 – 6/98