

CATALOG

ABB drives for HVAC



ACH580 series

Leading the way in HVAC drives

Comfort. It's something we take for granted in the buildings we live and work in. But comfort requires efficient systems to control heating, ventilation, and air conditioning (HVAC) to ensure the air we breathe is pure and the temperature is comfortable. We also need to ensure air quality and safety in the most energy-efficient and cost-effective way in both normal and mission-critical situations.

For half a century, ABB has been leading the way in optimizing HVAC systems using drive control to ensure that you can take comfort for granted. The new ACH580 series of variable-frequency drives (VFDs) provides the quality, reliability, and energy savings you expect, and are easy to use and safe to maintain. All you need to do is to set the drive up, and then focus on what counts.

Contents

04–05	The next step in HVAC drives
06–07	Premier air handling
08–09	Precise water flow control
10–11	ACH580 drives offering
12–13	ACH580 ultra-low harmonic (ULH) drive
14–15	Common characteristics of the ACH580 drives family
16–17	Technical data
18	How to select a drive
19–26	Ratings, types and voltages
27	Option compatibility
28–34	Dimensions
35	Comprehensive connectivity
36	Options
37	High protection for operation in harsh environments
37	Flange mounting
38	ACS580 motor control
39	ABB Ability™ smartphone apps
40	Services to match your needs
41	Drives service – Your choice, your future
42	A lifetime of peak performance

The next step in HVAC drives

The new ACH580 drives come with a range of advanced features, such as a new primary settings menu that makes commissioning the drives much easier and faster. Optional Bluetooth connectivity offers improved accessibility for drives in remote areas and increases safety by letting users stay out of arc flash zones.

Simple to select, install and use

All the essentials – such as chokes, EMC filters, cabling clamps, certified BACnet communication, and enclosures from UL (NEMA) Type 1 to UL (NEMA) Type 12 – are a standard part of the drive, simplifying selection, installation, and commissioning.

Safe maintenance

The packaged disconnect solution provides a main disconnect switch, further increasing safety for people working on air-handling units.

Motor control options to meet your application needs

ACH580 drives can be integrated with several types of AC motors, even high-efficiency permanent magnet (PM) and synchronous reluctance (SynRM) motors. Using these motors can reduce your energy costs even more.



Additional I/O options

Take advantage of the added flexibility and accessibility – never be without back-up I/O points at the job site again.



ACH580 drives are ideal for HVAC fans, pumps, compressors, air-handling units, and chillers. These are used in hospitals, data centers, shopping centers, tunnel ventilation, factories, office buildings, and more.



Intuitive control panel

The drive's HVAC-specific software, intuitive control panel with customizable text, and menu-driven programming simplify setup and operation of even the most complex applications. You can customize the view so that it only shows the information you need, and it automatically saves a backup of your most recent configuration so that it's always available.



Optional Bluetooth® capability

ABB's new HVAC Bluetooth control panel lets you commission the drive remotely, safely outside the arc flash boundary. The Driwetune smartphone app allows you to commission and tune the drive from a distance, giving you access to the same primary settings and other menus available on the drive's HVAC control panel.



Reliable communication

BACnet MS/TP, Modbus RTU and Johnson Controls N2 are embedded in every ACH580. In addition, a wide range of optional fieldbus adapters are available to enable connectivity with all major building automation and control systems.

Harmonic mitigation

The drive provides reduced harmonics with built-in, optimized DC choke in a small and lightweight design.

Ultra-low harmonic (ULH) drive for a clean network

The revolutionary ACH580 ultra-low harmonic drive is designed specifically for the HVAC market, minimizing the effect of harmonics on your system. This all-in-one solution is fully integrated within the ACH580 platform and leverages the same programming tools, user settings, options, and functions, while providing superior harmonic performance.

Premier air handling

We understand the complexity of air handling systems and the need to produce high levels of comfort, control, and safety. Regardless of the season or external conditions, we help make your system efficient, safe, and informative.

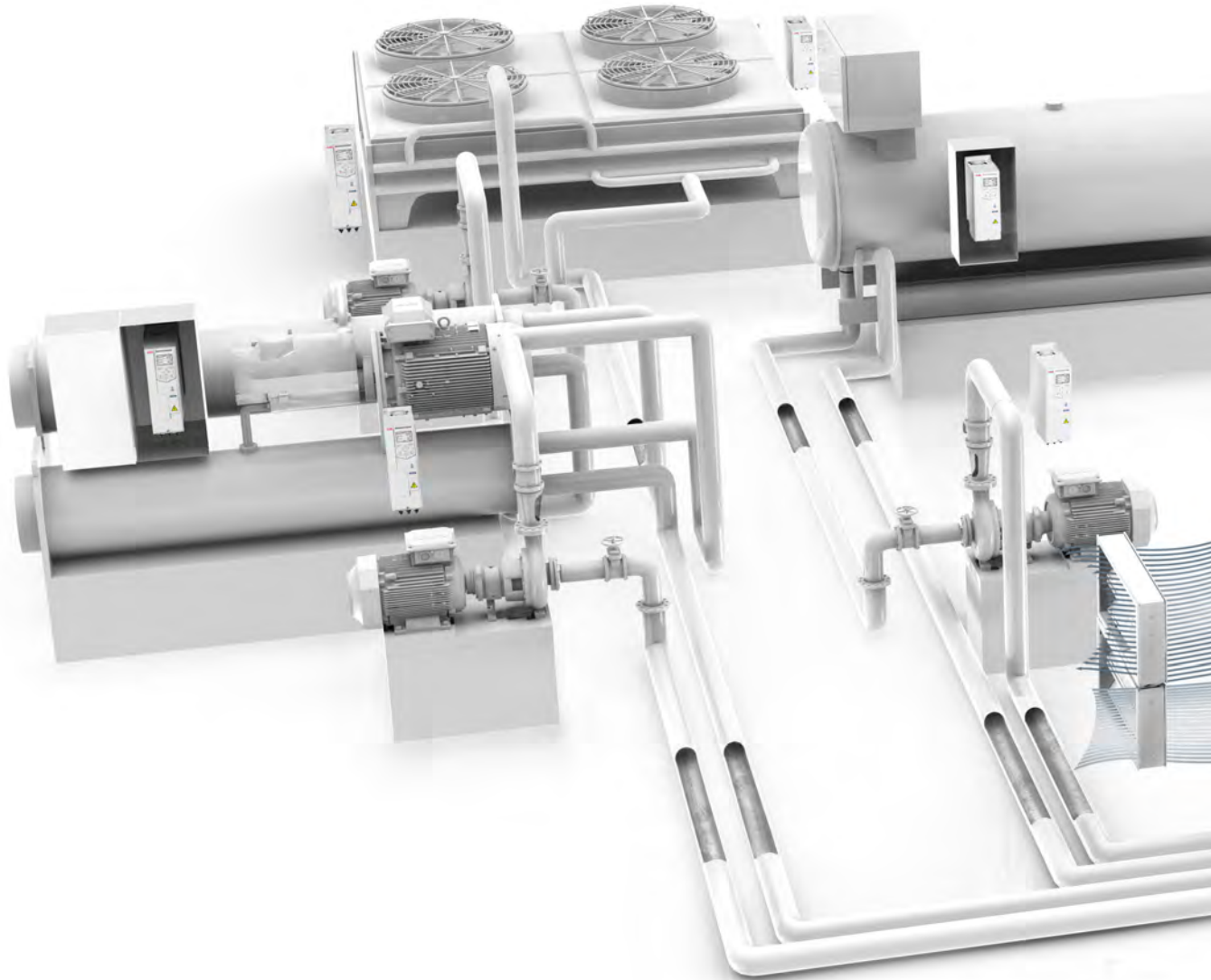

Effortless system startup

The ACH580 ensures a smooth, coordinated start to your HVAC system. Embedded interlock logic enables the drive to confirm that equipment such as dampers are in the right position and sensors are showing the correct status before operations begin. The control panel's Primary Settings menu and built-in assistants streamline commissioning, allowing basic setup to be completed in minutes. The Drive Composer PC tool simplifies the customization of the drive.

Increased energy savings

Increase energy savings by using the appropriate motor and drive combination. The ACH580 drive works with a variety of motors, such as induction, PM, or SynRM, enabling high efficiencies.

Improved safety

Built-in safety functionality, such as override mode, enables your system to override all non-essential faults during emergencies to maintain air quality in the fire exit paths.

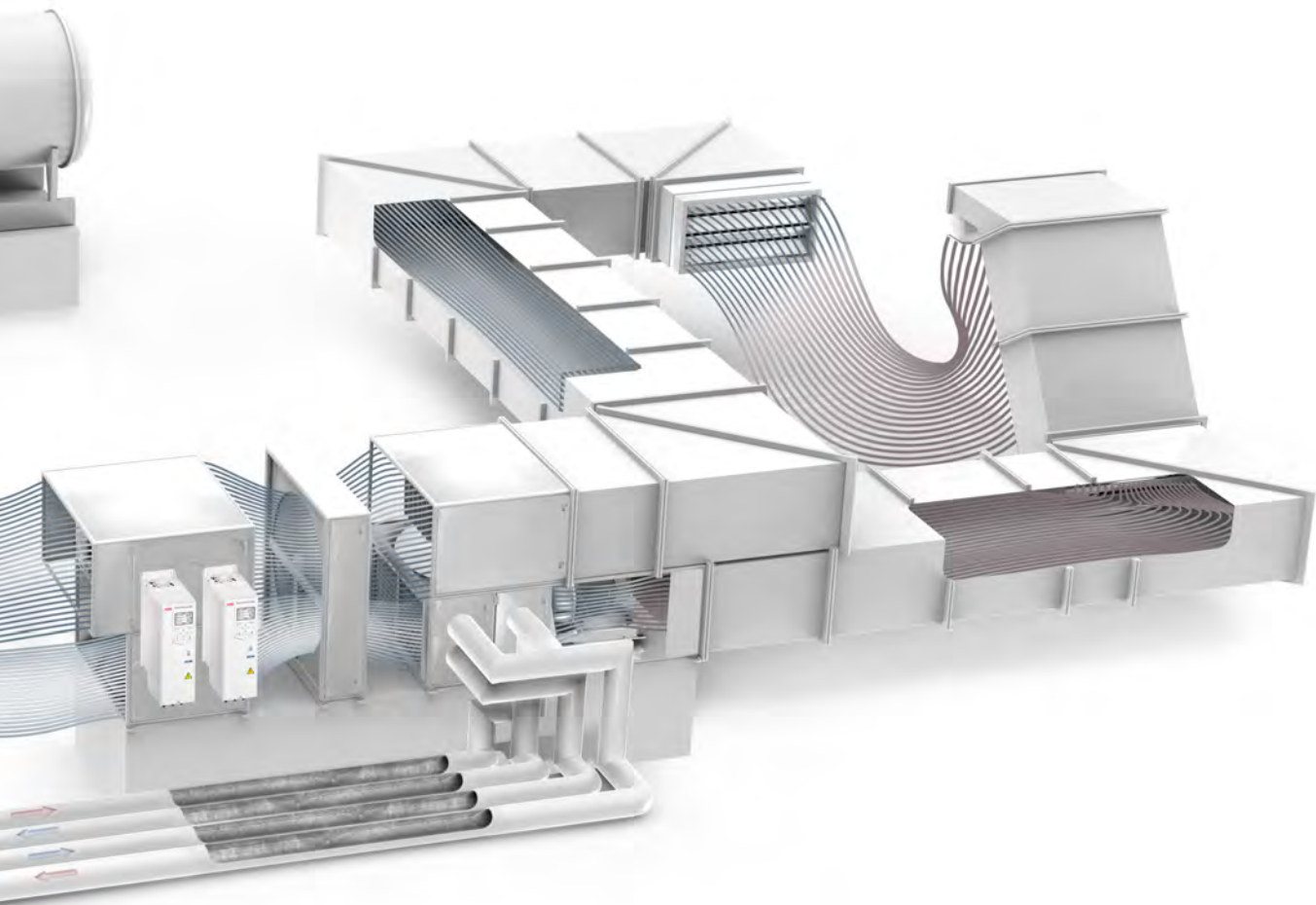

The control panel's optional Bluetooth capability provides an extra level of safety for commissioning and troubleshooting.

Reduced costs

The ACH580 reduces costs by eliminating dependencies on external controllers. The drive can use its internal PID loops to maintain a pressure setpoint by checking the active pressure and adjusting the fan speed accordingly.

Improved monitoring and maintenance

Leverage advanced system monitoring, giving you access to data on all aspects of the operation. Use this information to plan maintenance based on the actual needs of the application. With built-in monitoring, the drive lets you know when it's time to take action if a fan stalls, a belt breaks, a filter clogs, and more.

Precise water flow control

Controlling the flow of chilled water in HVAC systems allows you to regulate temperatures in a building. Your system benefits from motor control that coordinates pumps, chillers, and cooling towers to operate as efficiently and simply as possible, with functions designed to keep the flow rate in line with the needs of the chiller and the building.

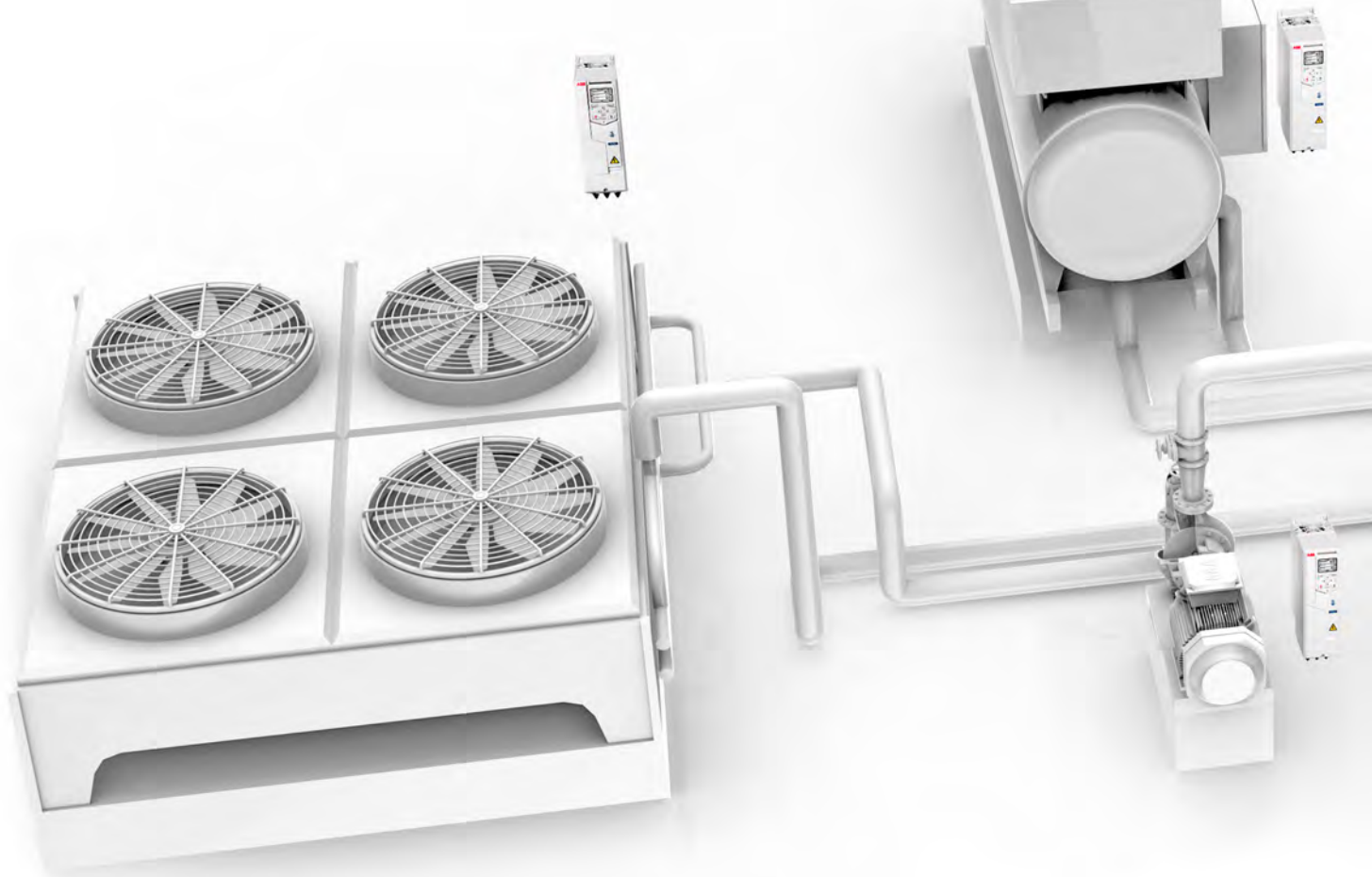

Motor monitoring prevents problems

Protect your investment with onboard monitoring. Monitor and show trends of key attributes for preventative maintenance.

Protect your equipment

Extend the life of your pipes, motors, valves, and pumps with intelligent motor control. By starting the pumping system smoothly and precisely managing flow and pressure, you protect the system from pressure surges.

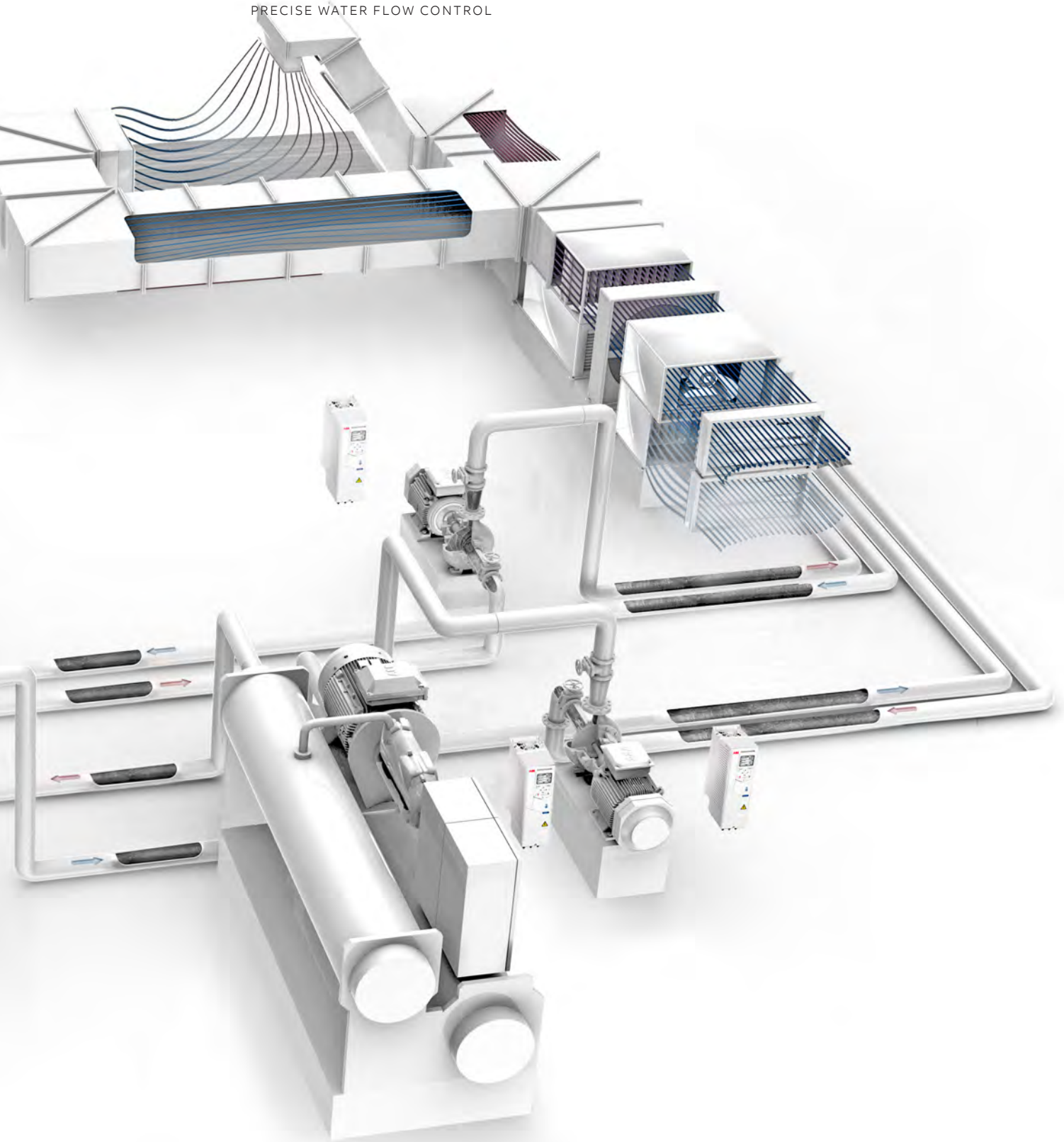
**Energy savings through intelligent control**

Intelligent motor control replaces throttle and bypass valves, enabling better control of flow, and resulting in energy savings. In addition, fewer mechanical parts means minimal wear and tear on the system.

System optimization

As demand fluctuates during the day, the system automatically adjusts. The ACH580 provides optimal pressure when needed, and goes into sleep mode when it's not.

ACH580 drives offering

All ACH580 drives offer ease of use, scalability, and reliability and comes in a variety of packages. They can be equipped with an intuitive Bluetooth control panel, allowing the drive to be configured directly via the control panel or via the Drivetune app. A robust HVAC firmware package provides drive, motor, and application protection features. The drive includes BACnet MS/TP, Modbus RTU, and Johnson Controls N2. Additional protocols, such as BACnet/IP and LonWorks, are available with optional fieldbus adapters.



Wall-mounted drives, ACH580-01

ACH580-01 wall-mounted drives are available in UL (NEMA) Type 1 to UL (NEMA) Type 12 protection class with a power range up to 350 hp and offer side-by-side, flange, and horizontal mounting options. The UL (NEMA) Type 12 variants are designed for applications exposed to dust, moisture, vibration, and other harsh conditions. The ACH580-01 is a six-pulse drive that includes an optimized DC link choke for harmonic mitigation.



Ultra-low harmonic drives, ACH580-31

ACH580-31 ultra-low harmonic drives help to keep the power network clean. The ACH580 ultra-low harmonic (ULH) drive provides an unprecedented compact design that delivers unity power factor with a 3% or less THDi. By meeting the most stringent requirements of the IEEE519 recommendations, the ACH580 ULH drive reduces any risk of electrical disturbance when operating on a back-up generator.



E-Clipse bypass drive, ACH580-VCR, ACH580-VDR, ACH580-BCR, ACH580-BDR

The ACH580 with ABB E-Clipse bypass has an integrated UL (NEMA) Type 1, 12 or 3R enclosure with a bypass motor starter and is available from 1 to 350 hp at 230/460/575 V. The ACH580 with ABB E-Clipse bypass provides an input disconnect switch or circuit breaker with door mounted and interlocked switch (padlockable in the OFF position), a bypass starter, electronic motor overload protection, a door mounted control panel with graphical display for local control, provisions for external control connections, and serial communications capability.



Packaged drive with disconnect means, ACH580-PCR, ACH580-PDR

The ACH580 Packaged Drive includes an ACH580 drive in a UL (NEMA) Type 1, 12 or 3R enclosure with either an input disconnect switch and fast acting fuses or an input circuit breaker. It is available from 1 to 350 hp at 230/460/575 V. The ACH580 Packaged Drive provides a door-mounted input disconnect switch (padlockable in the OFF position), electronic motor overload protection, a door mounted control panel with graphical display for local control, provisions for external control connections, and serial communications capability.

The entire ACH580 product family provides a consistent user interface and features, making it easy for you to install, commission and use throughout your facility.

ACH580 ultra-low harmonic (ULH) drive

What are harmonics?

In an ideal case the current in an AC grid is a pure sine wave and does not contain harmonics. In reality the current deviates from this pure sine wave and contains harmonics. Harmonics are typically measured as a percentage value, called total harmonic distortion (THD).

Harmonics can cause damage to sensitive electronic equipment, interference to communication equipment, tripping of circuit breakers, blowing of fuses and capacitor failures. The effects can also include overheating of cables, light ballast, motors, overloading of transformers, generator failure and power factor capacitor damage.

—
01
Diode supply

—
02
Active supply

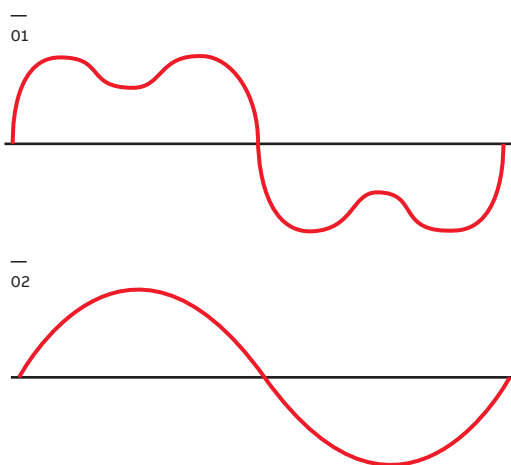

Complete HVAC functionality

The ACH580 ULH comes standard with an intuitive control panel used to configure, control, and monitor the drive. An optional Bluetooth control panel allows the drive to be configured via the control panel or the DriveTune app.

A robust HVAC firmware package provides drive, motor, and application protection features. Application specific features, such as accepting four separate start interlocks (safeties), along with broken belt detection, are also included. The drive includes BACnet MS/TP, Modbus RTU, and Johnson Controls N2 as standard.

Savings in total cost of ownership

Installation costs are reduced with the simple 3 wires in and 3 wires out design. Maintenance costs are lowered as compared to other harmonic mitigation solutions like passive filters, multi-pulse and active filters there are less components to maintain and stock as spares.

Using the ACH580 ULH allows your engineer to design your electrical system and backup generators to the right size and not oversizing for the harmonics in the network.

Reliability for your building

Harmonics in the network could cause problems with other electrical equipment in the same electrical network. In the worst case it might cause your sensitive electrical equipment to fail.

Harmonics can cause problems also in retrofit projects. In such projects, a transformer might not be able to meet the harmonic levels caused by non-linear loads such as standard 6-pulse drives, so there is a risk of overloading the transformer.

In addition to problems caused by harmonics, also weak network can cause troubles to your systems. Weak electrical networks that have sags in line voltage may cause motors to overheat, trip or fail.

The ACH580 ULH drive offers a reliable solution to overcome these challenges as it is able to lower the harmonic content so that sensitive equipment stay running and transformers or generators don't fail. Also the ACH580 ULH can boost output voltage so that motor always runs with nominal voltage despite the fluctuations in line voltage.

Optimized size and performance

ACH580 ULH has all the harmonic mitigation technology in the drive. With a THDi of 3% or less, there is no need for external components to install with the drive for reducing harmonics, this drive doesn't create the harmonics to fix.

ACH580 ultra-low harmonic packaged drives with disconnect

The ACH580 ultra-low harmonic (ULH) packaged drive is an ACH580 ULH variable frequency drive enclosed with either an input disconnect switch and fast acting fuses (ACH580-3PDR) or an input circuit breaker (ACH580-3PCR). The ACH580 packaged drive provides a door-mounted input disconnect operator (padlockable in the OFF position), electronic motor overload protection, a door mounted control panel with graphical display for local control, provisions for external control connections, and serial communications capability.

ACH580 ultra-low harmonic drive E-Clipse bypass

The ACH580 ultra-low harmonic (ULH) drive with ABB E-Clipse bypass is an ACH580 HVAC drive in an integrated UL (NEMA) Type 1, 12 or 3R enclosure with a bypass motor starter. The ACH580 ULH drive with ABB E-Clipse bypass provides an input disconnect switch or circuit breaker with door mounted and interlocked operator (padlockable in the OFF position), a bypass starter, electronic motor overload protection, a door mounted control panel with graphical display for local control, provisions for external control connections, and serial communications capability. Configurations with the +F267 option include a drive service switch.

Technical details and documentation

PDF, BIM, CAD Drawings and 3D models are available for planning your building.



Common characteristics of the ACH580 drives family



ACH580 series

HVAC control panel with primary settings

- Primary settings makes commissioning the drive easier than ever before
- The optional Bluetooth-enabled control panel allows easy smartphone connection and remote support capability
- Easily available USB interface for PC and tool connection
- Help button for problem-solving

HVAC communication protocols

- The most common HVAC communication protocols – BACnet MS/TP, Johnson Controls N2 and Modbus RTU – are standard
- BACnet/IP with optional fieldbus adapter

Ingress protection

- ACH580 drives are available in multiple different UL/NEMA classes. Check the details at the end of this catalog.

Suitable for various HVAC applications

- Suitable not only for variable-torque applications like fans and pumps, but also for basic constant-torque applications like compressors
- Support for induction, permanent magnet and synchronous reluctance motors

Reliability and quality

- All units are tested under full load at maximum allowed ambient temperature to verify quality
- Printed circuit boards have an extra coating to protect against humid and harsh environments

Harmonic mitigation options

- The ACH580-01 has optimized DC chokes standard for harmonic mitigation.
- Compliant with IEC/EN61000-3-12
- The ACH580-31 ultra-low harmonic drive results in harmonic current as low as 3 percent at the input terminals of the drive, meeting even the most stringent IEEE519 requirements.



Shared features of the ABB all-compatible drives portfolio

Drivetune smartphone app

- The Drivetune smartphone app together with the Bluetooth-enabled control panel allow you to set up and commission the drive remotely from a safe and comfortable location, using the same primary settings menu that is available on the control panel on the drive.

Energy efficiency calculators

- Optimize energy efficiency with features that help you to save and manage energy. You can monitor the hourly, daily cumulative, last hour, last day and last month energy consumption via kWh counters.

Diagnostic menu

- Analyze and resolve issues with the control panel's diagnostics menu. You can quickly analyze why the drive is performing as it is; running, stopped or running at the present speed.

Embedded load analyzers

- Analyze and optimize the application with the load profile log, which shows how the drive has been operating.

EMC/RFI category C2

- The EMC category C2 level design allows installation in commercial and residential buildings.

Reduced motor noise

- User-selectable switching frequencies to manage audible noise.

Integrated process control

- Reduce costs with built-in PID controllers, allowing drives to self-govern, limiting the need for external controllers.

Flexibility in programming

- Align the drive to the needs of your application and users with customized home screens and adaptive programming.

Extensive I/O capabilities

- ABB HVAC drives have an extensive number of I/O terminals in standard configuration
- Color-coded terminals and clear terminal marking significantly ease drive wiring process
- I/O status can be monitored via the I/O menu
- I/O can be forced on or off to verify the drive's programming

Same PC tools for ABB all-compatible drives

- Drive composer entry available for free at www.abb.com
- Same parameter structure makes the all-compatible platform easy to use

Connectivity

- ABB's F-series fieldbus adapters can be used throughout the all-compatible platform
- Fieldbus settings are made easy with the Primary Settings menu
- Bluetooth connectivity to apple and android devices

Technical data for the ACH580-01 and ACH580-31

Product compliance (complete list on following page)	
ACH580-01, ACH580-31	CE, UL, cUL, and EAC
Supply connection	
Input voltage (U_i)	
ACH580-xx-xxxA-2	208/240V
ACH580-xx-xxxA-4	480V
ACH580-xx-xxxA-6	600V
Input voltage tolerance	+10% / -15%
Phase	3-phase (1-phase, 240 V)
Frequency	48 to 63 Hz
Line Limitations	Max ±3% of nominal phase to phase input voltage
Power Factor (cos φ) at nominal load	
ACH580-01	0.98
ACH580-31	1.0
Efficiency at rated power	
ACH580-01	98.0%
ACH580-31	96.5%
Power Loss	Approximately 2% of rated power
Motor connection	
Supported motor control	Scalar and vector
Supported motor types	Asynchronous motor, permanent magnet motor (vector), SynRM (vector)
Voltage	3-phase, from 0 to supply voltage
Frequency	0 to 500 Hz
Short Term Overload Capacity Variable Torque	110% for 1 min/10min
Peak Overload Capacity Variable Torque	1.35 for 2 second (2 sec / 10 min)
Switching Frequency	2, 4, 8 or 12 kHz Automatic fold back in case of overload
Acceleration/Deceleration Time	0 to 1800 s
Short Circuit Current Rating (SCCR)	100 kA with fusing

Inputs and outputs (drive)	
2 analog inputs	Selection of Current/Voltage input mode is user programmable.
Voltage reference	0 (2) to 10 V, R _{in} > 200 kΩ
Current reference	0 (4) to 20 mA, R _{in} = 100 Ω
Potentiometer reference value	10 V ±1% max. 20 mA
2 analog outputs	AO1 is user programmable for current or voltage. AO2 current
Voltage reference	0 to 10 V, R _{load} : > 100 kΩ
Current reference	0 to 20 mA, R _{load} : < 500 Ω
Applicable potentiometer	1 kΩ to 10 kΩ
Internal auxiliary voltage	24 V DC ±10%, max. 250 mA
Accuracy	+/- 1% full scale range at 25°C (77°F)
Output updating time	2 ms
6 digital inputs	12 to 24 V DC, 10 to 24 V AC, Connectivity of PTC sensors supported by a single digital input. PNP or NPN connection (5 DIs with NPN connection). Programmable
Input Updating Time	2 ms
3 relay outputs	Maximum switching voltage 250 V AC/30 V DC. Maximum continuous current 2 A rms. Programmable, Form C
Contact material	Silver Tin Oxide (AgSnO ₂)
PTC, PT100 and PT1000	Any of the analog inputs, or digital input 6, are configurable for PTC with up to 6 sensors.
Adjustable filters on analog inputs and outputs	
All control inputs isolated from ground and power	
Operation	
Air temperature	-15 to +50 °C (5 to 122 °F). -15 to 0 °C (5 to 32 °F): No frost allowed. Output derated above +40 °C (104 °F)
Installation site altitude	0 to 4000 m (13123 ft) above sea level Output derated above 1000 m (3281 ft)
Relative humidity	5 to 95%: No condensation allowed Maximum relative humidity is 60% in the presence of corrosive gasses
Atmospheric pressure	70 to 106 kPa (10.2 to 15.4 PSI) 0.7 to 1.05 atmospheres
Vibration	Risk category IV Certified (IBC 2018)

Environmental protections	
Chemical Gasses	Class 3C2
Solid Particles	Class 3S2 No conductive dust allowed
Pollution degree (IEC/EN 61800-5-1)	Pollution degree 2
Product compliance	
Standards and directives	<p>Low Voltage Directive 2006/95/EC EMC Directive 2004/108/EC 60721-3-3: 2002 60721-3-1:1997 Quality assurance system ISO 9001 and Environmental system ISO 14001 CE, UL, cUL, and EAC approvals Galvanic isolation according to PELV RoHS2 (Restriction of Hazardous Substances) EN 61800-5-1: 2007; IEC/EN 61000-3-12; EN61800-3: 2017 + A1: 2012 Category C2 (1st environment restricted distribution); Safe torque off (EN 61800-5-2) BACnet Testing Laboratory (BTL) Seismic (IBC, OSHPD) Plenum rated</p>
EMC (according to EN61800-3)	ACH580-01 and ACH580-31 class C2 (1st environment restricted distribution)
Storage (in Protective Shipping Package)	
Air Temperature	-40 to +70 °C (-40 to +158 °F)
Relative Humidity	Less than 95% No condensation allowed Maximum relative humidity is 60% in the presence of corrosive gasses
Chemical Gasses	Class 1C2
Solid Particles	Class 1S2 Contact ABB regarding Class 1S3
Atmospheric pressure	70 to 106 kPa 0.7 to 1.05 atmospheres
Vibration (ISTA)	
R1...R4	In accordance with ISTA 1A
R5...R9	In accordance with ISTA 3E

Transportation (in Protective Shipping Package)	
Air Temperature	-40° to 70°C (-40° to 158°F)
Relative Humidity	Less than 95% No condensation allowed Maximum relative humidity is 60% in the presence of corrosive gasses
Atmospheric Pressure	60 to 106 kPa (8.7 to 15.4 PSI) 0.6 to 1.05 atmospheres
Free Fall	R1: 76 cm (30 in) R2: 61 cm (24 in) R3: 46 cm (18 in) R4: 31 cm (12 in) R5: 25 cm (10 in)
Chemical Gasses	Class 2C2
Solid Particles	Class 2S2
Shock/ Drop (ISTA)	
R1...R4	In accordance with ISTA 1A
R5...R9	In accordance with ISTA 3E
Vibration (ISTA)	
R1...R4	In accordance with ISTA 1A
R5...R9	In accordance with ISTA 3E

How to select a drive

This is how you build up your own ordering code using the type designation key.

Start by identifying your supply voltage.
This tells you what rating table to use.
See pages 19-26.

Select your drive's order code from the rating table based on the nominal current rating of your motor.

Ratings, types and voltages
ACH580-01, wall-mounted drives

Type Code	Nominal Output Rating ¹⁾ Current A	Power kW	Frame Size	Drive Ref. UL Type 1	Drive Ref. UL Type 1 ABB4
U_N = 208 to 240 V Power ratings are valid at nominal output voltage U_N = 208/230 V 50/60 Hz					
ACH580-0104A-2	4.5	1.5	R1	01-04A	01-04A
ACH580-0104A-3	6.0	2.0	R1	01-04A	01-04A
ACH580-0104A-4	7.5	2.5	R1	01-04A	01-04A
ACH580-0104A-5	9.0	3.0	R1	01-04A	01-04A
ACH580-0104A-6	10.5	3.5	R1	01-04A	01-04A
ACH580-0104A-7	12.0	4.0	R1	01-04A	01-04A
ACH580-0104A-8	13.5	4.5	R1	01-04A	01-04A
ACH580-0104A-9	15.0	5.0	R1	01-04A	01-04A
ACH580-0104A-10	16.5	5.5	R1	01-04A	01-04A
ACH580-0104A-11	18.0	6.0	R1	01-04A	01-04A
ACH580-0104A-12	19.5	6.5	R1	01-04A	01-04A
ACH580-0104A-13	21.0	7.0	R1	01-04A	01-04A
ACH580-0104A-14	22.5	7.5	R1	01-04A	01-04A
ACH580-0104A-15	24.0	8.0	R1	01-04A	01-04A
ACH580-0104A-16	25.5	8.5	R1	01-04A	01-04A
ACH580-0104A-17	27.0	9.0	R1	01-04A	01-04A
ACH580-0104A-18	28.5	9.5	R1	01-04A	01-04A
ACH580-0104A-19	30.0	10.0	R1	01-04A	01-04A
ACH580-0104A-20	31.5	10.5	R1	01-04A	01-04A
ACH580-0104A-21	33.0	11.0	R1	01-04A	01-04A
ACH580-0104A-22	34.5	11.5	R1	01-04A	01-04A
ACH580-0104A-23	36.0	12.0	R1	01-04A	01-04A
ACH580-0104A-24	37.5	12.5	R1	01-04A	01-04A
ACH580-0104A-25	39.0	13.0	R1	01-04A	01-04A
ACH580-0104A-26	40.5	13.5	R1	01-04A	01-04A
ACH580-0104A-27	42.0	14.0	R1	01-04A	01-04A
ACH580-0104A-28	43.5	14.5	R1	01-04A	01-04A
ACH580-0104A-29	45.0	15.0	R1	01-04A	01-04A
ACH580-0104A-30	46.5	15.5	R1	01-04A	01-04A
ACH580-0104A-31	48.0	16.0	R1	01-04A	01-04A
ACH580-0104A-32	49.5	16.5	R1	01-04A	01-04A
ACH580-0104A-33	51.0	17.0	R1	01-04A	01-04A
ACH580-0104A-34	52.5	17.5	R1	01-04A	01-04A
ACH580-0104A-35	54.0	18.0	R1	01-04A	01-04A
ACH580-0104A-36	55.5	18.5	R1	01-04A	01-04A
ACH580-0104A-37	57.0	19.0	R1	01-04A	01-04A
ACH580-0104A-38	58.5	19.5	R1	01-04A	01-04A
ACH580-0104A-39	60.0	20.0	R1	01-04A	01-04A
ACH580-0104A-40	61.5	20.5	R1	01-04A	01-04A
ACH580-0104A-41	63.0	21.0	R1	01-04A	01-04A
ACH580-0104A-42	64.5	21.5	R1	01-04A	01-04A
ACH580-0104A-43	66.0	22.0	R1	01-04A	01-04A
ACH580-0104A-44	67.5	22.5	R1	01-04A	01-04A
ACH580-0104A-45	69.0	23.0	R1	01-04A	01-04A
ACH580-0104A-46	70.5	23.5	R1	01-04A	01-04A
ACH580-0104A-47	72.0	24.0	R1	01-04A	01-04A
ACH580-0104A-48	73.5	24.5	R1	01-04A	01-04A
ACH580-0104A-49	75.0	25.0	R1	01-04A	01-04A
ACH580-0104A-50	76.5	25.5	R1	01-04A	01-04A
ACH580-0104A-51	78.0	26.0	R1	01-04A	01-04A
ACH580-0104A-52	79.5	26.5	R1	01-04A	01-04A
ACH580-0104A-53	81.0	27.0	R1	01-04A	01-04A
ACH580-0104A-54	82.5	27.5	R1	01-04A	01-04A
ACH580-0104A-55	84.0	28.0	R1	01-04A	01-04A
ACH580-0104A-56	85.5	28.5	R1	01-04A	01-04A
ACH580-0104A-57	87.0	29.0	R1	01-04A	01-04A
ACH580-0104A-58	88.5	29.5	R1	01-04A	01-04A
ACH580-0104A-59	90.0	30.0	R1	01-04A	01-04A
ACH580-0104A-60	91.5	30.5	R1	01-04A	01-04A
ACH580-0104A-61	93.0	31.0	R1	01-04A	01-04A
ACH580-0104A-62	94.5	31.5	R1	01-04A	01-04A
ACH580-0104A-63	96.0	32.0	R1	01-04A	01-04A
ACH580-0104A-64	97.5	32.5	R1	01-04A	01-04A
ACH580-0104A-65	99.0	33.0	R1	01-04A	01-04A
ACH580-0104A-66	100.5	33.5	R1	01-04A	01-04A
ACH580-0104A-67	102.0	34.0	R1	01-04A	01-04A
ACH580-0104A-68	103.5	34.5	R1	01-04A	01-04A
ACH580-0104A-69	105.0	35.0	R1	01-04A	01-04A
ACH580-0104A-70	106.5	35.5	R1	01-04A	01-04A
ACH580-0104A-71	108.0	36.0	R1	01-04A	01-04A
ACH580-0104A-72	109.5	36.5	R1	01-04A	01-04A
ACH580-0104A-73	111.0	37.0	R1	01-04A	01-04A
ACH580-0104A-74	112.5	37.5	R1	01-04A	01-04A
ACH580-0104A-75	114.0	38.0	R1	01-04A	01-04A
ACH580-0104A-76	115.5	38.5	R1	01-04A	01-04A
ACH580-0104A-77	117.0	39.0	R1	01-04A	01-04A
ACH580-0104A-78	118.5	39.5	R1	01-04A	01-04A
ACH580-0104A-79	120.0	40.0	R1	01-04A	01-04A
ACH580-0104A-80	121.5	40.5	R1	01-04A	01-04A
ACH580-0104A-81	123.0	41.0	R1	01-04A	01-04A
ACH580-0104A-82	124.5	41.5	R1	01-04A	01-04A
ACH580-0104A-83	126.0	42.0	R1	01-04A	01-04A
ACH580-0104A-84	127.5	42.5	R1	01-04A	01-04A
ACH580-0104A-85	129.0	43.0	R1	01-04A	01-04A
ACH580-0104A-86	130.5	43.5	R1	01-04A	01-04A
ACH580-0104A-87	132.0	44.0	R1	01-04A	01-04A
ACH580-0104A-88	133.5	44.5	R1	01-04A	01-04A
ACH580-0104A-89	135.0	45.0	R1	01-04A	01-04A
ACH580-0104A-90	136.5	45.5	R1	01-04A	01-04A
ACH580-0104A-91	138.0	46.0	R1	01-04A	01-04A
ACH580-0104A-92	139.5	46.5	R1	01-04A	01-04A
ACH580-0104A-93	141.0	47.0	R1	01-04A	01-04A
ACH580-0104A-94	142.5	47.5	R1	01-04A	01-04A
ACH580-0104A-95	144.0	48.0	R1	01-04A	01-04A
ACH580-0104A-96	145.5	48.5	R1	01-04A	01-04A
ACH580-0104A-97	147.0	49.0	R1	01-04A	01-04A
ACH580-0104A-98	148.5	49.5	R1	01-04A	01-04A
ACH580-0104A-99	150.0	50.0	R1	01-04A	01-04A
ACH580-0104A-100	151.5	50.5	R1	01-04A	01-04A
ACH580-0104A-101	153.0	51.0	R1	01-04A	01-04A
ACH580-0104A-102	154.5	51.5	R1	01-04A	01-04A
ACH580-0104A-103	156.0	52.0	R1	01-04A	01-04A
ACH580-0104A-104	157.5	52.5	R1	01-04A	01-04A
ACH580-0104A-105	159.0	53.0	R1	01-04A	01-04A
ACH580-0104A-106	160.5	53.5	R1	01-04A	01-04A
ACH580-0104A-107	162.0	54.0	R1	01-04A	01-04A
ACH580-0104A-108	163.5	54.5	R1	01-04A	01-04A
ACH580-0104A-109	165.0	55.0	R1	01-04A	01-04A
ACH580-0104A-110	166.5	55.5	R1	01-04A	01-04A
ACH580-0104A-111	168.0	56.0	R1	01-04A	01-04A
ACH580-0104A-112	169.5	56.5	R1	01-04A	01-04A
ACH580-0104A-113	171.0	57.0	R1	01-04A	01-04A
ACH580-0104A-114	172.5	57.5	R1	01-04A	01-04A
ACH580-0104A-115	174.0	58.0	R1	01-04A	01-04A
ACH580-0104A-116	175.5	58.5	R1	01-04A	01-04A
ACH580-0104A-117	177.0	59.0	R1	01-04A	01-04A
ACH580-0104A-118	178.5	59.5	R1	01-04A	01-04A
ACH580-0104A-119	180.0	60.0	R1	01-04A	01-04A
ACH580-0104A-120	181.5	60.5	R1	01-04A	01-04A
ACH580-0104A-121	183.0	61.0	R1	01-04A	01-04A
ACH580-0104A-122	184.5	61.5	R1	01-04A	01-04A
ACH580-0104A-123	186.0	62.0	R1	01-04A	01-04A
ACH580-0104A-124	187.5	62.5	R1	01-04A	01-04A
ACH580-0104A-125	189.0	63.0	R1	01-04A	01-04A
ACH580-0104A-126	190.5	63.5	R1	01-04A	01-04A
ACH580-0104A-127	192.0	64.0	R1	01-04A	01-04A
ACH580-0104A-128	193.5	64.5	R1	01-04A	01-04A
ACH580-0104A-129	195.0	65.0	R1	01-04A	01-04A
ACH580-0104A-130	196.5	65.5	R1	01-04A	01-04A
ACH580-0104A-131	198.0	66.0	R1	01-04A	01-04A
ACH580-0104A-132	199.5	66.5	R1	01-04A	01-04A
ACH580-0104A-133	201.0	67.0	R1	01-04A	01-04A
ACH580-0104A-134	202.5	67.5	R1	01-04A	01-04A
ACH580-0104A-135	204.0	68.0	R1	01-04A	01-04A
ACH580-0104A-136	205.5	68.5	R1	01-04A	01-04A
ACH580-0104A-137	207.0	69.0	R1	01-04A	01-04A
ACH580-0104A-138	208.5	69.5	R1	01-04A	01-04A
ACH580-0104A-139	210.0	70.0	R1	01-04A	01-04A
ACH580-0104A-140	211.5	70.5	R1	01-04A	01-04A
ACH580-0104A-141	213.0	71.0	R1	01-04A	01-04A
ACH580-0104A-142	214.5	71.5	R1	01-04A	01-04A
ACH580-0104A-143	216.0	72.0	R1	01-04A	01-04A
ACH580-0104A-144	217.5	72.5	R1	01-04A	01-04A
ACH580-0104A-145	219.0	73.0	R1	01-04A	01-04A
ACH580-0104A-146	220.5	73.5	R1	01-04A	01-04A
ACH580-0104A-147	222.0	74.0	R1	01-04A	01-04A
ACH580-0104A-148	223.5	74.5	R1	01-04A	01-04A
ACH580-0104A-149	225.0	75.0	R1	01-04A	01-04A
ACH580-0104A-150	226.5	75.5	R1	01-04A	01-04A
ACH580-0104A-151	228.0	76.0	R1	01-04A	01-04A
ACH580-0104A-152	229.5	76.5	R1	01-04A	01-04A
ACH580-0104A-153	231.0	77.0	R1	01-04A	01-04A
ACH580-0104A-154	232.5	77.5	R1	01-04A	01-04A
ACH580-0104A-155	234.0	78.0	R1	01-04A	01-04A
ACH580-0104A-156	235.5	78.5	R1	01-04A	01-04A
ACH580-0104A-157	237.0	79.0	R1	01-04A	01-04A
ACH580-0104A-158	238.5	79.5	R1	01-04A	01-04A
ACH580-0104A-159	240.0	80.0	R1	01-04A	01-04A
ACH580-0104A-160	241.5	80.5	R1	01-04A	01-04A
ACH580-0104A-161	243.0	81.0	R1	01-04A	01-04A
ACH580-0104A-162	244.5	81.5	R1	01-04A	01-04A
ACH580-0104A-163	246.0	82.0	R1	01-04A	01-04A
ACH580-0104A-164	247.5	82.5	R1	01-04A	01-04A
ACH580-0104A-165	249.0	83.0	R1	01-04A	01-04A
ACH580-0104A-166	250.5	83.5	R1	01-04A	01-04A
ACH580-0104A-167	252.0	84.0	R1	01-04A	01-04A
ACH580-0104A-168	253.5	84.5	R1	01-04A	01-04A
ACH580-0104A-169	255.0	85.0	R1	01-04A	01-04A
ACH580-0104A-170	256.5	85.5	R1	01-04A	01-04A
ACH580-0104A-171	258.0	86.0	R1</		

Ratings, types and voltages

ACH580-01, wall-mounted drives

Type Code	Nominal Output Ratings ¹⁾		Frame Size	Dim Ref UL Type 1	Dim Ref UL Type 12 +B056
	Current A	Power HP			
U₁ = 200 to 240 V. Power ratings are valid at nominal output voltage U_N = 208/230 V 60 Hz					
ACH580-01-04A6-2	4.6	1	R1	01-1-R1	01-12-R1
ACH580-01-06A6-2	6.6	1.5	R1	01-1-R1	01-12-R1
ACH580-01-07A5-2	7.5	2	R1	01-1-R1	01-12-R1
ACH580-01-10A6-2	10.6	3	R1	01-1-R1	01-12-R1
ACH580-01-017A-2	16.7	5	R1	01-1-R1	01-12-R1
ACH580-01-024A-2	24.2	7.5	R2	01-1-R2	01-12-R2
ACH580-01-031A-2	30.8	10	R2	01-1-R2	01-12-R2
ACH580-01-046A-2	46.2	15	R3	01-1-R3	01-12-R3
ACH580-01-059A-2	59.4	20	R3	01-1-R3	01-12-R3
ACH580-01-075A-2	74.8	25	R4	01-1-R4	01-12-R4
ACH580-01-088A-2	88	30	R5	01-1-R5	01-12-R5
ACH580-01-114A-2	114	40	R5	01-1-R5	01-12-R5
ACH580-01-143A-2	143	50	R6	01-1-R6	01-12-R6
ACH580-01-169A-2	169	60	R7	01-1-R7	01-12-R7
ACH580-01-211A-2	211	75	R7	01-1-R7	01-12-R7
ACH580-01-273A-2	273	100	R8	01-1-R8	01-12-R8
U₁ = 440 to 480 V. Power ratings are valid at nominal output voltage U_N = 460 V 60 Hz					
ACH580-01-02A1-4	2.1	1	R1	01-1-R1	01-12-R1
ACH580-01-03A0-4	3.0	1.5	R1	01-1-R1	01-12-R1
ACH580-01-03A5-4	3.5	2	R1	01-1-R1	01-12-R1
ACH580-01-04A8-4	4.8	3	R1	01-1-R1	01-12-R1
ACH580-01-07A6-4	7.6	5	R1	01-1-R1	01-12-R1
ACH580-01-012A-4	12	7.5	R1	01-1-R1	01-12-R1
ACH580-01-014A-4	14	10	R2	01-1-R2	01-12-R2
ACH580-01-023A-4	23	15	R2	01-1-R2	01-12-R2
ACH580-01-027A-4	27	20	R3	01-1-R3	01-12-R3
ACH580-01-034A-4	34	25	R3	01-1-R3	01-12-R3
ACH580-01-044A-4	44	30	R3	01-1-R3	01-12-R3
ACH580-01-052A-4	52	40	R4	01-1-R4	01-12-R4
ACH580-01-065A-4	65	50	R4	01-1-R4	01-12-R4
ACH580-01-077A-4	77	60	R4	01-1-R4	01-12-R4
ACH580-01-096A-4	96	75	R5	01-1-R5	01-12-R5
ACH580-01-124A-4	124	100	R6	01-1-R6	01-12-R6
ACH580-01-156A-4	156	125	R7	01-1-R7	01-12-R7
ACH580-01-180A-4	180	150	R7	01-1-R7	01-12-R7
ACH580-01-240A-4	240	200	R8	01-1-R8	01-12-R8
ACH580-01-302A-4	302	250	R9	01-1-R9	01-12-R9
ACH580-01-361A-4	361	300	R9	01-1-R9	01-12-R9
ACH580-01-414A-4	414	350	R9	01-1-R9	01-12-R9
U₁ = 500 to 600 V. Power ratings are valid at nominal output voltage U_N = 575 V 60 Hz					
ACH580-01-02A7-6	2.7	2	R2	01-1-R2	01-12-R2
ACH580-01-03A9-6	3.9	3	R2	01-1-R2	01-12-R2
ACH580-01-06A1-6	6.1	5	R2	01-1-R2	01-12-R2
ACH580-01-09A0-6	9.0	7.5	R2	01-1-R2	01-12-R2
ACH580-01-011A-6	11	10	R2	01-1-R2	01-12-R2
ACH580-01-017A-6	17	15	R2	01-1-R2	01-12-R2
ACH580-01-022A-6	22	20	R3	01-1-R3	01-12-R3
ACH580-01-027A-6	27	25	R3	01-1-R3	01-12-R3
ACH580-01-032A-6	32	30	R3	01-1-R3	01-12-R3
ACH580-01-041A-6	41	40	R5	01-1-R5	01-12-R5
ACH580-01-052A-6	52	50	R5	01-1-R5	01-12-R5
ACH580-01-062A-6	62	60	R5	01-1-R5	01-12-R5
ACH580-01-077A-6	77	75	R5	01-1-R5	01-12-R5
ACH580-01-099A-6	99	100	R7	01-1-R7	01-12-R7
ACH580-01-125A-6	125	125	R7	01-1-R7	01-12-R7
ACH580-01-144A-6	144	150	R8	01-1-R8	01-12-R8
ACH580-01-192A-6	192	200	R9	01-1-R9	01-12-R9
ACH580-01-242A-6	242	250	R9	01-1-R9	01-12-R9
ACH580-01-271A-6	271	250	R9	01-1-R9	01-12-R9

¹⁾ See notes and definitions on page 18.

Ratings, types and voltages

ACH580-VCR, vertical E-Clipse bypass drive with circuit breaker

Type Code	Nominal Output Ratings ¹⁾		Frame Size	Dim Ref UL Type1
	Drive Current	Package Power		
	A	HP		
U₁ = 200 to 240 V. Power ratings are valid at nominal output voltage U_N = 208/230 V 60 Hz				
ACH580-VCR-04A6-2	4.6	1	R1	Vx1-1
ACH580-VCR-06A6-2	6.6	1.5	R1	Vx1-1
ACH580-VCR-07A5-2	7.5	2	R1	Vx1-1
ACH580-VCR-10A6-2	10.6	3	R1	Vx1-1
ACH580-VCR-017A-2	16.7	5	R1	Vx1-1
ACH580-VCR-024A-2	24.2	7.5	R2	Vx1-2
ACH580-VCR-031A-2	30.8	10	R2	Vx1-3
ACH580-VCR-046A-2	46.2	15	R3	Vx1-4
ACH580-VCR-059A-2	59.4	20	R3	Vx1-4
ACH580-VCR-075A-2	74.8	25	R4	Vx1-4
U₁ = 440 to 480 V. Power ratings are valid at nominal output voltage U_N = 460 V 60 Hz				
ACH580-VCR-02A1-4	2.1	1	R1	Vx1-1
ACH580-VCR-03A0-4	3.0	1.5	R1	Vx1-1
ACH580-VCR-03A5-4	3.5	2	R1	Vx1-1
ACH580-VCR-04A8-4	4.8	3	R1	Vx1-1
ACH580-VCR-07A6-4	7.6	5	R1	Vx1-1
ACH580-VCR-012A-4	12	7.5	R1	Vx1-1
ACH580-VCR-014A-4	14	10	R2	Vx1-2
ACH580-VCR-023A-4	23	15	R2	Vx1-2
ACH580-VCR-027A-4	27	20	R3	Vx1-3
ACH580-VCR-034A-4	34	25	R3	Vx1-3
ACH580-VCR-044A-4	44	30	R3	Vx1-3
ACH580-VCR-052A-4	52	40	R4	Vx1-4
ACH580-VCR-065A-4	65	50	R4	Vx1-4
ACH580-VCR-077A-4	77	60	R4	Vx1-4
U₁ = 500 to 600 V. Power ratings are valid at nominal output voltage U_N = 575 V 60 Hz				
ACH580-VCR-02A7-6	2.7	2	R2	Vx1-2
ACH580-VCR-03A9-6	3.9	3	R2	Vx1-2
ACH580-VCR-06A1-6	6.1	5	R2	Vx1-2
ACH580-VCR-09A0-6	9.0	7.5	R2	Vx1-2
ACH580-VCR-011A-6	11	10	R2	Vx1-2
ACH580-VCR-017A-6	17	15	R2	Vx1-2
ACH580-VCR-022A-6	22	20	R3	Vx1-3
ACH580-VCR-027A-6	27	25	R3	Vx1-3
ACH580-VCR-032A-6	32	30	R3	Vx1-3

¹⁾ See notes and definitions on page 18.

Ratings, types and voltages

ACH580-VDR, vertical E-Clipse bypass drive with non-fused disconnect switch

Type Code	Nominal Output Ratings ¹⁾		Frame Size	Dim Ref UL Type 1
	Drive Current	Package Power		
	A	HP		
U_i = 200 to 240 V. Power ratings are valid at nominal output voltage U_N = 208/230 V 60 Hz				
ACH580-VDR-04A6-2	4.6	1	R1	Vx1-1
ACH580-VDR-06A6-2	6.6	1.5	R1	Vx1-1
ACH580-VDR-07A5-2	7.5	2	R1	Vx1-1
ACH580-VDR-10A6-2	10.6	3	R1	Vx1-1
ACH580-VDR-017A-2	16.7	5	R1	Vx1-1
ACH580-VDR-024A-2	24.2	7.5	R2	Vx1-2
ACH580-VDR-031A-2	30.8	10	R2	Vx1-3
ACH580-VDR-046A-2	46.2	15	R3	Vx1-4
ACH580-VDR-059A-2	59.4	20	R3	Vx1-4
ACH580-VDR-075A-2	74.8	25	R4	Vx1-4
U_i = 440 to 480 V. Power ratings are valid at nominal output voltage U_N = 460 V 60 Hz				
ACH580-VDR-02A1-4	2.1	1	R1	Vx1-1
ACH580-VDR-03A0-4	3.0	1.5	R1	Vx1-1
ACH580-VDR-03A5-4	3.5	2	R1	Vx1-1
ACH580-VDR-04A8-4	4.8	3	R1	Vx1-1
ACH580-VDR-07A6-4	7.6	5	R1	Vx1-1
ACH580-VDR-012A-4	12	7.5	R1	Vx1-1
ACH580-VDR-014A-4	14	10	R2	Vx1-2
ACH580-VDR-023A-4	23	15	R2	Vx1-2
ACH580-VDR-027A-4	27	20	R3	Vx1-3
ACH580-VDR-034A-4	34	25	R3	Vx1-3
ACH580-VDR-044A-4	44	30	R3	Vx1-3
ACH580-VDR-052A-4	52	40	R4	Vx1-4
ACH580-VDR-065A-4	65	50	R4	Vx1-4
ACH580-VDR-077A-4	77	60	R4	Vx1-4
U_i = 500 to 600 V. Power ratings are valid at nominal output voltage U_N = 575 V 60 Hz				
ACH580-VDR-02A7-6	2.7	2	R2	Vx1-2
ACH580-VDR-03A9-6	3.9	3	R2	Vx1-2
ACH580-VDR-06A1-6	6.1	5	R2	Vx1-2
ACH580-VDR-09A0-6	9.0	7.5	R2	Vx1-2
ACH580-VDR-011A-6	11	10	R2	Vx1-2
ACH580-VDR-017A-6	17	15	R2	Vx1-2
ACH580-VDR-022A-6	22	20	R3	Vx1-3
ACH580-VDR-027A-6	27	25	R3	Vx1-3
ACH580-VDR-032A-6	32	30	R3	Vx1-3

¹⁾ See notes and definitions on page 18.

Ratings, types and voltages

ACH580-BCR, E-Cclipse bypass drive with circuit breaker

Type Code	Nominal Output Ratings ¹⁾		Frame Size	Dim Ref UL Type 1	Dim Ref UL Type 12 +B056	Dim Ref NEMA 3R +B058
	Drive Current A	Package Power HP				
U_i = 200 to 240 V. Power ratings are valid at nominal output voltage U_N = 208/230 V 60 Hz						
ACH580-BCR-04A6-2	4.6	1	R1	Bx1-1	Bx12-1	Bx3R-1
ACH580-BCR-06A6-2	6.6	1.5	R1	Bx1-1	Bx12-1	Bx3R-1
ACH580-BCR-07A5-2	7.5	2	R1	Bx1-1	Bx12-1	Bx3R-1
ACH580-BCR-10A6-2	10.6	3	R1	Bx1-1	Bx12-1	Bx3R-1
ACH580-BCR-017A-2	16.7	5	R1	Bx1-1	Bx12-1	Bx3R-1
ACH580-BCR-024A-2	24.2	7.5	R2	Bx1-1	Bx12-1	Bx3R-1
ACH580-BCR-031A-2	30.8	10	R2	Bx1-2	Bx12-2	Bx3R-2
ACH580-BCR-046A-2	46.2	15	R3	Bx1-2	Bx12-2	Bx3R-2
ACH580-BCR-059A-2	59.4	20	R3	Bx1-2	Bx12-2	Bx3R-2
ACH580-BCR-075A-2	74.8	25	R4	Bx1-2	Bx12-2	Bx3R-2
ACH580-BCR-088A-2	88.0	30	R5	Bx1-3	Bx12-3	Bx3R-3
ACH580-BCR-114A-2	114	40	R5	Bx1-3	Bx12-3	Bx3R-3
ACH580-BCR-143A-2	143	50	R6	Bx1-3	Bx12-3	Bx3R-4
ACH580-BCR-169A-2	169	60	R7	Bx1-3	Bx12-3	Bx3R-4
ACH580-BCR-211A-2	211	75	R7	Bx1-3	Bx12-3	Bx3R-4
ACH580-BCR-248A-2	248	100 ²⁾	R8	Bx1-3	Bx12-3	Bx3R-5
U_i = 440 to 480 V. Power ratings are valid at nominal output voltage U_N = 460 V 60 Hz						
ACH580-BCR-02A1-4	2.1	1	R1	Bx1-1	Bx12-1	Bx3R-1
ACH580-BCR-03A0-4	3.0	1.5	R1	Bx1-1	Bx12-1	Bx3R-1
ACH580-BCR-03A5-4	3.5	2	R1	Bx1-1	Bx12-1	Bx3R-1
ACH580-BCR-04A8-4	4.8	3	R1	Bx1-1	Bx12-1	Bx3R-1
ACH580-BCR-07A6-4	7.6	5	R1	Bx1-1	Bx12-1	Bx3R-1
ACH580-BCR-012A-4	12	7.5	R1	Bx1-1	Bx12-1	Bx3R-1
ACH580-BCR-014A-4	14	10	R2	Bx1-1	Bx12-1	Bx3R-1
ACH580-BCR-023A-4	23	15	R2	Bx1-1	Bx12-1	Bx3R-1
ACH580-BCR-027A-4	27	20	R3	Bx1-2	Bx12-2	Bx3R-2
ACH580-BCR-034A-4	34	25	R3	Bx1-2	Bx12-2	Bx3R-2
ACH580-BCR-044A-4	44	30	R3	Bx1-2	Bx12-2	Bx3R-2
ACH580-BCR-052A-4	52	40	R4	Bx1-2	Bx12-2	Bx3R-2
ACH580-BCR-065A-4	65	50	R4	Bx1-2	Bx12-2	Bx3R-2
ACH580-BCR-077A-4	77	60	R4	Bx1-2	Bx12-2	Bx3R-2
ACH580-BCR-096A-4	96	75	R5	Bx1-3	Bx12-3	Bx3R-3
ACH580-BCR-124A-4	124	100	R6	Bx1-3	Bx12-3	Bx3R-4
ACH580-BCR-156A-4	156	125	R7	Bx1-3	Bx12-3	Bx3R-4
ACH580-BCR-180A-4	180	150	R7	Bx1-3	Bx12-3	Bx3R-4
ACH580-BCR-240A-4	240	200	R8	Bx1-3	Bx12-3	Bx3R-5
ACH580-BCR-302A-4	302	250	R9	Bx1-6	Bx12-6	Bx3R-6
ACH580-BCR-361A-4	361	300	R9	Bx1-6	Bx12-6	Bx3R-6
ACH580-BCR-414A-4	414	350	R9	Bx1-6	Bx12-6	Bx3R-6
U_i = 500 to 600 V. Power ratings are valid at nominal output voltage U_N = 575 V 60 Hz						
ACH580-BCR-02A7-6	2.7	2	R2	Bx1-1	Bx12-1	Bx3R-1
ACH580-BCR-03A9-6	3.9	3	R2	Bx1-1	Bx12-1	Bx3R-1
ACH580-BCR-06A1-6	6.1	5	R2	Bx1-1	Bx12-1	Bx3R-1
ACH580-BCR-09A0-6	9.0	7.5	R2	Bx1-1	Bx12-1	Bx3R-1
ACH580-BCR-011A-6	11	10	R2	Bx1-1	Bx12-1	Bx3R-1
ACH580-BCR-017A-6	17	15	R2	Bx1-1	Bx12-1	Bx3R-1
ACH580-BCR-022A-6	22	20	R3	Bx1-2	Bx12-2	Bx3R-2
ACH580-BCR-027A-6	27	25	R3	Bx1-2	Bx12-2	Bx3R-2
ACH580-BCR-032A-6	32	30	R3	Bx1-2	Bx12-2	Bx3R-2
ACH580-BCR-041A-6	41	40	R5	Bx1-3	Bx12-3	-
ACH580-BCR-052A-6	52	50	R5	Bx1-3	Bx12-3	-
ACH580-BCR-062A-6	62	60	R5	Bx1-3	Bx12-3	-
ACH580-BCR-077A-6	77	75	R5	Bx1-3	Bx12-3	-
ACH580-BCR-099A-6	99	100	R7	Bx1-3	Bx12-3	-
ACH580-BCR-125A-6	125	125	R7	Bx1-3	Bx12-3	-
ACH580-BCR-144A-6	144	150	R8	Bx1-3	Bx12-3	-

¹⁾ See notes and definitions on page 18.

²⁾ 100 HP at 230 V

Ratings, types and voltages

ACH580-BDR, E-Cclipse bypass drive with non-fused disconnect switch

Type Code	Nominal Output Ratings ¹⁾		Frame Size	Dim Ref UL Type 1	Dim Ref UL Type 12 +B056	Dim Ref NEMA 3R +B058
	Drive Current A	Package Power HP				
U₁ = 200 to 240 V. Power ratings are valid at nominal output voltage U_N = 208/230 V 60 Hz						
ACH580-BDR-04A6-2	4.6	1	R1	Bx1-1	Bx12-1	Bx3R-1
ACH580-BDR-06A6-2	6.6	1.5	R1	Bx1-1	Bx12-1	Bx3R-1
ACH580-BDR-07A5-2	7.5	2	R1	Bx1-1	Bx12-1	Bx3R-1
ACH580-BDR-10A6-2	10.6	3	R1	Bx1-1	Bx12-1	Bx3R-1
ACH580-BDR-017A-2	16.7	5	R1	Bx1-1	Bx12-1	Bx3R-1
ACH580-BDR-024A-2	24.2	7.5	R2	Bx1-1	Bx12-1	Bx3R-1
ACH580-BDR-031A-2	30.8	10	R2	Bx1-2	Bx12-2	Bx3R-2
ACH580-BDR-046A-2	46.2	15	R3	Bx1-2	Bx12-2	Bx3R-2
ACH580-BDR-059A-2	59.4	20	R3	Bx1-2	Bx12-2	Bx3R-2
ACH580-BDR-075A-2	74.8	25	R4	Bx1-2	Bx12-2	Bx3R-2
ACH580-BDR-088A-2	88.0	30	R5	Bx1-3	Bx12-3	Bx3R-3
ACH580-BDR-114A-2	114	40	R5	Bx1-3	Bx12-3	Bx3R-3
ACH580-BDR-143A-2	143	50	R6	Bx1-3	Bx12-3	Bx3R-4
ACH580-BDR-169A-2	169	60	R7	Bx1-3	Bx12-3	Bx3R-4
ACH580-BDR-211A-2	211	75	R7	Bx1-3	Bx12-3	Bx3R-4
ACH580-BDR-248A-2	248	100 ²⁾	R8	Bx1-3	Bx12-3	Bx3R-5
U₁ = 440 to 480 V. Power ratings are valid at nominal output voltage U_N = 460 V 60 Hz						
ACH580-BDR-02A1-4	2.1	1	R1	Bx1-1	Bx12-1	Bx3R-1
ACH580-BDR-03A0-4	3.0	1.5	R1	Bx1-1	Bx12-1	Bx3R-1
ACH580-BDR-03A5-4	3.5	2	R1	Bx1-1	Bx12-1	Bx3R-1
ACH580-BDR-04A8-4	4.8	3	R1	Bx1-1	Bx12-1	Bx3R-1
ACH580-BDR-07A6-4	7.6	5	R1	Bx1-1	Bx12-1	Bx3R-1
ACH580-BDR-012A-4	12	7.5	R1	Bx1-1	Bx12-1	Bx3R-1
ACH580-BDR-014A-4	14	10	R2	Bx1-1	Bx12-1	Bx3R-1
ACH580-BDR-023A-4	23	15	R2	Bx1-1	Bx12-1	Bx3R-1
ACH580-BDR-027A-4	27	20	R3	Bx1-2	Bx12-2	Bx3R-2
ACH580-BDR-034A-4	34	25	R3	Bx1-2	Bx12-2	Bx3R-2
ACH580-BDR-044A-4	44	30	R3	Bx1-2	Bx12-2	Bx3R-2
ACH580-BDR-052A-4	52	40	R4	Bx1-2	Bx12-2	Bx3R-2
ACH580-BDR-065A-4	65	50	R4	Bx1-2	Bx12-2	Bx3R-2
ACH580-BDR-077A-4	77	60	R4	Bx1-2	Bx12-2	Bx3R-2
ACH580-BDR-096A-4	96	75	R5	Bx1-3	Bx12-3	Bx3R-3
ACH580-BDR-124A-4	124	100	R6	Bx1-3	Bx12-3	Bx3R-4
ACH580-BDR-156A-4	156	125	R7	Bx1-3	Bx12-3	Bx3R-4
ACH580-BDR-180A-4	180	150	R7	Bx1-3	Bx12-3	Bx3R-4
ACH580-BDR-240A-4	240	200	R8	Bx1-3	Bx12-3	Bx3R-5
ACH580-BDR-302A-4	302	250	R9	Bx1-6	Bx12-6	Bx3R-6
ACH580-BDR-361A-4	361	300	R9	Bx1-6	Bx12-6	Bx3R-6
ACH580-BDR-414A-4	414	350	R9	Bx1-6	Bx12-6	Bx3R-6
U₁ = 500 to 600 V. Power ratings are valid at nominal output voltage U_N = 575 V 60 Hz						
ACH580-BDR-02A7-6	2.7	2	R2	Bx1-1	Bx12-1	Bx3R-1
ACH580-BDR-03A9-6	3.9	3	R2	Bx1-1	Bx12-1	Bx3R-1
ACH580-BDR-06A1-6	6.1	5	R2	Bx1-1	Bx12-1	Bx3R-1
ACH580-BDR-09A0-6	9.0	7.5	R2	Bx1-1	Bx12-1	Bx3R-1
ACH580-BDR-011A-6	11	10	R2	Bx1-1	Bx12-1	Bx3R-1
ACH580-BDR-017A-6	17	15	R2	Bx1-1	Bx12-1	Bx3R-1
ACH580-BDR-022A-6	22	20	R3	Bx1-2	Bx12-2	Bx3R-2
ACH580-BDR-027A-6	27	25	R3	Bx1-2	Bx12-2	Bx3R-2
ACH580-BDR-032A-6	32	30	R3	Bx1-2	Bx12-2	Bx3R-2
ACH580-BDR-041A-6	41	40	R5	Bx1-3	Bx12-3	-
ACH580-BDR-052A-6	52	50	R5	Bx1-3	Bx12-3	-
ACH580-BDR-062A-6	62	60	R5	Bx1-3	Bx12-3	-
ACH580-BDR-077A-6	77	75	R5	Bx1-3	Bx12-3	-
ACH580-BDR-099A-6	99	100	R7	Bx1-3	Bx12-3	-
ACH580-BDR-125A-6	125	125	R7	Bx1-3	Bx12-3	-
ACH580-BDR-144A-6	144	150	R8	Bx1-3	Bx12-3	-

¹⁾ See notes and definitions on page 18.

²⁾ 100 HP at 230 V

Ratings, types and voltages

ACH580-PCR, packaged drive with disconnect means with circuit breaker

Type Code	Nominal Output Ratings ¹⁾		Frame Size	Dim Ref UL Type 1	Dim Ref UL Type 12 +B056	Dim Ref NEMA 3R +B058
	Current	Power				
	A	HP				
U_i = 200 to 240 V. Power ratings are valid at nominal output voltage U_N = 208/230 V 60 Hz						
ACH580-PCR-04A6-2	4.6	1	R1	Px1-1	Px12-1	PxB3R-1
ACH580-PCR-06A6-2	6.6	1.5	R1	Px1-1	Px12-1	PxB3R-1
ACH580-PCR-07A5-2	7.5	2	R1	Px1-1	Px12-1	PxB3R-1
ACH580-PCR-10A6-2	10.6	3	R1	Px1-1	Px12-1	PxB3R-1
ACH580-PCR-017A-2	16.7	5	R1	Px1-1	Px12-1	PxB3R-1
ACH580-PCR-024A-2	24.2	7.5	R2	Px1-2	Px12-2	PxB3R-1
ACH580-PCR-031A-2	30.8	10	R2	Px1-2	Px12-2	PxB3R-1
ACH580-PCR-046A-2	46.2	15	R3	Px1-3	Px12-3	PxB3R-2
ACH580-PCR-059A-2	59.4	20	R3	Px1-3	Px12-3	PxB3R-2
ACH580-PCR-075A-2	74.8	25	R4	Px1-4	Px12-4	PxB3R-2
ACH580-PCR-088A-2	88.0	30	R5	PxB1-3	PxB12-3	PxB3R-3
ACH580-PCR-114A-2	114	40	R6	PxB1-3	PxB12-3	PxB3R-3
ACH580-PCR-143A-2	143	50	R6	PxB1-3	PxB12-3	PxB3R-4
ACH580-PCR-169A-2	169	60	R7	PxB1-3	PxB12-3	PxB3R-4
ACH580-PCR-211A-2	211	75	R7	PxB1-3	PxB12-3	PxB3R-4
ACH580-PCR-248A-2	248	100 ²⁾	R8	PxB1-3	PxB12-3	PxB3R-4
U_i = 380 to 480 V. Power ratings are valid at nominal output voltage U_N = 460 V 60 Hz						
ACH580-PCR-02A1-4	2.1	1	R1	Px1-1	Px12-1	PxB3R-1
ACH580-PCR-03A0-4	3.0	1.5	R1	Px1-1	Px12-1	PxB3R-1
ACH580-PCR-03A5-4	3.5	2	R1	Px1-1	Px12-1	PxB3R-1
ACH580-PCR-04A8-4	4.8	3	R1	Px1-1	Px12-1	PxB3R-1
ACH580-PCR-07A6-4	7.6	5	R1	Px1-1	Px12-1	PxB3R-1
ACH580-PCR-012A-4	12	7.5	R1	Px1-1	Px12-1	PxB3R-1
ACH580-PCR-014A-4	14	10	R2	Px1-2	Px12-2	PxB3R-1
ACH580-PCR-023A-4	23	15	R2	Px1-2	Px12-2	PxB3R-1
ACH580-PCR-027A-4	27	20	R3	Px1-3	Px12-3	PxB3R-2
ACH580-PCR-034A-4	34	25	R3	Px1-3	Px12-3	PxB3R-2
ACH580-PCR-044A-4	44	30	R3	Px1-3	Px12-3	PxB3R-2
ACH580-PCR-052A-4	52	40	R4	Px1-4	Px12-4	PxB3R-2
ACH580-PCR-065A-4	65	50	R4	Px1-4	Px12-4	PxB3R-2
ACH580-PCR-077A-4	77	60	R4	Px1-4	Px12-4	PxB3R-2
ACH580-PCR-096A-4	96	75	R5	PxB1-3	PxB12-3	PxB3R-3
ACH580-PCR-124A-4	124	100	R6	PxB1-3	PxB12-3	PxB3R-4
ACH580-PCR-156A-4	156	125	R7	PxB1-3	PxB12-3	PxB3R-4
ACH580-PCR-180A-4	180	150	R7	PxB1-3	PxB12-3	PxB3R-4
ACH580-PCR-240A-4	240	200	R8	PxB1-3	PxB12-3	PxB3R-4
ACH580-PCR-302A-4	302	250	R9	PxB1-6	PxB12-6	PxB3R-5
ACH580-PCR-361A-4	361	300	R9	PxB1-6	PxB12-6	PxB3R-5
ACH580-PCR-414A-4	414	350	R9	PxB1-6	PxB12-6	PxB3R-5
U_i = 500 to 600 V. Power ratings are valid at nominal output voltage U_N = 575 V 60 Hz						
ACH580-PCR-02A7-6	2.7	2	R2	Px1-2	Px12-2	PxB3R-1
ACH580-PCR-03A9-6	3.9	3	R2	Px1-2	Px12-2	PxB3R-1
ACH580-PCR-06A1-6	6.1	5	R2	Px1-2	Px12-2	PxB3R-1
ACH580-PCR-09A0-6	9.0	7.5	R2	Px1-2	Px12-2	PxB3R-1
ACH580-PCR-011A-6	11	10	R2	Px1-2	Px12-2	PxB3R-1
ACH580-PCR-017A-6	17	15	R2	Px1-2	Px12-2	PxB3R-1
ACH580-PCR-022A-6	22	20	R3	Px1-3	Px12-3	PxB3R-2
ACH580-PCR-027A-6	27	25	R3	Px1-3	Px12-3	PxB3R-2
ACH580-PCR-032A-6	32	30	R3	Px1-3	Px12-3	PxB3R-2
ACH580-PCR-041A-6	41	40	R5	PxB1-3	PxB12-3	-
ACH580-PCR-052A-6	52	50	R5	PxB1-3	PxB12-3	-
ACH580-PCR-062A-6	62	60	R5	PxB1-3	PxB12-3	-
ACH580-PCR-077A-6	77	75	R5	PxB1-3	PxB12-3	-
ACH580-PCR-099A-6	99	100	R7	PxB1-3	PxB12-3	-
ACH580-PCR-125A-6	125	125	R7	PxB1-3	PxB12-3	-
ACH580-PCR-144A-6	144	150	R8	PxB1-3	PxB12-3	-

¹⁾ See notes and definitions on page 18.

²⁾ 100 HP at 230 V

Ratings, types and voltages

ACH580-PDR, packaged drive with disconnect means with non-fused disconnect switch

Type Code	Nominal Output Ratings ¹⁾		Frame Size	Dim Ref UL Type 1	Dim Ref UL Type 12 +B056	Dim Ref NEMA 3R +B058
	Current	Power				
	A	HP				
U_i = 200 to 240 V. Power ratings are valid at nominal output voltage U_N = 208/230 V 60 Hz						
ACH580-PDR-04A6-2	4.6	1	R1	Px1-1	Px12-1	PxB3R-1
ACH580-PDR-06A6-2	6.6	1.5	R1	Px1-1	Px12-1	PxB3R-1
ACH580-PDR-07A5-2	7.5	2	R1	Px1-1	Px12-1	PxB3R-1
ACH580-PDR-10A6-2	10.6	3	R1	Px1-1	Px12-1	PxB3R-1
ACH580-PDR-017A-2	16.7	5	R1	Px1-1	Px12-1	PxB3R-1
ACH580-PDR-024A-2	24.2	7.5	R2	Px1-2	Px12-2	PxB3R-1
ACH580-PDR-031A-2	30.8	10	R2	Px1-2	Px12-2	PxB3R-1
ACH580-PDR-046A-2	46.2	15	R3	Px1-3	Px12-3	PxB3R-2
ACH580-PDR-059A-2	59.4	20	R3	Px1-3	Px12-3	PxB3R-2
ACH580-PDR-075A-2	74.8	25	R4	Px1-4	Px12-4	PxB3R-2
ACH580-PDR-088A-2	88.0	30	R5	PxB1-3	PxB12-3	PxB3R-3
ACH580-PDR-114A-2	114	40	R5	PxB1-3	PxB12-3	PxB3R-3
ACH580-PDR-143A-2	143	50	R6	PxB1-3	PxB12-3	PxB3R-4
ACH580-PDR-169A-2	169	60	R7	PxB1-3	PxB12-3	PxB3R-4
ACH580-PDR-211A-2	211	75	R7	PxB1-3	PxB12-3	PxB3R-4
ACH580-PDR-248A-2	248	100 ²⁾	R8	PxB1-3	PxB12-3	PxB3R-4
U_i = 380 to 480 V. Power ratings are valid at nominal output voltage U_N = 460 V 60 Hz						
ACH580-PDR-02A1-4	2.1	1	R1	Px1-1	Px12-1	PxB3R-1
ACH580-PDR-03A0-4	3.0	1.5	R1	Px1-1	Px12-1	PxB3R-1
ACH580-PDR-03A5-4	3.5	2	R1	Px1-1	Px12-1	PxB3R-1
ACH580-PDR-04A8-4	4.8	3	R1	Px1-1	Px12-1	PxB3R-1
ACH580-PDR-07A6-4	7.6	5	R1	Px1-1	Px12-1	PxB3R-1
ACH580-PDR-012A-4	12	7.5	R1	Px1-1	Px12-1	PxB3R-1
ACH580-PDR-014A-4	14	10	R2	Px1-2	Px12-2	PxB3R-1
ACH580-PDR-023A-4	23	15	R2	Px1-2	Px12-2	PxB3R-1
ACH580-PDR-027A-4	27	20	R3	Px1-3	Px12-3	PxB3R-2
ACH580-PDR-034A-4	34	25	R3	Px1-3	Px12-3	PxB3R-2
ACH580-PDR-044A-4	44	30	R3	Px1-3	Px12-3	PxB3R-2
ACH580-PDR-052A-4	52	40	R4	Px1-4	Px12-4	PxB3R-2
ACH580-PDR-065A-4	65	50	R4	Px1-4	Px12-4	PxB3R-2
ACH580-PDR-077A-4	77	60	R4	Px1-4	Px12-4	PxB3R-2
ACH580-PDR-096A-4	96	75	R5	PxB1-3	PxB12-3	PxB3R-3
ACH580-PDR-124A-4	124	100	R6	PxB1-3	PxB12-3	PxB3R-4
ACH580-PDR-156A-4	156	125	R7	PxB1-3	PxB12-3	PxB3R-4
ACH580-PDR-180A-4	180	150	R7	PxB1-3	PxB12-3	PxB3R-4
ACH580-PDR-240A-4	240	200	R8	PxB1-3	PxB12-3	PxB3R-4
ACH580-PDR-302A-4	302	250	R9	PxB1-6	PxB12-6	PxB3R-5
ACH580-PDR-361A-4	361	300	R9	PxB1-6	PxB12-6	PxB3R-5
ACH580-PDR-414A-4	414	350	R9	PxB1-6	PxB12-6	PxB3R-5
U_i = 500 to 600 V. Power ratings are valid at nominal output voltage U_N = 575 V 60 Hz						
ACH580-PDR-02A7-6	2.7	2	R2	Px1-2	Px12-2	PxB3R-1
ACH580-PDR-03A9-6	3.9	3	R2	Px1-2	Px12-2	PxB3R-1
ACH580-PDR-06A1-6	6.1	5	R2	Px1-2	Px12-2	PxB3R-1
ACH580-PDR-09A0-6	9.0	7.5	R2	Px1-2	Px12-2	PxB3R-1
ACH580-PDR-011A-6	11	10	R2	Px1-2	Px12-2	PxB3R-1
ACH580-PDR-017A-6	17	15	R2	Px1-2	Px12-2	PxB3R-1
ACH580-PDR-022A-6	22	20	R3	Px1-3	Px12-3	PxB3R-2
ACH580-PDR-027A-6	27	25	R3	Px1-3	Px12-3	PxB3R-2
ACH580-PDR-032A-6	32	30	R3	Px1-3	Px12-3	PxB3R-2
ACH580-PDR-041A-6	41	40	R5	PxB1-3	PxB12-3	-
ACH580-PDR-052A-6	52	50	R5	PxB1-3	PxB12-3	-
ACH580-PDR-062A-6	62	60	R5	PxB1-3	PxB12-3	-
ACH580-PDR-077A-6	77	75	R5	PxB1-3	PxB12-3	-
ACH580-PDR-099A-6	99	100	R7	PxB1-3	PxB12-3	-
ACH580-PDR-125A-6	125	125	R7	PxB1-3	PxB12-3	-
ACH580-PDR-144A-6	144	150	R8	PxB1-3	PxB12-3	-

¹⁾ See notes and definitions on page 18.

²⁾ 100 HP at 230 V

Ratings, types and voltages

ACH580-31, ultra-low harmonic drives

Type Code	Nominal Output Ratings ¹⁾		Frame Size	Dim Ref UL Type 1	Dim Ref UL Type 12 +B056
	Current A	Power HP			
U₁ = 380 to 480 V. Power ratings are valid at nominal output voltage 460 V 60 Hz					
ACH580-31-07A6-4	7.6	5	R3	31-1-R3	31-12-R3
ACH580-31-012A-4	12	7.5	R3	31-1-R3	31-12-R3
ACH580-31-014A-4	14	10	R3	31-1-R3	31-12-R3
ACH580-31-023A-4	23	15	R3	31-1-R3	31-12-R3
ACH580-31-027A-4	27	20	R6	31-1-R6	31-12-R6
ACH580-31-034A-4	34	25	R6	31-1-R6	31-12-R6
ACH580-31-044A-4	44	30	R6	31-1-R6	31-12-R6
ACH580-31-052A-4	52	40	R6	31-1-R6	31-12-R6
ACH580-31-065A-4	65	50	R6	31-1-R6	31-12-R6
ACH580-31-077A-4	77	60	R6	31-1-R6	31-12-R6

¹⁾ See notes and definitions on page 18.



Option compatibility

Descriptions

Constructions												Option	Option Code	Description
01	VCR	VDR	BCR	BDR	PCR	PDR	31	3BCR	3BDR	3PCR	3PDR			
•	•	•	•	•	•	•	•	•	•	•	•	UL (NEMA) Type 1	-	Indoor use primarily to provide a degree of protection against limited amounts of falling dirt.
•			•	•	•	•	•	•	•	•	•	UL (NEMA) Type 12	+B056	Indoor use primarily to provide a degree of protection against circulating dust, falling dirt, and dripping non-corrosive liquids. Does not protect against contamination from salt-laden air
			•	•	•	•		•	•	•	•	UL (NEMA) Type 3R	+B058	Either indoor or outdoor use to provide a degree of protection against falling dirt, rain, sleet, and snow; and that will be undamaged by the external formation of ice on the enclosure.
			•	•	•	•		•	•	•	•	UL (NEMA) Type 3R Stainless Steel	+B058+C165	Either indoor or outdoor use to provide a degree of protection against falling dirt, rain, sleet, and snow; and that will be undamaged by the external formation of ice on the enclosure. Enclosure is made of Stainless Steel grade 304. Internal heating strips and cooling fans regulate the internal temperature of the enclosure.
			•	•	•	•		•	•	•	•	UL (NEMA) Type 4	+B057	Either indoor or outdoor use to provide a degree of protection against falling dirt, windblown dust, rain, sleet, snow, splashing water, and hose-directed water; and that will be undamaged by the external formation of ice on the enclosure. Enclosure is made of powder coated galvanized steel. An air conditioner is mounted on the side of the enclosure for cooling of the VFD.
			•	•	•	•		•	•	•	•	UL (NEMA) Type 4X	+B063+C165	Either indoor or outdoor use to provide a degree of protection against falling dirt, windblown dust, rain, sleet, snow, splashing water, and hose-directed water; and that will be undamaged by the external formation of ice on the enclosure. Enclosure is made of Stainless Steel grade 304. A stainless steel air conditioner made of 304 grade steel is mounted on the side of the enclosure for cooling of the VFD.
•	•	•	•	•				•	•			Service Switch	+F267	Provides a means to manually disconnect power to the drive.
			•	•	•	•						Line Reactor	+E213	A line reactor provides additional line side impedance for power conditioning. In some applications the line reactor will prevent nuisance drive trips and slightly reduce overall harmonic current.
			•	•	•	•						Passive Filter	+E211	A passive harmonic filter (inductive-capacitive) style is installed and wired in series with the drive. For power factor control, the contactor drops out the tuning reactor and capacitors during light loading. This filter is designed to limit current distortion to less than 5%.
			•	•				•	•			Softstart Bypass	+G390	The Softstarter is installed in the bypass circuit ahead of the Bypass Contactor power contacts. Softstarter operation is initiated by means of a control circuit interlock contact on the Bypass Contactor. Softstarter UP-TO-SPEED and FAULT signals (contact closures) are available at the Softstarter terminal block.
					•	•						Redundant	+C170	The redundant drive control option has two drives installed into a single enclosure to act as a backup for critical applications. The control scheme automatically switches from selected Lead Drive to secondary drive upon a fault on the selected Lead Drive. Each drive equipped with Drive Fuses and electrically interlocked drive output contactors.
			•	•	•	•						MMPs	+xG405+M6xx	Control multiple motors with a single drive. Size the drive based on the combined power rating of all of the loads that will be controlled by the drive. ABB Manual Motor Protectors (MMPs) are sized based on each individual load are installed on the output of the VFD.

Adding these options may change the dimensions of the enclosure. Contact ABB for available configuration requirements.

Dimensions

ACH580-01

ACH580-01, wall-mounted UL Type 1

Dim Ref	Height		Width		Depth		Weight	
	(in)	(mm)	(in)	(mm)	(in)	(mm)	(lb)	(kg)
01-1-R1	14.69	373	4.92	125	8.78	223	10.1	4.6
01-1-R2	18.62	473	4.92	125	9.02	229	14.6	6.6
01-1-R3	19.29	490	7.99	203	9.02	229	26.0	11.8
01-1-R4	25.04	636	7.99	203	10.12	257	41.9	19.0
01-1-R5	28.82	732	7.99	203	11.61	295	62.4	28.3
01-1-R6	28.62	727	9.92	252	14.53	369	93.5	42.4
01-1-R7	34.65	880	11.18	284	14.57	370	119.1	54.0
01-1-R8	37.99	965	11.81	300	15.47	393	152.2	69.0
01-1-R9	37.60	955	14.96	380	16.46	418	213.9	97.0

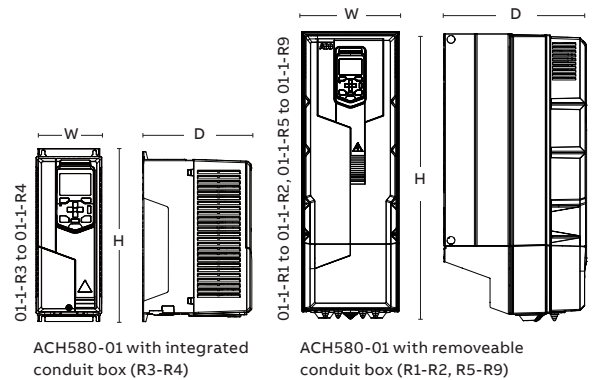

ACH580-01, wall-mounted UL Type 12 (option +B056)

Dim Ref	Height		Height (H5)		Width (W)		Width (HW)		Depth (D)		Weight	
	(in)	(mm)	(in)	(mm)	(in)	(mm)	(in)	(mm)	(in)	(mm)	(lb)	(kg)
01-12-R1	15.87	403	17.78	452	5.04	128	5.09	129	9.17	233	10.6	4.8
01-12-R2	19.80	503	21.49	546	5.04	128	5.10	130	9.41	239	15.0	6.8
01-12-R3	19.29	490	20.93	532	8.11	206	8.16	207	9.33	237	28.7	13.0
01-12-R4	25.04	636	27.03	686	7.99	203	8.59	218	10.43	265	44.1	20.0
01-12-R5	28.82	732	32.01	813	7.99	203	8.58	218	12.60	320	63.9	29.0
01-12-R6	28.62	727	34.81	884	9.92	252	11.46	291	14.96	380	94.8	43.0
01-12-R7	34.65	880	40.86	1038	11.18	284	13.00	330	15.00	381	123.5	56.0
01-12-R8	37.99	965	44.23	1123	11.81	300	13.80	351	17.80	452	169.8	77.0
01-12-R9	37.60	955	46.75	1188	14.96	380	16.95	431	18.78	477	227.1	103.0

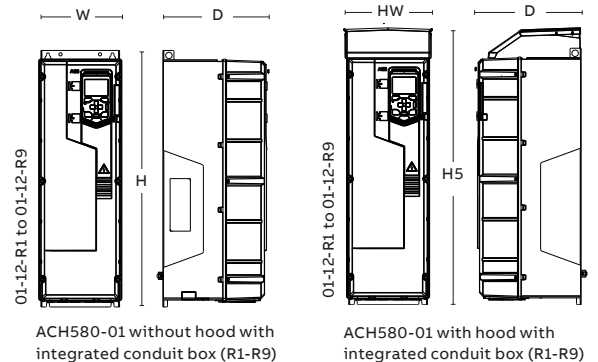

ACH580-01, mounting dimensions UL Type 1 and UL Type 12

Dim Ref	Height (H1)		Width (W1)		Width (W2)	
	(in)	(mm)	(in)	(mm)	(in)	(mm)
01-1-R1/01-12-R1	12.48	317	3.86	98	-	-
01-1-R2/01-12-R2	16.42	417	3.86	98	-	-
01-1-R3/01-12-R3	18.62	473	6.30	160	-	-
01-1-R4/01-12-R4	24.37	619	6.30	160	3.86	98
01-1-R5/01-12-R5	22.87	581	6.30	160	3.86	98
01-1-R6/01-12-R6	20.91	531	8.37	213	6.30	160
01-1-R7/01-12-R7	22.95	583	9.65	245	6.30	160
01-1-R8/01-12-R8	25.91	658	10.33	263	8.43	214
01-1-R9/01-12-R9	25.91	658	13.58	345	7.87	200

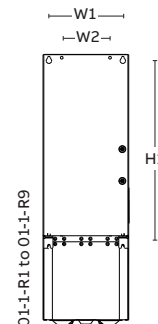

Dimensions

ACH580-VCR and ACH580-VDR

**ACH580-VCR and ACH580-VDR, vertical
E-Clipse bypass drives UL Type 1**

Dim Ref	Height		Width		Depth		Weight	
	(in)	(mm)	(in)	(mm)	(in)	(mm)	(lb)	(kg)
Vx1-1	40.18	1021	5.39	137	10.55	268	30.0	13.6
Vx1-2	44.10	1120	5.39	137	10.77	274	50.7	23.0
Vx1-3	47.70	1212	8.44	214	10.90	277	59.5	27.0
Vx1-4	56.82	1443	8.44	214	12.00	305	86.0	39.0

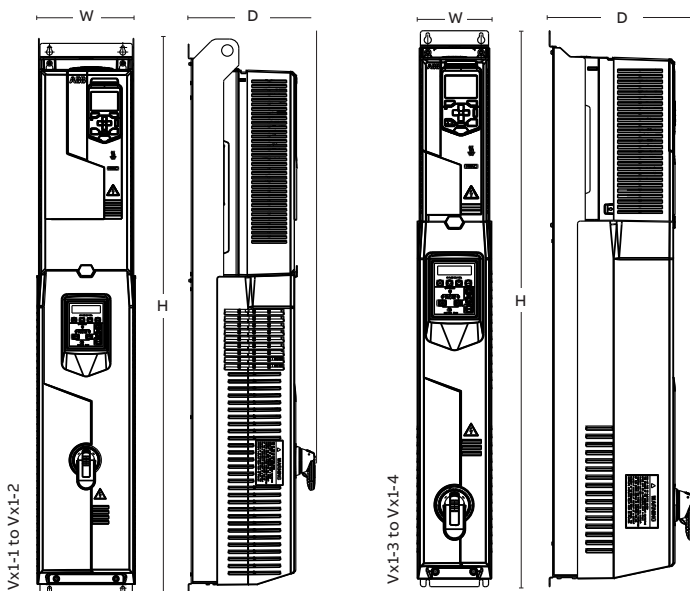

**ACH580-VCR and ACH580-VDR, vertical
E-Clipse bypass drives UL Type 1, mounting dimensions**

Dim Ref	Height (H1)		Width (W1)		Width (W2)	
	(in)	(mm)	(in)	(mm)	(in)	(mm)
Vx1-1	39.51	1004	4.93	125	3.86	98
Vx1-2	43.43	1103	4.93	125	3.86	98
Vx1-3	46.47	1180	8.19	208	6.30	160
Vx1-4	55.70	1415	8.19	208	6.30	160

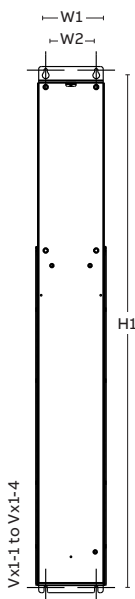

Dimensions

ACH580-BCR and ACH580-BDR

ACH580-BCR and ACH580-BDR, E-Clipse bypass drives UL Type 1

Frames	Height		Width		Depth		Weight	
	(in)	(mm)	(in)	(mm)	(in)	(mm)	(lb)	(kg)
Bx1-1	33.16	842	17.63	447	13.90	353	84.0	38.1
Bx1-2	40.60	1030	20.70	526	15.30	388	139.0	63.0
Bx1-3	47.72	1212	28.24	717	19.04	484	448.0	203.0

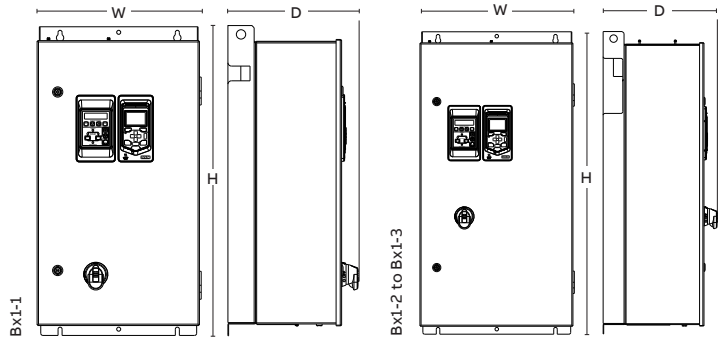
ACH580-BCR and ACH580-BDR, E-Clipse bypass drives UL Type 12

Frames	Height		Width		Depth		Weight	
	(in)	(mm)	(in)	(mm)	(in)	(mm)	(lb)	(kg)
Bx12-1	33.16	842	17.63	448	13.90	353	84.0	38.1
Bx12-2	40.60	1030	20.70	526	15.30	388	139.0	63.0
Bx12-3	54.18	1376	28.24	717	19.04	484	448.0	203.0

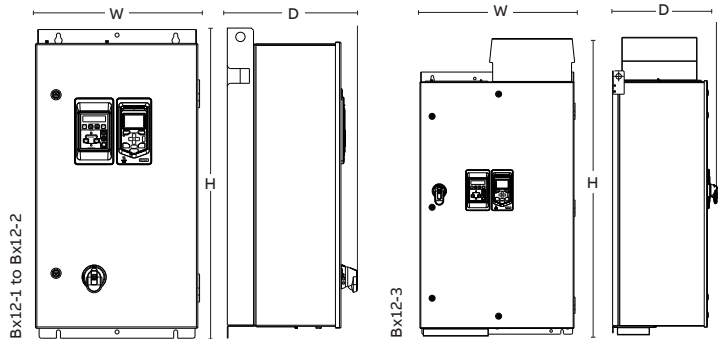

ACH580-BCR and ACH580-BDR, E-Clipse bypass drives UL Type 3R

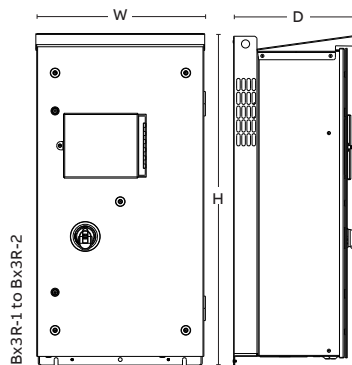
Frames	Height		Width		Depth		Weight	
	(in)	(mm)	(in)	(mm)	(in)	(mm)	(lb)	(kg)
Bx3R-1	33.40	847	17.70	449	14.00	355	83.8	38.0
Bx3R-2	40.71	1034	20.71	526	15.43	392	193.0	88.0

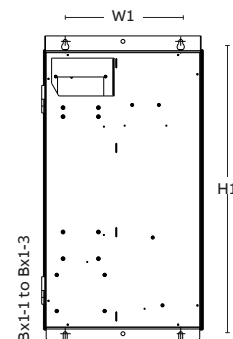

ACH580-BCR and ACH580-BDR, E-Clipse bypass drives UL Type 1, mounting dimensions

Frames	Height (H1)		Width (W1)	
	(in)	(mm)	(in)	(mm)
Bx1-1	31.89	810	12.60	320
Bx1-2	39.30	998	15.70	400
Bx1-3	46.26	1175	23.62	600



ACH580-BCR and ACH580-BDR, E-Clipse bypass drives UL Type 12, mounting dimensions

Frames	Height (H1)		Width (W1)	
	(in)	(mm)	(in)	(mm)
Bx12-1	31.89	810	12.60	320
Bx12-2	39.30	998	15.70	400
Bx12-3	46.26	1175	23.62	600

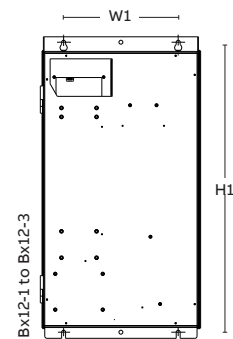

ACH580-BCR and ACH580-BDR, E-Clipse bypass drives UL Type 3R, mounting dimensions

Frames	Height (H1)		Width (W1)	
	(in)	(mm)	(in)	(mm)
Bx3R-1	31.90	810	12.60	320
Bx3R-2	39.30	998	15.70	400

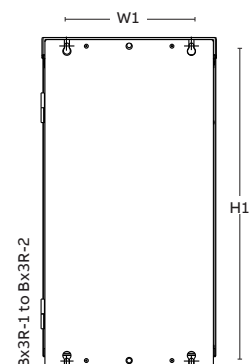

Dimensions

ACH580-PCR and ACH580-PDR

ACH580-PCR and ACH580-PDR, packaged drives with disconnect means UL Type 1

Dim Ref	Height		Width		Depth		Weight	
	(in)	(mm)	(in)	(mm)	(in)	(mm)	(lb)	(kg)
Px1-1	24.60	625	6.34	161	12.42	316	18.1	8.2
Px1-2	28.49	725	6.34	161	12.63	321	22.0	10.0
Px1-3	34.86	885	8.39	213	13.22	336	39.0	17.7
Px1-4	40.61	1032	8.39	213	14.26	362	60.0	27.2
PxB1-1	33.16	842	17.63	448	13.90	353	77.0	35.0
PxB1-2	40.60	1030	20.71	526	15.30	388	122.0	55.3
PxB1-3	47.72	1212	28.24	717	19.04	484	359.0	163.0

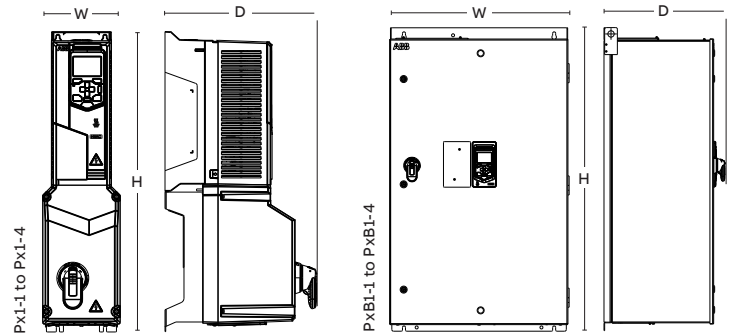

ACH580-PCR and ACH580-PDR, packaged drives with disconnect means UL Type 12

Dim Ref	Height		Width		Depth		Weight	
	(in)	(mm)	(in)	(mm)	(in)	(mm)	(lb)	(kg)
Px12-1	26.50	673	6.50	164	12.40	316	18.1	8.2
Px12-2	30.22	768	6.50	164	12.64	321	22.0	10.0
Px12-3	36.51	927	8.39	213	13.22	336	39.0	17.7
Px12-4	42.54	1081	8.39	213	14.26	362	60.0	27.2
PxB12-1	33.16	842	17.63	448	13.90	353	77.0	35.0
PxB12-2	40.60	1030	20.70	526	15.30	388	122.0	55.3
PxB12-3	48.07	1221	28.24	717	19.04	484	359.0	163.0

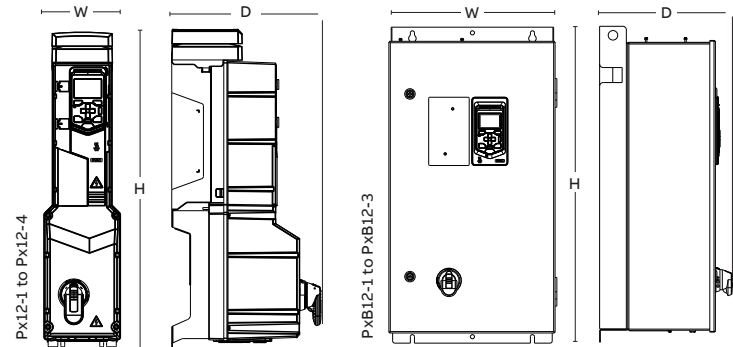

ACH580-PCR and ACH580-PDR, packaged drives with disconnect means UL Type 3R

Dim Ref	Height		Width		Depth		Weight	
	(in)	(mm)	(in)	(mm)	(in)	(mm)	(lb)	(kg)
PxB3R-1	33.35	847	17.70	449	13.98	355	77.0	35.0
PxB3R-2	40.71	1034	20.71	526	15.40	392	176.0	79.8

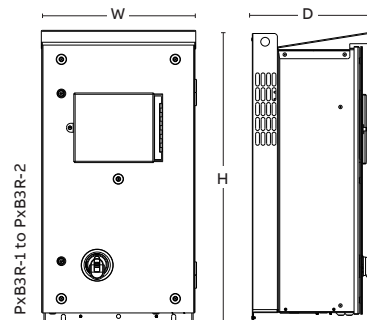

ACH580-PCR and ACH580-PDR, packaged drives with disconnect means UL Type 1, mounting dimensions

Dim Ref	Height (H1)		Width (W1)	
	(in)	(mm)	(in)	(mm)
Px1-1	12.48	317	3.86	98
Px1-2	16.42	417	3.86	98
Px1-3	18.75	476	6.30	160
Px1-4	24.49	622	6.30	160
PxB1-1	31.89	810	12.60	320
PxB1-2	39.30	998	15.70	400
PxB1-3	46.26	1175	23.62	600

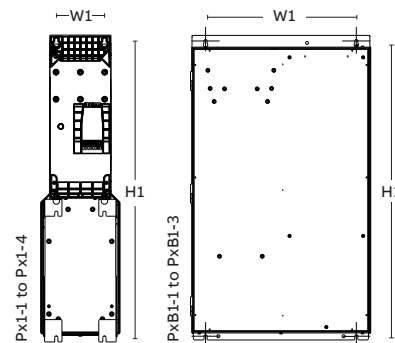

ACH580-PCR and ACH580-PDR, packaged drives with disconnect means UL Type 12, mounting dimensions

Dim Ref	Height (H1)		Width (W1)	
	(in)	(mm)	(in)	(mm)
Px12-1	12.48	317	3.86	98
Px12-2	16.42	417	3.86	98
Px12-3	18.75	476	6.30	160
Px12-4	24.49	622	6.30	160
PxB12-1	31.89	810	12.60	320
PxB12-2	39.30	998	15.70	400
PxB12-3	46.26	1175	23.62	600

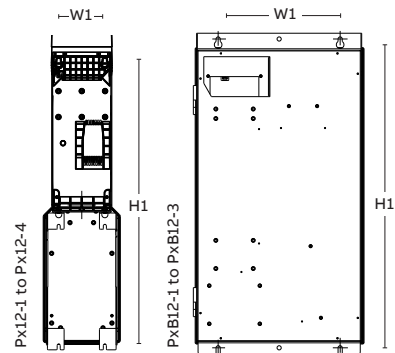

ACH580-PCR and ACH580-PDR, packaged drives with disconnect means UL Type 3R, mounting dimensions

Dim Ref	Height (H1)		Width (W1)	
	(in)	(mm)	(in)	(mm)
PxB3R-1	31.90	810	12.60	320
PxB3R-2	39.30	998	15.70	400

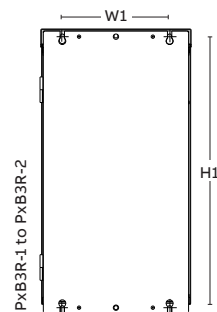

Standard configuration dimensions for reference only.

Dimensions

ACH580-31

ACH580-31, ultra-low harmonic drive, UL Type 1

Dim Ref	Height		Width		Depth		Weight	
	(in)	(mm)	(in)	(mm)	(in)	(mm)	(lb)	(kg)
31-1-R3	19.49	495	8.07	205	13.74	349	46.97	21.3
31-1-R6	30.35	771	9.92	252	15.44	392	134.51	61.0

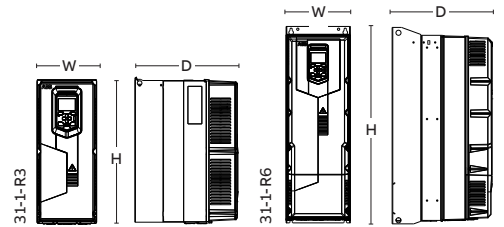

ACH580-31, ultra-low harmonic drive, UL Type 12

Dim Ref	Height		Height (H5)		Width (W)		Width (HW)		Depth		Weight	
	(in)	(mm)	(in)	(mm)	(in)	(mm)	(in)	(mm)	(in)	(mm)	(lb)	(kg)
31-12-R3	19.49	495	-	-	8.07	205	-	-	14.17	360	51.38	23.3
31-12-R6	30.35	771	36.56	929	9.92	252	11.46	291	17.65	448	138.92	63.0

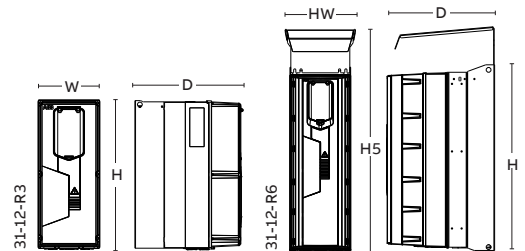

ACH580-31, ultra-low harmonic drive, mounting dimensions UL Type 1 and UL Type 12

Dim Ref	Height (H1)		Width (W1)		Width (W2)	
	(in)	(mm)	(in)	(mm)	(in)	(mm)
31-1-R3/31-12-R3	18.66	474	6.30	160	-	-
31-1-R6/31-12-R6	29.65	753	8.37	212.5	6.30	160

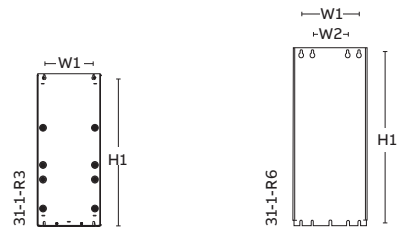

Comprehensive connectivity

Default control connections

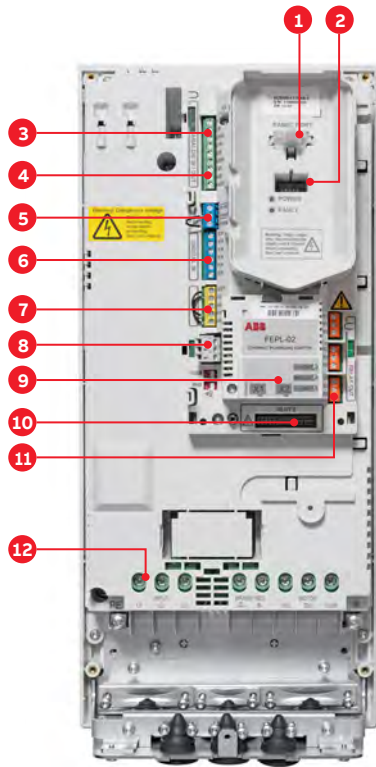

- 1. Panel port (PC tools, control panel)
- 2. ABB drive customizer port for programming the drive without mains
- 3. Analog inputs (2 × AI)
- 4. Analog outputs (2 × AO)
- 5. 24 V DC output
- 6. Digital inputs (6 × DI)
- 7. Safe torque off (STO)
- 8. Embedded fieldbus
- 9. Communication options (fieldbuses)
- 10. Analog and digital I/O extensions
- 11. Relay outputs (3 × RO)
- 12. Mains connection

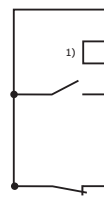
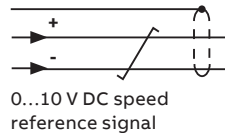

Damper actuator
Run status
Fault status

Terminal	Meaning	Default macro connections	
X1 Reference voltage and analog inputs and outputs			
1	SCR	Signal cable shield (screen)	
2	AI1	Output frequency/speed reference: 0 to 10 V	
3	AGND	Analog input circuit common	
4	+10 V	Reference voltage 10 V DC	
5	AI2	Actual feedback: 0 to 20 mA	
6	AGND	Analog input circuit common	
7	AO1	Output frequency: 0 to 10 V	
8	AO2	Motor current: 0 to 20 mA	
9	AGND	Analog output circuit common	
X2 & X3 Aux. voltage output and programmable digital inputs			
10	+24 V	Aux. voltage output +24 V DC, max. 250 mA	
11	DGND	Aux. voltage output common	
12	DCOM	Digital input common for all	
13	DI1	Stop (0)/Start (1)	
14	DI2	Not configured	
15	DI3	Constant frequency/speed selection	
16	DI4	Start interlock 1 (1 = allow start)	
17	DI5	Not configured	
18	DI6	Not configured	
X6, X7, X8 Relay outputs			
19	RO1C	Damper control 250 V AC/30 V DC 2 A	Energize damper 19 connected to 21
20	RO1A		
21	RO1B		
22	RO2C	Running 250 V AC/30 V DC 2 A	Running 22 connected to 24
23	RO2A		
24	RO2B	Fault (-1) 250 V AC/30 V DC 2 A	Fault condition 25 connected to 26
25	RO3C		
26	RO3A		
27	RO3B		
X5 Embedded fieldbus			
29	B+	Embedded fieldbus, EFB (EIA-485)	
30	A-		
31	DGND		
S4	TERM	Termination switch	
S5	BIAS	Bias resistors switch	
X4 Safe torque off			
34	OUT1	Safe torque off. Factory connection. Both circuits must be closed for the drive to start. See chapter <i>The Safe torque off function</i> in the <i>hardware manual</i> of the drive.	
35	OUT2		
36	SGND		
37	IN1		
38	IN2		
X10 24 V AC/DC			
40	24 V AC/DC+ in	R6-R11 only: Ext. 24V AC/DC input to power up the control unit when the main supply is disconnected.	
41	24 V AC/DC- in		

Notes:

¹⁾ Connected with jumpers at the factory.

²⁾ Only frames R6-R11 have terminals 40 and 41 for external 24 V AC/DC input.

Options

Controlling your drive remotely eliminates the need to be at the drive to make adjustments. Accurate remote diagnostics are possible through the building management system (BMS), which enables real-time monitoring. Total building system costs are reduced thanks to the reduced wiring and number of building automation I/O points, and the ability to use passthrough I/O.

I/O options

Option code	Description	Type designation
+L501*	External 24 V DC/AC and digital I/O extension (2xRO and 1xDO)	CMOD-01
+L512*	115/230V digital input (6xDI and 2xRO)	CHDI-01

* Not available as plus code on Bypass

Input/output extension modules

Standard input and output can be extended by using optional analog and digital input/output extension modules.

Fieldbus adapters

Option code	Drive/Bypass	Fieldbus protocol	Adapter
+K465	Available/Coming 2019	BACnet/IP (2-port)	FBIP-21-KIT
+K451	Available	DeviceNet	FDNA-01-KIT
+K454	Available	PROFIBUS-DP	FPBA-01-KIT
+K475	Available	Ethernet/IP, PROFINET IO, Modbus TCP (2-port)	FENA-21-KIT
+K452	Coming 2019	LonWorks	FLON-01-KIT

BACnet/IP option

Native BACnet/IP allows for greater bandwidth for more frequent polling/monitoring and more devices on the same sub-network. Thanks to the two-port design of this adapter, the need for external switches is reduced and installation time is shortened. Different buildings may have different fieldbuses, and we have multiple option modules to satisfy your needs.

Control panel options

The HVAC control panel (ACH-AP-H) is included as standard in the delivery unless otherwise specified.

Option code	Description	Type designation
STD	HVAC control panel (standard)	ACH-AP-H
+J429	HVAC control panel with Bluetooth interface	ACH-AP-W
*	HVAC branded control panel mounting platform (flush-mounted, includes panel bus adapter)	DPMP-06-EXT-H

* Enter as as separate line item, not part of configuration code

Wireless connectivity

With the Bluetooth-enabled assistant control panel, you can commission, start, stop, and monitor the drive, and reset faults from different devices such as tablets.

High protection for operation in harsh environments

Thanks to the drive's wall-mountable construction in both UL (NEMA) Type 1 and UL (NEMA) Type 12 configurations the ACH580-01 can be installed in clean rooms, and provides protection against circulating dust, falling dirt, and dripping non-corrosive liquids.

The robust, protective design ensures that no additional enclosures or components, such as dust filters and fans, are needed. Overall, drives for harsh environments require smaller capital expenses by avoiding or advancing maintenance of external components, which in turn improves the reliability of the drive and the process.



Flange mounting

The ACH580-01 wall-mounted drive offers flange mounting as an option, separating the control electronics from the main circuit cooling airflow, saving space and ensuring optimal cooling. This results in better thermal management during panel installation and reduces the overall enclosure size. Furthermore, the need for air-conditioning can often be eliminated, as up to 80 percent of the heat load is removed through the back of the panel.

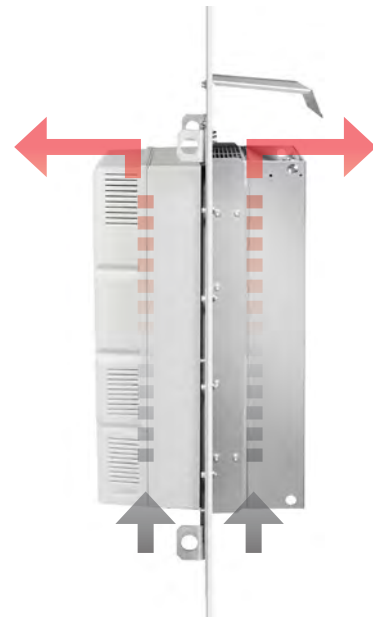

ACH580

Motor control options



Super-E motor



ABB IE4 synchronous reluctance motor SynRM



Induction motors, the industry workhorse

Pair the ACH580 with an induction motor for simple and reliable operation. Further simplifying setup, the ACH580 drive is factory-delivered with EM series nameplate motor data.



Permanent Magnet motors for smooth operation

ABB has the software, hardware and application knowledge to support Permanent Magnet motor technology. Permanent Magnet technology offers users efficiency across the speed range, compact housing for applications such as fan walls, and eliminates the need for mechanical speed reduction equipment.



IE4 SynRM for optimized energy efficiency

A key to increased energy efficiency is the rotor design of our drive and motor package. Combining the ACH580's control technology with a synchronous reluctance motor (SynRM) will also reduce motor temperature and noise.

ABB Ability™ smartphone apps

Better connectivity and user experience with Drivetune

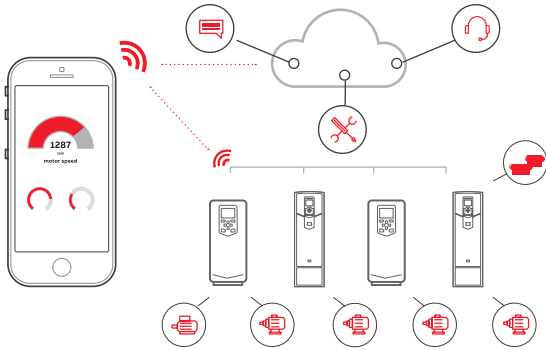

Easy and fast access to product information and support

Manage your drives and the process lines and machines they control



Easy access to cloud-based drive and process information from anywhere via an online connection



Start up, commission and tune your drive and application



Simplified user guidance with instant access to drive status and configuration



Performance optimization via drive troubleshooting features and fast support

Services and support on the go with Drivebase

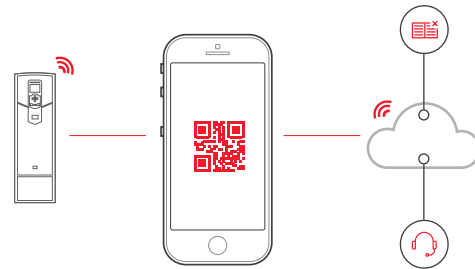

Search for support documents and contact information

Maintain and service all your installed drives at one site or multiple sites



Register your drive with the Drivebase app



Access your product and service information in the cloud from anywhere



Access your drive's diagnostics data



Push notifications for critical product and service updates

Access information anywhere

Download the apps using the QR codes below or directly from the app stores



Drivetune for commissioning and managing drives



Drivebase for ensured reliability and reduced downtime on production sites

Services to match your needs

Your service needs depend on your operations, the life cycle of your equipment, and your business priorities. We have identified our customers' four most common needs, and we created service options to satisfy them. Which will you choose to keep your drives at peak performance?

Is uptime your priority?

Keep your drives running with precisely planned and executed maintenance.

Example services include:

- ABB Ability™ Life Cycle Assessment
- Installation and Commissioning
- Spare Parts
- Preventive Maintenance
- Reconditioning
- ABB Drive Care agreement
- Drive Exchange



Operational efficiency

Is rapid response a key consideration?

If your drives need immediate action, our global network is at your service.

Example services include:

- Technical Support
- On-site Repair
- ABB Ability™ Remote Assistance
- Response time agreements
- Training



Rapid response

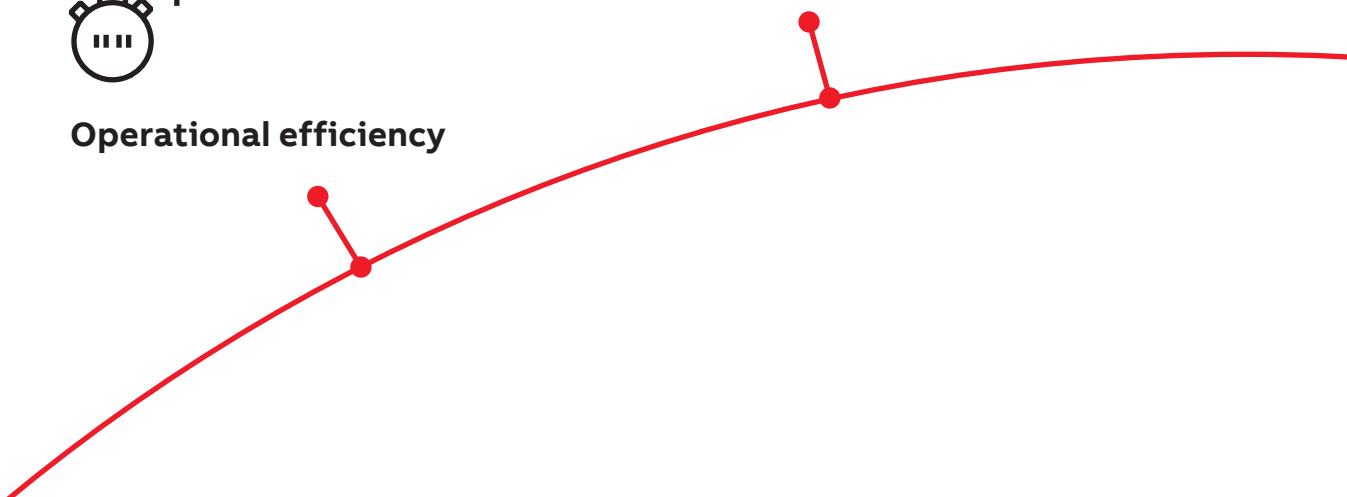

Drives service

Your choice, your future

The longevity of your drives is influenced by the service you choose.

Whatever you choose, it should be a well-informed decision. We have the expertise and experience to help you find and implement the right service for your drive equipment. Start by asking yourself these two critical questions:

- Why would my drive be serviced?
- What would my optimal service options be?

From here, count on our guidance and full support throughout the entire lifetime of your drives.

Your choice, your business efficiency

ABB Drive Care lets you focus on your core business. A selection of predefined service options matching your needs provides optimal, more reliable performance, extends your drive's lifetime, and controls costs. This reduces the risk of unplanned downtime and makes it easier to budget for maintenance.

Need to extend your assets' lifetime?

Maximize the lifetime of your drive with our services.

Example services include:

- ABB Ability™ Life Cycle Assessment
- Upgrades, Retrofits and Modernization
- Replacement, Disposal and Recycling



Life cycle management

Is performance most critical to your operation?

Get optimal performance out of your machinery and systems.

Example services include:

- ABB Ability™ Remote Services
- Engineering and Consulting
- Inspection and Diagnostics
- Upgrades, Retrofits and Modernization
- Workshop Repair
- Tailored services

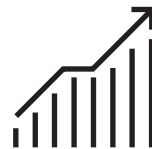

Performance improvement

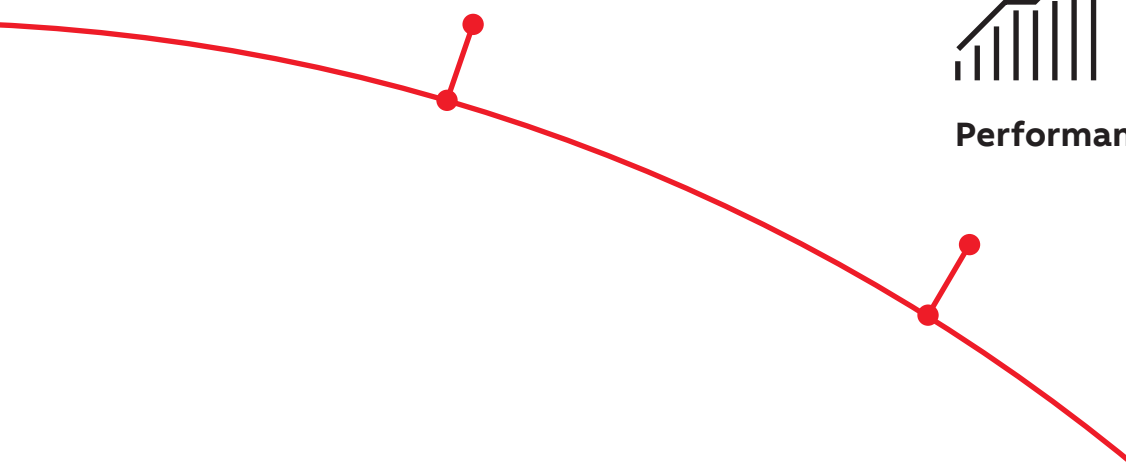

A lifetime of peak performance

You're in control of every phase of the life of your drive. At the heart of drive services is a four-phase product life cycle management model. This model defines the services recommended and available throughout your drive's lifespan.

Now it's easy for you to see the exact service and maintenance available for your drives.

ABB drives life cycle phases explained:



Full range of life cycle services and support

Limited range of life cycle services and support

Replacement and end-of-life services

Product	Product is in active sales and manufacturing phase.	Serial production has ceased. Product may be available for plant extensions, as a spare part or for installed base renewal.	Product is no longer available.	Product is no longer available.
	Services	Full range of life cycle services is available. Product enhancements may be available through upgrade and retrofit solutions.	Limited range of life cycle services is available. Spare parts availability is limited to available stock.	Replacement and end-of-life services are available.

Keeping you informed

We notify you every step of the way using life cycle status statements and announcements.

The benefit for you is clear information about the status of your drives and the exact services available. It helps you plan the preferred service actions ahead of time and make sure that continuous support is always available.

Step 1

Life Cycle Status Announcement

Provides early information about the upcoming life cycle phase change and how it affects the availability of services.

Step 2

Life Cycle Status Statement

Provides information about the drive's current life cycle status, the availability of product and services, the life cycle plan, and recommended actions.

