

Note! This guide does not provide detailed installation, safety or operation instructions. See the ACS550 User's Manual for complete information.

Prepare for Installation



Warning! The ACS550 should ONLY be installed by a qualified electrician.

Unpack the Drive

Note! Lift ACS550 by its chassis and not by its cover.

1. Unpack the drive.
2. Check for any damage.
3. Check the contents against the order / shipping label.

Check

- **Motor compatibility** - Motor type, nominal current, frequency, and voltage range must match drive specifications.

- **Suitable environment** - Drive requires heated, indoor controlled environment that is suitable for the selected enclosure.

- **Wiring** - Follow local codes for wiring, circuit protection, and EMC requirements.

Refer to User's Manual and confirm that all preparations are complete.

Tools Required

Screwdrivers, wire stripper, tape measure, mounting screws or bolts, and drill.

Collect Motor Data

Collect the following motor data from the motor nameplate for later use in the ACS550 startup:

- Voltage _____
- Nominal motor current _____
- Nominal frequency _____
- Nominal speed _____
- Nominal power _____

Drive Identification

ACS550-U1-08A8-4		
U1	3~380...480V	
I2N / I2hd	8.8/6.9 A	
PN/Phd	5/3 Hp	
S/N *2030700001*		

3AUA000005429 REV C
Effective: 10/01/2007
Supersedes: 05/24/2004

Use the following chart to interpret the type code found on the drive label.

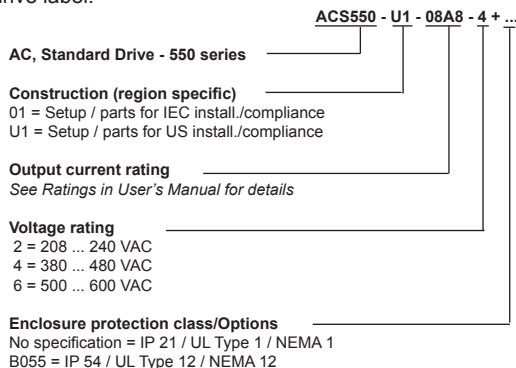

Prepare the Mounting Location

The drive requires a smooth, vertical, solid surface, free from heat and moisture, with free space for air flow - 200 mm (8 in) above and below, and 25 mm (1 in) around the sides of the drive.

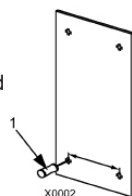

1. Mark the mounting points.
2. Drill the mounting holes.

Remove the Front Cover

1. If hood is present, remove the screws (2) holding the hood in place.
2. If hood is present, slide hood up and off of the cover.
3. Loosen the captive screws around the edge of the corner.
4. Pull near the top to remove the cover.

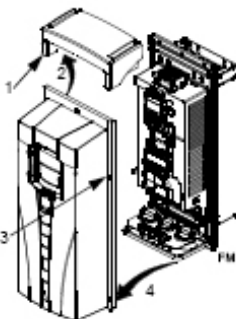

Mount the Drive

The holes providing access to the drive mounting slots require rubber plugs.

Note! Lift the ACS550 by its metal chassis.

1. As required for access, remove the rubber plugs. Push plugs out from the back of the drive.
2. R5 & R6: Align the sheet metal hood (not shown) in front of the drive's top mounting holes. (Attach as part of next step).
3. Position the ACS550 and securely tighten in all four corners.
4. Reinstall the rubber plugs.

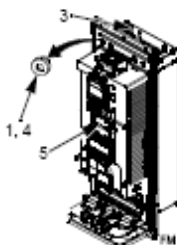

Drive^{IT} Low Voltage AC Drives

Quick Start Guide

ACS550-U1 Drives (1 to 200 Hp) UL Type 12 / NEMA 12 / IP54



Overview

The installation of the ACS550 adjustable speed AC drive follows the outline below.

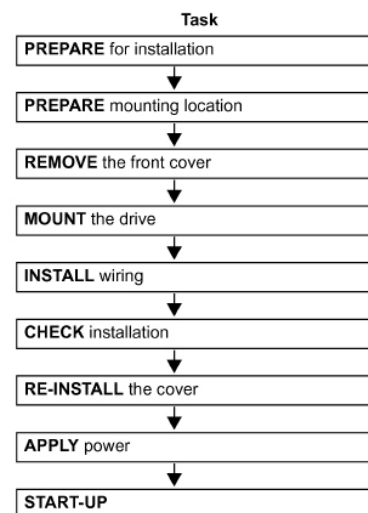

Application

This guide provides a quick reference for installations involving ACS550-U1 drives, wiring conduit, and IP 54 / NEMA 12 / UL Type 12 enclosures.

5. Non-English speaking locations: Attach a warning sticker in the appropriate language over the existing warning on the top of the module.

Install the Wiring

Note! Use separate conduit runs for input power, motor and control wiring.

General wiring

1. Cut the rubber cable seals as needed for the power, motor and control cables.

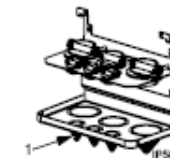

Wiring power

1. On the input power cable, strip the sheathing back far enough to route individual wires.
2. On the motor cable, strip the sheathing back far enough to expose the copper wire screen so that the screen can be twisted into a pig-tail. Keep the pig-tail short to minimize noise radiation. - 360° grounding under the clamp is recommended for the motor cable to minimize noise radiation. In this case, remove the sheathing at the cable clamp.
3. Route both cables through the clamps and tighten the clamps.
4. Connect the pig-tail created from the motor cable screen to the GND terminal.
5. Strip and connect the power/motor wires, and the power ground wire to the drive terminals. See Power connections below or, for more detail, see User's Manual.

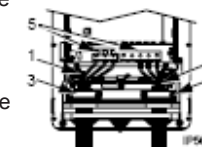

Power connections



WARNING! For IT systems and corner grounded TN systems, disconnect the internal EMC filter by removing screws: EM1 and EM3 (frame sizes R1-R4), or F1 and F2 (frame sizes R5-R6).

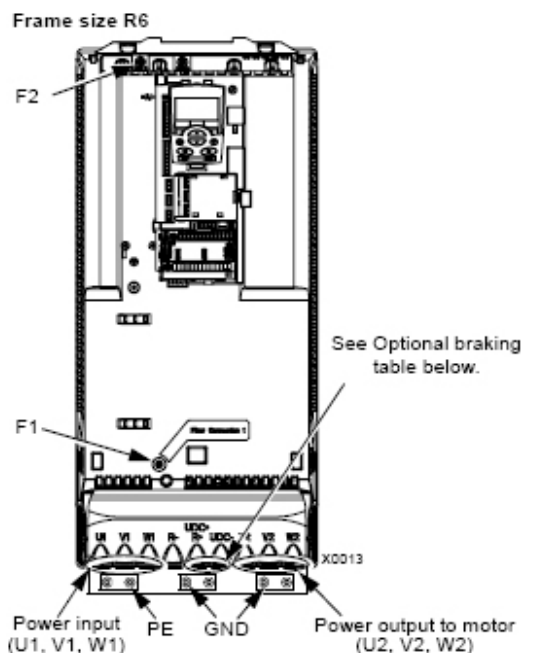
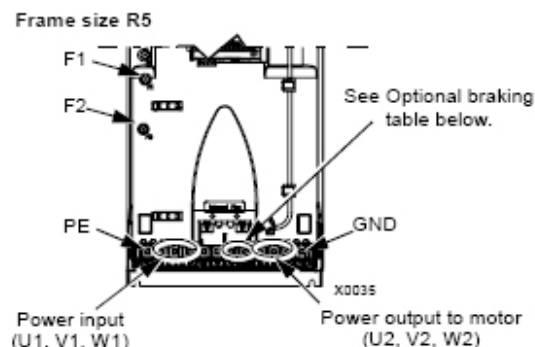
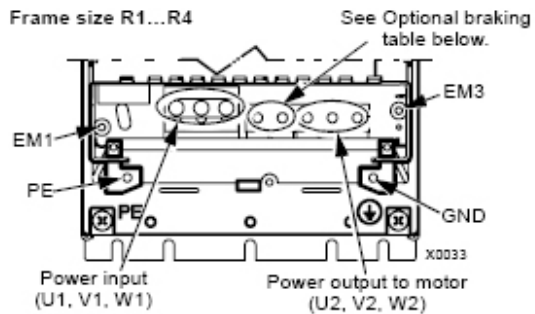

Optional braking

Frame size	Terminal labels	Brake options
R1, R2	BRK+, BRK-	Brake resistor
R3...R6	UDC+, UDC-	<ul style="list-style-type: none"> Braking unit Chopper and resistor

Wiring the controls

- Strip control cable sheathing and twist the copper screen into a pig-tail.
- Route control cable(s) through clamp(s) and tighten clamp(s).
- Connect the ground screen pig-tail for digital and analog I/O cables at X1-1. (Ground only at the drive end).
- Connect the ground screen pig-tail for RS485 cables at X1-28 or X1-32. (Ground only at the drive end).
- Strip the individual control wires and connect to the drive terminals. See Control connections below or, for more detail, see User's Manual.



ABB Standard Macro

X1	Terminal	Description
1	SCR	Signal cable shield (screen)
2	AI1	Ext. freq. ref. 1: 0...10 V
3	AGND	Analog input com.
4	10V	Ref. voltage 10 V DC
5	AI2	Not used
6	AGND	Analog input com.
7	AO1	Output freq.: 0...20 mA
8	AO2	Output current: 0...20 mA
9	AGND	Analog output com.
10	24V	Aux. volt. output +24 V DC
11	GND	Aux. volt. common
12	DCOM	Digital input com. for all
13	DI1	Start/Stop: Active = start
14	DI2	Fwd/Rev: Active = rev. dir.
15	DI3	Constant speed sel. ²
16	DI4	Constant speed sel. ²
17	DI5	Ramp pair: Active = 2 nd ramp pair
18	DI6	Not used
19	RO1C	Relay output 1
20	RO1A	Default operation: Ready = 19/21 connected
21	RO1B	
22	RO2C	Relay output 2
23	RO2A	Default operation: Running = 22/24 connected
24	RO2B	
25	RO3C	Relay output 3
26	RO3A	Default operation: Fault(-1) = 25/27 connected (Fault => 25/26 connected)
27	RO3B	

Note 1. Jumper setting (two switch types possible):

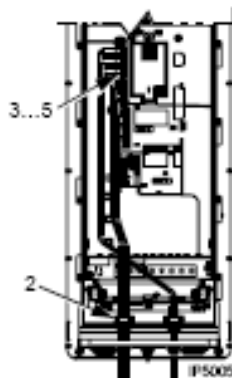

Note 2. Code: 0 = open, 1 = connected

DI3	DI4	Output
0	0	Reference through AI1
1	0	CONSTANT SPEED 1 (1202)
0	1	CONSTANT SPEED 2 (1203)
1	1	CONSTANT SPEED 3 (1204)



WARNING! The maximum voltage for digital inputs is 30 V.

Check installation

Before applying power, perform the following checks.

✓	Check
	Environment conforms to specifications.
	The drive is mounted securely.
	Proper cooling space around the drive.
	Motor and driven equipment are ready for start.
	For IT systems and corner grounded TN systems: The internal EMC filter is disconnected (screws EM1 & EM3 or F1 & F2 removed).
	Drive is properly grounded.
	Input power (mains) voltage matches the drive nominal input voltage.
	The input power (mains) terminals, U1, V1, W1, are connected and tightened as specified.
	The input power (mains) fuses are installed.
	The motor terminals, U2, V2, W2, are connected and tightened as specified.
	Motor cable is routed away from other cables.
	NO power factor compensation capacitors are in the motor cable.
	Control terminals are wired and tightened as specified.
	NO tools or foreign objects (such as drill shavings) are inside the drive.
	NO alternate power source for the motor is connected – no input voltage is applied to the output of the drive.

Reinstall the cover

- Align the cover and slide it on.
- Tighten the captive screws around the edge of the cover.
- Slide the hood down over the top of the cover (UL type 12 only).
- Install the two screws that attach the hood (UL type 12 only).
- Install the control panel.

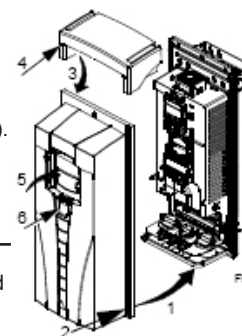

Note! The control panel window must be closed to comply with IP54 / UL Type 12 / NEMA 12.

- Optional: Add a lock (not supplied) to secure the control panel window.

Apply power

Always reinstall the front cover before turning power on.



WARNING! The ACS550 will start up automatically at power up, if the external run command is on.

- Apply input power. When power is applied to the ACS550, the green LED comes on.

Note! Before increasing motor speed, check that the motor is running in the desired direction.

Start-up

In start-up, enter motor data (collected earlier) and, if needed, edit parameters that define how the drive operates and communicates.

Assistant Control Panel

The Start-up Assistant steps through typical start-up selections, and runs automatically upon the initial power up. At other times, use the steps below to run the Start-up Assistant.

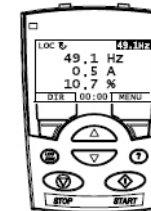

- Use the MENU key to access the Main menu.
- Select ASSISTANTS.
- Select Start-up Assistant.
- Follow the screen instructions to configure the system.

Note! For common parameters and menu items, use the Help key (?) to display descriptions.

If you encounter alarms or faults, use the Help key or refer to chapter Diagnostics in User's Manual.

Basic Control Panel

The Basic Control Panel does not include the Start-up Assistant. Refer to section "How to start up the drive" in the User's Manual and manually enter any parameter changes desired.