



Low voltage AC drives

ABB HVAC Pump and Fan AC Drives ACS320 1.2 to 50.8 A Catalog

Power and productivity
for a better world™



Selecting and ordering your drive

Build up your own ordering code using the type designation key below or contact your local ABB drives HVAC sales office and let them know what you want. Use page 3 as a reference section for more information.

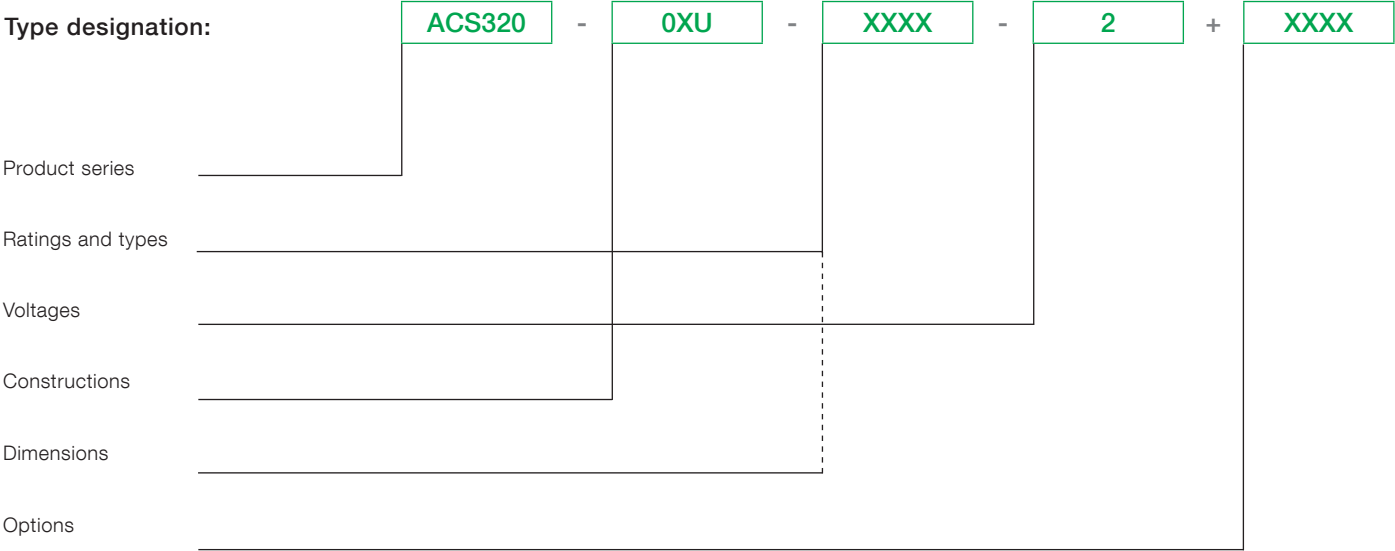

Contents

ABB HVAC pump and fan AC drive, ACS320

Introduction to ACS320, AC drives for pump and fan applications	4
Typical applications	5
Main features	6
Features, advantages and benefits	
Ratings and types	7
Type designation	
Voltages	
Construction	
Technical data	8
Dimensions and weights	9
Cabinet-mounted drives (IP20 UL Open)	
Wall-mounted drives (NEMA 1/UL Type 1)	
Cooling	10
Circuit protection	11
Control connections	12
Application macros	
Options	13
How to select options	13
User interfaces	14
Protection and installation	14
Serial communication	15
Extension module	15
DriveWindow Light	16
FlashDrop tool	17
Services	18

Introduction to ACS320

AC drives for pump and fan applications

ACS320

-

XXU

-

XXXX

-

2

+

XXXX

Making HVAC user friendly

The preprogrammed application macros and easy to use control panel make installation and drive setup simple. The control panel on the ACS320 uses HVAC terms and units, removing any guess work, and comes with 18 languages built-in. The unified height and depth of the drive frame sizes minimizes needed installation space.

Energy savings

With energy savings of up to 70 percent, the ACS320 can help to attain sustainability targets. The drive's energy optimizer tunes the drive's performance to help save even more energy. Built-in energy efficiency calculators monitor the energy used and saved. The savings are shown in kilowatt-hours and in local currency. Carbon dioxide (CO₂) emission reductions are also shown.

Complete HVAC functionality

The ACS320 comes standard with four embedded communication protocols, including BACnet (MS/TP) for easy integration into building management systems. Built-in real time clock and timers help you optimize energy use. The drive provides full output current at ambient temperatures of up to 50°C without derating. Built-in software for controlling common HVAC applications includes:

- 2 PID controllers
- Timers with real time clock
- Pump and fan control
- Cooling fan control
- Pump cleaning
- Underload (broken belt) detection
- Pump protection
- Sleep function
- Pipe fill (precharge)

Typical applications for the ACS320 include:

- Supply and return fans
- Condenser fans
- Exhaust fans
- Fume hood fans
- Booster pumps
- Submersible pumps



Typical applications

The ACS320 drive is specifically designed to meet the variable torque loads demanded by centrifugal fans and pumps. The result is maximum application uptime, reduced maintenance cost and higher energy savings.

A booster pump system is designed to boost supplied water pressure to a predetermined level in commercial buildings. The ACS320 drive features pump and fan control (PFC) for use where several parallel pumps are operated together and the required flow rate is variable.

PID control is available to allow the process to accurately maintain a pressure setpoint by adjusting the control outputs, thus allowing for precise control within difficult processes. A sleep & boost function detects slow rotation and runs the pump to boost pressure prior to shutdown. The pressure is continuously monitored and pumping restarts when the pressure falls below the minimum level.

Fan arrays use multiple motors that are often controlled by individual drives. The ACS320 offers flexibility in mounting with its compact footprint. Multiple drives in this arrangement provide redundancy ensuring year round comfort. With the optional UL type 1 kit installed on ACS320 drives the drive is plenum rated and suitable for use in the air stream. Built in building automation protocols that come standard with the product allow the user to easily set up and run the drive using BACnet, FLN, N2 or Modbus RTU reducing commission time.

Supply and return fans need to maintain air quality in spaces throughout commercial buildings, schools and hospitals. The ACS320 provides a selection of single phase 230V, three phase 230V and three phase 480V drives rated up to 30 Hp in a compact, flexible design. Whether it is cold winter nights or hot summer days, the rugged design can handle the environmental extremes with a -10 to 50 °C (14 to 122 °F) ambient temperature rating, while keeping occupants comfortable.



Main features

ACS320 - 0XU - XXXX - 2 + XXXX

Feature	Advantage	Benefit
Embedded Fieldbus Protocols: Modbus RTU (EIA-485); Johnson Controls N2; Siemens Building Technology FLN (P1); BACnet (MS/TP)	No need for external fieldbus options. Integrated and compact design.	Saves costs of external fieldbus devices. Increases reliability.
Pump protection functions	Integrated protection and control with preprogrammed features like pump cleaning, pipefill, inlet/outlet pressure supervision and detection of under or over load for preventive maintenance. Improves process control and system reliability. Integrates system protection. Smoother processes: improved and optimized system. Longer life for pump and fan systems, reduced maintenance costs.	Reduces maintenance costs. Longer life and reliable operation of pump systems.
On/off cooling fan control	Cooling fan rotates only when the drive is running, thereby cooling only when needed.	Silent operation. Improves drive's energy efficiency.
Software controlled phase inversion	Fast and easy way to change the phase order of the motor rotation.	Time savings as there is no need to change the output cable order manually.
Short parameter menu view	Only the most needed drive parameters are shown on the drive's parameter view. Complete parameter view can be changed by setting one parameter.	Time savings as the user quickly sees the most important parameters. Fast commissioning of the drive.
Energy optimizer	Improved motor efficiency with intelligent drive control method, especially while operating on partial centrifugal loads.	Boosts energy efficiency due to lower motor currents. Reduces audible noise from the motor.
Energy efficiency counters	Several counters to illustrate saved energy (kWh), carbon-dioxide emissions (CO ₂) and cost in local currency.	Shows direct impact on energy bill and helps control operational expenditure (OPEX).
Full output current at 50 °C ambient	The drive can be operated in ambient temperatures up to 50 °C without derating the output current.	Optimized drive dimensioning for wide temperature ranges.
Load analyzer	Load analyzer saves process data, such as current and torque values, which can be used to analyze the process and dimensioning of the drive and motor.	Optimized dimensioning of the drive, motor and process.
Pump and fan control (PFC) feature to control pumps and fans in parallel	One drive controls several pumps or fans and eliminates the need for an external programmable logic controller. Reduces motor stress and increases lifetime when auxiliary motors are driven according to the needed pump/fan capacity. Interlock function enables one motor to be disengaged from the mains supply while others continue operating in parallel.	Saves cost of additional drives and external PLC. Longer life for pump or fan systems while reducing maintenance time and costs. Maintenance can be carried out safely without stopping the process.
Soft pump and fan control feature (SPFC)	Reduces unwanted pressure peaks in pumps and pipelines when an auxiliary motor is started. Reduces inrush current to the power network while connecting new auxiliary motors.	Reduces maintenance costs. Longer life for pump or fan systems. Smoother processes.
PID controllers	Varies the drive's performance according to the need of the application.	Control process - pressure, flow, temperature
Compact size and flexible mounting options	The high power-to-size ratio of the drive facilitates efficient cabinet space usage. Optimum installation layout. Flexible installation with screw or DIN rail mounting. Drive can be installed sideways or side-by-side.	Space savings.
User interfaces	Advanced control panel with clear alphanumeric dynamic menus, real time clock and 14 languages. Basic panel with numerical display.	Different control panels available according to functionality needs.
Maintenance assistant	Monitors consumed energy (kWh), running hours or motor rotation.	Assists in preventive maintenance of the drive, motor or run application.
Commissioning assistants	Easy setup of parameters for PID controllers, real-time clock and serial communication.	Time savings with reduced need to set the parameters manually. Ensures all required parameters are set.
Drive protection	Motor output and I/O protected against wiring faults. Protection against unstable supply networks. Coated boards as standard.	Latest solution to protect the drive and offer trouble free use and the highest quality.

Ratings and types

ACS320 - 0XU - XXXX - 2 + XXXX

Type designation

This is the unique type code (shown to the below) that clearly identifies your drive by power rating and frame size. Once you have selected the type code, the frame size can be used to determine the drive dimensions, shown on the next page.

Voltages

ACS320 is available in two voltage ranges:

2 = 200 to 240 V

4 = 380 to 480 V

Insert either “2” or “4”, depending on your chosen voltage, into the type designation shown above.

Construction

“0XU” within the type designation (shown above) varies depending on the drive phase and EMC filtering. Choose below the one you need.

01 = 1-phase

03 = 3-phase

U = EMC filter disconnected, 60 Hz frequency

(In case the filter is required it can easily be connected.)

Type Codes below include Blank Panel only	Ratings					Frame size
	Power	Input		Output		
	Nominal Horsepower	Nominal without Reactor	Nominal with 5% Reactor	Continuous @ 50C, 10% Overload ¹	Continuous @ 40C, 0% Overload	
1-phase supply voltage 200 - 240 V units (Confirm output ratings meet motor requirements)						
ACS320-01U-02A4-2	0.5	6.1	N/A	2.3	2.4	R0
ACS320-01U-04A7-2	1	11.4	N/A	4.5	4.7	R1
ACS320-01U-06A7-2	1.5	16.1	N/A	6.5	6.7	R1
ACS320-01U-07A5-2	2	16.8	N/A	7.2	7.5	R2
ACS320-01U-09A8-2	3	21.0	N/A	9.4	9.8	R2
3-phase supply voltage 200 - 240 V units						
ACS320-03U-02A6-2	0.5	4.7	2.6	2.4	2.6	R0
ACS320-03U-03A9-2	0.75	6.7	3.9	3.5	3.9	R0
ACS320-03U-05A2-2	1	8.4	5.2	4.7	5.2	R1
ACS320-03U-07A4-2	1.5	13.0	7.4	6.7	7.4	R1
ACS320-03U-08A3-2	2	13.2	8.3	7.5	8.3	R1
ACS320-03U-10A8-2	2+	15.7	10.8	9.8	10.8	R2
ACS320-03U-14A6-2	3	23.9	14.6	13.3	14.6	R2
ACS320-03U-19A4-2	5	27.3	19.4	17.6	19.4	R2
ACS320-03U-26A8-2	7.5	45	26.8	24.4	26.8	R3
ACS320-03U-34A1-2	10	55	34.1	31.0	34.1	R4
ACS320-03U-50A8-2	15	76	50.8	46.2	50.8	R4
3-phase supply voltage 380 - 480 V units						
ACS320-03U-01A2-4	0.5	2.2	1.2	1.1	1.2	R0
ACS320-03U-01A9-4	0.75	3.6	1.9	1.7	1.9	R0
ACS320-03U-02A4-4	1	4.1	2.4	2.2	2.4	R1
ACS320-03U-03A3-4	1.5	6.0	3.3	3.0	3.3	R1
ACS320-03U-04A1-4	2	6.9	4.1	3.7	4.1	R1
ACS320-03U-05A6-4	3	9.6	5.6	5.1	5.6	R1
ACS320-03U-07A3-4	3+	11.6	7.3	6.6	7.3	R1
ACS320-03U-08A8-4	5	13.6	8.8	8.0	8.8	R1
ACS320-03U-12A5-4	7.5	18.8	12.5	11.4	12.5	R3
ACS320-03U-15A6-4	10	22.1	15.6	14.2	15.6	R3
ACS320-03U-23A1-4	15	30.9	23.1	21.0	23.1	R3
ACS320-03U-31A0-4	20	52.0	31.0	28.2	31	R4
ACS320-03U-38A0-4	25	61.0	38.0	34.5	38	R4
ACS320-03U-44A0-4	30	67.0	44.0	40.0	44	R4

¹⁾ Overloadability for one minute every ten minutes.

Technical data

ACS320

-

0XU

-

XXXX

-

2

+

XXXX

Mains connection

Voltage and power range	1-phase, 200 to 240 V \pm 10% 2.4 to 9.8 A (I_{2N}) 3-phase, 200 to 240 V \pm 10% 2.6 to 50.8 A (I_{2N}) 3-phase, 380 to 480 V \pm 10% 1.2 to 44.0 A (I_{2N})
--------------------------------	--

Frequency	48 to 63 Hz
------------------	-------------

Motor connection

Voltage	3-phase, from 0 to U_{supply}
----------------	---------------------------------

Frequency	0 to 500 Hz
------------------	-------------

Continuous loading capability	I_{2N} maximum continuous output current at ambient temperature of +40 °C. No overloadability, derating 1% for every additional 1 °C up to 50 °C.
--------------------------------------	--

Switching frequency	I_{LD} continuous output current at max ambient temperature of +50 °C. 10% overloadability for one minute every ten minutes.
----------------------------	---

Default	4 kHz
----------------	-------

Selectable	4 to 16 kHz with 4 kHz steps
-------------------	------------------------------

Acceleration time	0.1 to 1800 s
--------------------------	---------------

Deceleration time	0.1 to 1800 s
--------------------------	---------------

Motor control method	Scalar U/f
-----------------------------	------------

Environmental limits

Ambient temperature	-10 to 50 °C (14 to 122 °F), no frost allowed
----------------------------	---

Altitude	Rated current available at 0 to 1000 m (0 to 3281 ft) reduced by 1% per 100 m (328 ft) over 1000 to 2000 m (3281 to 6562 ft)
-----------------	--

Relative humidity	Lower than 95% (without condensation)
--------------------------	---------------------------------------

Degree of protection	IP20/optional NEMA 1 enclosure
-----------------------------	--------------------------------

Enclosure colour	NCS 1502-Y, RAL 9002, PMS 420 C
-------------------------	---------------------------------

Contamination levels	IEC721-3-3
-----------------------------	------------

Transportation	No conductive dust allowed
-----------------------	----------------------------

Storage	Class 1C2 (chemical gases)
----------------	----------------------------

Operation	Class 1S2 (solid particles)
------------------	-----------------------------

Storage	Class 2C2 (chemical gases)
----------------	----------------------------

Operation	Class 2S2 (solid particles)
------------------	-----------------------------

Storage	Class 3C2 (chemical gases)
----------------	----------------------------

Operation	Class 3S2 (solid particles)
------------------	-----------------------------

Product compliance

Low Voltage Directive 2006/95/EC
Machinery Directive 2006/42/EC
EMC Directive 2004/108/EC
Quality assurance system ISO 9001
Environmental system ISO 14001
UL, cUL, CE, C-Tick and GOST R approvals
RoHS compliant

Programmable control connections

Two analog inputs	
Voltage signal	
Unipolar	0 (2) to 10 V, $R_{in} > 312 \text{ k}\Omega$
Bipolar	-10 to 10 V, $R_{in} > 312 \text{ k}\Omega$
Current signal	
Unipolar	0 (4) to 20 mA, $R_{in} = 100 \Omega$
Bipolar	-20 to 20 mA, $R_{in} = 100 \Omega$
Resolution	0.1%
Accuracy	$\pm 1\%$

One analog output	0 (4) to 20 mA, load $< 500 \Omega$
--------------------------	-------------------------------------

Auxiliary voltage	24 V DC $\pm 10\%$, max. 200 mA
--------------------------	----------------------------------

Five digital inputs	12 to 24 V DC with internal or external supply, PNP and NPN, pulse train
----------------------------	--

Input impedance	0 to 16 kHz
------------------------	-------------

Input impedance	2.4 k Ω
------------------------	----------------

One relay output

Type	NO + NC
-------------	---------

Maximum switching voltage	250 V AC/30 V DC
----------------------------------	------------------

Maximum switching current	0.5 A/30 V DC; 5 A/230 V AC
----------------------------------	-----------------------------

Maximum continuous current	2 A rms
-----------------------------------	---------

One digital output

Type	Transistor output
-------------	-------------------

Maximum switching voltage	30 V DC
----------------------------------	---------

Maximum switching current	100 mA/30 V DC, short circuit
----------------------------------	-------------------------------

Frequency	10 Hz to 16 kHz
------------------	-----------------

Resolution	1 Hz
-------------------	------

Accuracy	0.2%
-----------------	------

Serial communication

Cable	Shielded twisted pair, impedance 100 to 150 ohms
--------------	--

Termination	Daisy-chained bus, without dropout lines
--------------------	--

Isolation	Bus interface isolated from drive
------------------	-----------------------------------

Transfer rate	1.2 to 76.8 kbit/s
----------------------	--------------------

Communication type	Serial, asynchronous, half duplex
---------------------------	-----------------------------------

Protocol	Modbus RTU (EIA-485); Johnson Controls N2; SiemensBuilding Technology FLN (P1); BACnet (MS/TP)
-----------------	---

Chokes

AC input chokes	External option
------------------------	-----------------

AC input chokes	For reducing THD in partial loads and to comply with EN/IEC 61000-3-12
------------------------	--

AC output chokes	External option
-------------------------	-----------------

AC output chokes	To achieve longer motor cables
-------------------------	--------------------------------

Dimensions and weights

ACS320 - 0XU - XXXX - 2 + XXXX

Cabinet-mounted drives (IP20 UL open)

Frame size	IP20 UL open					
	H1 in	H2 in	H3 in	W in	D in	Weight lb
R0	6.65	7.95	9.41	2.76	6.34	2.6
R1	6.65	7.95	9.41	2.76	6.34	2.6
R2	6.65	7.95	9.41	4.13	6.5	3.3
R3	6.65	7.95	9.29	6.65	6.65	5.5
R4	7.13	7.95	9.61	10.24	6.65	9.7

H1 = Height without fastenings and clamping plate
 H2 = Height with fastenings but without clamping plate
 H3 = Height with fastenings and clamping plate
 H4 = Height with fastenings and NEMA 1 connection box
 H5 = Height with fastenings, NEMA 1 connection box and hood
 W = Width
 D = Depth

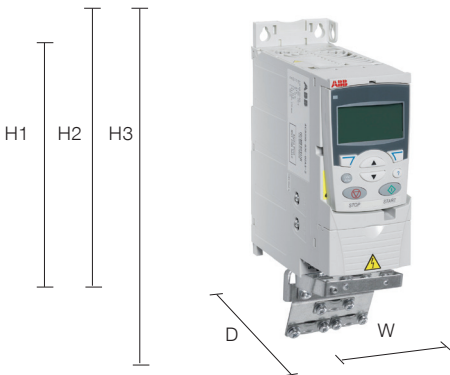

Wall-mounted drives (NEMA 1)

Frame size	NEMA 1				
	H4 in	H5 in	W in	D in	Weight lb
R0	10.12	11.02	2.76	6.65	3.5
R1	10.12	11.02	2.76	6.65	3.5
R2	10.12	11.10	4.13	6.65	4.2
R3	10.24	11.77	6.65	6.97	6.8
R4	10.63	12.60	10.24	6.97	11.0

H4 = Height with fastenings and NEMA 1 connection box
 H5 = Height with fastenings, NEMA 1 connection box and hood
 W = Width
 D = Depth

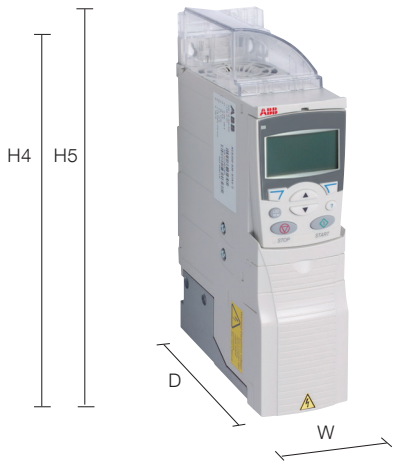

Cooling

Cooling

ACS320 is fitted with cooling fans as standard. The cooling air must be free from corrosive substances and must not be above the maximum ambient temperature of 50 °C.

For more specific limits see the Technical data - Environmental limits in this catalogue.

Cooling air flow

Type designation	Frame size	Heat dissipation		Air flow	
		[W]	BTU/hr ¹⁾	m ³ /h	ft ³ /min
1-phase AC supply, 200 to 240 V					
ACS320-01U-02A4-2	R0	42	142	-	-
ACS320-01U-04A7-2	R1	64	220	24	14
ACS320-01U-06A7-2	R1	86	295	24	14
ACS320-01U-07A5-2	R2	90	306	21	12
ACS320-01U-09A8-2	R2	111	377	21	12
3-phase AC supply, 200 to 240 V					
ACS320-03U-02A6-2	R0	42	142	-	-
ACS320-03U-03A9-2	R0	54	183	-	-
ACS320-03U-05A2-2	R1	64	220	24	14
ACS320-03U-07A4-2	R1	86	295	24	14
ACS320-03U-08A3-2	R1	88	302	21	12
ACS320-03U-10A8-2	R2	111	377	21	12
ACS320-03U-14A6-2	R2	140	476	52	31
ACS320-03U-19A4-2	R2	180	613	52	31
ACS320-03U-26A8-2	R3	285	975	71	42
ACS320-03U-34A1-2	R4	328	1119	96	57
ACS320-03U-50A8-2	R4	488	1666	96	57
3-phase supply voltage 380 - 480 V units					
ACS320-03U-01A2-4	R0	35	121	-	-
ACS320-03U-01A9-4	R0	40	138	-	-
ACS320-03U-02A4-4	R1	50	170	13	8
ACS320-03U-03A3-4	R1	60	204	13	8
ACS320-03U-04A1-4	R1	69	235	13	8
ACS320-03U-05A6-4	R1	90	306	19	11
ACS320-03U-07A3-4	R1	107	364	24	14
ACS320-03U-08A8-4	R1	127	433	24	14
ACS320-03U-12A5-4	R3	161	551	52	31
ACS320-03U-15A6-4	R3	204	697	52	31
ACS320-03U-23A1-4	R3	301	1029	71	42
ACS320-03U-31A0-4	R4	408	1393	96	57
ACS320-03U-38A0-4	R4	498	1700	96	57
ACS320-03U-44A0-4	R4	588	2007	96	57

¹⁾ BTU/hr = British Thermal Unit per hour. BTU/hr is approximately 0.293 Watts.

²⁾ Frame size R0 with free convection cooling.

Free space requirements

Enclosure type	Space above in	Space below in	Space on left/right in
All frame sizes	2.95	2.95	0

Circuit protection

Circuit protection

Standard fuses can be used with ABB general purpose drives. For input fuse connections see table below.



Selection table

Type designation	Frame size	IEC fuses		UL fuses	Manual motor protector	
		[A]	Fuse type ¹⁾	UL Class T or CC (600 V) [A]	MMP type code ^{3) 4)}	Trip current setting [A]
1-phase AC supply, 200 to 240 V						
ACS320-01U-02A4-2	R0	10	gG	10	MS132-6.3 & S1-M3-25 ⁵⁾	6.1
ACS320-01U-04A7-2	R1	16	gG	20	MS451-16E	11.4
ACS320-01U-06A7-2	R1	16/20 ²⁾	gG	25	MS451-20E	16.1
ACS320-01U-07A5-2	R2	20/25 ²⁾	gG	30	MS451-20E	16.8
ACS320-01U-09A8-2	R2	25/35 ²⁾	gG	35	MS451-25E	21.0
3-phase AC supply, 200 to 240 V						
ACS320-03U-02A6-2	R0	10	gG	10	MS132-6.3 & S1-M3-25 ⁵⁾	4.7
ACS320-03U-03A9-2	R0	10	gG	10	MS132-10 & S1-M3-25 ⁵⁾	6.7
ACS320-03U-05A2-2	R1	10	gG	15	MS132-10 & S1-M3-25 ⁵⁾	8.4
ACS320-03U-07A4-2	R1	16	gG	15	MS451-16E	13.0
ACS320-03U-08A3-2	R1	16	gG	15	MS451-16E	13.2
ACS320-03U-10A8-2	R2	16	gG	20	MS451-20E	15.7
ACS320-03U-14A6-2	R2	25	gG	30	MS451-25E	23.9
ACS320-03U-19A4-2	R2	25	gG	35	MS451-32E	27.3
ACS320-03U-26A8-2	R3	63	gG	60	MS451-50E	45.0
ACS320-03U-34A1-2	R4	80	gG	80	MS495-63E	55.0
ACS320-03U-50A8-2	R4	100	gG	100	MS495-90E	76.0
3-phase AC supply, 440 to 480 V⁶⁾						
ACS320-03U-01A3-4	R0	10	gG	10	MS132-2.5 & S1-M3-25 ⁵⁾	2.0
ACS320-03U-02A1-4	R0	10	gG	10	MS132-4.0 & S1-M3-25 ⁵⁾	3.3
ACS320-03U-02A6-4	R1	10	gG	10	MS132-6.3 & S1-M3-25 ⁵⁾	3.8
ACS320-03U-03A6-4	R1	10	gG	10	MS132-6.3 & S1-M3-25 ⁵⁾	5.5
ACS320-03U-04A5-4	R1	16	gG	15	MS132-10 & S1-M3-25 ⁵⁾	6.3
ACS320-03U-06A2-4	R1	16	gG	15	MS132-10 & S1-M3-25 ⁵⁾	8.8
ACS320-03U-08A0-4	R1	16	gG	20	MS451-16E	11.0
ACS320-03U-09A7-4	R1	20	gG	25	MS451-16E	12.0
ACS320-03U-13A8-4	R3	25	gG	30	MS451-20E	17.0
ACS320-03U-17A2-4	R3	35	gG	35	MS451-25E	20.0
ACS320-03U-25A4-4	R3	50	gG	50	MS451-32E	28.0
ACS320-03U-34A1-4	R4	80	gG	80	MS451-50E	48.0
ACS320-03U-41A8-4	R4	100	gG	100	MS495-63E	56.0
ACS320-03U-48A4-4	R4	100	gG	100	MS495-63E	61.0

Other fuse types can be used if they meet the ratings and the melting curve of the fuse does not exceed the melting curve of the fuse mentioned in this table.

¹⁾ According to IEC-60269 standard.

²⁾ If 50% overload capacity is needed, use the bigger fuse alternative.

³⁾ All manual motor protectors listed are Type E self-protected up to 65 kA.

⁴⁾ Manual motor protectors may require adjusting the trip limit from the factory setting at or above the drive input Amps to avoid nuisance tripping. If the manual motor protector is set to the maximum current trip level and nuisance tripping is occurring, then select the next size MMP. (MS132-10 is the highest size in MS132 frame size to meet Type E at 65 kA; the next size up is the MS451-16E).

⁵⁾ S1-M3-25 line side feeder terminal is needed with manual motor protector to meet Type E self protection class according to UL and cUL requirements.

⁶⁾ 480Y/277V only.

Control connections

ACS320 - 0XU - XXXX - 2 + XXXX

Application macros

Application macros are preprogrammed parameter sets. While starting up the drive, the user typically selects one of the macros that is best suited for the application. The diagram below gives an overview of ACS320 control connections and shows the default I/O connections for the HVAC default macro.

- HVAC default
- Supply fan
- Return fan
- Cooling tower fan
- Condenser
- Booster pump
- Pump alternation
- Internal timer
- Internal timer / constant speeds
- Floating point
- Dual setpoint PID
- Dual setpoint PID / constant speeds
- E-Bypass
- Hand control

In addition to the standard macros the user can create two user macros. The user macro allows the user to save the parameter settings for later use.

The diagram below gives an overview of ACS320 control connections. Please refer to the ACS320 user's manual for more detailed information.

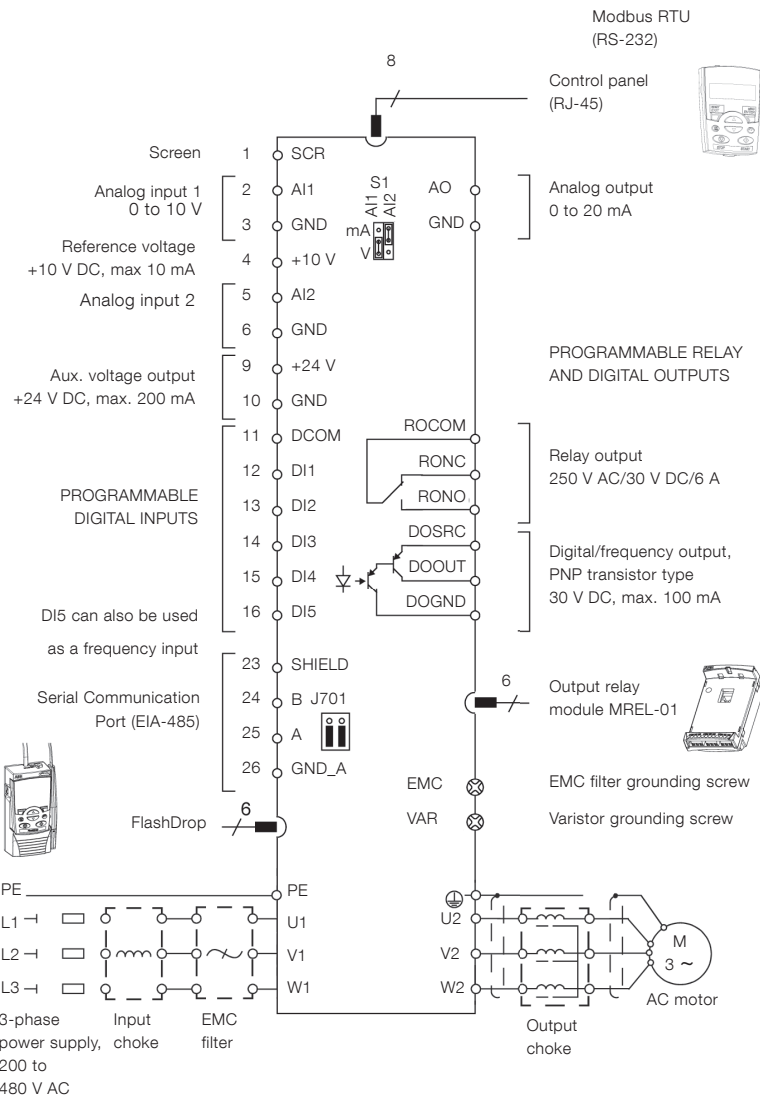

Typical I/O connections

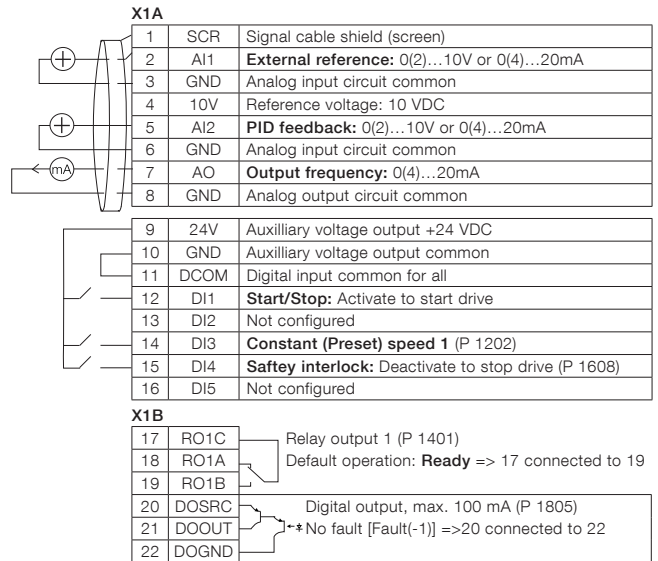

Options

ACS320 - 0XU - XXXX - 2 + XXXX

How to select options

The options shown in the table below are available within the ACS320 range. The control panels have an associated 4-figure option code, which is shown in the second column. It is this code that replaces XXXX in the type code above.

Options	Ordering code	Description	Model
Protection class	1	NEMA 1/UL type 1 (R0, R1, R2)	MUL1-R1
	2	NEMA 1/UL type 1 (R3)	MUL1-R3
	3	NEMA 1/UL type 1 (R4)	MUL1-R4
Control panel	J400	Advanced control panel	ACH-CP-B
	J404	Basic control panel	ACS-CP-C
Panel mounting kit	1	Panel mounting kit	ACS/H-CP-EXT
	2	Panel holder mounting kit	OPMP-01
Extension modules	L511	Relay output extension module.	MREL-01
Tools	1	FlashDrop tool	MFD1-01
	2	DriveWindow Light 2	DriveWindow Light 2
Remote monitoring	1	Ethernet adapter	SREA-01

¹ Ordering with a separate MRP code number. With MUL1 option, suitable for installation in a compartment handling conditioned air.

¹ The ACS320 is compatible with ACS-CP-C basic control panel Rev M or later.

² The ACS320 is compatible with ACH-CP-B assistant control panel Rev E or later.

(New panel series manufactured since 2007 with serial number XYYWWRXXXX, where year Y = 7 or greater and revision R = E, F, G, ...)

Options

User interfaces

ACS320 - 0XU - XXXX - 2 + XXXX

User interface

Panel cover

The purpose of the panel cover is to protect the drive's connection surfaces. The ACS320 drive is delivered with a panel cover as standard. In addition there are two alternative control panels available as options.

Basic control panel

The basic control panel features a single line numeric display. The panel can be used to control the drive, set parameter values or copy them from one drive to another.

Advanced control panel

The ACS320 operator control panel is designed specifically for HVAC applications. The operator panel includes HAND, OFF, AUTO, and speed INCREASE and DECREASE keys for manual operation. Other features include a HELP key, backlit display, multilingual selections, text / graphic displays and a real time clock. The large display and soft keys make it extremely easy to navigate.

Panel mounting kits

To attach the control panel to the outside of a larger enclosure, two panel mounting kits are available. A simple and cost-efficient installation is possible with the ACS/H-CP-EXT kit, while the OPMP-01 kit provides a more user-friendly solution, including a panel platform that enables the panel to be removed in the same way as a drive-mounted panel. The panel mounting kits include all hardware required, including 3 meters extension cables and installation instructions.

Protection and installation

NEMA 1 kit

The NEMA 1 kit includes a connection box for finger protection, conduit tube installation, and a hood for protection against dirt and dust.

Terminal cover

The terminal cover is for protection of the I/O connections.

Clamping plates

The clamping plates are used for protection against electrical disturbances. The clamping plates with the clamps are included in the drive package as standard.



Panel cover (included as standard)



Basic control panel



Advanced control panel



Panel holder mounting kit OPMP-01



NEMA 1 kit



Terminal cover
(included as standard)

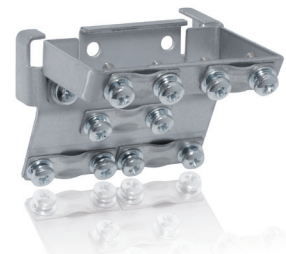

Clamping plates
(included as standard)

Options

User interfaces

ACS320 - 0XU - XXXX - 2 + XXXX

Serial communication

The embedded building automation protocols bring connectivity to major HVAC systems. A single twisted pair cable avoids large amounts of conventional cabling, thereby reducing costs and increasing system reliability.

Extension module

MREL-01

ACS320 has one relay output as standard. The optional MREL-01 module offers three additional relay outputs. The outputs can be configured for different functions by setting selected parameters.

SREA-01 Ethernet adapter

SREA-01 Ethernet adapter with remote monitoring access can send process data, data logs and event messages independently, without a PLC or a dedicated on-site computer. It has an internal web server for configuration and drive access.

In remote locations without qualified service people on-site it is vital to be able to monitor the drive remotely. Monitoring and diagnostics routines can be easily implemented with ABB's remote monitoring tool. The remote monitoring tool enables to connect multiple drives to Ethernet, to collect operational data from the process and send the collected data to a central location for process monitoring and further analysis.

Additionally, the SREA-01 Ethernet adapter offers Modbus TCP to Modbus RTU gateway functionality which enables Modbus TCP connectivity to ACS320. Please refer to SREA-01 user's guide for more detailed information.

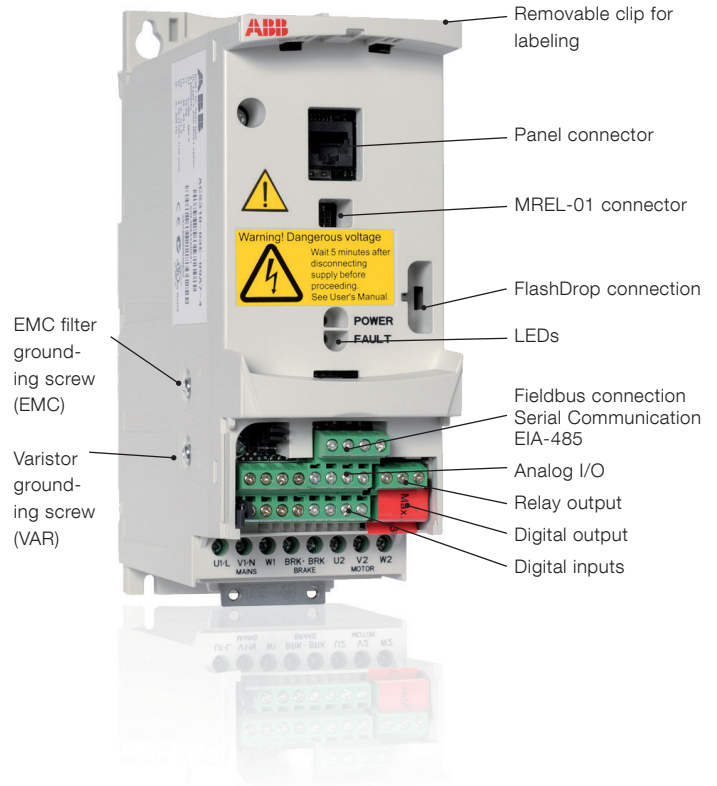

Extension module MREL-01



SREA-01 Ethernet adapter

Options

Software tools

A separate order line and type designation is required for any of these software tool options.

DriveWindow Light

DriveWindow Light is an easy-to-use startup and maintenance tool for ACS320 drives. It can be used in an offline mode, which enables parameter setting at the office even before going to the actual site. The parameter browser enables viewing, editing and saving of parameters. The parameter comparison feature makes it possible to compare parameter values between the drive and saved parameter files. With the parameter subset you can create your own parameter sets. Controlling the drive is one of the features in DriveWindow Light. With this software tool, you can monitor up to four signals simultaneously. This can be done in both graphical and numerical format. DriveWindow Light version 2.9 or later is compatible with ACS320 drives.

Startup wizards

Startup wizards make the setting of parameters easy. Simply launch the wizard, select an appropriate assistant eg, for setting analog outputs, and all parameters related to this function are shown together with help pictures.

Highlights

- Editing, saving and downloading parameters
- Graphical and numerical signal monitoring
- Drive control
- Startup wizards

DriveWindow Light requirements

- Windows NT/2000/XP/Vista/Windows 7
- Serial port from a PC
- Control panel connector

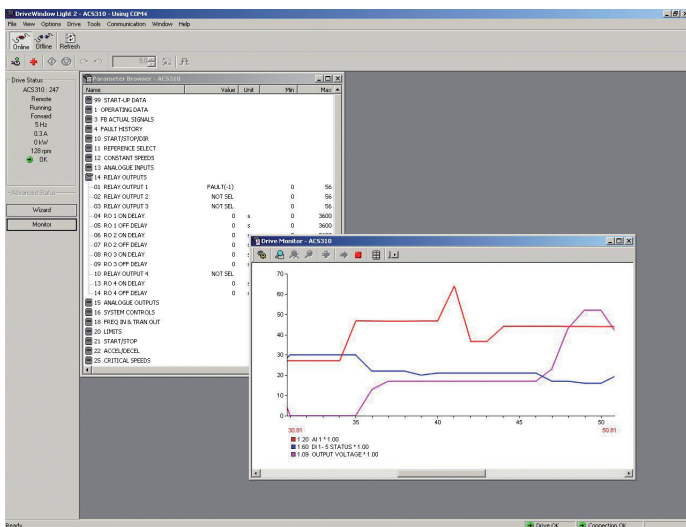

Options External

A separate order line and type designation is required for any of these external options.

FlashDrop tool

FlashDrop is a powerful palm sized tool for fast and easy parameter selecting and setting. It gives the possibility to hide selected parameters to protect the machine. Only the parameters needed in the application are shown. The tool can copy parameters between two drives or between a PC and a drive. All the above can be done without a power connection to the drive – in fact, it is not even necessary to unpack the drive.

DrivePM

DrivePM (Drive parameter manager) is a tool to create, edit and copy parameter sets for FlashDrop. For each parameter/group the user has a possibility to hide it, which means that the drive user does not see the parameter/group at all. DrivePM version 1.2 is compatible with ACS320 drives.

DrivePM requirements

- Windows 2000/XP/Vista/Windows 7
- Serial port from a PC

FlashDrop package includes

- FlashDrop tool
- DrivePM software on a CD-rom
- User's manual in English and in pdf-format on the CD-rom
- Cable OPCA-02 for connection between the PC and FlashDrop tool
- Battery charger



FlashDrop tool

Expertise at every stage of the value chain

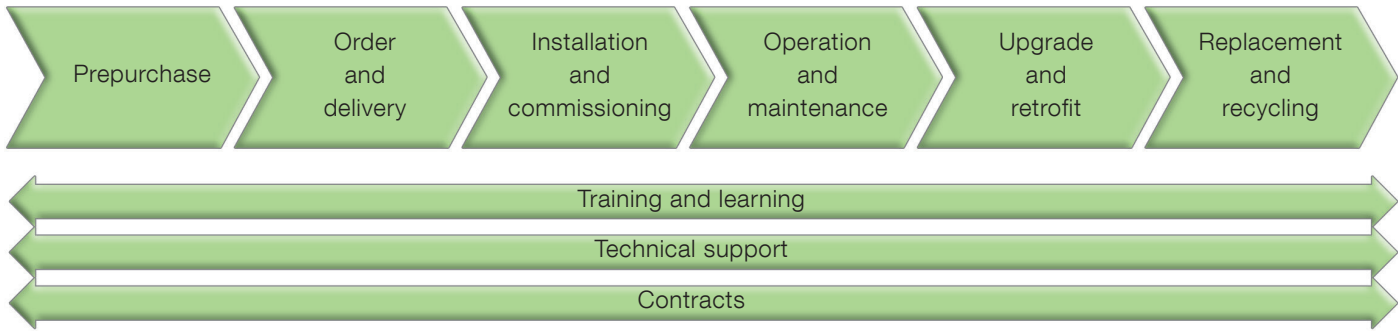

Whether you operate in industry, commerce or a utility your aims remain the same: to keep your motor-driven applications running consistently and efficiently. The life cycle services for ABB drives can help you achieve these aims by maximizing the uptime of your process while ensuring the optimum lifetime of ABB drives in a predictable, safe and low-cost manner.

chain, from the moment you make the first enquiry about a drive through to its disposal and recycling. Throughout the value chain, ABB provides training and learning, technical support and contracts. All of this is supported by one of the most extensive global drive sales and service networks.

The life cycle services for ABB drives span the entire value

Secure uptime throughout the drive life cycle

ABB follows a four-phase model for the life cycle management of its drives. The life cycle phases are active, classic, limited and obsolete. Within each phase, every drive series has a defined set of services.

you with a transparent method for managing your investment in drives. In each phase, you clearly see what life cycle services are available, and more importantly, what services are not available. Decisions on upgrading, retrofitting or replacing drives can be made with confidence.

The four-phase drive life cycle management model provides

ABB drive life cycle management model

