

# Short form user's manual ACS320 drives



Table of contents



Safety



Mechanical installation



Electrical installation



Start-up and control with I/O



# List of related manuals

## Drive manuals

*ACS320 short form user's manual*

*ACS320 user's manual*

## Code (English)

[3AUA0000086933](#)

[3AUA0000062599](#)

## Option manuals and guides

*MFDT-01 FlashDrop user's manual*

*MREL-01 output relay module user's manual*

*MUL1-R1 installation instructions for ACS150, ACS310, ACS320, ACS350 and ACS355*

*MUL1-R3 installation instructions for ACS310, ACS320, ACS350 and ACS355*

*MUL1-R4 installation instructions for ACS310, ACS320, ACS350 and ACS355*

*SREA-01 Ethernet adapter module quick start-up guide*

*SREA-01 Ethernet adapter module user's manual*

[3AFE68591074](#)

[3AUA0000035974](#)

[3AFE68642868](#)

[3AFE68643147](#)

[3AUA0000025916](#)

[3AUA0000042902](#)

[3AUA0000042896](#)

## Maintenance manuals

*Guide for capacitor reforming in ACS50, ACS55, ACS150, ACS310, ACS350, ACS355, ACS550, ACH550 and R1-R4 OINT-/SINT-boards*

[3AFE68735190](#)

You can find manuals and other product documents in PDF format on the Internet. See section [Document library on the Internet](#) on the inside of the back cover. For manuals not available in the Document library, contact your local ABB representative.

## Purpose of the manual

This short form user's manual provides the basic information needed for installing and commissioning the drive.

For information on planning the electrical installation, operation with the control panel, program features, fieldbus, all accessible actual signals and parameters, fault tracing, maintenance, additional technical data and dimension drawings, refer to *ACS320 user's manual* (3AUA0000062599 [English]). To access it on the Internet, go to [www.abb.com/drives](http://www.abb.com/drives), select *Document Library*, enter the code in the search field and click OK.

## Applicability

The manual is applicable to the ACS320 drive firmware version 4.03c or later. See parameter 3301 FIRMWARE in chapter *Actual signals and parameters* in *ACS320 user's manual* (3AUA0000062599 [English]).

# Table of contents

---

List of related manuals .....	2
Purpose of the manual .....	2
Applicability .....	2
<b>1. Safety</b>	
Safety in installation and maintenance .....	5
Safe start-up and operation .....	6
<b>2. Hardware description</b>	
Power connections and control interfaces .....	9
Type designation label .....	10
Type designation key .....	11
<b>3. Mechanical installation</b>	
Installing .....	13
<b>4. Electrical installation</b>	
Checking the compatibility with IT (ungrounded) and corner-grounded TN systems .....	17
Connecting the power cables .....	19
Connecting the control cables .....	21
Installation checklist .....	23
<b>5. Start-up and control with I/O</b>	
How to start up the drive .....	25
How to control the drive through the I/O interface .....	32
<b>6. Actual signals and parameters in the short view</b>	
Terms and abbreviations .....	33
Fieldbus equivalent .....	33
Default values with different macros .....	34
Actual signals in the short parameter view .....	38
Parameters in the short parameter view .....	39
<b>7. Technical data</b>	
Ratings .....	47
Definitions .....	48
Fuses and alternate short-circuit protection .....	50
UL marking .....	53

---



**Further information**

Product and service inquiries .....	57
Product training .....	57
Providing feedback on ABB Drives manuals .....	57
Document library on the Internet .....	57



# 1. Safety

---

## Safety in installation and maintenance

These warnings are intended for all who work on the drive, motor cable or motor.

### ■ Electrical safety

---



**WARNING!** Ignoring the following instructions can cause physical injury or death, or damage to the equipment.

---

- Only qualified electricians are allowed to install and maintain the drive!
- Never work on the drive, motor cable or motor when input power is applied. After disconnecting the input power, always wait for 5 minutes to let the intermediate circuit capacitors discharge before you start working on the drive, motor or motor cable.

Always make sure by measuring with a multimeter (impedance at least 1 Mohm) that there is no voltage between the drive input phases U1, V1 and W1 and the ground.

- Do not work on the control cables when power is applied to the drive or to the external control circuits. Externally supplied control circuits may carry dangerous voltage even when the input power of the drive is switched off.
- Do not make any insulation or voltage withstand tests on the drive.
- Disconnect the internal EMC filter when installing the drive on an IT system (an ungrounded power system or a high-resistance-grounded [over 30 ohms] power system), otherwise the system will be connected to ground potential through the EMC filter capacitors. This may cause danger or damage the drive. See page 17.

**Note:** When the internal EMC filter is disconnected, the drive is not EMC compatible.

- Disconnect the internal EMC filter when installing the drive on a corner-grounded TN system, otherwise the drive will be damaged. See page 17.

**Note:** When the internal EMC filter is disconnected, the drive is not EMC compatible.

- All ELV (extra low voltage) circuits connected to the drive must be used within a zone of equipotential bonding, in other words, within a zone where all simultaneously accessible conductive parts are electrically connected to prevent hazardous voltages appearing between them. This is accomplished by a proper factory grounding.



### Note:

- Even when the motor is stopped, dangerous voltage is present at the power circuit terminals U1, V1, W1 and U2, V2, W2.
- For more technical information, contact the factory or your local ABB sales representative.

### ■ General safety

---



**WARNING!** If you ignore the safety instructions, injury or death can occur. If you are not a qualified electrician, do not do electrical work.

---

- Never attempt to repair a malfunctioning drive. Contact your local ABB representative or Authorized Service Center for service support.
- Make sure that dust from drilling does not enter the drive during the installation. Electrically conductive dust inside the drive may cause damage or lead to malfunction.
- Make sure of sufficient cooling.

### Safe start-up and operation



These warnings are intended for all who plan the operation, start up or operate the drive.



### ■ General safety

---





**WARNING!** Ignoring the following instructions can cause physical injury or death, or damage to the equipment.

---

- Before adjusting the drive and putting it into service, make sure that the motor and all driven equipment are suitable for operation throughout the speed range provided by the drive. The drive can be adjusted to operate the motor at speeds above and below the speed provided by connecting the motor directly to the power line.
  - Do not activate automatic fault reset functions if dangerous situations can occur. When activated, these functions will reset the drive and resume operation after a fault.
  - Do not control the motor with an AC contactor or disconnecting device (disconnecting means). Use the control panel start and stop keys  and  or external commands (I/O or fieldbus). The maximum number of charging cycles allowed with the DC capacitors (i.e power-ups by applying power) is two per minute and the maximum total number of chargings is 15 000.
-

**Note:**

- If an external source is selected for start command, and it is ON, the drive starts immediately after an input voltage break or fault reset unless the drive is configured for 3-wire (a pulse) start/stop.
- When the control location is not set to local (LOC not shown on the display), the stop key on the control panel will not stop the drive. To stop the drive using the control panel, press the LOC/REM key  and then press the stop key .







# 2. Hardware description

## Power connections and control interfaces

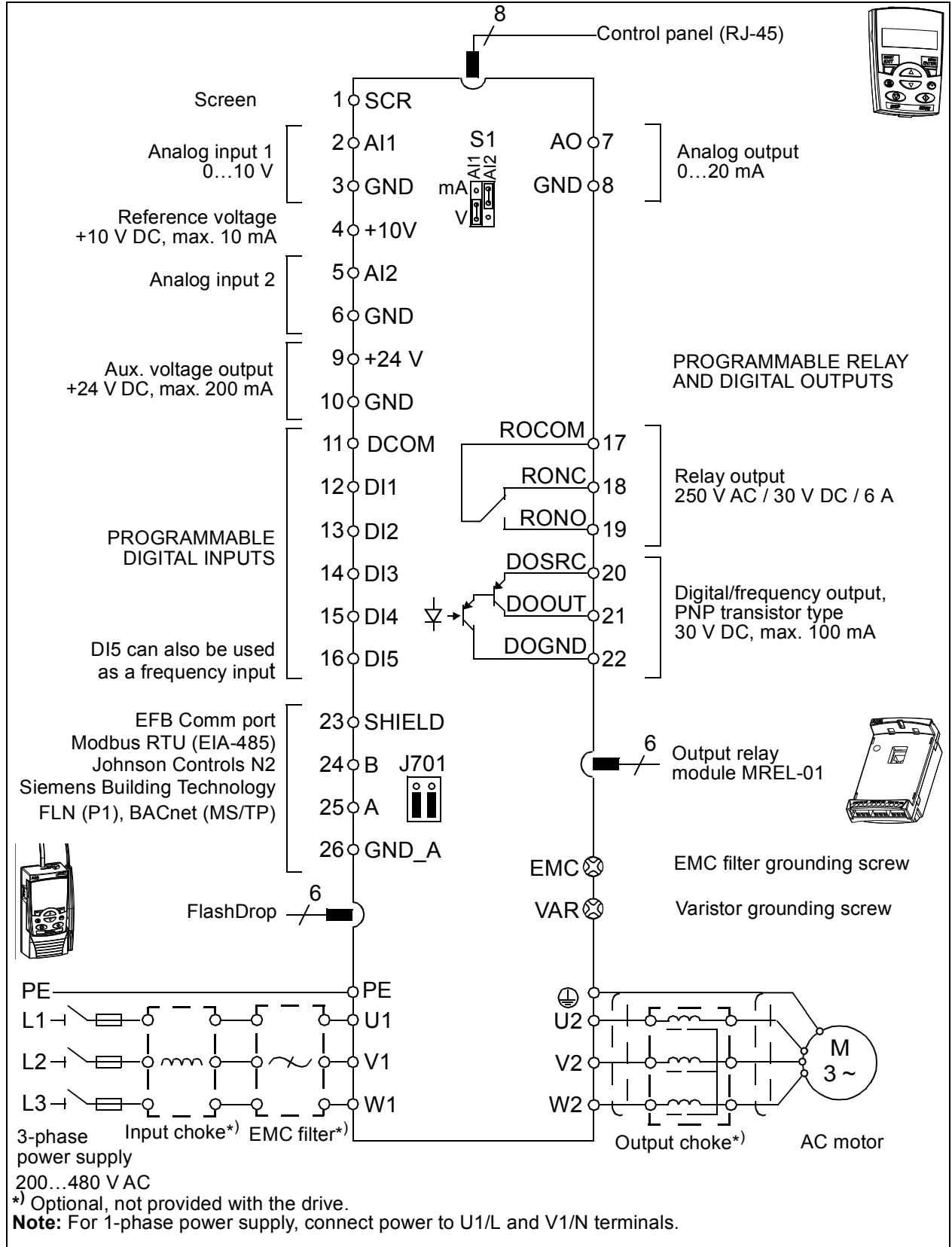

## Type designation label

The type designation label is attached to the left side of the drive. An example label and explanation of the label contents are shown below.

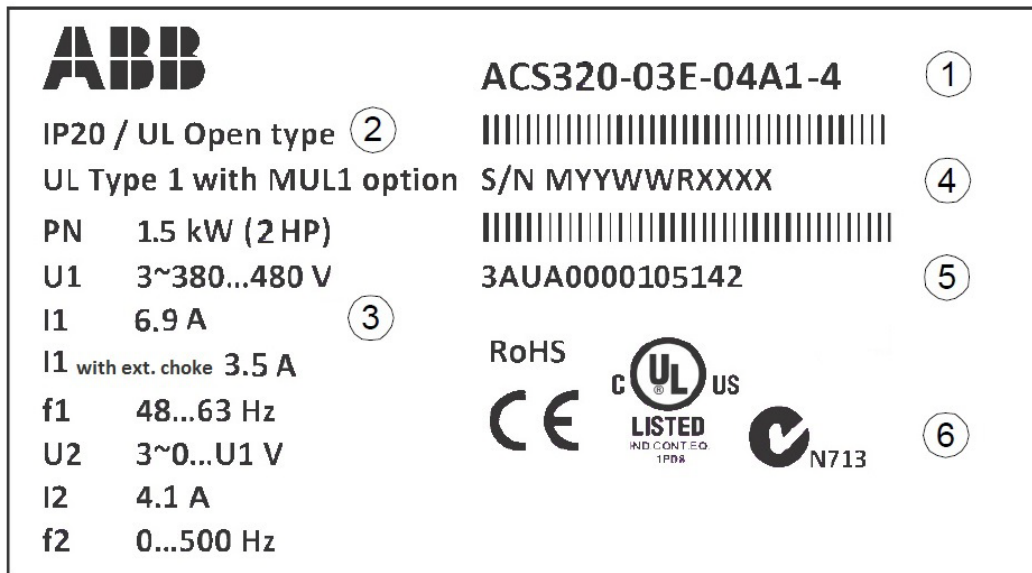

1	Type designation, see section <a href="#">Type designation key</a> on page 11
2	Degree of protection by enclosure (IP and UL/NEMA)
3	Nominal ratings, see section <a href="#">Ratings</a> on page 47 or <a href="#">Definitions</a> on page 48.
4	Serial number of format MYYWWRXXXX, where M: Manufacturer YY: 09, 10, 11, ... for 2009, 2010, 2011, ... WW: 01, 02, 03, ... for week 1, week 2, week 3, ... R: A, B, C, ... for product revision number XXXX: Integer starting every week from 0001
5	ABB MRP code of the drive
6	CE marking and C-Tick, C-UL US and RoHS marks (the label of your drive shows the valid markings)

## Type designation key

The type designation contains information on the specifications and configuration of the drive. You find the type designation on the type designation label attached to the drive. The first digits from the left express the basic configuration, for example, ACS320-03E-08A8-4. The optional selections are given after that, separated by + signs, for example +J404. The explanations of the type designation selections are described below.

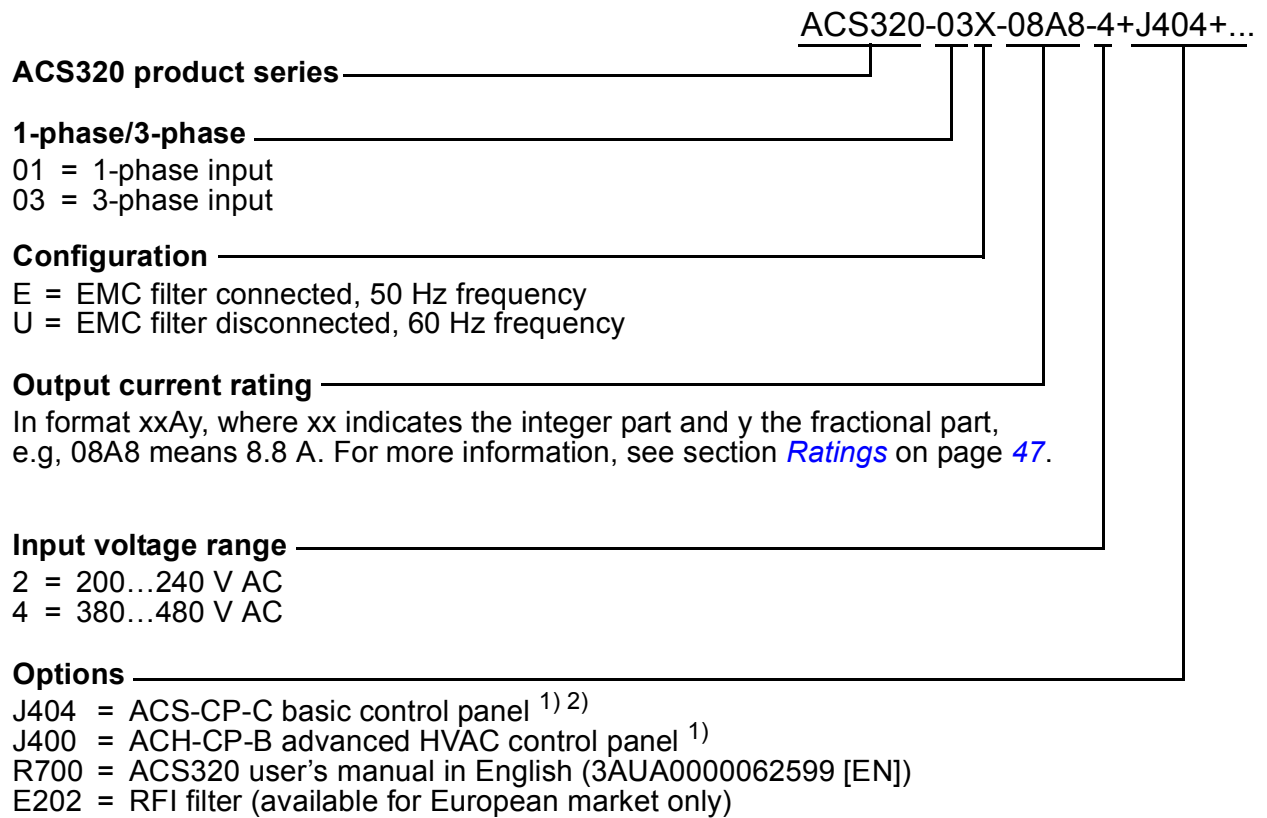

<sup>1)</sup> The ACS320 is compatible with panels that have the following panel revisions and panel firmware versions. To find out the revision and firmware version of your panel, see chapter *Control panels*, section *Applicability* in *ACS320 user's manual* (3AUA0000062599 [English]).

Panel type	Type code	Panel revision	Panel firmware version
Basic control panel <sup>2)</sup>	ACS-CP-C	M or later	1.13 or later
Advanced HVAC control panel	ACH-CP-B	X or later	2.04 or later

<sup>2)</sup> Available for North American market only.



# 3. Mechanical installation

## Installing

The instructions in this manual cover drives with the IP20 degree of protection. To comply with NEMA 1, use the MUL1-R1, MUL1-R3 or MUL1-R4 option kit, which is delivered with multilingual installation instructions (3AFE68642868, 3AFE68643147 or 3AUA0000025916, respectively).

### ■ Install the drive

Install the drive with screws or on a DIN rail as appropriate.

The required free space for cooling above and below the drive is 75 mm (3 in). No free space is required on the sides, so drives can be mounted immediately next to each other.

**Note:** Make sure that dust from drilling does not enter the drive during the installation.

### With screws

1. Mark the hole locations using for example the mounting template cut out from the package. The locations of the holes are also shown in the drawings in chapter *Dimension drawings* in *ACS320 user's manual* (3AUA0000062599 [English]). The number and location of the holes used depend on how the drive is installed:
  - a) back mounting (frame sizes R0...R4): four holes
  - b) side mounting (frame sizes R0...R2): three holes; one of the bottom holes is located in the clamping plate.
2. Fix the screws or bolts to the marked locations.

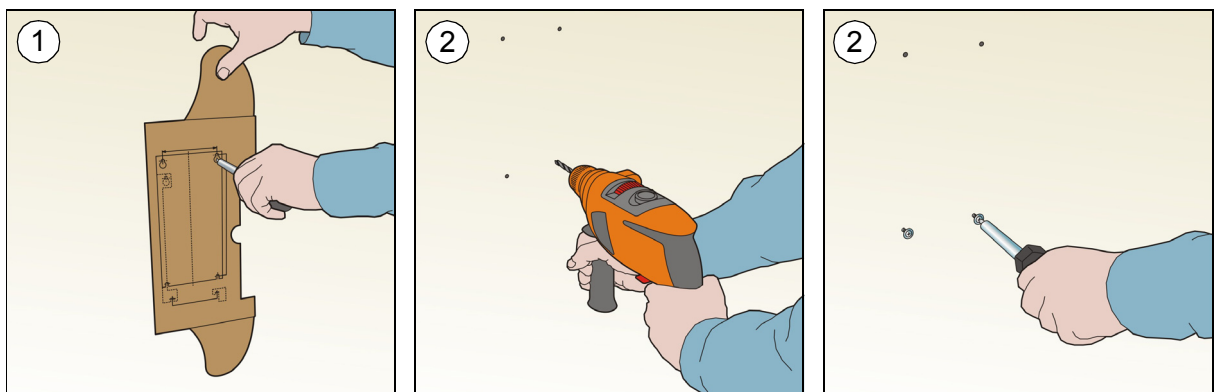

## 14 Mechanical installation

3. Position the drive onto the screws on the wall.
4. Tighten the screws in the wall securely.

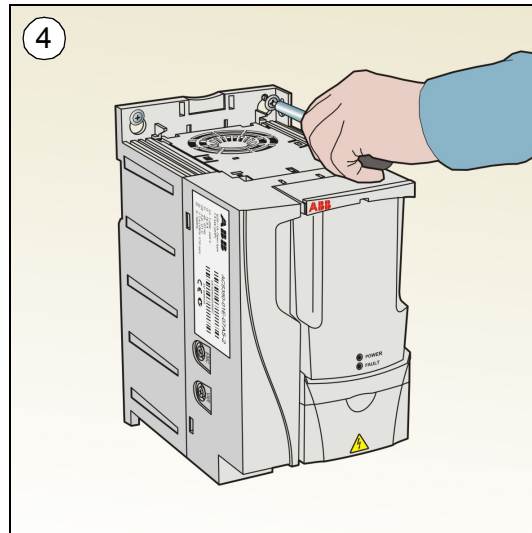
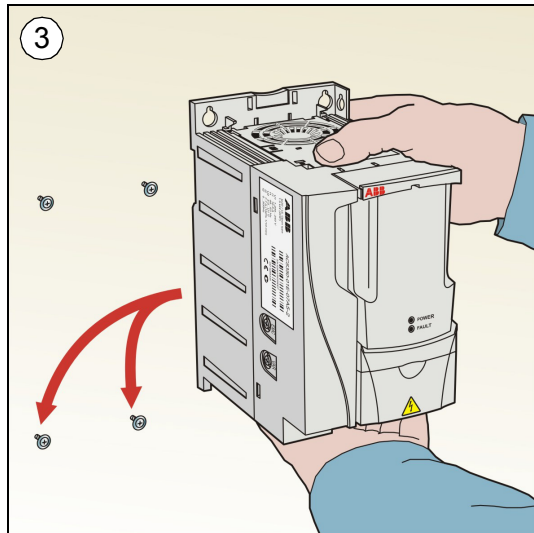

### On DIN rail

- Click the drive to the rail.
- To detach the drive, press the release lever on top of the drive (1b).

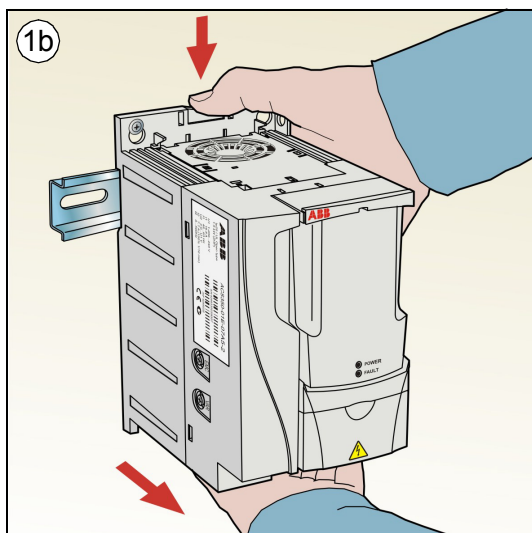
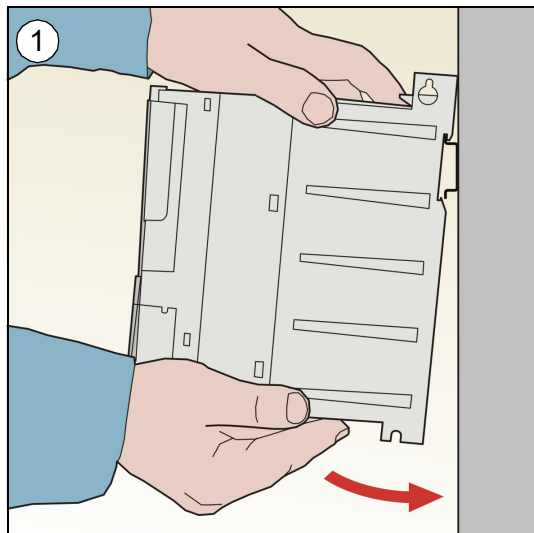

## ■ Fasten clamping plates

1. Fasten the clamping plate to the plate at the bottom of the drive with the provided screws.
2. For frame sizes R0...R2, fasten the I/O clamping plate to the clamping plate with the provided screws.

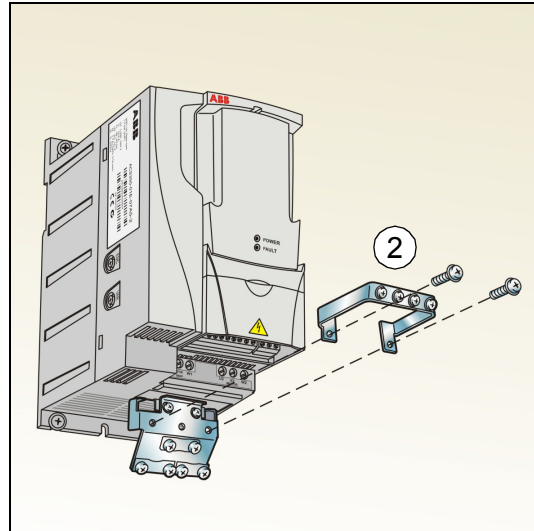
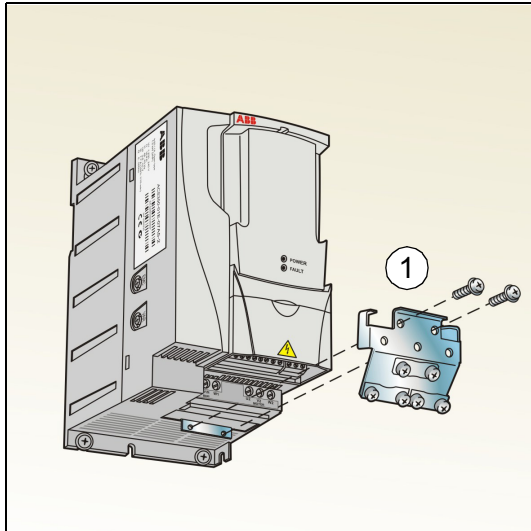





# 4. Electrical installation

---



**WARNING!** Obey the safety instructions. See chapter [Safety](#) on page 5. If you ignore the safety instructions, injury or death can occur. If you are not a qualified electrician, do not do electrical work.

Make sure that the drive is disconnected from the input power during installation. If the drive is already connected to the input power, wait for 5 minutes after disconnecting the input power.

---

## Checking the compatibility with IT (ungrounded) and corner-grounded TN systems

---



**WARNING!** Disconnect the internal EMC filter when installing the drive on an IT system (an ungrounded power system or a high-resistance-grounded [over 30 ohms] power system), otherwise the system will be connected to ground potential through the EMC filter capacitors. This may cause danger or damage the drive.

Disconnect the internal EMC filter when installing the drive on a corner-grounded TN system, otherwise the drive will be damaged.

**Note:** When the internal EMC filter is disconnected, the drive is not EMC compatible without an external filter.

---

1. If you have an IT (ungrounded) or corner grounded TN system, disconnect the internal EMC filter by removing the EMC screw. For 3-phase U-type drives (with type designation ACS320-03U-), the EMC screw is already removed at the factory and replaced by a plastic one.  
Pay attention to the screws! Do not confuse the EMC screw to the similar varistor disconnecting screw. Do not disconnect the varistor. The varistor protects the drive against power line voltage peaks.



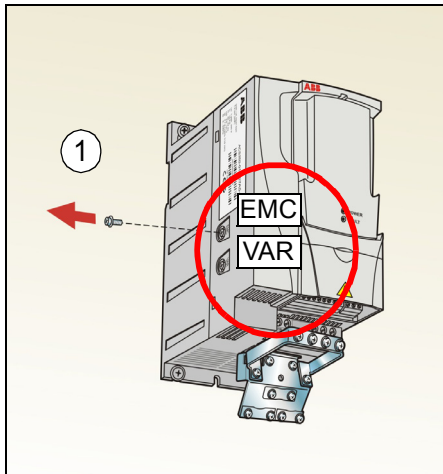

**Note:** In frame size R4 the EMC screw is located to the right of terminal W2.

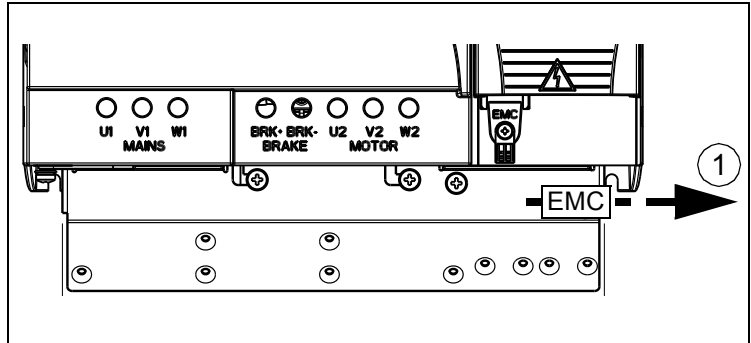

## Connecting the power cables

### ■ Connection diagram

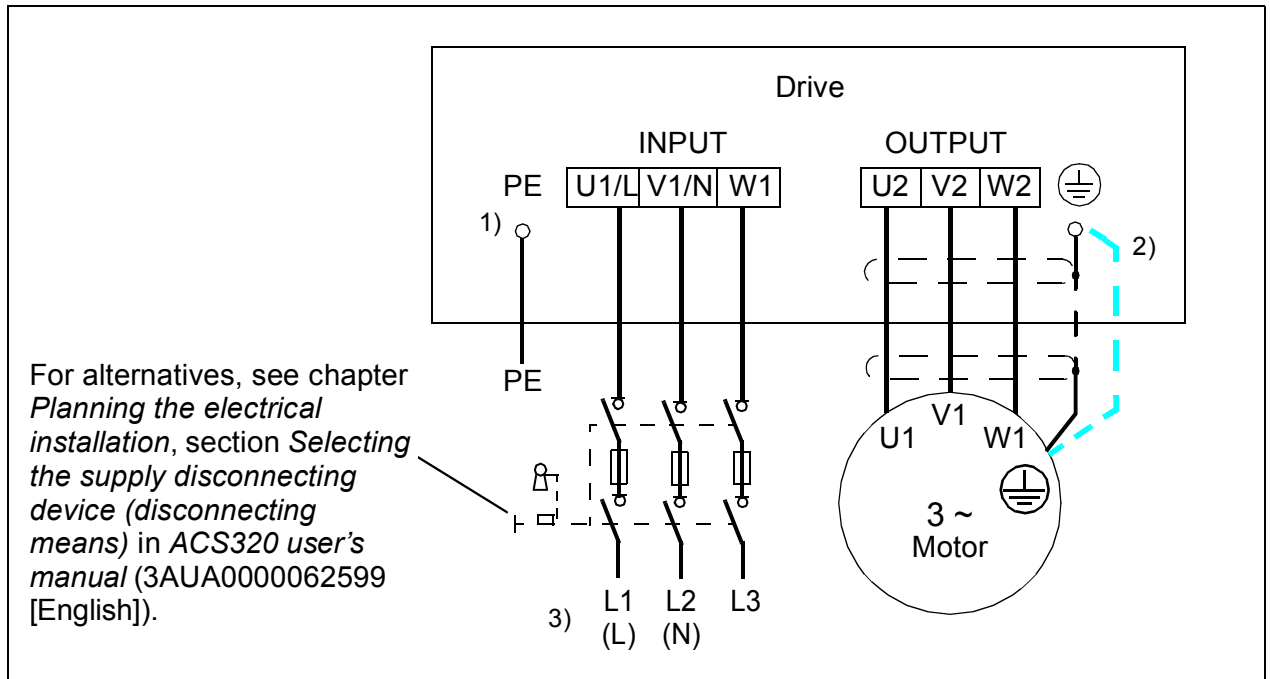

- 1) Ground the other end of the PE conductor at the distribution board.
- 2) Use a separate grounding cable if the conductivity of the cable shield is insufficient (smaller than the conductivity of the phase conductor) and there is no symmetrically constructed grounding conductor in the cable. See chapter *Planning the electrical installation*, section *Selecting the power cables* in *ACS320 user's manual (3AUA0000062599 [English])*.
- 3) L and N are connection markings for the 1-phase power supply.

#### Note:

- Do not use an asymmetrically constructed motor cable.
- If there is a symmetrically constructed grounding conductor in the motor cable in addition to the conductive shield, connect the grounding conductor to the grounding terminal at the drive and motor ends.
- For the 1-phase power supply, connect power to terminals U1/L and V1/N.
- Route the motor cable, input power cable and control cables separately. For more information, see chapter *Planning the electrical installation*, section *Routing the cables* in *ACS320 user's manual (3AUA0000062599 [English])*.

#### Grounding of the motor cable shield at the motor end

For minimum radio frequency interference:

- ground the cable by twisting the shield as follows: flattened width  $\geq 1/5 \cdot \text{length}$
- or ground the cable shield 360 degrees at the lead-through of the motor terminal box.

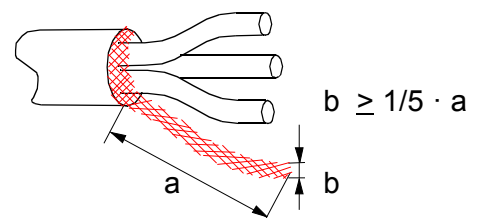

## ■ Connection procedure

1. Fasten the grounding conductor (PE) of the input power cable under the grounding clamp. Connect the phase conductors to the U1, V1 and W1 terminals. Use a tightening torque of 0.8 N·m (7 lbf·in) for frame sizes R0...R2, 1.7 N·m (15 lbf·in) for R3, and 2.5 N·m (22 lbf·in) for R4.
2. Strip the motor cable and twist the shield to form as short a pigtail as possible. Fasten the twisted shield under the grounding clamp. Connect the phase conductors to the U2, V2 and W2 terminals. Use a tightening torque of 0.8 N·m (7 lbf·in) for frame sizes R0...R2, 1.7 N·m (15 lbf·in) for R3, and 2.5 N·m (22 lbf·in) for R4.
3. Secure the cables outside the drive mechanically.

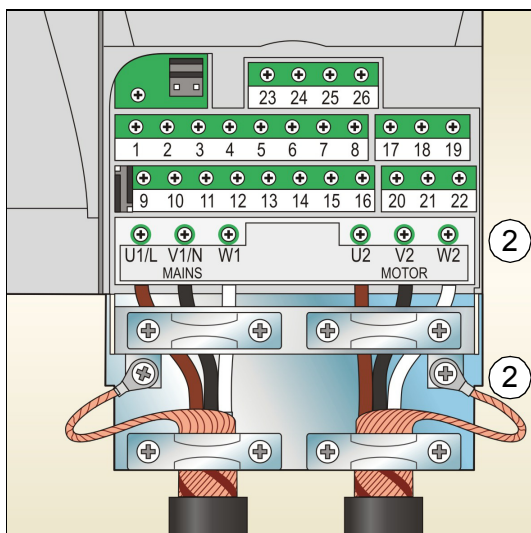
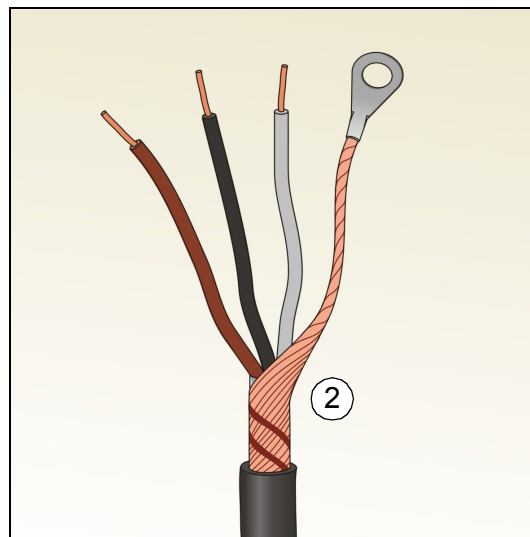
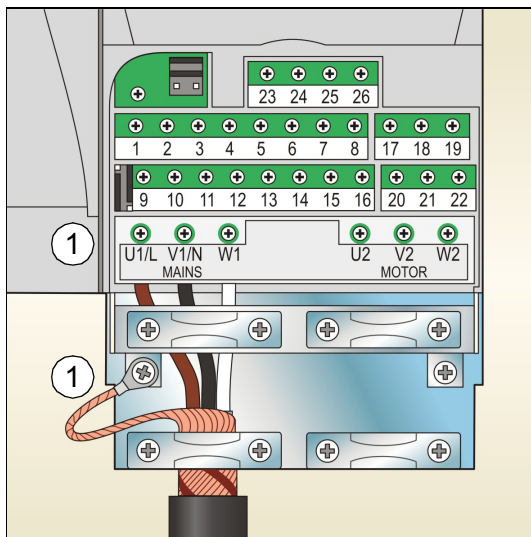

## Connecting the control cables

### ■ Default I/O connection diagram

The default connection of the control signals depends on the application macro in use, which is selected with parameter [9902 APPLIC MACRO](#).

The default macro is the HVAC Default macro. It provides a general purpose I/O configuration with three constant speeds. Parameter values are the default values given in chapter *Actual signals and parameters* in *ACS320 user's manual* (3AUA0000062599 [English]).

The default I/O connections for the HVAC Default macro are given in the figure below.

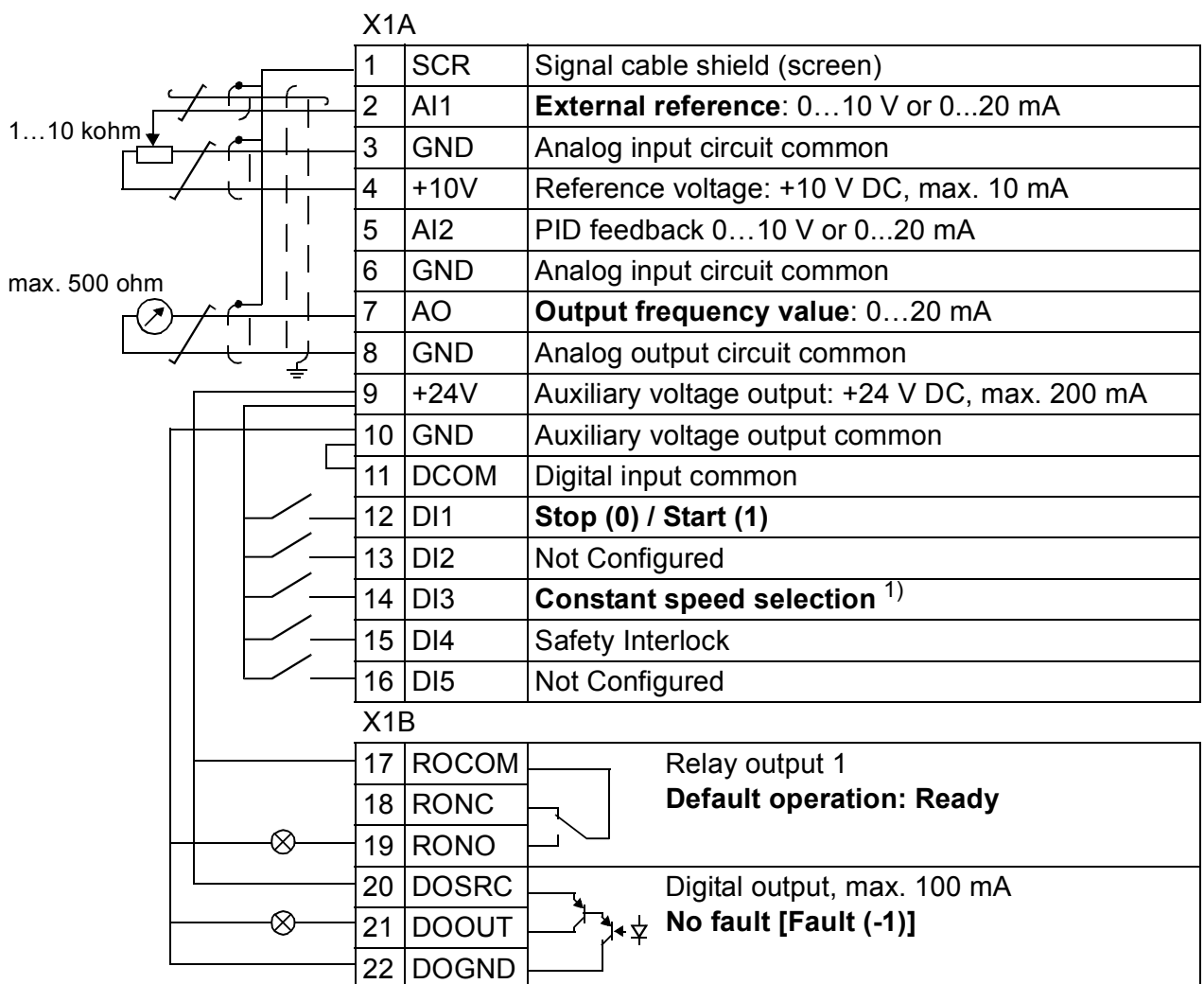

<sup>1)</sup> See parameter group [12 CONSTANT SPEEDS](#):

DI3	Operation (parameter)
0	Set speed through AI1
1	Speed 1 ( <a href="#">1202</a> )
0	Speed 2 ( <a href="#">1203</a> )
1	Speed 3 ( <a href="#">1204</a> )

<sup>2)</sup> 360 degree grounding under a clamp.  
Tightening torque: 0.4 N.m (3.5 lbf.in).

## ■ Connection procedure

1. Remove the terminal cover by simultaneously pushing the recess and sliding the cover off the frame.
2. *Digital signals:* Strip the outer insulation of the digital signal cable 360 degrees and ground the bare shield under the clamp.
3. Connect the conductors of the cable to the appropriate terminals. Use a tightening torque of 0.4 N·m (3.5 in-lb).
4. For double-shielded cables, twist also the grounding conductors of each pair in the cable together and connect the bundle to the SCR terminal (terminal 1).

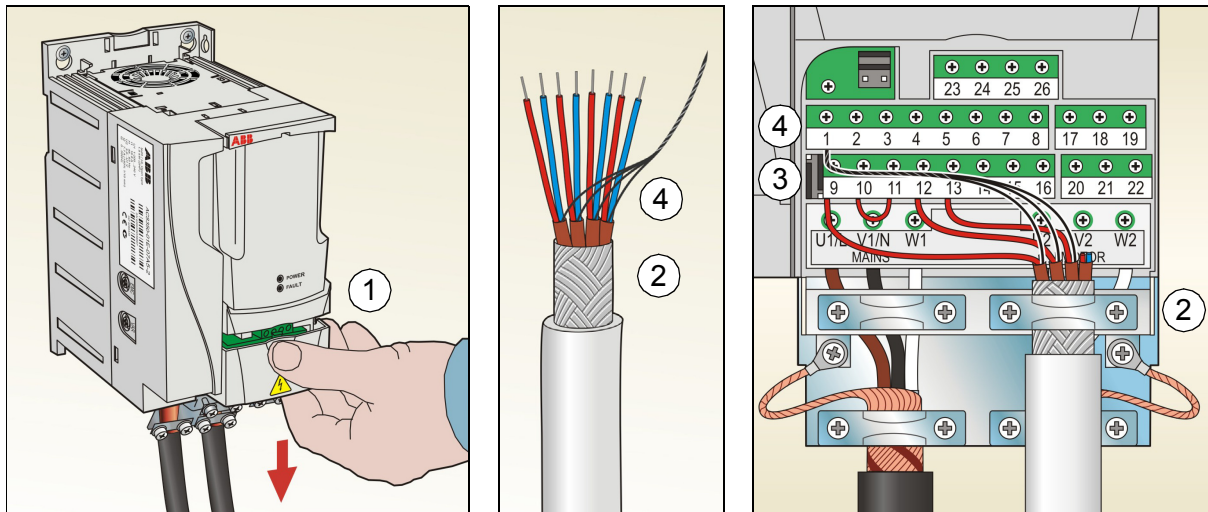

5. *Analog signals:* Strip the outer insulation of the analog signal cable 360 degrees and ground the bare shield under the clamp.
6. Connect the conductors to the appropriate terminals. Use a tightening torque of 0.4 N·m (3.5 in-lb).
7. Twist the grounding conductors of each pair in the analog signal cable together and connect the bundle to the SCR terminal (terminal 1).
8. Secure all cables outside the drive mechanically.
9. Slide the terminal cover back in place.

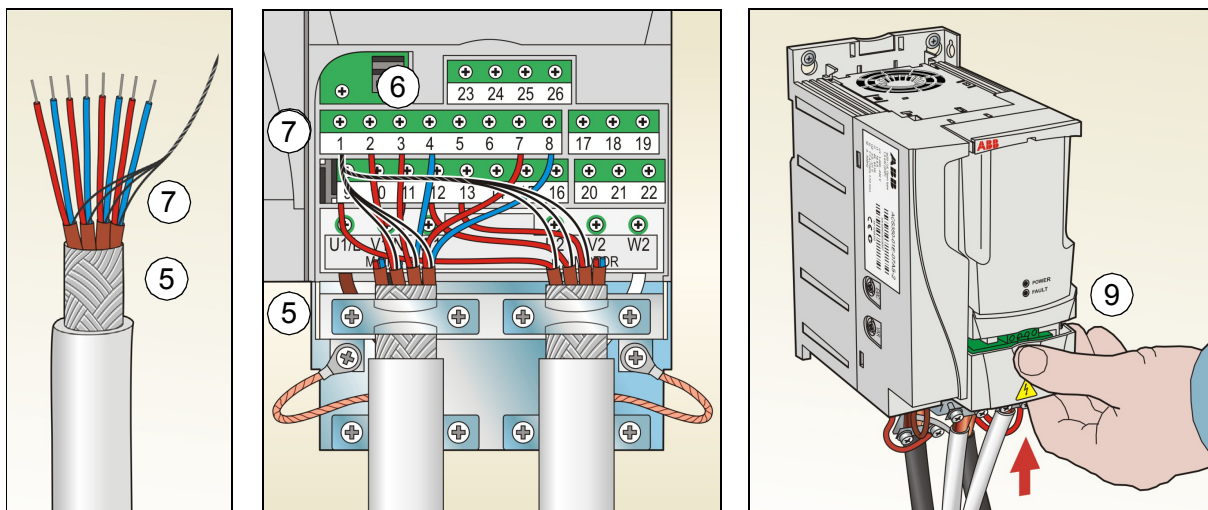

## Installation checklist

Check the mechanical and electrical installation of the drive before start-up. Go through the checklist below together with another person. Read chapter [Safety](#) on page 5 before you work on the drive.

Check
<b>MECHANICAL INSTALLATION</b>
<input type="checkbox"/> The ambient operating conditions are within allowed limits. (See <i>Technical data: Losses, cooling data and noise</i> and <i>Ambient conditions</i> in <i>ACS320 user's manual</i> (3AUA0000062599 [English]).)
<input type="checkbox"/> The drive is fixed properly on an even vertical non-flammable wall. (See <a href="#">Mechanical installation</a> on page 13 and <i>Mechanical installation</i> in <i>ACS320 user's manual</i> (3AUA0000062599 [English]).)
<input type="checkbox"/> The cooling air flows freely. (See <a href="#">Mechanical installation: Install the drive</a> on page 13.)
<input type="checkbox"/> The motor and the driven equipment are ready for start. (See <i>Planning the electrical installation: Checking the compatibility of the motor and drive</i> as well as <i>Technical data: Motor connection data</i> in <i>ACS320 user's manual</i> (3AUA0000062599 [English]).)
<b>ELECTRICAL INSTALLATION</b> (See <a href="#">Electrical installation</a> on page 17 and <i>Planning the electrical installation</i> in <i>ACS320 user's manual</i> (3AUA0000062599 [English]).)
<input type="checkbox"/> For ungrounded and corner-grounded systems: The internal EMC filter is disconnected (EMC screw removed).
<input type="checkbox"/> The capacitors are reformed if the drive has been stored over a year.
<input type="checkbox"/> The drive is grounded properly.
<input type="checkbox"/> The input power voltage matches the drive nominal input voltage.
<input type="checkbox"/> The input power connections at U1, V1 and W1 are OK and tightened with the correct torque.
<input type="checkbox"/> Appropriate input power fuses and disconnectors are installed.
<input type="checkbox"/> The motor connections at U2, V2 and W2 are OK and tightened with the correct torque.
<input type="checkbox"/> The motor cable, input power cable and control cables are routed separately.
<input type="checkbox"/> The external control (I/O) connections are OK.
<input type="checkbox"/> The input power voltage cannot be applied to the output of the drive (with a bypass connection).
<input type="checkbox"/> Terminal cover and, for NEMA 1, hood and connection box, are in place.







# 5. Start-up and control with I/O

---

## How to start up the drive

---



**WARNING!** Only qualified electricians are allowed to start-up or operate the drive.

Obey the safety instructions. See chapter [Safety](#) on page 5.

Before adjusting the drive and putting it into service, make sure that the motor and all driven equipments are suitable for operation throughout the speed range provided by the drive. The drive can be adjusted to operate the motor at speeds above and below the speed provided by connecting the motor directly to the power line.

If an external source for start command is selected and it is ON, the drive will start immediately after an input voltage break or fault reset unless the drive is configured for 3-wire (a pulse) start/stop.

---

**Note:** By default, parameter [1611 PARAMETER VIEW](#) is set to 2 ([SHORT VIEW](#)), and you cannot see all actual signals and parameters. To be able to view them, set parameter [1611 PARAMETER VIEW](#) to 3 ([LONG VIEW](#)).

- Check the installation. See the checklist in section [Installation checklist](#) on page 23.

How you start up the drive depends on the control panel you have.

- **If you have a Basic control panel**, follow the instructions given in section [How to perform a manual start-up](#) on page 26.
- **If you have an Advanced HVAC control panel**, you can either run the Start-up assistant (see section [How to perform a guided start-up](#) on page 29) or perform a manual start-up (see section [How to perform a manual start-up](#) on page 26).

The Start-up assistant, which is included in the Advanced HVAC control panel only, guides you through all essential settings to be done. In the manual start-up, the drive gives no guidance; you go through the very basic settings by following the instructions given in section [How to perform a manual start-up](#) on page 26.



## How to perform a manual start-up

For the manual start-up, you can use the Basic control panel or the Advanced HVAC control panel. The instructions below are valid for both control panels, but the displays shown are the Basic control panel displays, unless the instruction applies to the Advanced HVAC control panel only.

Before you start, make sure that you have the motor nameplate data on hand.

**POWER-UP**

Apply input power.

The Basic control panel powers up into the Output mode.

The Advanced HVAC control panel asks if you want to run the Start-up assistant. If you press , the Start-up assistant is not run, and you can continue with manual start-up in a similar manner as described below for the Basic control panel.

REM 0.0 Hz

OUTPUT FWD

---

REM ↻ CHOICE

Do you want to use the start-up assistant?

**Yes**

No

EXIT | 00:00 | OK

**MANUAL ENTRY OF START-UP DATA (parameter group 99)**

If you have an Advanced HVAC control panel, select the language (the Basic control panel does not support languages). See parameter [9901](#) for the values of the available language alternatives.

For instructions on how to set parameters with the Advanced HVAC control panel, see chapter *Control panels*, section *Advanced HVAC control panel in ACS320 user's manual* (3AUA0000062599 [English]).

Enter the motor data from the motor nameplate:

REM ↻ PAR EDIT

9901 LANGUAGE

**ENGLISH**

[0]

CANCEL | 00:00 | SAVE

**Note:** Set the motor data to exactly the same value as on the motor nameplate. For example, if the nominal motor speed is 1470 rpm on the nameplate, setting the value of parameter [9908 MOTOR NOM SPEED](#) to 1500 rpm results in the wrong operation of the drive.

















<b>ABB Motors</b> 							
3 ~ motor		M2AA 200 MLA 4					
IEC 200 M/L 55				↔			
No							
Ins.cl. F				IP 55			
V	Hz	kW	r/min	A	cos φ	IA/IN	tE/s
690 Y	50	30	1475	32.5	0.83		
400 D	50	30	1475	56	0.83		
660 Y	50	30	1470	34	0.83		
380 D	50	30	1470	59	0.83		
415 D	50	30	1475	54	0.83		
440 D	60	35	1770	59	0.83		
Cat. no 3GAA 202 001 - ADA							
6312/C3				6210/C3		180 kg	
IEC 34-1							

380 V supply voltage

- nominal motor voltage (parameter [9905](#))

Setting of parameter [9905](#) is shown below as an example of parameter setting with the Basic control panel. You find more detailed instructions in chapter *Control panels*, section *Basic control panel* in *ACS320 user's manual* (3AUA0000062599 [English]).

1. To go to the Main menu, press  if the bottom line shows OUTPUT; otherwise press  repeatedly until you see MENU at the bottom.
2. Press keys   until you see "PAR", and press .
3. Find the appropriate parameter group with keys   and press .
4. Find the appropriate parameter in the group with keys  .
5. Press and hold  for about two seconds until the parameter value is shown with **SET** under the value.
6. Change the value with keys  . The value changes faster while you keep the key pressed down.
7. Save the parameter value by pressing .

Enter the rest of the motor data:

- nominal motor current (parameter [9906](#))  
Allowed range:  $0.2 \dots 2.0 \cdot I_{2N}$  A
- nominal motor frequency (parameter [9907](#))
- nominal motor speed (parameter [9908](#))
- nominal motor power (parameter [9909](#))

- Select the application macro (parameter [9902](#)) according to how the control cables are connected. The default value 1 (*HVAC DEFAULT*) is suitable in most cases.

REM 9905  
PAR FWD

REM rEF  
MENU FWD

REM -01-  
PAR FWD

REM 9901  
PAR FWD

REM 9905  
PAR FWD

REM 400<sup>V</sup>  
PAR SET FWD

REM 380<sup>V</sup>  
PAR SET FWD

REM 9905  
PAR FWD

REM 9906  
PAR FWD

REM 9907  
PAR FWD









REM 9908  
PAR FWD

REM 9909  
PAR FWD

REM 9902  
PAR FWD



**DIRECTION OF THE MOTOR ROTATION**

- Check the direction of the motor rotation.
  - If the drive is in remote control (REM shown on the left), switch to local control by pressing .
  - To go to the Main menu, press  if the bottom line shows OUTPUT; otherwise press  repeatedly until you see MENU at the bottom.
  - Press keys   until you see “rEF” and press .
  - Increase the frequency reference from zero to a small value with key .
  - Press  to start the motor.
  - Check that the actual direction of the motor is the same as indicated on the display (FWD means forward and REV reverse).
  - Press  to stop the motor.

To change the direction of the motor rotation:

- If parameter 9914 PHASE INVERSION is not visible, first set parameter **1611 PARAMETER VIEW** to 3 (**LONG VIEW**).
- Invert the phases by changing the value of parameter 9914 o the opposite, ie from 0 (NO) to 1 (YES), or vice versa.
- Verify your work by applying input power and repeating the check as described above. Set parameter **1611** back to 2 (**SHORT VIEW**).

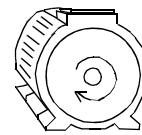

forward direction

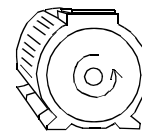

reverse direction

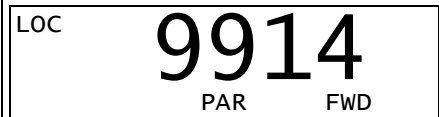

**FINAL CHECK**

- Check that the drive state is OK.
 

Basic control panel: Check that there are no faults or alarms shown on the display. If you want to check the LEDs on the front of the drive, switch first to remote control (otherwise a fault is generated) before removing the panel and verifying that the red LED is not lit and the green LED is lit but not blinking.

Advanced HVAC control panel: Check that there are no faults or alarms shown on the display and that the panel LED is green and does not blink.













**The drive is now ready for use.**



## ■ How to perform a guided start-up

To be able to perform the guided start-up, you need the Advanced HVAC control panel.





Before you start, make sure that you have the motor nameplate data on hand.

POWER-UP	
<p><input type="checkbox"/> Apply input power. The control panel first asks if you want to use the Start-up assistant.</p> <ul style="list-style-type: none"> <li>• Press  (when <b>Yes</b> is highlighted) to run the Start-up assistant.</li> <li>• Press  if you do not want to run the Start-up assistant.</li> <li>• Press key  to highlight <b>No</b> and then press  if you want to make the panel ask (or not ask) the question about running the Start-up assistant again the next time you switch on the power to the drive.</li> </ul>	<div style="border: 1px solid black; padding: 5px; margin-bottom: 10px;"> <p>REM ↻ CHOICE</p> <p>Do you want to use the start-up assistant?</p> <p><b>Yes</b></p> <p>NO</p> <p>EXIT   00:00   OK</p> </div> <div style="border: 1px solid black; padding: 5px;"> <p>REM ↻ CHOICE</p> <p>Show start-up assistant on next boot?</p> <p><b>Yes</b></p> <p>NO</p> <p>EXIT   00:00   OK</p> </div>
SELECTING THE LANGUAGE	
<p><input type="checkbox"/> If you decided to run the Start-up assistant, the display then asks you to select the language. Scroll to the desired language with keys / and press  to accept.</p> <p>If you press , the Start-up assistant is stopped.</p>	<div style="border: 1px solid black; padding: 5px;"> <p>REM ↻ PAR EDIT</p> <p>9901 LANGUAGE</p> <p><b>ENGLISH</b></p> <p>[0]</p> <p>EXIT   00:00   SAVE</p> </div>
STARTING THE GUIDED SET-UP	
<p><input type="checkbox"/> The Start-up assistant now guides you through the set-up tasks, starting with the motor set-up. Set the motor data to exactly the same value as on the motor nameplate.</p> <p>Scroll to the desired parameter value with keys / and press  to accept and continue with the Start-up assistant.</p> <p><b>Note:</b> At any time, if you press , the Start-up assistant is stopped and the display goes to the Output mode.</p> <p><input type="checkbox"/> The basic start-up is now completed. However, it might be useful at this stage to set the parameters required by your application and continue with the application set-up as suggested by the Start-up assistant.</p>	<div style="border: 1px solid black; padding: 5px; margin-bottom: 10px;"> <p>REM ↻ PAR EDIT</p> <p>9905 MOTOR NOM VOLT</p> <p><b>220 V</b></p> <p>EXIT   00:00   SAVE</p> </div> <div style="border: 1px solid black; padding: 5px;"> <p>REM ↻ CHOICE</p> <p>Do you want to continue with application setup?</p> <p><b>Continue</b></p> <p>Skip</p> <p>EXIT   00:00   OK</p> </div>



- Select the application macro according to which the control cables are connected.

Continue with the application set-up. After completing a set-up task, the Start-up assistant suggests the next one.

- Press  (when **Continue** is highlighted) to continue with the suggested task.
- Press key  to highlight **Skip** and then press  to move to the following task without doing the suggested task.
- Press  to stop the Start-up assistant.





```

REM  ↻ PAR EDIT
9902 APPLIC MACRO
HVAC DEFAULT
[1]
EXIT | 00:00 | SAVE
    
```

```

REM  ↻ CHOICE
Do you want to
continue with
EXT1 reference setup?
Continue
Skip
EXIT | 00:00 | OK
    
```

### DIRECTION OF THE MOTOR ROTATION

- Check the direction of the motor rotation.
  - If the drive is in remote control (REM shown on the status line), switch to local control by pressing .
  - If you are not in the Output mode, press  repeatedly until you get there.
  - Increase the frequency reference from zero to a small value with key .
  - Press  to start the motor.
  - Check that the actual direction of the motor is the same as indicated on the display (↻ means forward and ↺ reverse).
  - Press  to stop the motor.

To change the direction of the motor rotation:

- If parameter 9914 PHASE INVERSION is not visible, first set parameter **1611 PARAMETER VIEW** to 3 (**LONG VIEW**).
- Invert the phases by changing the value of parameter 9914 to the opposite, ie from 0 (NO) to 1 (YES), or vice versa.
- Verify your work by applying input power and repeating the check as described above.
- Set parameter **1611** back to 2 (**SHORT VIEW**).

```

LOC  ↻ XX.XHZ
XX.X HZ
X.X A
XX.X %
DIR | 00:00 | MENU
    
```



```

LOC  ↻ PAR EDIT
1611 PARAMETER VIEW
LONG VIEW
[3]
CANCEL | 00:00 | SAVE
    
```

```

LOC  ↻ PAR EDIT
9914 PHASE INVERSION
YES
[1]
CANCEL | 00:00 | SAVE
    
```



**FINAL CHECK**

- After the whole set-up is completed, check that there are no faults or alarms shown on the display and the panel LED is green and does not blink.

**The drive is now ready for use.**



## How to control the drive through the I/O interface

The table below instructs how to operate the drive through the digital and analog inputs when:

- the motor start-up is performed, and
- the default (standard) parameter settings are valid.

The below examples show the Basic control panel display.

PRELIMINARY SETTINGS													
<p>If you need to change the direction of rotation, check that parameter 1003 DIRECTION is set to 3 (REQUEST).</p> <p>Make sure that the control connections are wired according to the connection diagram for <i>HVAC DEFAULT</i> macro.</p> <p>Make sure that the drive is in remote control. Press key  to switch between remote and local control.</p>	<p>See <a href="#">Default I/O connection diagram</a> on page 21.</p> <p>In remote control, the panel display the text REM.</p>												
STARTING AND CONTROLLING THE SPEED OF THE MOTOR													
<p>Start by switching digital input DI1 on.</p> <p><u>Basic control panel</u>: Text FWD starts flashing fast and stops after the setpoint is reached</p> <p><u>Advanced HVAC control panel</u>: The arrow starts rotating. It is dotted until the setpoint is reached.</p> <p>Regulate the drive output frequency (motor speed) by adjusting the voltage of analog input AI1.</p>	<table border="1" style="width: 100%; text-align: center;"> <tr> <td style="padding: 5px;">REM</td> <td style="font-size: 2em; padding: 5px;">0.0</td> <td style="padding: 5px;">Hz</td> </tr> <tr> <td style="padding: 5px;">OUTPUT</td> <td style="padding: 5px;">FWD</td> <td></td> </tr> </table> <table border="1" style="width: 100%; text-align: center;"> <tr> <td style="padding: 5px;">REM</td> <td style="font-size: 2em; padding: 5px;">50.0</td> <td style="padding: 5px;">Hz</td> </tr> <tr> <td style="padding: 5px;">OUTPUT</td> <td style="padding: 5px;">FWD</td> <td></td> </tr> </table>	REM	0.0	Hz	OUTPUT	FWD		REM	50.0	Hz	OUTPUT	FWD	
REM	0.0	Hz											
OUTPUT	FWD												
REM	50.0	Hz											
OUTPUT	FWD												
CHANGING THE DIRECTION OF ROTATION OF THE MOTOR													
<p>Reverse direction: Switch digital input DI2 on.</p> <p>Forward direction: Switch digital input DI2 off.</p>	<table border="1" style="width: 100%; text-align: center;"> <tr> <td style="padding: 5px;">REM</td> <td style="font-size: 2em; padding: 5px;">50.0</td> <td style="padding: 5px;">Hz</td> </tr> <tr> <td style="padding: 5px;">OUTPUT</td> <td style="padding: 5px;">REV</td> <td></td> </tr> </table> <table border="1" style="width: 100%; text-align: center;"> <tr> <td style="padding: 5px;">REM</td> <td style="font-size: 2em; padding: 5px;">50.0</td> <td style="padding: 5px;">Hz</td> </tr> <tr> <td style="padding: 5px;">OUTPUT</td> <td style="padding: 5px;">FWD</td> <td></td> </tr> </table>	REM	50.0	Hz	OUTPUT	REV		REM	50.0	Hz	OUTPUT	FWD	
REM	50.0	Hz											
OUTPUT	REV												
REM	50.0	Hz											
OUTPUT	FWD												
STOPPING THE MOTOR													
<p>Switch digital input DI1 off. The motor stops.</p> <p><u>Basic control panel</u>: Text FWD starts flashing slowly.</p> <p><u>Advanced HVAC control panel</u>: The arrow stops rotating.</p>	<table border="1" style="width: 100%; text-align: center;"> <tr> <td style="padding: 5px;">REM</td> <td style="font-size: 2em; padding: 5px;">0.0</td> <td style="padding: 5px;">Hz</td> </tr> <tr> <td style="padding: 5px;">OUTPUT</td> <td style="padding: 5px;">FWD</td> <td></td> </tr> </table>	REM	0.0	Hz	OUTPUT	FWD							
REM	0.0	Hz											
OUTPUT	FWD												





# 6. Actual signals and parameters in the short view

---

**Note:** When the control panel is in the short parameter view, that is when parameter [1611 PARAMETER VIEW](#) is set to 2 ([SHORT VIEW](#)), the control panel only shows a subset of all signals and parameters. These signals and parameters are described in this chapter.

---

To be able to view all actual signals and parameters, set parameter [1611 PARAMETER VIEW](#) to 3 ([LONG VIEW](#)). For the description of all actual signals and parameters, refer to chapter *Actual signals and parameters* in *ACS320 user's manual* (3AUA0000062599 [English]).

## Terms and abbreviations

Term	Definition
Actual signal	Signal measured or calculated by the drive. Can be monitored by the user. No user setting possible. Groups 01...04 contain actual signals.
Def	Parameter default value
E	Refers to types 03E- with European parametrization
FbEq	Fieldbus equivalent: The scaling between the value and the integer used in serial communication.
Parameter	A user-adjustable operation instruction of the drive. Groups 10...99 contain parameters. <b>Note:</b> Parameter selections are shown on the Basic control panel as integer values. Eg parameter 1001 EXT1 COMMANDS selection COMM is shown as value 10 (which is equal to the fieldbus equivalent FbEq).
U	Refers to types 03U- with US parametrization

## Fieldbus equivalent

**Example:** If parameter [2008 MAXIMUM FREQ](#) (see page [40](#)) is set from an external control system, an integer value of 1 corresponds to 0.1 Hz. All the read and sent values are limited to 16 bits (-32768...32767).

---

## Default values with different macros

When application macro is changed ([9902 APPLIC MACRO](#)), the software updates the parameter values to their default values. The table below shows the parameter default values for different macros. For other parameters, the default values are the same for all macros. See the parameter list starting on page [39](#) in this manual and chapter *Actual signals and parameters in ACS320 user's manual (3AUA0000062599 [English])*.

Index	Name/ Selection	HVAC DEFAULT	SUPPLY FAN	RETURN FAN	CLNG TWR FAN	CONDENSER	BOOSTER PUMP	PUMP ALTERNA	INT TIMER
<a href="#">9902</a>	<a href="#">APPLIC MACRO</a>	1 = HVAC DEFAULT	2 = SUPPLY FAN	3 = RETUR N FAN	4 = CLNG TWR FAN	5 = CONDENSER	6 = BOOSTER PUMP	7 = PUMP ALTERNA	8 = INT TIMER
1001	EXT1 COMMANDS	1 = DI1	1 = DI1	1 = DI1	1 = DI1	1 = DI1	1 = DI1	1 = DI1	11 = TIMER 1
1002	EXT2 COMMANDS	1 = DI1	1 = DI1	1 = DI1	1 = DI1	1 = DI1	1 = DI1	1 = DI1	1 = TIMER 1
1003	DIRECTION	1 = FORWARD	1 = FORWARD	1 = FORWARD	1 = FORWARD	1 = FORWARD	1 = FORWARD	1 = FORWARD	1 = FORWARD
1102	EXT1/EXT2 SEL	0 = EXT1	0 = EXT1	0 = EXT1	0 = EXT1	0 = EXT1	0 = EXT1	0 = EXT1	0 = EXT1
1103	REF1 SEL	1 = AI1	1 = AI1	1 = AI1	1 = AI1	1 = AI1	1 = AI1	1 = AI1	1 = AI1
1106	REF2 SEL	19 = PID1OUT	19 = PID1OUT	19 = PID1OUT	19 = PID1OUT	19 = PID1OUT	19 = PID1OUT	19 = PID1OUT	19 = PID1OUT
1201	CONST SPEED SEL	3 = DI3	3 = DI3	3 = DI3	3 = DI3	3 = DI3	3 = DI3	0 = NOT SEL	0 = NOT SEL
1304	MINIMUM AI2	20.0%	20.0%	20.0%	20.0%	20.0%	20.0%	20.0%	20.0%
<a href="#">1401</a>	<a href="#">RELAY OUTPUT 1</a>	1 = READY	7 = STARTED	7 = STARTED	1 = READY	1 = READY	1 = READY	31 = PFA	7 = STARTED
1601	RUN ENABLE	0 = NOT SEL	2 = DI2	0 = NOT SEL	0 = NOT SEL	0 = NOT SEL	0 = NOT SEL	0 = NOT SEL	2 = DI2
1608	START ENABLE 1	4 = DI4	4 = DI4	4 = DI4	4 = DI4	4 = DI4	4 = DI4	0 = NOT SEL	4 = DI4
1609	START ENABLE 2	0 = NOT SEL	5 = DI5	5 = DI5	0 = NOT SEL	0 = NOT SEL	0 = NOT SEL	0 = NOT SEL	5 = DI5
1805	DO SIGNAL	2 = RUN	2 = RUN	2 = RUN	2 = RUN	2 = RUN	2 = RUN	2 = RUN	2 = RUN
2007	MINIMUM FREQ	0.0 Hz	0.0 Hz	0.0 Hz	20.0Hz	0.0 Hz	0.0 Hz	0.0 Hz	0.0 Hz
<a href="#">2008</a>	<a href="#">MAXIMUM FREQ</a>	50.0 Hz	50.0 Hz	50.0 Hz	50.0 Hz	50.0 Hz	50.0 Hz	50.0 Hz	50.0 Hz
2101	START FUNCTION	6 = SCAN START	6 = SCAN START	6 = SCAN START	6 = SCAN START	6 = SCAN START	1 = AUTO	1 = AUTO	6 = SCAN START
2108	START INHIBIT	0 = OFF	0 = OFF	0 = OFF	0 = OFF	0 = OFF	0 = OFF	0 = OFF	0 = OFF
2201	ACC/DEC 1/2 SEL	0 = NOT SEL	0 = NOT SEL	0 = NOT SEL	0 = NOT SEL	0 = NOT SEL	0 = NOT SEL	0 = NOT SEL	0 = NOT SEL
<a href="#">2202</a>	<a href="#">ACCELER TIME 1</a>	30.0 s	30.0 s	30.0 s	30.0 s	30.0 s	10.0 s	10.0 s	30.0 s
<a href="#">2203</a>	<a href="#">DECELER TIME 1</a>	30.0 s	30.0 s	30.0 s	30.0 s	30.0 s	10.0 s	10.0 s	30.0 s
3019	COMM FAULT TIME	10.0 s	10.0 s	10.0 s	10.0 s	10.0 s	10.0 s	10.0 s	10.0 s
3415	SIGNAL 3 PARAM	AI 1	AI 1	AI 1	AI 1	AI 1	AI 1	AI 1	AI 1
3416	SIGNAL 3 MIN	-100.0%	-100.0%	-100.0%	-100.0%	-100.0%	-100.0%	-100.0%	-100.0%
3417	SIGNAL 3 MAX	100.0%	100.0%	100.0%	100.0%	100.0%	100.0%	100.0%	100.0%
3419	OUTPUT 3 DSP UNIT	mA	mA	mA	mA	mA	mA	mA	mA
3420	OUTPUT 3 MIN	0.0 mA	0.0 mA	0.0 mA	0.0 mA	0.0 mA	0.0 mA	0.0 mA	0.0 mA
3421	OUTPUT 3 MAX	20.0 mA	20.0 mA	20.0 mA	20.0 mA	20.0 mA	20.0 mA	20.0 mA	20.0 mA
3601	TIMERS ENABLE	0 = NOT SEL	0 = NOT SEL	0 = NOT SEL	0 = NOT SEL	0 = NOT SEL	0 = NOT SEL	0 = NOT SEL	1 = DI1

Index	Name/ Selection	HVAC DEFAULT	SUPPLY FAN	RETURN FAN	CLNG TWR FAN	CONDENSER	BOOSTER PUMP	PUMP ALTERNA	INT TIMER
3622	BOOST SEL	0 = NOT SEL	0 = NOT SEL	0 = NOT SEL	0 = NOT SEL	0 = NOT SEL	0 = NOT SEL	0 = NOT SEL	3 = DI3
3626	TIMER 1 SRC	0 = NOT SEL	0 = NOT SEL	0 = NOT SEL	0 = NOT SEL	0 = NOT SEL	0 = NOT SEL	0 = NOT SEL	23 = (P1+P2=P3+ B)
4001	GAIN	2.5	2.5	2.5	2.5	2.5	2.5	2.5	2.5
4002	INTEGRATION TIME	3.0 s	3.0 s	3.0 s	3.0 s	3.0 s	3.0 s	3.0 s	3.0 s
4005	ERROR VALUE INV	0 = NO	0 = NO	0 = NO	1 = YES	1 = YES	0 = NO	0 = NO	0 = NO
4010	SETPOINT SEL	0 = KEYPAD	0 = KEYPAD	0 = KEYPAD	0 = KEYPAD	0 = KEYPAD	0 = KEYPAD	0 = KEYPAD	0 = KEYPAD
4011	INTERNAL SETPNT	40.0%	40.0%	40.0%	40.0%	40.0%	40.0%	40.0%	40.0%
4027	PID 1 PARAM SET	0 = SET 1	0 = SET 1	0 = SET 1	0 = SET 1	0 = SET 1	0 = SET 1	0 = SET 1	0 = SET 1
4101	GAIN	2.5	2.5	2.5	2.5	2.5	2.5	2.5	2.5
4102	INTEGRATION TIME	3.0 s	3.0 s	3.0 s	3.0 s	60.0 s	3.0 s	3.0 s	3.0 s
4110	SETPOINT SEL	0 = KEYPAD	0 = KEYPAD	0 = KEYPAD	0 = KEYPAD	0 = KEYPAD	0 = KEYPAD	0 = KEYPAD	0 = KEYPAD
4111	INTERNAL SETPNT	40.0%	40.0%	40.0%	40.0%	40.0%	40.0%	40.0%	40.0%
5303	EFBBAUD RATE	9.6 kb/s	9.6 kb/s	9.6 kb/s	9.6 kb/s	9.6 kb/s	9.6 kb/s	9.6 kb/s	9.6 kb/s
5304	EFB PARITY	0 = 8 NONE 1	0 = 8 NONE 1	0 = 8 NONE 1	0 = 8 NONE 1	0 = 8 NONE 1	0 = 8 NONE 1	0 = 8 NONE 1	0 = 8 NONE 1
5305	EFB CTRL PROFILE	0 = ABB DRV LIM	0 = ABB DRV LIM	0 = ABB DRV LIM	0 = ABB DRV LIM	0 = ABB DRV LIM	0 = ABB DRV LIM	0 = ABB DRV LIM	0 = ABB DRV LIM
8109 1)	START FREQ 1	60.0 Hz	60.0 Hz	60.0 Hz	60.0 Hz	60.0 Hz	60.0 Hz	58.0 Hz	60.0 Hz
8110 1)	START FREQ 2	60.0 Hz	60.0 Hz	60.0 Hz	60.0 Hz	60.0 Hz	60.0 Hz	58.0 Hz	60.0 Hz
8111 1)	START FREQ 3	60.0 Hz	60.0 Hz	60.0 Hz	60.0 Hz	60.0 Hz	60.0 Hz	58.0 Hz	60.0 Hz
8116	AUX MOT STOP D	3.0 s	3.0 s	3.0 s	3.0 s	3.0 s	3.0 s	3.0 s	3.0 s
8118	AUTOCHNG INTERV	0.0 = NOT SEL	0.0 = NOT SEL	0.0 = NOT SEL	0.0 = NOT SEL	0.0 = NOT SEL	0.0 = NOT SEL	0.0 = NOT SEL	0.0 = NOT SEL
8123	PFA ENABLE	0 = NOT SEL	0 = NOT SEL	0 = NOT SEL	0 = NOT SEL	0 = NOT SEL	0 = NOT SEL	1 = ACTIVE	0 = NOT SEL



Index	Name/ Selection	INTIMERS	FLOATING PNT	DUAL SETPID	DL SP PID CS	E-BYPASS	HAND CONTROL	E-CLIPSE	AC500 MODBUS
4010	SETPOINT SEL	1 = AI1	0 = KEYPAD	19 = INTERNAL	19 = INTERNAL	0 = KEYPAD	1 = AI1	0 = KEYPAD	0 = KEYPAD
4011	INTERNAL SETPNT	40.0%	40.0%	50.0%	50.0%	40.0%	40.0%	40.0%	40.0%
4027	PID 1 PARAM SET	0 = SET 1	0 = SET 1	3 = DI3	3 = DI3	0 = SET 1	0 = SET 1	0 = SET 1	0 = SET 1
4101	GAIN	2.5	2.5	2.5	2.5	2.5	2.5	2.5	2.5
4102	INTEGRATION TIME	3.0 s	3.0 s	3.0 s	3.0 s	3.0 s	3.0 s	3.0 s	3.0 s
4110	SETPOINT SEL	1 = AI1	0 = KEYPAD	19 = INTERNAL	19 = INTERNAL	0 = KEYPAD	1 = AI1	0 = KEYPAD	0 = KEYPAD
4111	INTERNAL SETPNT	40.0%	40.0%	100.0%	100.0%	40.0%	40.0%	40.0%	40.0%
5303	EFBBAUD RATE	9.6 kb/s	9.6 kb/s	9.6 kb/s	9.6 kb/s	9.6 kb/s	9.6 kb/s	9.6 kb/s	9.6 kb/s
5304	EFB PARITY	0 = 8 NONE 1	0 = 8 NONE 1	0 = 8 NONE 1	0 = 8 NONE 1	0 = 8 NONE 1	0 = 8 NONE 1	2 = 8 EVEN 1	0 = 8 NONE 1
5305	EFB CTRL PROFILE	0 = ABB DRV LIM	0 = ABB DRV LIM	0 = ABB DRV LIM	0 = ABB DRV LIM	0 = ABB DRV LIM	0 = ABB DRV LIM	1 = DCU PROFILE	0 = ABB DRV LIM
8109 1)	START FREQ 1	60.0 Hz	60.0 Hz	60.0 Hz	60.0 Hz	60.0 Hz	60.0 Hz	60.0 Hz	60.0 Hz
8110 1)	START FREQ 2	60.0 Hz	60.0 Hz	60.0 Hz	60.0 Hz	60.0 Hz	60.0 Hz	60.0 Hz	60.0 Hz
8111 1)	START FREQ 3	60.0 Hz	60.0 Hz	60.0 Hz	60.0 Hz	60.0 Hz	60.0 Hz	60.0 Hz	60.0 Hz
8116	AUX MOT STOP D	3.0 s	3.0 s	3.0 s	3.0 s	3.0 s	3.0 s	3.0 s	3.0 s
8118	AUTOCHNG INTERV	0.0 = NOT SEL	0.0 = NOT SEL	0.0 = NOT SEL	0.0 = NOT SEL	0.0 = NOT SEL	0.0 = NOT SEL	0.0 = NOT SEL	0.0 = NOT SEL
8123	PFA ENABLE	0 = NOT SEL	0 = NOT SEL	0 = NOT SEL	0 = NOT SEL	0 = NOT SEL	0 = NOT SEL	0 = NOT SEL	0 = NOT SEL

1) The default value depends on the drive type. E: 50 Hz, U: 60 Hz.

## Actual signals in the short parameter view

Actual signals in the short parameter view			
No.	Name/Value	Description	FbEq
<b>04 FAULT HISTORY</b>		Fault history (read-only)	
0401	LAST FAULT	Code of the latest fault. See chapter <i>Fault tracing</i> in <i>ACS320 user's manual</i> (3AUA0000062599 [English]) for the codes. 0 = Fault history is clear (on panel display = NO RECORD).	1 = 1

## Parameters in the short parameter view

Parameters in the short parameter view									
No.	Name/Value	Description	Def/FbEq						
<b>11 REFERENCE SELECT</b>									
1105	REF1 MAX	Defines the maximum value for external reference REF1. Corresponds to the maximum setting of the used source signal.	E: 50.0 Hz U: 60.0 Hz						
	0.0...500.0 Hz	Maximum value in Hz. See the example for parameter 1104 REF1 MIN in <i>ACS320 user's manual</i> (3AUA0000062599 [English]).	1 = 0.1 Hz						
<b>12 CONSTANT SPEEDS</b>									
Constant speed (drive output frequency) selection and values. By default constant speed selection is made through digital input DI3. 1 = DI active, 0 = DI inactive.									
<table border="1"> <thead> <tr> <th>DI3</th> <th>Operation</th> </tr> </thead> <tbody> <tr> <td>0</td> <td>No constant speed</td> </tr> <tr> <td>1</td> <td>Speed defined by parameter <a href="#">1202</a> CONST SPEED 1</td> </tr> </tbody> </table>				DI3	Operation	0	No constant speed	1	Speed defined by parameter <a href="#">1202</a> CONST SPEED 1
DI3	Operation								
0	No constant speed								
1	Speed defined by parameter <a href="#">1202</a> CONST SPEED 1								
For more information, see chapter <i>Program features</i> , section <i>Constant speeds</i> in <i>ACS320 user's manual</i> (3AUA0000062599 [English]).									
1202	CONST SPEED 1	Defines constant drive output frequency 1.	E: 5.0 Hz U: 6.0 Hz						
	0.0...500.0 Hz	Output frequency in Hz.	1 = 0.1 Hz						
1203	CONST SPEED 2	Defines constant drive output frequency 2.	E: 10.0 Hz U: 12.0 Hz						
	0.0...500.0 Hz	Output frequency in Hz.	1 = 0.1 Hz						
1204	CONST SPEED 3	Defines constant drive output frequency 3.	E: 15.0 Hz U: 18.0 Hz						
	0.0...500.0 Hz	Output frequency in Hz.	1 = 0.1 Hz						
<b>13 ANALOG INPUTS</b>									
Analog input signal processing									
1301	MINIMUM AI1	Defines the minimum %-value that corresponds to minimum mA(V) signal for analog input AI1. When used as a reference, the value corresponds to the reference minimum setting. 0...20 mA $\hat{=}$ 0...100% 4...20 mA $\hat{=}$ 20...100% -10...10 mA $\hat{=}$ -50...50% <b>Example:</b> If AI1 is selected as the source for external reference REF1, this value corresponds to the value of parameter 1104 REF1 MIN. <b>Note:</b> <i>MINIMUM AI1</i> value must not exceed MAXIMUM AI value.	20.0%						
	-100.0... 100.0%	Value as a percentage of the full signal range. <b>Example:</b> If the minimum value for analog input is 4 mA, the percent value for 0...20 mA range is: (4 mA / 20 mA) · 100% = 20%	1 = 0.1%						

Parameters in the short parameter view			
No.	Name/Value	Description	Def/FbEq
<b>14 RELAY OUTPUTS</b>		Status information indicated through relay output, and relay operating delays. For more information, see chapter <i>Actual signals and parameters</i> in <i>ACS320 user's manual</i> (3AUA0000062599 [English]).	
1401	RELAY OUTPUT 1	Selects a drive status indicated through relay output RO 1. The relay energizes when the status meets the setting.	<i>READY</i>
	NOT SEL	Not used	0
	READY	Ready to function: Run enable signal present, no fault exists, supply voltage is within range, and emergency stop command is not On.	1
	RUN	Running: Energize relay when power is applied.	2
	FAULT(-1)	Inverted fault. Energize relay when power is applied. De-energizes when a fault occurs.	3
<b>16 SYSTEM CONTROLS</b>		Parameter view, Run enable, parameter lock etc.	
1611	PARAMETER VIEW	Selects the parameter view, i.e, which parameters are shown on the control panel.	<i>SHORT VIEW</i>
	FLASHDROP	Shows the FlashDrop parameter list. Does not include the short parameter list. Parameters which are hidden by the FlashDrop device are not visible. FlashDrop parameter values are activated by setting parameter <i>9902 APPLIC MACRO</i> to 31 (LOAD FD SET).	1
	SHORT VIEW	Shows only those signals and parameters that are listed in this table.	2
	LONG VIEW	Shows all signals and parameters. See chapter <i>Actual signals and parameters</i> in <i>ACS320 user's manual</i> (3AUA0000062599 [English]).	3
<b>20 LIMITS</b>		Drive operation limits	
2008	MAXIMUM FREQ	Defines the maximum limit for the drive output frequency.	E: 50.0 Hz U: 60.0 Hz
	0.0...500.0 Hz	Maximum frequency	1 = 0.1 Hz
<b>21 START/STOP</b>		Start and stop modes of the motor	
2102	STOP FUNCTION	Selects the motor stop function.	<i>COAST</i>
	COAST	Stop by cutting off the motor power supply. The motor coasts to stop.	1
	RAMP	Stop along a ramp. See parameter group <a href="#">22 ACCEL/DECEL</a> .	2



Parameters in the short parameter view			
No.	Name/Value	Description	Def/FbEq
<b>22 ACCEL/DECEL</b>		Acceleration and deceleration times	
2202	ACCELER TIME 1	<p>Defines the acceleration time 1, i.e., the time required for the speed to change from zero to the speed defined by parameter <a href="#">2008 MAXIMUM FREQ.</a></p> <ul style="list-style-type: none"> <li>• If the speed reference increases faster than the set acceleration rate, the motor speed will follow the acceleration rate.</li> <li>• If the speed reference increases slower than the set acceleration rate, the motor speed will follow the reference signal.</li> <li>• If the acceleration time is set too short, the drive will automatically prolong the acceleration in order not to exceed the drive operating limits.</li> </ul> <p>Actual acceleration time depends on parameter 2204 RAMP SHAPE 1 setting.</p>	30.0 s
	0.0...1800.0 s	Time	1 = 0.1 s
2203	DECELER TIME 1	<p>Defines the deceleration time 1, i.e., the time required for the speed to change from the value defined by parameter <a href="#">2008 MAXIMUM FREQ.</a> to zero.</p> <ul style="list-style-type: none"> <li>• If the speed reference decreases slower than the set deceleration rate, the motor speed will follow the reference signal.</li> <li>• If the reference changes faster than the set deceleration rate, the motor speed will follow the deceleration rate.</li> <li>• If the deceleration time is set too short, the drive will automatically prolong the deceleration in order not to exceed drive operating limits.</li> </ul> <p>If a short deceleration time is needed for a high inertia application, note that the ACS320 cannot be equipped with a brake resistor.</p> <p>Actual deceleration time depends on parameter 2204 RAMP SHAPE 1 setting.</p>	30.0 s
	0.0...1800.0 s	Time	1 = 0.1 s
<b>53 EFB PROTOCOL</b>		Embedded fieldbus link settings.	
5301	EFB PROTOCOL ID	<p>Contains the identification and program revision of the protocol.</p> <p><b>Note:</b> You can reset this parameter only with parameter <a href="#">9802 COMM PROT SEL.</a></p> <p>Format XXYY hex, where XX = protocol ID and YY = program revision of the protocol.</p>	0000 hex
	0000...FFFF hex	Protocol identification and program revision.	1 = 1 hex
5302	EFB STATION ID	Defines the address of the device. Two units with the same address are not allowed on-line.	1
	0...65535	Device address.	1 = 1
5303	EFB BAUD RATE	Defines the transfer rate of the link.	9.6 kbit/s
	1.2...76.8 kbits/s	Transfer rate of the link.	-

## 42 Actual signals and parameters in the short view

Parameters in the short parameter view			
No.	Name/Value	Description	Def/FbEq
5304	EFB PARITY	Defines the use of parity and stop bit(s) and the data length. The same setting must be used in all on-line stations.	8 NONE 1
	8 NONE 1	8 data bits, no parity, one stop bit.	0
	8 NONE 2	8 data bits, no parity two stop bits.	1
	8 EVEN 1	8 data bits, even parity, one stop bit.	2
	8 ODD 1	8 data bits, odd parity, one stop bit.	3
5305	EFB CTRL PROFILE	Selects the communication profile.	ABB DRV LIM
	ABB DRV LIM	Operation of Control/Status words conforms to ABB Drives Profile.	0
	DCU PROFILE	Operation of Control/Status words conforms to 32-bit DCU profile.	1
	ABB DRV FULL	Operation of Control/Status words conforms to ABB Drives Profile.	2
5306	EFB OK MESSAGES	Number of valid messages received by the drive. During normal operation, this number increases constantly.	0
	0...65535	Valid messages received by the drive.	1 = 1
5307	EFB CRC ERRORS	Number of messages with an CRC (cyclic redundancy check) error received by the drive. If the number is high, check CRC calculation for possible errors. <b>Note:</b> High electromagnetic noise levels generate errors.	0
	0...65535	CRC error received by the drive.	1 = 1
5308	EFB UART ERRORS	Number of messages with a character error received by the drive.	0
	0...65535	Character errors received by the drive.	1 = 1
5309	EFB STATUS	Status of the EFB protocol.	IDLE
	IDLE	EFB protocol is configured, but not receiving any messages.	0
	EXECUT INIT	EFB protocol is initializing.	1
	TIME OUT	A time-out has occurred in the communication between the network master and the EFB protocol.	2
	CONFIG ERROR	EFB protocol has a configuration error.	3
	OFF LINE	EFB protocol is receiving messages that are NOT addressed to this drive.	4
	ON-LINE	EFB protocol is receiving messages that are addressed to this drive.	5
	RESET	EFB protocol is performing a hardware reset.	6
	LISTEN ONLY	EFB protocol is in listen-only mode.	7
5310	EFB PAR 10	Selects an actual value to be mapped to Modbus register 40005.	0
5311	EFB PAR 11	Selects an actual value to be mapped to Modbus register 40006.	0
5312	EFB PAR 12	Selects an actual value to be mapped to Modbus register 40007.	0
5313	EFB PAR 13	Selects an actual value to be mapped to Modbus register 40008.	0

Parameters in the short parameter view			
No.	Name/Value	Description	Def/FbEq
5314	EFB PAR 14	Selects an actual value to be mapped to Modbus register 40009.	0
5315	EFB PAR 15	Selects an actual value to be mapped to Modbus register 40010.	0
5316	EFB PAR 16	Selects an actual value to be mapped to Modbus register 40011.	0
5317	EFB PAR 17	Selects an actual value to be mapped to Modbus register 40012.	0
5318	EFB PAR 18	For Modbus: Sets an additional delay before the drive begins transmitting response to the master request.	0
5319	EFB PAR 19	ABB drives profile (ABB DRV LIM or ABB DRV FULL) Control word. Read only copy of the Fieldbus Control word.	0000 hex
5320	EFB PAR 20	ABB drives profile (ABB DRV LIM or ABB DRV FULL) Status word. Read only copy of the Fieldbus Status word.	0000 hex
<b>98 OPTIONS</b>		External serial communication activation.	
9802	COMM PROT SEL	Activates the external serial communication and selects the interface.	NOT SEL
	NOT SEL	No communication protocol selected	0
	STD MODBUS	The drive communicates with Modbus through the EIA-485 channel (X1-communication, terminal).	1
	N2	Enables fieldbus communication with the drive using Metasys N2 protocol through the EIA-485 serial link (X1-communications terminal).	2
	FLN	Enables fieldbus communication with the drive using FLN protocol through the EIA-485 serial link (X1-communications terminal).	3
	BACNET	Enables fieldbus communication with the drive using BACnet protocol through the EIA-485 serial link (X1-communication terminal).	5
	MODBUS RS232	Enables fieldbus communication with the drive using the Modbus protocol through the RS232 serial link.	10
	0...65535	CRC error received by the drive.	1 = 1
<b>99 START-UP DATA</b>		Language selection. Definition of motor set-up data.	
9901	LANGUAGE	Selects the display language used on the Advanced HVAC control panel.	<i>ENGLISH</i>
	ENGLISH	British English	0
	ENGLISH (AM)	American English	1
	DEUTSCH	German	2
	ITALIANO	Italian	3
	ESPAÑOL	Spanish	4
	PORTUGUES	Portuguese	5
	NEDERLANDS	Dutch	6
	FRANÇAIS	French	7
	DANSK	Danish	8
	SUOMI	Finnish	9
	SVENSKA	Swedish	10

Parameters in the short parameter view			
No.	Name/Value	Description	Def/FbEq
	RUSSKI	Russian	11
	POLSKI	Polish	12
	TÜRKÇE	Turkish	13
	CZECH	Czech	14
	MAGYAR	Hungarian	15
	ELLINIKA	Greek	16
	CHINESE	Chinese	17
	KOREAN	Korean	18
	JAPANESE	Japanese	19
9902	APPLIC MACRO	Selects the application macro. See chapter <i>Application macros</i> in <i>ACS320 user's manual</i> (3AUA0000062599 [English]).	<i>HVAC DEFAULT</i>
	HVAC DEFAULT	This macro provides the factory default parameter settings for the ACS320.	1
	SUPPLY FAN	For supply fan applications where the supply fan brings fresh air in.	2
	RETURN FAN	For return fan applications where the return fan removes air.	3
	CLNG TWR FAN	For cooling tower fan applications.	4
	CONDENSER	For condenser and liquid cooler applications.	5
	BOOSTER PUMP	For booster pump applications.	6
	PUMP ALTERNA	For pump and fan alternation (PFA) applications.	7
	INT TIMER	For applications where a built-in timer starts and stops the motor.	8
	INT TIMER CS	For applications such as a timed powered roof ventilator (PRV) which alternates between two constant speeds (constant speed 1 and 2) based on a built-in timer.	9
	FLOATING PNT	For applications where speed reference needs to be controlled through digital inputs (DI4 & DI5). By activating digital input 4, the speed reference increases, by activating digital input 5, the speed reference decreases. If both digital inputs are active or inactive, the reference does not change.	10
	DUAL SETPID	For dual setpoint PID applications, where activating digital input 3 (DI3) changes the process PID controller's setpoint to another value.	11
	DL SP PID CS	For applications with 2 constant speeds, active PID and PID alternating between two setpoints using digital inputs.	12
	E-BYPASS	This macro provides the equivalent ACH550 E-Bypass default parameter settings for the ACS320. (The ACS320 is not physically compatible with the E-Bypass.)	13
	HAND CONTROL	For drive control using only the control panel with no automated control.	14
	E-CLIPSE	This macro provides the equivalent ACH550 E-Clipse Bypass default parameter settings for the ACS320. (The ACS320 is not compatible with the E-Clipse Bypass.)	15

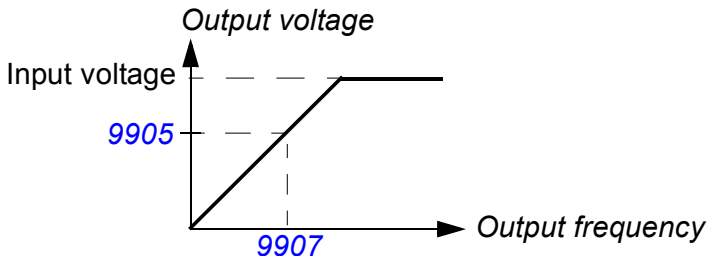
Parameters in the short parameter view			
No.	Name/Value	Description	Def/FbEq
	AC500 MODBUS	This macro configures the drive communication and control parameters.	21
9905	MOTOR NOM VOLT	<p>Defines the nominal motor voltage. Must be equal to the value on the motor rating plate. The drive cannot supply the motor with a voltage greater than the input power voltage. Note that the output voltage is not limited by the nominal motor voltage but increased linearly up to the value of the input voltage.</p>  <p><b>WARNING!</b> Never connect a motor to a drive which is connected to power line with voltage level higher than the rated motor voltage.</p> <p>The stress on the motor insulations depends on the drive supply voltage. This applies also when the motor voltage rating is lower than the rating of the drive and the supply voltage of the drive. The RMS voltage can be limited to motor nominal voltage by setting the maximum frequency of the drive (parameter <a href="#">2008</a>) to the motor nominal frequency.</p>	200 V units: 230 V 400 V E units: 400 V 400 V U units: 460 V
	115...345 V (200 V units) 200...600 V (400 V E units) 230...690 V (400 V U units)	Voltage. <b>Note:</b> The stress on the motor insulations is always dependent on the drive supply voltage. This also applies to the case where the motor voltage rating is lower than the rating of the drive and the supply of the drive.	1 = 1 V
9906	MOTOR NOM CURR	Defines the nominal motor current. Must be equal to the value on the motor rating plate.	$I_{2N}$
	0.2...2.0 · $I_{2N}$	Current	1 = 0.1 A
9907	MOTOR NOM FREQ	Defines the nominal motor frequency, ie the frequency at which the output voltage equals the nominal motor voltage: Field weakening point = Nom. frequency · Supply voltage / Motor nom. voltage	E: 50.0 Hz U: 60.0 Hz
	10.0...500.0 Hz	Frequency	1 = 0.1 Hz
9908	MOTOR NOM SPEED	Defines the nominal motor speed. Must be equal to the value on the motor rating plate.	Type dependent
	50...18000 rpm	Speed	1 = 1 rpm
9909	MOTOR NOM POWER	Defines the nominal motor power. Must equal the value on the motor rating plate.	$P_N$
	0.2... 3.0 · $P_N$ kW	Power	1 = 0.1 kW / 0.1 hp



# 7. Technical data

## Ratings

**Note:** When choke is not used, input current is effected by supply network and impedance.

Use the table in [Fuses and alternate short-circuit protection](#) (page 50) to correctly size the input cabling as well as input fuses or MMP for branch circuit protection. Sizing will be determined by the actual input current which is dependent on the input line voltage and the input choke selection and rated motor current. If motor rated current is below  $I_{2N}$ ,  $I_{1N}$  is reduced relatively.

Type code	Input				Output					Frame size
	without choke or reactor		with choke or 5% reactor		$I_{LD}^{2)}$	$I_{2N}$	$I_{2max}^{3)}$	$P_N$		
ACS320-	$I_{1N}$	$I_{1N}$ (480 V)	$I_{1N}$	$I_{1N}$ (480 V)						A
x = E/U <sup>1)</sup>	A	A	A	A	A	A	A	kW	hp	
<b>1-phase supply voltage 200...240 V units</b> (Confirm output ratings meet motor requirements)										
01x-02A4-2	6.1	-	4.5	-	2.3	2.4	4.0	0.37	0.5	R0
01x-04A7-2	11.4	-	8.1	-	4.5	4.7	7.9	0.75	1	R1
01x-06A7-2	16.1	-	11.0	-	6.5	6.7	11.4	1.1	1.5	R1
01x-07A5-2	16.8	-	12.0	-	7.2	7.5	12.6	1.5	2	R2
01x-09A8-2	21.0	-	15.0	-	9.4	9.8	16.5	2.2	3	R2
<b>3-phase supply voltage 200...240 V units</b>										
03x-02A6-2	4.7	-	2.6	-	2.4	2.6	4.2	0.37	0.5	R0
03x-03A9-2	6.7	-	3.9	-	3.5	3.9	6.1	0.55	0.75	R0
03x-05A2-2	8.4	-	5.2	-	4.7	5.2	8.2	0.75	1	R1
03x-07A4-2	13.0	-	7.4	-	6.7	7.4	11.7	1.1	1.5	R1
03x-08A3-2	13.2	-	8.3	-	7.5	8.3	13.1	1.5	2	R1
03x-10A8-2	15.7	-	10.8	-	9.8	10.8	17.2	2.2	3	R2
03x-14A6-2	23.9	-	14.6	-	13.3	14.6	23.3	3	3	R2
03x-19A4-2	27.3	-	19.4	-	17.6	19.4	30.8	4	5	R2
03x-26A8-2	45.0	-	26.8	-	24.4	26.8	42.7	5.5	7.5	R3
03x-34A1-2	55.0	-	34.1	-	31.0	34.1	54.3	7.5	10	R4
03x-50A8-2	76.0	-	50.8	-	46.2	50.8	80.9	11.0	15	R4
<b>3-phase supply voltage 380...480 V units</b>										
03x-01A2-4	2.4	2.0	1.3	1.1	1.1	1.2	2.1	0.37	0.5	R0
03x-01A9-4	4.0	3.3	2.0	1.7	1.7	1.9	3.3	0.55	0.75	R0
03x-02A4-4	4.5	3.8	2.5	2.1	2.2	2.4	4.2	0.75	1.0	R1
03x-03A3-4	6.6	5.5	3.5	2.9	3.0	3.3	5.8	1.1	1.5	R1

Type code	Input				Output					Frame size
	without choke or reactor		with choke or 5% reactor		$I_{LD}^{2)}$	$I_{2N}$	$I_{2max}^{3)}$	$P_N$		
ACS320-	$I_{1N}$	$I_{1N}$ (480 V)	$I_{1N}$	$I_{1N}$ (480 V)						A
x = E/U <sup>1)</sup>	A	A	A	A	A	A	A	kW	hp	
03x-04A1-4	7.6	6.3	3.8	3.2	3.7	4.1	7.2	1.5	2.0	R1
03x-05A6-4	10.6	8.8	5.3	4.4	5.1	5.6	9.8	2.2	3.0	R1
03x-07A3-4	12.8	10.7	6.8	5.7	6.6	7.3	12.8	3.0	3.0	R1
03x-08A8-4	15.0	12.5	8.6	7.2	8.0	8.8	15.4	4.0	5.0	R1
03x-12A5-4	20.7	17.2	12.3	10.3	11.4	12.5	21.9	5.5	7.5	R3
03x-15A6-4	24.3	20.3	13.0	10.8	14.2	15.6	27.3	7.5	10.0	R3
03x-23A1-4	34.0	28.3	20.0	16.7	21.0	23.1	40.4	11.0	15.0	R3
03x-31A0-4	57.2	47.7	27.0	22.5	28.2	31.0	54.3	15.0	20.0	R4
03x-38A0-4	67.1	55.9	34.9	29.1	34.5	38.0	66.5	18.5	25.0	R4
03x-44A0-4	73.7	61.4	41.6	34.7	40.0	44.0	77.0	22.0	30.0	R4

<sup>1)</sup> E = EMC filter connected (metal EMC filter screw installed),  
U = EMC filter disconnected (plastic EMC filter screw installed), default.

<sup>2)</sup> Overloadability for one minute every ten minutes.

<sup>3)</sup> Instantaneous peak current for two seconds every ten minutes

00578903.xls J

## Definitions

Input

$I_{1N}$  continuous rms input current (for dimensioning cables and fuses) with  $I_{2N}$  motor current at rated speed and power. If motor rated current is below  $I_{2N}$ ,  $I_{1N}$  is reduced relatively.

$I_{1N}$  (480 V) continuous rms input current (for dimensioning cables, fuses, and MMPs) for drives with 480 V with  $I_{2N}$  motor current at rated speed and power. If motor rated current is below  $I_{2N}$ ,  $I_{1N}$  is reduced relatively.

Output

$I_{LD}$  continuous output current at max ambient temperature of +50 °C (122 °F). 10% overloadability for one minute every ten minutes.

$I_{2N}$  maximum continuous output current at ambient temperature of +40 °C (104 °F). No overloadability, derating 1% for every additional 1 °C up to 50 °C (122 °F).

$I_{2max}$  maximum instantaneous output current. Available for two seconds every ten minutes at start-up, or as long as allowed by the drive temperature.

$P_N$  typical motor power. The kilowatt ratings apply to most IEC 4-pole motors. The horsepower ratings apply to most NEMA 4-pole motors. Drive should be selected based on motor current relative to loading capacity ( $I_{LD}$  or  $I_{2N}$ ).

**R0...R4** ACS320 is manufactured in frame sizes R0...R4. Some instructions and other information that only concern certain frame sizes are marked with the symbol of the frame size (R0...R4).



## ■ Sizing

Drive sizing is based on the rated motor current and power. To achieve the rated motor power given in the table, the rated current of the drive must be higher than or equal to the rated motor current. The rated power of the drive must also be higher than or equal to compared to the rated motor power. The power ratings are the same regardless of the supply voltage within one voltage range.

In multimotor systems, the drive output current rating  $I_{LD}$  must be equal to or greater than the calculated sum of the input currents of all motors.

### Note:

- The maximum allowed motor shaft power is limited to  $1.5 \cdot P_N$ . If the limit exceeds, motor torque and current are automatically restricted. The function protects the input bridge of the drive against overload.
- The ratings apply at ambient temperature of 40 °C (104 °F) for  $I_{2N}$  and 50 °C (122 °F) for  $I_{LD}$ .

## ■ Derating

For information on derating, see chapter *Technical data*, section *Derating* in *ACS320 user's manual* (3AUA0000062599 [English]).

---

## Fuses and alternate short-circuit protection

### ■ Fuses

The rated fuse currents given in the table are the maximums for the mentioned fuse types. If smaller fuse ratings are used, check that the fuse rms current rating is larger than the rated  $I_{1N}$  current given in the [Ratings](#) table on page 47. If 150% of output power is needed, multiply current  $I_{1N}$  by 1.5.

**Check that the operating time of the fuse is below 0.5 seconds.** The operating time depends on the fuse type, the supply network impedance as well as the cross-sectional area, material and length of the supply cable. In case the 0.5 seconds operating time is exceeded with the gG or T fuses, ultra rapid (aR) fuses reduces in most cases the operating time to an acceptable level.

#### Note:

- Do not use larger fuses when the input power cable is selected according to this table.
- Choose the correct fuse size according to the actual input current which depends on the input line voltage and the input choke selection.
- You can use other fuse types if they meet the current rating of the fuse in the table and also if the melting curve of the other fuses does not exceed the melting curve of the fuse in the table.

### ■ Alternate short-circuit protection

In accordance with the National Electrical Code (NEC), the following ABB type E manual motor protectors can be used as an alternate to the recommended fuses as a means of branch circuit protection:

- MS132-x.x and S1-M3-25
- MS495-xx or MS495-xxE and SK4-11 & DX49
- MS165-xx.

When the correct ABB type E manual motor protector is selected from the table and used for branch circuit protection, the drive is suitable for use in a circuit capable of delivering not more than 65 kA RMS symmetrical amperes at the drive maximum rated voltage. See the appropriate ratings in the following table.

IP20 open type and IP21 UL type 1 ACS320 can use ABB type E manual motor protectors for branch circuit protection. See the MMP rating table for the minimum enclosure volume of IP20 open type ACS320 mounted in an enclosure.

## Fuses and MMPs

Type	Fuses			MMPs				
ACS320-	gG	UL Class T or CC (600 V)		Frame	$I_{1N}$	MMP Type E	Min. Encl. Vol. <sup>4)</sup>	
x = E/U <sup>1)</sup>	A	min A <sup>2)</sup>	max A		A		dm <sup>3</sup>	in <sup>3</sup>
<b>1-phase U<sub>N</sub> = 200...240 V (200, 208, 220, 230, 240 V)</b>								
01x-02A4-2	10	6	10	R0	6.1	MS132-6.3 & S1-M3-25	18.9	1152
01x-04A7-2	16	10	20	R1	11.4	MS165-16 <sup>3)</sup>	18.9	1152
01x-06A7-2	16/20*	15	25	R1	16.1	MS165-20 <sup>3)</sup>	18.9	1152
01x-07A5-2	20/25*	15	30	R2	16.8	MS165-20 <sup>3)</sup>	-	-
01x-09A8-2	25/35*	15	35	R2	21.0	MS165-25 <sup>3)</sup>	-	-
<b>3-phase U<sub>N</sub> = 200...240 V (200, 208, 220, 230, 240 V)</b>								
03x-02A6-2	10	3	10	R0	4.7	MS132-6.3 & S1-M3-25	18.9	1152
03x-03A9-2	10	6	10	R0	6.7	MS132-10 & S1-M3-25	18.9	1152
03x-05A2-2	10	6	15	R1	8.4	MS132-10 & S1-M3-25	18.9	1152
03x-07A4-2	16	10	15	R1	13.0	MS165-16 <sup>3)</sup>	18.9	1152
03x-08A3-2	16	10	15	R1	13.2	MS165-16 <sup>3)</sup>	18.9	1152
03x-10A8-2	16	15	20	R2	15.7	MS165-20 <sup>3)</sup>	-	-
03x-14A6-2	25	15	30	R2	23.9	MS165-25 <sup>3)</sup>	-	-
03x-19A4-2	25	20	35	R2	27.3	MS165-32 <sup>3)</sup>	-	-
03x-26A8-2	63	30	60	R3	45.0	MS165-54 <sup>3)</sup>	-	-
03x-34A1-2	80	35	80	R4	55.0	MS165-65 <sup>3)</sup>	-	-
03x-50A8-2	100	50	100	R4	76.0	MS495-90 & SK4 & DX49	-	-
<b>3-phase U<sub>N</sub> = 380... 480 V (380, 400, 415 V) (MMP ratings for 480Y/277V only)</b>								
03x-01A2-4	10	2	10	R0	2.2	MS132-2.5 & S1-M3-25	18.9	1152
03x-01A9-4	10	2	10	R0	3.6	MS132-4.0 & S1-M3-25	18.9	1152
03x-02A4-4	10	3	10	R1	4.1	MS132-6.3 & S1-M3-25	18.9	1152
03x-03A3-4	10	3	10	R1	6.0	MS132-6.3 & S1-M3-25	18.9	1152
03x-04A1-4	16	6	15	R1	6.9	MS132-10 & S1-M3-25	18.9	1152
03x-05A6-4	16	6	15	R1	9.6	MS132-10 & S1-M3-25	18.9	1152
03x-07A3-4	16	6	20	R1	11.6	MS165-16 <sup>3)</sup>	18.9	1152
03x-08A8-4	20	10	25	R1	13.6	MS165-16 <sup>3)</sup>	18.9	1152
03x-12A5-4	25	10	30	R3	18.8	MS165-20 <sup>3)</sup>	-	-
03x-15A6-4	35	15	35	R3	22.1	MS165-25 <sup>3)</sup>	-	-
03x-23A1-4	50	20	50	R3	30.9	MS165-42 <sup>3)</sup>	-	-
03x-31A0-4	80	25	80	R4	52.0	MS165-65 <sup>3)</sup>	-	-
03x-38A0-4	100	30	100	R4	61.0	MS165-65 <sup>3)</sup>	-	-
03x-44A0-4	100	35	100	R4	67.0	MS495-75 & SK4-11 & DX49	-	-
<b>3-phase U<sub>N</sub> = 380... 480 V (440, 460, 480 V) (MMP ratings for 480Y/277V only)</b>								
03x-01A2-4	10	2	10	R0	1.8	MS132-2.5 & S1-M3-25	18.9	1152
03x-01A9-4	10	2	10	R0	3.0	MS132-4.0 & S1-M3-25	18.9	1152
03x-02A4-4	10	3	10	R1	3.4	MS132-6.3 & S1-M3-25	18.9	1152
03x-03A3-4	10	3	10	R1	5.0	MS132-6.3 & S1-M3-25	18.9	1152
03x-04A1-4	16	6	15	R1	5.8	MS132-10 & S1-M3-25	18.9	1152
03x-05A6-4	16	6	15	R1	8.0	MS132-10 & S1-M3-25	18.9	1152
03x-07A3-4	16	6	20	R1	9.7	MS132-10 & S1-M3-25	18.9	1152
03x-08A8-4	20	10	25	R1	11.0	MS165-16 <sup>3)</sup>	18.9	1152
03x-12A5-4	25	10	30	R3	16.0	MS165-20 <sup>3)</sup>	-	-

Type	Fuses			MMPs				
	gG	UL Class T or CC (600 V)		Frame	I <sub>1N</sub>	MMP Type E	Min. Encl. Vol. <sup>4)</sup>	
x = E/U <sup>1)</sup>	A	min A <sup>2)</sup>	max A				A	dm <sup>3</sup>
03x-15A6-4	35	15	35	R3	18.0	MS165-20 <sup>3)</sup>	-	-
03x-23A1-4	50	20	50	R3	26.0	MS165-32 <sup>3)</sup>	-	-
03x-31A0-4	80	25	80	R4	43.0	MS165-54 <sup>3)</sup>	-	-
03x-38A0-4	100	30	100	R4	51.0	MS165-65 <sup>3)</sup>	-	-
03x-44A0-4	100	35	100	R4	56.0	MS165-65 <sup>3)</sup>	-	-

00578903.xls.J

<sup>1)</sup> E = EMC filter connected (metal EMC filter screw installed),

U = EMC filter disconnected (plastic EMC filter screw installed), U.S parameterization.

<sup>2)</sup> minimum fuse size can be used with input choke according to table in Rating section

<sup>3)</sup> Trip class 10; integral trip indication; does not require additional line-side feeder terminal.

<sup>4)</sup> For all drives, the enclosure must be sized to accommodate the specific thermal considerations of the applications as well as provide free space for cooling. See *ACS320 user's manual*, chapter *Technical data*, section *Free space requirements*.

For UL only: The minimum enclosure volume is specified in the UL listing for drive frames R0 and R1 when applied with the ABB type E MMP shown in the table. ACS320 drives are intended to be mounted in an

## UL marking

See the type designation label for the valid markings of your drive.

The UL mark is attached to the drive to verify that it meets UL requirements.

### ■ UL checklist

See the instructions for electrical installation in the sections in this manual or in the *ACS320 user's manual* (3AUA0000062599 [English]0 specified below.

**Input power connection** – See *ACS320 user's manual*, chapter *Technical data*, section *Electrical power network specification*.

**Disconnecting device (disconnecting means)** – See *ACS320 user's manual*, chapter *Planning the electrical installation*, section *Selecting the supply disconnecting device (disconnecting means)*.

**Ambient conditions** – The drives are to be used in a heated indoor controlled environment. See *ACS320 user's manual*, chapter *Technical data*, section *Ambient conditions* for specific limits.

**Input cable fuses** – For installation in the United States, branch circuit protection must be provided in accordance with the National Electrical Code (NEC) and any applicable local codes. To fulfill this requirement, use the UL classified fuses given in section *Fuses and MMPs* on page 51.

For installation in Canada, branch circuit protection must be provided in accordance with Canadian Electrical Code and any applicable provincial codes. To fulfill this requirement, use the UL classified fuses given in section *Fuses and MMPs* on page 51.

**Power cable selection** – See *ACS320 user's manual*, chapter *Planning the electrical installation*, section *Selecting the power cables*.

**Power cable connections** – For the connection diagram and tightening torques, see section *Connecting the power cables* on page 19.

**Overload protection** – The drive provides overload protection in accordance with the National Electrical Code (US).

---









## Further information

### Product and service inquiries

Address any inquiries about the product to your local ABB representative, quoting the type designation and serial number of the unit in question. A listing of ABB sales, support and service contacts can be found by navigating to [www.abb.com/searchchannels](http://www.abb.com/searchchannels).

### Product training

For information on ABB product training, navigate to [new.abb.com/service/training](http://new.abb.com/service/training).

### Providing feedback on ABB Drives manuals

Your comments on our manuals are welcome. Navigate to [new.abb.com/drives/manuals-feedback-form](http://new.abb.com/drives/manuals-feedback-form).

### Document library on the Internet

You can find manuals and other product documents in PDF format on the Internet at [www.abb.com/drives/documents](http://www.abb.com/drives/documents).