



AM-140-A

AM-160-A

**Precision DMM with TRMS &
PC Connection**

Users Manual

- Mode d'emploi
- Bedienungshandbuch
- Manual d'Uso
- Manual de uso



AM-140-A

AM-160-A

Precision DMM with TRMS & PC Connection

Users Manual

English

Limited Warranty and Limitation of Liability

Your Amprobe product will be free from defects in material and workmanship for 1 year from the date of purchase. This warranty does not cover fuses, disposable batteries or damage from accident, neglect, misuse, alteration, contamination, or abnormal conditions of operation or handling. Resellers are not authorized to extend any other warranty on Amprobe's behalf. To obtain service during the warranty period, return the product with proof of purchase to an authorized Amprobe Test Tools Service Center or to an Amprobe dealer or distributor. See Repair Section for details. **THIS WARRANTY IS YOUR ONLY REMEDY. ALL OTHER WARRANTIES - WHETHER EXPRESS, IMPLIED OR STATUTORY - INCLUDING IMPLIED WARRANTIES OF FITNESS FOR A PARTICULAR PURPOSE OR MERCHANTABILITY, ARE HEREBY DISCLAIMED. MANUFACTURER SHALL NOT BE LIABLE FOR ANY SPECIAL, INDIRECT, INCIDENTAL OR CONSEQUENTIAL DAMAGES OR LOSSES, ARISING FROM ANY CAUSE OR THEORY.** Since some states or countries do not allow the exclusion or limitation of an implied warranty or of incidental or consequential damages, this limitation of liability may not apply to you.

Repair

All test tools returned for warranty or non-warranty repair or for calibration should be accompanied by the following: your name, company's name, address, telephone number, and proof of purchase. Additionally, please include a brief description of the problem or the service requested and include the test leads with the meter. Non-warranty repair or replacement charges should be remitted in the form of a check, a money order, credit card with expiration date, or a purchase order made payable to Amprobe® Test Tools.

In-Warranty Repairs and Replacement – All Countries

Please read the warranty statement and check your battery before requesting repair. During the warranty period any defective test tool can be returned to your Amprobe® Test Tools distributor for an exchange for the same or like product. Please check the "Where to Buy" section on www.amprobe.com for a list of distributors near you. Additionally, in the United States and Canada In-Warranty repair and replacement units can also be sent to a Amprobe® Test Tools Service Center (see next page for address).

Non-Warranty Repairs and Replacement – US and Canada

Non-warranty repairs in the United States and Canada should be sent to a Amprobe® Test Tools Service Center. Call Amprobe® Test Tools or inquire at your point of purchase for current repair and replacement rates.

In USA In Canada

Amprobe Test Tools	Amprobe Test Tools
Everett, WA 98203	Mississauga, ON L4Z 1X9
Tel: 888-993-5853	Tel: 905-890-7600
Fax: 425-446-6390	Fax: 905-890-6866

Non-Warranty Repairs and Replacement – Europe

European non-warranty units can be replaced by your Amprobe® Test Tools distributor for a nominal charge. Please check the "Where to Buy" section on www.amprobe.com for a list of distributors near you.

Amprobe® Test Tools Europe
In den Engematten 14
79286 Glottertal, Germany
tel: +49 (0) 7684 8009 - 0

*(Correspondence only – no repair or replacement available from this address. European customers please contact your distributor.)

AM-140-A / AM-160-A Precision DMM with TRMS & PC Connection

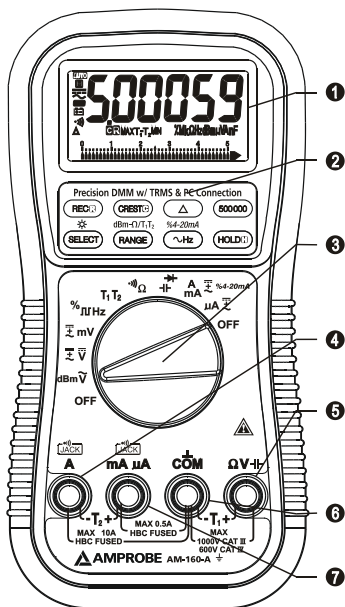











- 1 5-4/5 digits 500000 counts LCD display
- 2 Push-buttons for special functions & features
- 3 Selector to turn the Power On or Off and select a function
- 4 Input Jack for 10A (+) (20A for 30sec) current, and for T2 (-) function
- 5 Input Jack (+) for all functions EXCEPT current (μA , mA, A) and T2 functions
- 6 Common (Ground reference) Input Jack (-) for all functions EXCEPT T2 function
- 7 Input Jack (+) for milli-amp, microamp, and T2 (+) functions

CONTENTS

SYMBOLS	1
UNPACKING AND INSPECTION	3
FEATURES	3
OPERATION	5
AC Voltage, DC Voltage, DC+AC Voltage, & \sim Hz Line Level Frequency	5
\square Hz Logic Level Frequency and % Duty Cycle functions.....	7
T1-T2 Dual Channels Temperature function (AM-160-A only)	8
Ω Resistance, \bullet) Continuity functions.....	9
 Capacitance, + Diode test function	9
μ A, mA, A, and %4-20mA Current functions	10
PC-COMM computer interface capabilities	11
MAX/MIN RECORDING mode	12
CREST Capture (Instantaneous Peak Hold) mode	12
Δ Relative Zero mode.....	12
500000 high resolution stable mode	12
Backlighted display	12
Manual or Auto-ranging	13
Hold \square	13
Set Beeper Off.....	13
Beep-Jack™ Input Warning.....	13
Intelligent Auto Power Off (APO).....	13
Disabling Auto Power Off	13
SPECIFICATION	14
MAINTENANCE AND REPAIR	21
Trouble shooting.....	22
Cleaning and Storage	22
Battery and Fuse replacement	22

SYMBOLS

	Caution ! Risk of electric shock
	Caution ! Refer to the explanation in this Manual
	Double Insulation or Reinforced insulation
	Alternating Current (AC).
	Direct Current (DC).
	Fuse
	Earth (Ground)
	Please remove all the test leads before performing maintenance, cleaning, battery replacement, fuse replacement, etc
	Complies with European Directives
	Conforms to relevant Australian standards
	Do not dispose of this product as unsorted municipal waste. Contact a qualified recycler for disposal

Safety Information

This manual contains information and warnings that must be followed for operating the instrument safely and maintaining the instrument in a safe operating condition. If the instrument is used in a manner not specified by the manufacturer, the protection provided by the instrument may be impaired. The meter is intended only for indoor use.

The meter protection rating, against the users, is double insulation per IEC61010-1 2nd Ed., EN61010-1 2nd Ed., UL61010-1 2nd Ed. and CAN/CSA C22.2 No. 61010.1-0.92 to Category III 1000 Volts AC & DC and Category IV 600 Volts AC & DC.

AM-140-A Terminals (to COM) measurement category:

V : Category III 1000 Volts AC & DC, and Category IV 600 Volts AC & DC.

A / mA : Category III and Category IV 600 Volts AC and 300 Volts DC.

AM-160-A Terminals (to COM) measurement category:

V / A / mA : Category III 1000 Volts AC & DC, and Category IV 600 Volts AC & DC.

Per IEC61010-1 2nd Ed. (2001) Measurement Category

Measurement Category IV (CAT IV) is for measurements performed at the source of the low-voltage installation. Examples are electricity meters and measurements on primary overcurrent protection devices and ripple control units.

Measurement Category III (CAT III) is for measurements performed in the building installation. Examples are measurements on distribution boards, circuit-breakers, wiring, including cables, bus-bars, junction boxes, switches, socket-outlets in the fixed installation, and equipment for industrial use and some other equipment, for example, stationary motors with permanent connection to the fixed installation.

Measurement Category II (CAT II) is for measurements performed on circuits directly connected to the low voltage installation. Examples are measurements on household appliances, portable tools and similar equipment.

Terms In This Manual

⚠ WARNING - identifies conditions and actions that could result in serious injury or even death to the user.

⚠ CAUTION - identifies conditions and actions that could cause damage or malfunction in the instrument.

⚠ WARNING

To reduce the risk of fire or electric shock, do not expose this product to rain or moisture. To avoid electrical shock hazard, observe the proper safety precautions when working with voltages above 60 VDC or 30 VAC rms. These voltage levels pose a potential shock hazard to the user. Do not touch test lead tips or the circuit being tested while power is applied to the circuit being measured. Keep your fingers behind the finger guards of the test leads during measurement. Inspect test leads, connectors, and probes for damaged insulation or exposed metal before using the instrument. If any defects are found, replace them immediately. Do not measure any current that exceeds the current rating of the protection fuse. Do not attempt a current measurement to any circuit where the open circuit voltage is above the protection fuse voltage rating. Suspected open circuit voltage should be checked with voltage functions. Never attempt a voltage measurement with the test lead inserted into the $\mu A/mA$ or A input jack. Only replace the blown fuse with the proper

rating as specified in this manual. Only use the accompanied test leads, or replace with the same rating or better.

⚠ CAUTION

Disconnect the test leads from the test points before changing functions. Always set the instrument to the highest range and work downward for an unknown value when using manual ranging mode.

CENELEC Directives

The instruments conform to CENELEC Low-voltage directive 2006/95/EC and Electromagnetic compatibility directive 2004/108/EC

UNPACKING AND INSPECTION

Your shipping carton should include:

- 1 AM-140-A or AM-160-A Meter
- 1 Test Leads (Black x 1; Red x 1)
- 1 K Type thermal couple with banana plug (For AM-160-A only)
- 1 Users Manual
- 1 Single Alkaline 9V battery; NEDA1604A, JIS6AM6 OR IEC6LF22(Installed)

If any of the items are damaged or missing, return the complete package to the place of purchase for an exchange.

FEATURES

Average sensing RMS calibrated

RMS (Root-Mean-Square) is the term used to describe the effective or equivalent DC value of an AC signal. Most digital multimeters use average sensing RMS calibrated technique to measure RMS values of AC signals. This technique is to obtain the average value by rectifying and filtering the AC signal. The average value is then scaled upward (calibrated) to read the RMS value of a sine wave. In measuring pure sinusoidal waveform, this technique is fast, accurate, and cost effective. In measuring non-sinusoidal waveforms, however, significant errors can be introduced because of different scaling factors relating average to RMS values.

AC True RMS

AC True RMS, normally refers as True RMS, identifies a DMM function that is AC coupled, and responds accurately only to the effective RMS AC component value regardless of the waveforms. However, DC component plays an important role in the distorted non-symmetrical waveforms, and will also be of interest sometimes. A full wave rectified sine waveform is a good example, and the AC true RMS function will only give the AC component reading which is at 43.6% of the total effective DC+AC RMS reading.

DC+AC True RMS

DC+AC True RMS calculates both of the AC and DC components given by the expression $\sqrt{DC^2 + (AC\ rms)^2}$ when making measurement, and can respond accurately to the total effective RMS value regardless of the waveform. Distorted waveforms with the presence of DC components and harmonics may cause:

- Overheated transformers, generators and motors to burn out faster than normal
- Circuit breakers to trip prematurely
- Fuses to blow
- Neutrals to overheat due to the triplen harmonics present on the neutral
- Bus bars and electrical panels to vibrate

AC Bandwidth

AC bandwidth of a DMM is the range of frequencies over which AC measurements can be made within the specified accuracy. It is not the frequency measurement function, and is the frequency response of the AC functions. A DMM cannot accurately measure the AC value with frequency spectrums beyond the AC bandwidth of the DMM. Therefore, wide AC bandwidth plays an important role in high performance DMMs. In reality, complex waveforms, noise and distorted waveforms contain much higher frequency spectrum than its fundamental.

NMRR (Normal Mode Rejection Ratio)

NMRR is the DMM's ability to reject unwanted AC noise effect that can cause inaccurate DC measurements. NMRR is typically specified in terms of dB (decibel). This series has a NMRR specification of > 60dB at 50 and 60Hz, which is a good and definite ability to reject the effect of AC noise when making DC measurements.

CMRR (Common Mode Rejection Ratio)

Common mode voltage is voltage present on both the COM and VOLTAGE input terminals of a DMM, with respect to ground. CMRR is the DMM's ability to reject common mode voltage effect that can cause digit rolling or offset in voltage

measurements. This series has a CMRR specifications of > 80dB at DC to 60Hz in ACV function; and > 120dB at DC, 50 and 60Hz in DCV function. If neither NMRR nor CMRR specification is specified, a DMM's performance will be uncertain.

Analog bar-graph

The analog bar graph provides a visual indication of measurement like a traditional analog meter needle. It is excellent in detecting faulty contacts, identifying potentiometer clicks, and indicating signal spikes during adjustments. Analog bar-graph is not available in AC+DC True RMS Voltage & Current modes.

OPERATION

⚠ CAUTION

Before and after hazardous voltage measurements, test the voltage function on a known source such as line voltage to determine proper meter functioning.

AC Voltage, DC Voltage, DC+AC Voltage, & \sim Hz Line Level Frequency

In AC Voltage, press SELECT button momentarily to toggle between AC and dBm. In DC Voltage, press SELECT button momentarily to toggle between DC, and DC+AC. In mV Voltage, press SELECT button momentarily to select DC, AC, or DC+AC. The new settings will be saved automatically to the nonvolatile memory as power up default. In DCV and DCmV, press 500000 button momentarily to toggle between 4-4/5 digits and 5-4/5 digits readings. In voltage or current functions, press the Hz push button momentarily to activate or to exit Line Level Frequency measuring function. Line Level Frequency measuring function is designed especially for noisy electrical high voltage signals.

Note: In dBm function, power up default reference impedance will be displayed for 1 second before displaying the dBm readings. Press dBm- Ω (RANGE) button momentary to select different reference impedance of 4, 8, 16, 32, 50, 75, 93, 110, 125, 135, 150, 200, 250, 300, 500, 600, 800, 900, 1000, up to 1200 Ω . The new impedance value will be saved automatically to the non-volatile memory as power up default.

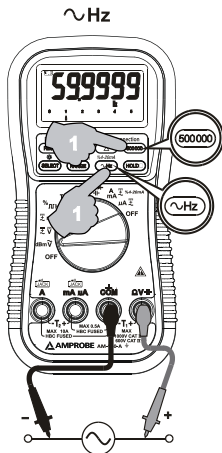
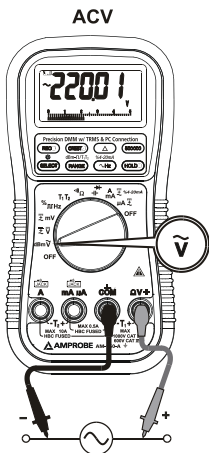
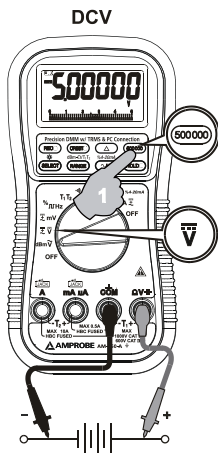
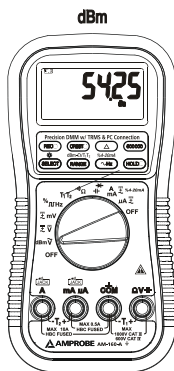
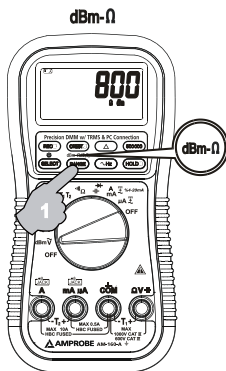
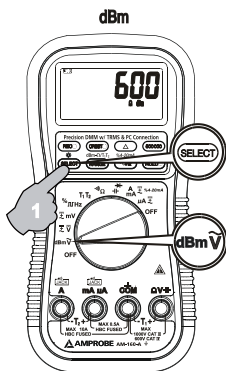

Note: Line Level Frequency measuring function input sensitivity varies automatically with voltage (or current) function range selected. The lower the measuring range the higher the sensitivity. That is, mV function has the highest and the 1000V range has the lowest as in voltage function ranges. It is recommended to first measure the signal voltage (or current) level then activate the Hz function in that voltage (or current) range to automatically get the most appropriate trigger level. When activated from voltage function, you can also press the RANGE button momentarily to select another trigger level range manually. The analog bargraph pointer will point at the selected trigger level range scale 1, 2, 3, or 4. If the Hz reading is unstable, select lower sensitivity to avoid electrical noise. If the reading shows zero, select higher sensitivity.

⏏ Hz Logic Level Frequency and % Duty Cycle functions

Press SELECT button momentarily to toggle between Hz and % (duty cycle) readings. The new setting will be saved automatically to the non-volatile memory as power up default. Press 500000 button momentarily to toggle between 5 full digits and 6 full digits Hz readings.

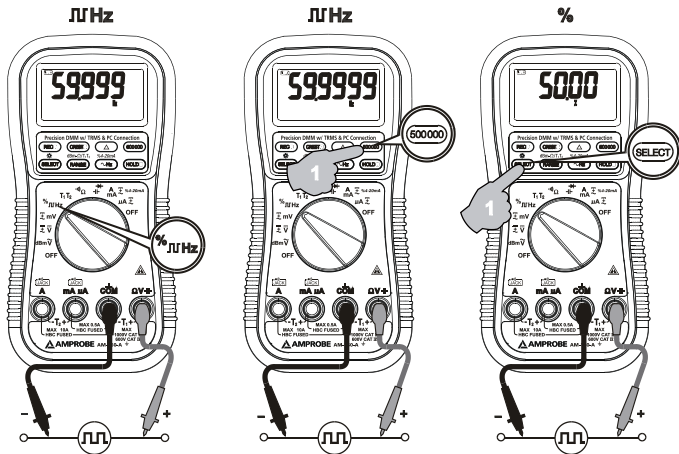

Note: Unlike the Line Level Frequency measuring function as previously stated, this Logic Level Frequency function is set only at the highest input sensitivity for measuring digital type electronic signals.

T1-T2 Dual Channels Temperature function (AM-160-A only)

Press SELECT button momentarily to toggle between °C and °F readings, and the new setting will be saved automatically in the non-volatile memory as power up default. Press T1-T2 (RANGE) button momentarily to select T1, T2, or T1-T2 readings.

Note: Insert the banana plug K-type temperature bead probe with correct **+** **-** polarities. Dual channels T1-T2 readings require 2 probes. You can also use a plug adapter (Optional purchase) with banana pins to K-type socket to adapt other standard K type mini plug temperature probes.

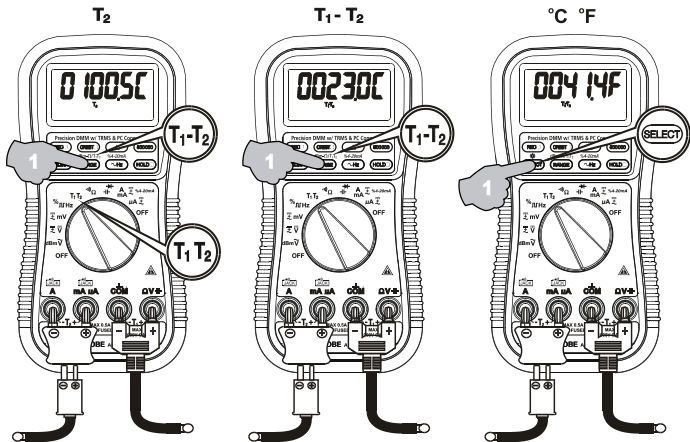

Ω Resistance, $\bullet\))$ Continuity functions

Press SELECT button momentarily to toggle between Ω and $\bullet\))$ Continuity functions. The new setting will be saved automatically to the non-volatile memory as power up default. Continuity function is convenient for checking wiring connections and operation of switches. A continuous beep tone indicates a complete wire.

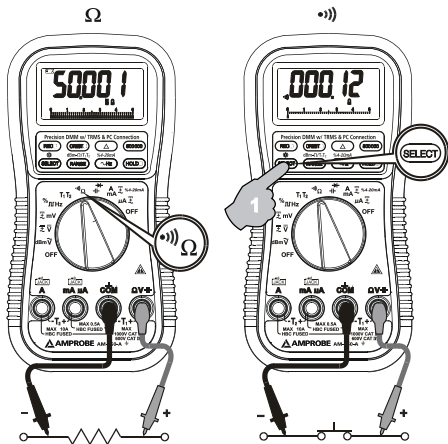

⚠ CAUTION

Using resistance or continuity function in a live circuit will produce false results and may damage the meter. In many cases the suspected component must be disconnected from the circuit to obtain an accurate reading.

||| Capacitance, ➤ Diode test function

Press SELECT button momentarily to toggle between ||| Capacitance and ➤ Diode test functions. The new setting will be saved automatically to the non-volatile memory as power up default.

⚠ CAUTION

Discharge capacitors before making any measurement. Large value capacitors should be discharged through an appropriate resistance load.

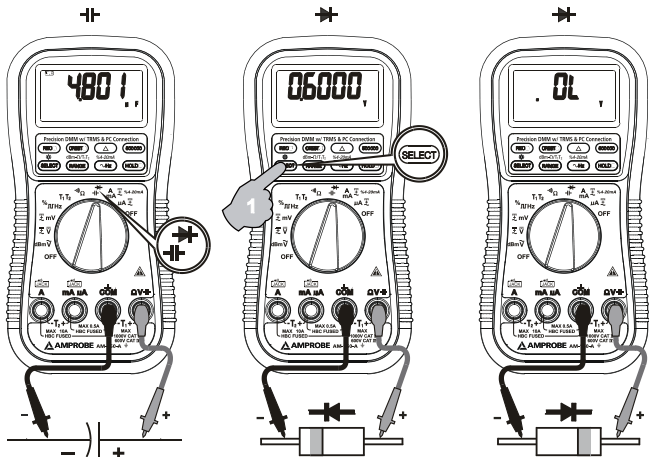

Note: Normal forward voltage drop (forward biased) for a good silicon diode is between 0.400V to 0.900V. A reading higher than that indicates a leaky diode (defective). A zero reading indicates a shorted diode (defective). An OL indicates an open diode (defective). Reverse the test leads connections (reverse biased) across the diode. The digital display shows OL if the diode is good. Any other readings indicate the diode is resistive or shorted (defective).

μ A, mA, A, and %4-20mA Current functions

Insert the red test lead into the correct μ A/mA or A input jack. Press SELECT button momentarily to select DC, AC, or DC+AC. The new settings will be saved automatically to the non-volatile memory as power up default. In DC mA function, neither in AC nor in DC+AC, press and hold the %4-20mA (~ Hz) button for 1 second or more to display the current digital data in terms of loop current percentage (%) value. It is set at 4mA = 0% (zero) and 20mA = 100% (span) with 0.01% high resolution, which virtually extends the meters' capability to test and regulate the externally powered loop current in the industrial process control applications. The analog bar-graph remains showing the mA current value to alert the user.

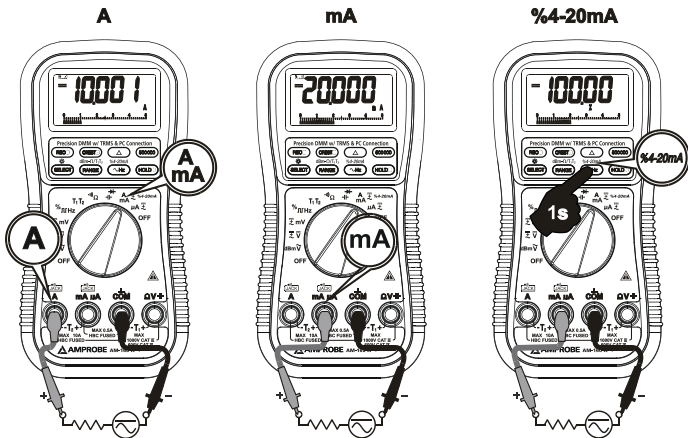

⚠ Warning

When measuring a 3-phase system, special attention should be taken to the phase-to-phase voltage that is significantly higher than the phase-to-earth voltage. To avoid exceeding the voltage rating of the protection fuse(s) accidentally, always consider the phase-to-phase voltage as the working voltage for the protection fuse(s).

PC-COMM computer interface capabilities

The instrument equips with an optical isolated interface port at the meter back for data communication. Optional purchase PC interface kit USB-KIT3 is required to connect the meter to the PC computer. The USB-KIT3 Data Recording System software equips with a digital meter, an analog meter, a comparator meter, and a Data Graphical recorder display. Refer to the README file in the interface kit for further details.

MAX/MIN RECORDING mode

Press REC button momentarily to activate MAX/MIN recording mode. The LCD annunciators "R" and "MAX MIN" turn on. The meter beeps when new maximum or minimum reading is updated. Press the button momentarily to read throughout the Maximum (MAX), Minimum (MIN), and Maximum minus Minimum (MAX-MIN) readings. Press the button for 1 second or more to exit MAX/MIN recording mode. Auto Power Off feature will be disabled automatically in this mode.

CREST Capture (Instantaneous Peak Hold) mode

Press CREST button momentarily to activate CREST mode to capture voltage or current signal duration as short as 0.8ms. This mode is available in DC, AC, DC+AC modes of voltage and current functions. The LCD annunciators "C" & "MAX" turn on. The meter beeps when new maximum or minimum reading is updated. Press the button momentarily to read throughout the Maximum (MAX), Minimum (MIN), and Maximum minus Minimum (MAX-MIN) readings. Press the button for 1 second or more to exit CREST capture mode. Auto Power Off feature will be disabled automatically in this mode.

△Relative Zero mode

Relative Zero allows the user to offset the meter consecutive measurements with the displaying reading as the reference value. Practically MAX/MIN recording feature readings can also be set as relative reference value. Press the △ button momentarily to activate and to exit Relative Zero mode.

500000 high resolution stable mode

In DC voltage and frequency functions, press the 500000 button momentarily to toggle between the 4-4/5 digits fast mode and the 5-4/5 digits high resolution stable mode.

Backlighted display

Press the SELECT button for 1 second or more to turn on or off the display backlight function. It will also be turned off automatically after 30 seconds to extend battery life.

Manual or Auto-ranging

Press the RANGE button momentarily to select manual-ranging mode, and the meter will remain in the range it was in, the LCD annunciator **AUTO** turns off. Press the button momentarily again to step through the ranges. Press and hold the button for 1 second or more to resume auto-ranging mode.

Note: Manual ranging mode feature is not available in Hz function.

Hold

The hold function freezes the display for later view. Press the HOLD  button momentarily to activate or to exit the hold function.

Set Beeper Off

Press the  Hz button while turning the meter on to disable the push button operating beeper feature. However, the continuity and Jack Beep input warning features remain.

Beep-Jack™ Input Warning

The meter beeps as well as displays “InErr” to warn the user against possible damage to the meter due to improper connections to the μA , mA, or A input jacks when other function (like voltage function) is selected.

Intelligent Auto Power Off (APO)

The Intelligent Auto Power Off (APO) mode turns the meter off automatically to extend battery life after approximately 17 minutes of no activities. Activities are specified as: 1) Rotary switch or push button operations, and 2) Significant measuring readings of above 10% of range or non-OL Ω readings. In other words, the meter will intelligently avoid entering the APO mode when it is under normal measurements. To wake up the meter from APO, press the RECORD button momentarily or turn the rotary switch to the OFF position and then turn back on again. Always turn the rotary switch to the OFF position when the meter is not in use.

Disabling Auto Power Off

Press the RANGE button while turning the meter on to disable the Auto Power Off (APO) feature.

SPECIFICATIONS

General Specifications

Display:	4-4/5 digits 50,000 counts. Selectable stable mode 5-4/5 digits 500,000 counts for DC voltage, & 6 digits 999,999 counts for HZ
Polarity:	Automatic
Update rate:	4-4/5 digits fast mode: 5 per second nominal; 5-4/5 digits stable mode: 1.25 Per second nominal;
42 Segments bar graph:	60 per second max
Operating temperature:	0°C to 45°C (32°F to 113°F)
Relative humidity:	Maximum relative humidity 80% for temperature up to 31°C decreasing linearly to 50% relative humidity at 45°C
Pollution degree:	2
Storage temperature:	-20°C to 60°C (-4°F to 140°F), < 80% R.H. (With battery removed)
Altitude:	Operating below 2000m
Temperature coefficient:	Nominal 0.1 X (specified accuracy)/ °C @ (0°C - 18°C or 28°C -- 40°C/32°F - 104°F), or otherwise specified
Sensing:	AC, AC+DC true RMS
Safety:	Double insulation per IEC61010-1 2nd ed., EN61010-1 2nd ed., UL61010-1 2nd ed. & Can/csa c22.2 No. 61010.1-0.92 To category III 1000V AC & DC and category IV 600V AC & DC
Am-140-a terminals (to COM) measurement category:	V : Category III 1000 VAC & VDC and category IV 600 VAC & VDC. A / mA μA: Category III and category IV 600 VAC and 300 VDC.
Am-160-a terminals (to COM) measurement category:	V / A / mA μA: Category III 1000 VAC & VDC and category IV 600 VAC & VDC.

Overload protections:	<p>Am-140-a: μA & mA: 1A/600V, IR 10kA or better, F fuse A: 10A/600V, IR 100kA or better, F fuse V: 1050VRMS, 1450VPEAK mV, Ω, & others: 600 VDC & VAC RMS</p> <p>Am-160-a: μA & mA: 0.44A/1000V, IR 10kA or better, F fuse A: 11A/1000V, IR 20kA or better, F fuse V, mV, Ω, & others: 1050VRMS, 1450VPEAK</p>
Transient protection:	8kV (1.2/50μS SURGE)
E.M.C.:	Meets en61326-1:2006 (EN55022, EN61000-3-2, EN61000-3-3, EN61000-4-2, EN61000-4-3, EN61000-4-4, , EN61000-4-5, EN61000-4-6, EN61000-4-8, EN61000-4-11)
In an RF field of 3V/m:	Capacitance function is not specified
Other function ranges:	Total accuracy = specified accuracy + 100 digits. Performance above 3V/m is not specified
Power supply:	Single alkaline 9V battery; neda1604a, jis6am6 or lec6lf22
Power consumption:	6mA typical
Low battery:	Below approx. 7V
Apo timing:	Idle for 17 minutes
Apo consumption:	55μA typical for am-140-a; 30μA typical for am-160-a
Dimension:	L186mm x W87mm x H35.5mm (7.3in x 3.4in x 1.4in); L198mm x W97mm x H55mm (7.8in x 3.8in x 2.2in) with holster
Weight:	390 gm (0.9lb); 500 gm (1.1lb) with holster

Electrical Specifications

Accuracy is \pm (% reading digits + number of digits) or otherwise specified, at $23^{\circ}\text{C} \pm 5^{\circ}\text{C}$ & less than 75% relative humidity.

True rms voltage & current accuracies are specified from 5 % to 100 % of range or otherwise specified. maximum crest factor < 5:1 at full scale & < 10:1 at half scale, and with frequency components within the specified frequency bandwidth for non-sinusoidal waveforms.

DC Voltage

Range	AM-160-A	AM-140-A
	Accuracy	
500.00 MV, 5.0000V, 50.000V	0.02% + 2D	0.03% + 2D
500.00V	0.04%+2D	0.05% + 2D
1000.0V	0.05%+ 2D	0.1%+2D

NMRR: >60DB @ 50/60HZ

CMRR: >120DB @ DC, 50/60HZ, RS=1K Ω

Input Impedance: 10M Ω , 30pF nominal (80pF nominal for 500mV range)

Ohms

Range	AM-160-A	AM-140-A
	Accuracy	
500.00 Ω	0.07%+10D	0.1%+6D
5.0000K Ω	0.07%+2D	
50.000K Ω		
500.00K Ω		
5.0000M Ω	0.2%+6D	0.4%+6D
50.000M Ω	2.0%+6D	2.0%+6D

Open Circuit Voltage: < 1.3VDC (< 3VDC FOR 500 Ω RANGE)

PAC & AC+DC Voltage

Range	AM-160-A	AM-140-A
	Accuracy*	
20HZ -- 45HZ		
500.00MV, 5.0000V, 50.000V	1.5% + 60D	UNSPEC'D
500.00V, 1000.0V	UNSPEC'D	
45HZ -- 300HZ		
500.00MV	0.3% + 20D	0.8%+60D
5.0000V, 50.000V	0.8% + 20D	
500.00V,1000.0V	0.4% + 40D	
	300HZ -- 5KHZ	300HZ -- 1KHZ
500.00MV	0.3% + 10D	0.8%+40D
5.0000V , 50.000V , 500.00V	0.4% + 40D	2.0%+60D
1000.0V	0.8% + 40D (300HZ--1KHZ)	1.0%+40D
	5KHZ -- 20KHZ	1KHZ -- 20KHZ
500.00MV	0.5%+20D	1DB**
5.0000V, 50.000V	0.8%+20D	2DB**
500.00V	0.5%+20D	3DB**
1000.0V	UNSPEC'D	UNSPEC'D
20KHZ -- 100KHZ		
500.00MV	2.5%+40D	
5.0000V, 50.000V	4.0%+40D**	
500.00V	UNSPEC'D	
1000.0V		

***from 5% to 10% of range:** accuracy % of reading (or in db) + 80d

****from 5% to 10% of range:** accuracy % of reading (or in db) + 180d

****from 10% to 15% of range:** accuracy % of reading (or in db) + 100d

cmrr: >80db @ dc to 60hz, $r_s=1k\Omega$

input impedance: 10m Ω 30pf nominal (80pf nominal for 500mv range) residual reading less than 50 digits with test leads shorted.

DBM: at 600 Ω , -11.76dbm to 54.25dbm

accuracy: $\pm 0.25db + 2d$ (@40hz -- 20khz)

input impedance: 10m Ω , 30pf nominal

selectable reference impedance of 4, 8, 16, 32, 50, 75, 93, 110, 125, 135, 150, 200, 250, 300, 500, 600,800, 900, 1000, 1200 Ω

•)) AUDIBLE CONTINUITY TESTER

Audible threshold: between 20 Ω and 200 Ω response time < 100 μs

➔ Diode Tester

Range	Accuracy	Test Current (Typical)	Open Circuit Voltage
5.0000V	1%+1D	0.4mA	< 3.5 VDC

Capacitance

Range	Accuracy*
50.00nF	0.8% + 3D
500.0nF	0.8% + 3D
5.000 μF	1.5% + 3D
50.00 μF	2.5% + 3D
500.0 μF **	3.5% + 5D
9999 μF **	5.0% + 5D

*accuracies with film capacitor or better

**in manual-ranging mode, measurements not specified below 45.0 μF and 450 μF for 500.0 μF and 9999 μF ranges respectively

DC Current

Range	Accuracy	Burden Voltage
500.00 μ A	0.15%+20D	0.15mV/ μ A
5000.0 μ A	0.1%+20D	0.15mV/ μ A
50.000mA	0.15%+20D	3.3mV/mA
500.00mA	0.1%+30D	3.3mV/mA
5.0000A	0.5%+20D	45mV/A
10.000A*	0.5%+20D	45mV/A

*10A continuous, >10A to 15A (TO 20A for AM-160-A) for 30 second max with 5 minutes cool down interval

AC & AC+DC Current

Range	AM-160-A	AM-140-A	Burden Voltage
	Accuracy		
50HZ -- 60HZ			
500.00 μ A	0.5%+50D	1.0%+40D	0.15mV/ μ A
5000.0 μ A			0.15mV/ μ A
50.000mA			3.3mV/mA
500.00mA			3.3mV/mA
5.0000A			45mV/A
10.000A*			45mV/A
40HZ – 1KHZ			
500.00 μ A	0.7%+50D	1.0%+40D	0.15mV/ μ A
5000.0 μ A			0.15mV/ μ A
50.000mA			3.3mV/MA
500.00mA			3.3mV/MA
5.0000A			45mV/A
10.000A*			45mV/A

1KHZ – 10KHZ			
500.00μA	2.0%+50D	UNSPEC'D	0.15mV/μA
5000.0μA			0.15mV/μA
50.000mA			3.3mV/mA
500.00mA			3.3mV/mA
5.0000A 10.000A*	UNSPEC'D	UNSPEC'D	45mV/A

*10A continuous, >10A to 15A (to 20A FOR AM-160-A) for 30 second max with 5 minutes cool down interval

DC LOOP CURRENT %4--20MA

4mA = 0% (zero)

20mA = 100% (span)

Resolution: 0.01%

Accuracy: $\pm 25D$

Crest mode (Instantaneous Peak Hold)

Accuracy: specified accuracy ± 100 digits for changes > 0.8ms in duration

T1-T2 Dual Temperature (AM-160-A only)

Range	Accuracy
-50.0°C TO 1000.0°C	0.3%+1°C
-58.0°F TO 1832.0°F	0.3%+2°F

Thermocouple range & accuracy not included

~ Hz Line Level Frequency

Function Range	Sensitivity (Sine Rms)	Range
500mV	100mV	10HZ ~ 200KHZ
5V	1V	10HZ ~ 200KHZ
50V	10V	10HZ ~ 100KHZ
500V	100V	10HZ ~ 100KHZ

1000V	900V	10HZ ~ 10KHZ
-------	------	--------------

Accuracy: 0.02%+4d

Hz Logic Level Frequency

Range	Accuracy
5.0000HZ--2.00000MHZ	0.002%+4D

Sensitivity: 2.5VP square wave

%DUTY CYCLE

Range	Accuracy
0.1% -- 99.99%	3D/KHZ+2D

Input frequency: 5HZ -- 500 KHZ, 5V logic family

MAINTENANCE AND REPAIR

WARNING

To avoid electrical shock, disconnect the meter from any circuit, remove the test leads from the input jacks and turn OFF the meter before opening the case. Do not operate with open case. Install only the same type of fuse or equivalent

Calibration

Periodic calibration at intervals of one year is recommended to maintain meter accuracy. Accuracy is specified for a period of one year after calibration.

If self-diagnostic message "rE-O" is being displayed while powering on, the meter is re-organizing internal parameters. Do not switch off the meter then, and it will be back to normal measurement shortly. However, if self-diagnostic message "C_Er" is being displayed while powering on, some meter ranges might be largely out of specifications. To avoid mis-leading measurements, stop using the meter and send it for re-calibration. Refer to the LIMITED WARRANTY section for obtaining warranty or repairing service.

Trouble Shooting

If the instrument fails to operate, check battery, fuses, leads, etc., and replace as necessary. Double check operating procedure as described in this user's manual. If the instrument voltage-resistance input terminal has subjected to high voltage transient (caused by lightning or switching surge to the system) by accident or abnormal conditions of operation, the series fusible resistors will be blown off (become high impedance) like fuses to protect the user and the instrument. Most measuring functions through this terminal will then be open circuit. The series fusible resistors and the spark gaps should then be replaced by qualified technician. Refer to the LIMITED WARRANTY section for obtaining warranty or repairing service.

Cleaning and Storage

Periodically wipe the case with a damp cloth and mild detergent; do not use abrasives or solvents. If the meter is not to be used for periods of longer than 60 days, remove the battery and store it separately.

Battery and Fuse Replacement

Battery use:

9V alkaline battery NEDA1604A, JIS6AM6 or IEC6LF22

AM-140-A

Fuse (FS1) for μ mA current input: 1A/600V, IR 10kA or better, F fuse;

Fuse (FS2) for A current input: 10A/600V, IR 100kA or better, F fuse

AM-160-A

Fuse (FS1) for μ mA current input: 0.44A/1000V, IR 10kA or better, F fuse

Fuse (FS2) for A current input: 11A/1000V, IR 20kA or better, F fuse

Battery replacement for models with battery access door:

Loosen the 2 screws from the battery access door of the case bottom. Lift the battery access door and thus the battery compartment up. Replace the battery. Re-fasten the screws.

Fuse replacement:

Loosen the 4 screws from the case bottom. Lift the end of the case bottom nearest the input jacks until it unsnaps from the case top. Replace the blown fuse(s) and/or the battery. Replace the case bottom, and ensure that all the gaskets are properly seated and the two snaps on the case top (near the LCD side) are engaged. Re-fasten the screws.

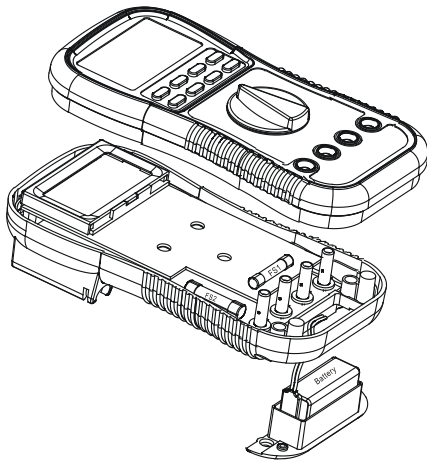

Visit www.Amprobe.com for

- Catalog
- Application notes
- Product specifications
- User manuals



Please Recycle