

Installation Instructions for Appleton™ Contender® EDS-EDSC Series 1- and 2-Gang Control Assemblies for Use In Class I, Group C and D, Class II, Group E, F, and G, and CLASS III, Division 1 and 2 Hazardous Locations

⚠ WARNING: Electrical power must be turned OFF before and during installation and maintenance. Failure to follow safety instructions may cause ignition of hazardous atmospheres resulting in serious personal injury and/or property damage.

⚠ CAUTION: Care must be taken to prevent the ground surface of the bodies and covers from becoming scratched, dented, or otherwise damaged as this could affect the explosion-proof features of these assemblies. Appleton control assembly covers and devices are UL Listed for use with Appleton listed control assembly bodies, and are UL Classified for use with UL Listed Crouse-Hinds bodies shown below.

ASSEMBLY: Check ground surfaces of all components for foreign material prior to assembly. Surfaces must be clean and undamaged. Install the desired cover and device assembly on the body. Secure the cover assembly to the body by tightening the screw provided with the cover.

The following cover with device and combination of cover and device are UL Listed control assemblies when assembled to Appleton bodies and are UL Classified for use with the Crouse-Hinds bodies listed below. These combinations are suitable for use in Class I, Group C and D; Class II, Group E, F, and G; and Class III hazardous locations.

COVER WITH DEVICE*	FACTORY SEALED?	ELECTRICAL RATING
EDKL-U3	YES	PUSHBUTTON SWITCH 600 VAC MAX. HEAVY PILOT DUTY
EDKL-J3	YES	
EDKL-J1U2	YES	
EDKL-J2U1	YES	
EDK-DPB	NO	
EDKB-12	YES	
EDKB-35	YES	
EDKB-102	YES	
EDKB-345	YES	
EDKB-DU1	YES	
EDKB-DU2	YES	
EDKB-J1**	YES	
EDKB-J1DU1	YES	
EDKB-J1U1	YES	
EDKB-J1U2	YES	
EDKB-J2	YES	
EDKB-345-S636	YES	
EDKB-U1 †††	YES	
EDKB-U2 †††	YES	
EDSK-B †		
EDKB-102-S634	YES	
EDKB-102-S635	YES	
EDKB-345-S634	YES	
EDKB-345-S635	YES	
EDKB-UM1 †††	YES	
EDKB-DPB	YES	
EDKB-DPBM	YES	
EDKB-RU1	YES	
EDKB-RU2	YES	
EDKB-PC120	YES	125VAC-60HZ 1000VA LOAD
EDKB-PC277	YES	277VAC-60HZ 1000VA LOAD

COMBINATION OF		FACTORY SEALED?	ELECTRICAL RATING
COVER*	DEVICE		
EDSK-MS	EFS-2MS-Q	NO	2P 30A-250VAC, 20A-600VAC, 2HP-230VAC, 3HP-575VAC
EDSK-MS	EFS-3MS-Q	NO	3P 30A-250VAC, 20A-600VAC, 3HP-125VAC, 15HP-600VAC
EDSK-RU1	EDS-RU1-Q	NO	600 VAC MAX
EDSK-RU2	EDS-MRU2-Q	NO	HEAVY PILOT DUTY
EDS-F23W-Q	COVER WITH DEVICE	YES	3W 20A-120VAC, 20A-277VAC, 1HP-120VAC, 2HP-240VAC
EDS-F24W-Q		YES	4W 20A-120VAC, 20A-277VAC, 1HP-120VAC, 2HP-240VAC
EDS-F33W-Q		YES	3W 30A-120VAC, 30A-277VAC, 2HP-120VAC, 2HP-240VAC
EDS-F21-Q		YES	1P 20A-120VAC, 20A-277VAC, 1HP-120VAC, 2HP-240VAC
EDS-F22-Q		YES	2P 20A-120VAC, 20A-277VAC, 1HP-120VAC, 2HP-240VAC
EDS-F31-Q		YES	1P 30A-120VAC, 30A-277VAC, 2HP 120VAC, 2HP-240VAC
EDS-F32-Q		YES	2P 30A-120VAC, 30A-277VAC, 2HP-120VAC, 2HP-240VAC
EDSK-1MSAB		YES	1P 1HP-115/230VAC
EDSK-1MSW***		YES	1P 1HP-115/230VAC, 1/4HP-32VDC, 1/4HP-250DC
EDSK-2MSAB****		YES	2P 1HP-115/230VAC, 3/4HP-32VDC, 3/4HP-250VDC
EDSK-2MSW***		YES	2P 1HP115/230VAC, 1/4HP-32VDC, 1HP-125VDC, 1/4HP-250VDC
EDSK-MC2****		YES	2P 30A-250VAC, 20A-600VAC, 2HP-230VAC, 3HP-575VAC
EDSK-MC3		YES	3P 30A-250VAC, 20A-600VAC, 3HP-125VAC, 15HP-600VAC

* With or without suffix -A
 ** With or without suffix -S801, -S802, -S803, -S804
 *** Heater table supplied with these devices must be affixed in or near the enclosure for future reference
 † Blank cover for use singly with 2-gang body only
 †† Device rating must match rating stamped on cover
 ††† With or without suffix -L

⚠ WARNING: To prevent ignition of Group C and D atmospheres, seals must be installed within five (5) feet on each conduit opening.

APPLETON 2-GANG TANDEM ◆		APPLETON THREE DEVICE	
EDS177	EDSC177	EDS147	EDSC147
EDS277	EDSC277	EDS247	EDSC247
EDS377	EDSC377	EDS347	EDSC347
EDS177-SA	EDSC177-SA	EDS147-SA	EDSC147-SA
EDS277-SA	EDSC277-SA	EDS247-SA	EDSC247-SA
EDS377-SA	EDSC377-SA	EDS347-SA	EDSC347-SA

APPLETON 1-GANG BODY		APPLETON 2-GANG BODY	
EDS171	EDSC171	EDS172	EDSC172
EDS271	EDSC271	EDS272	EDSC272
EDS371	EDSC371	EDS372	EDSC372
EDS171-SA	EDSC171-SA	EDS172-SA	EDSC172-SA
EDS271-SA	EDSC271-SA	EDS272-SA	EDSC272-SA
EDS371-SA	EDSC371-SA	EDS372-SA	EDSC372-SA

CROUSE-HINDS 1-GANG BODY		CROUSE-HINDS 2-GANG BODY	
EDS171	EDSC171	EDS172	EDSC172
EDS271	EDSC271	EDS272	EDSC272
EDS371	EDSC371	EDS372	EDSC372
EDS171-SA	EDSC171-SA	EDS172-SA	EDSC172-SA
EDS271-SA	EDSC271-SA	EDS272-SA	EDSC272-SA
EDS371-SA	EDSC371-SA	EDS372-SA	EDSC372-SA

Installation of Pushbutton Switch and Pilot Light in Contender® EDSK Series Covers

Explosion-Proof and Dust-Ignition-Proof

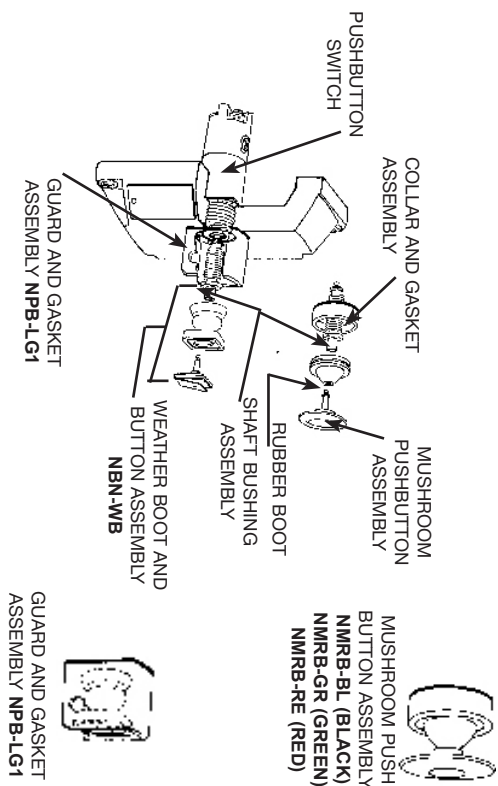
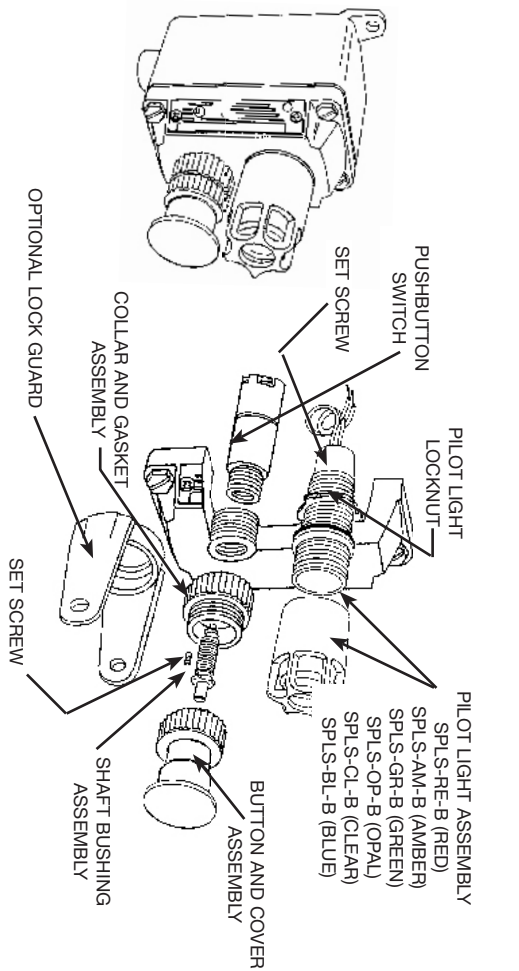

MAINTAINED CONTACT PUSHBUTTON SWITCH AND PILOT LIGHT

1. Pilot light must be installed in 3/4" 14 NPSM opening.
2. Pushbutton switch must be installed in 1/2" 14 NPSM opening.
3. Unscrew button and cover assembly from collar. Remove set screw from collar. Use a 1/2" nut driver to remove shaft bushing and shaft from push assembly. (Set these parts aside for later reassembly in step 5.)
4. Thread Push Button from inside of cover until front of pushbutton is flush with face of cover.
5. Insert shaft into bushing. Put shaft bushing assembly thru hole in collar and thread bushing into pushbutton opening. Hold pushbutton from inside of cover to prevent it from turning. If a Lockout Guard is used, put shaft bushing assembly thru collar and lockout.
6. Tighten shaft bushing with 1/2" nut driver to "lock" pushbutton in place, thread set screw onto collar along side of hex flat of shaft bushing.
7. Thread Button and cover assembly onto collar until fully seated.
8. Check pushbutton switch and pilot light electrically and mechanically for proper operation.

⚠ CAUTION: WHEN CHECKING PUSHBUTTON ELECTRICALLY GUARD OR COLLAR MUST BE INSTALLED IN THE INTENDED MANNER AS SHOWN.

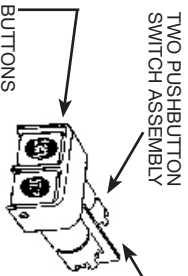
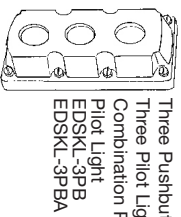
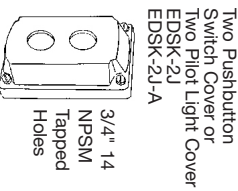
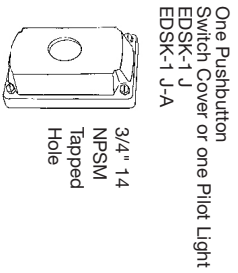

- ### DOUBLE PUSHBUTTON WITH TWO BUTTON GUARD
1. Double Pushbutton assembly, with two button guard must be installed into two 1/2" 14 NPSM openings (approximately 1-1/6" apart).
 2. Proceed as in steps (2) through (6) above. Be sure insulator is in place.

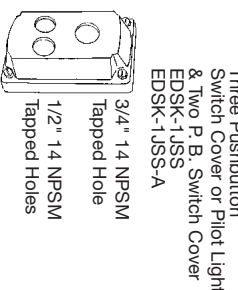
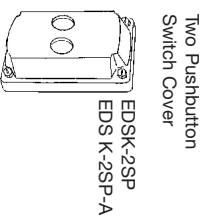

SINGLE PUSHBUTTON SWITCH WITH ONE BUTTON GUARD

1. Single pushbutton with one button guard must be installed in 3/4" 14 NPSM opening.
2. Remove set screw from guard, use a 1/2" nut driver to remove shaft bushing and shaft from pushbutton assembly (set a side for later assembly).
3. Thread pushbutton from inside of cover until front of pushbutton is flush with face of cover
4. Insert shaft into bushing. Put shaft bushing assembly thru hole in guard and thread bushing into pushbutton opening. Hold pushbutton from inside of cover to prevent it from turning.
5. Tighten shaft bushing with a 1/2" nut driver to "lock" pushbutton switch in place. Thread set screw onto collar along side of hex flat on shaft bushing.
6. Press Weather Boot and Button assembly in shaft hole until fully seated.
7. Check pushbutton switch and pilot light electrically and mechanically for proper operation.

Installation of Selector Switch in Contender® EDSK Series Covers Explosion-Proof and Dust-Ignition-Proof

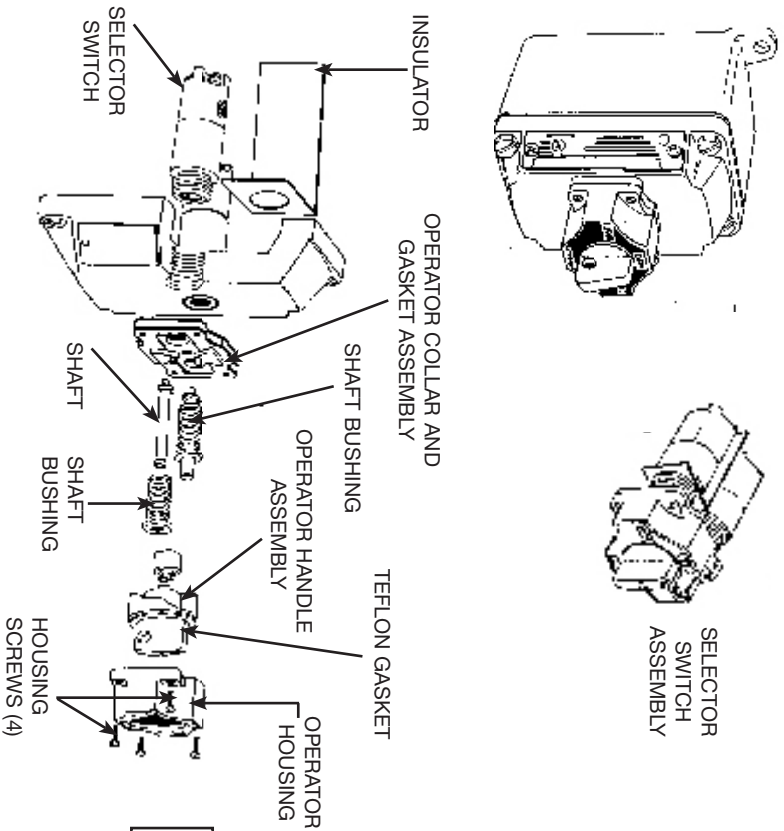

SELECTOR SWITCH

1. Selector Switch must be installed in 1/2" 14 NPSM opening(s).
2. Remove four housing screws, operator housing and handle assembly.
3. Use 1/2" nut driver to remove shaft bushing.
4. Place operator collar and gasket assembly on face of cover and line up openings with the two 1/2" threaded holes in cover. Thread in Selector Switch from inside of cover. (See Note)
5. Insert shaft through shaft bushing. While holding Selector Switch, thread shaft/bushing assembly through collar into Selector Switch and tighten bushing securely.
6. Insert operator handle and teflon gasket in operator housing. With arrow in operator handle pointing to "OFF" marking on nameplate, press operator housing down firmly on operator collar and fasten in place with four (4) housing screws.
7. Check Selector Switches electrically and mechanically for proper operation.

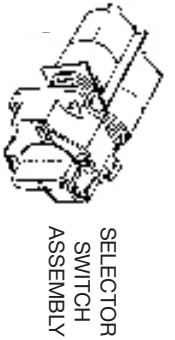

SELECTOR SWITCH ASSEMBLY

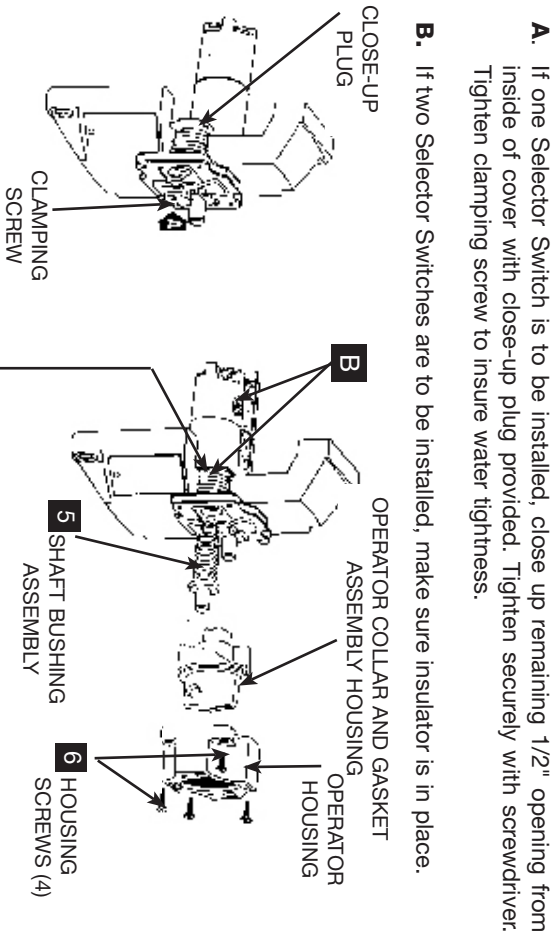

NOTE: Threaded aluminum shell of Selector Switch Assembly **MUST TOUCH** the under side of operator collar gasket for proper operation of mechanism.

TWO POSITION NAMEPLATE

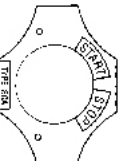

START - STOP

AUTO	OFF	SLNP-AO
AUTO	HAND	SLNP-AH
OFF	REM	SLNP-OR
RUN	JOG	SLNP-RJ
START	STOP	SLNP-SS
ON	OFF	SLNP-OO
UP	DOWN	SLNP-UD
FWD	REV	SLNP-FR
HAND	AUTO	SLNP-HA
BLANK	BLANK	SLNP-B

THREE POSITION NAMEPLATE

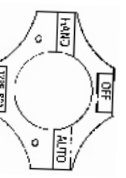

HAND - OFF - AUTO

LOCAL	OFF	REM	SLNP-LOR
HAND	OFF	REM	SLNP-HOR
REV	OFF	FWD	SLNP-ROF
AUTO	OFF	HAND	SLNP-AOH
JOG	OFF	RUN	SLNP-JOR
STOP	RUN	START	SLNP-SRS
D	D	D	SLNP-B3
1	OFF	2	SLNP-102
FWD	OFF	REV	SLNP-FOR
HAND	OFF	AUTO	SLNP-HOA
RUN	OFF	JOG	SLNP-ROU

SELECTOR SWITCH COVERS

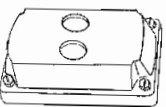

EDSK-2SP
EDSK-2SP-A

Two 1/2" tapped holes

PILOT LIGHT AND SELECTOR SWITCH COVERS

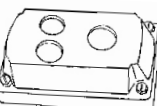

EDSK-1JSS
EDSK-1JSS-A
ESKB-3JPB

One 3/4" tapped hole on top
Two 1/2" tapped holes on bottom

PILOT LIGHTS

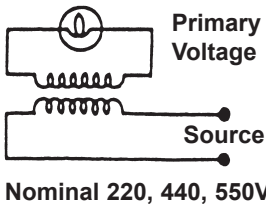
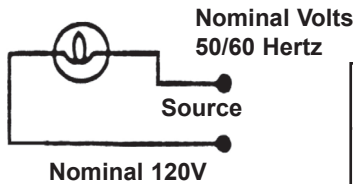

Pilot Light Transformer Voltages above 125 volts	
Nominal Volts 50/60 Hertz Transformer	Primary Voltage Range
220-110	220-240
440-110	440-480
550-110	550-600

SELECTOR SWITCHES

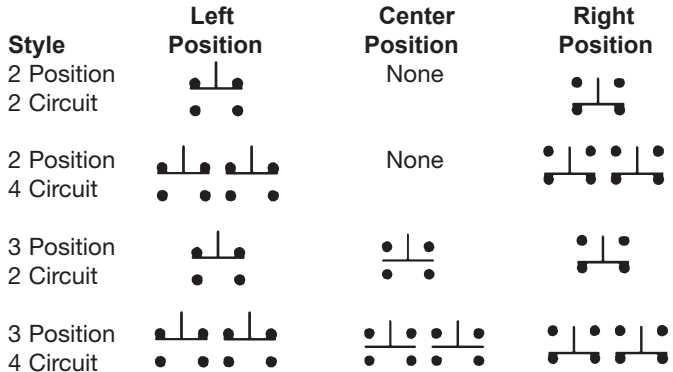

Pushbutton Stations and Selector Switches Screw Terminals

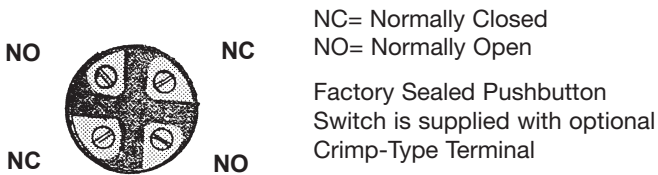

Strip the insulation on each conductor wire back 3/8".

Use a slotted head screwdriver to loosen the field wiring terminal screws the required 3 or 4 turns.

Insert the bare wire conductor(s) on either side of the terminal screw(s), under the terminal wire screw(s), and securely tighten the screw(s). **NOTE: Do Not** exceed 15 in- lbs of torque.

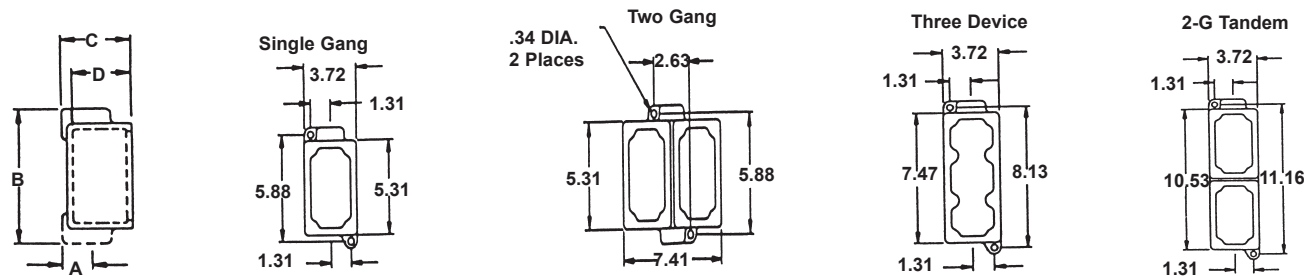

Hub (in.)	Single Gang				Two Gang				Three Device				2-G Tandem			
	Dim. A	Dim. B	Dim. C	Dim. D	Dim. A	Dim. B	Dim. C	Dim. D	Dim. A	Dim. B	Dim. C	Dim. D	Dim. A	Dim. B	Dim. C	Dim. D
1/2	.75	6.81	3.06	2.69	.88	6.81	3.06	2.69	1.00	9.19	3.06	2.69	.88	12.09	3.31	2.88
3/4	.88	6.81	3.06	2.69	.88	6.81	3.06	2.69	1.00	9.19	3.06	2.69	.88	12.09	3.31	2.88
1	1.00	7.03	3.06	2.69	1.00	7.03	3.06	2.69	1.00	9.19	3.06	2.69	1.00	12.31	3.31	2.88

PUSHBUTTON STATIONS

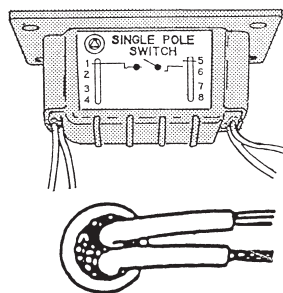
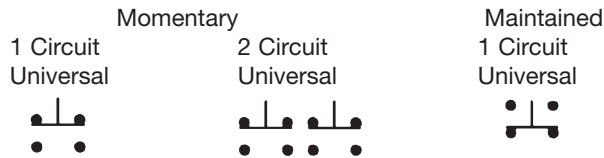

EDS snap switch (toggle) sealing well with wiring diagram.

Pilot lights and sealing wells are furnished with pigtail leads for field connection by use of wire nuts.

WARNING

Always disconnect primary power source before opening the enclosure for inspection or service.

1. Frequent inspection should be made. A schedule for maintenance checks should be determined by the environment and frequency of use. It is recommended that inspection should occur at least once a year.
2. Perform visual, electrical and mechanical checks on all components on a regular base.
3. Visually check for undue heating evidenced by discoloration of wires or other components, damaged or worn parts or leakage evidenced by water or corrosion in the interior.
4. Electrical check to make sure that all connections are clean and tight, and that contacts in the components make or break as required.
5. Mechanically check that all parts are properly assembled, and that operating mechanisms move freely.

Except as expressly provided by Appleton Grp, LLC (Appleton), Appleton products are intended for ultimate purchase by industrial users and for operation by persons trained and experienced in the use and maintenance of this equipment and not for consumers or consumer use. Appleton warranties DO NOT extend to, and no reseller is authorized to extend Appleton's warranties to any consumer.

While every precaution has been taken to ensure accuracy and completeness in this manual, Appleton Grp, LLC, assumes no responsibility, and disclaims all liability for damages resulting from use of this information or for any errors or omissions. Specifications are subject to change without notice. The Appleton and Emerson logos are registered in the U.S. Patent and Trademark Office. All other product or service names are the property of their registered owners.

©2017 Appleton Grp, LLC. All rights reserved.