



Industrial Specification Grade Plugs and Connectors

- 2 Pole, 3 Wire Grounding
- 3 Pole, 3 Wire Non-Grounding
- 4 Pole, 4 Wire Non-Grounding
- NEMA 5-15, 15A 125V
- NEMA 6-15, 15A 250V
- NEMA 5-20, 20A 125V
- NEMA 6-20, 20A 250V
- NEMA 7-20, 20A 277V
- NEMA 10-20, 20A 125/250V
- NEMA 18-20, 20A 120/280V 3Ø

Safety Grip™ Nylon Dead-Front Plugs and Connectors

FEATURES

- Nylon back-wired Dead-Front construction.
- Neoprene gasket seals cord hole opening.
- Dual range cord grip design.
- Combination head screws: U.S. Phillips/slotted; Can. Robertson/slotted.
- Add "-C" to catalog numbers for Canadian Screws.

Safety Grip™ Dead-Front Plugs and Connectors

Rating A	V/AC	NEMA	Description	Cord Diameter	Color	Catalog No.	
						Plug	Connector
15	125	5-15	Straight	0.250-0.656" (6.4-16.7mm)	Black & White	6266*	6269*
			Angle	0.300-0.656" (7.62-16.7mm)	Black & White	6265*	
15	250	6-15	Straight	0.250-0.656" (6.4-16.7mm)	Black & White	6666*	6669*
20	125	5-20	Straight	0.250-0.656" (6.4-16.7mm)	Black & White	6766	6769†
20	250	6-20	Straight	0.250-0.656" (6.4-16.7mm)	Black & White	6866	6869
20	277	7-20	Straight	0.375-1.000" (9.5-25.4mm)	Black & White	7624N	—
20	125/250	10-20	Straight	0.375-1.000" (9.5-25.4mm)	Black & White	9151N†	—
20	120/ 208V 3Ø	18-20	Straight	0.375-1.000" (9.5-25.4mm)	Black & White	7251N†	—

* Not Fed. Specs.

† Not CSA listed

INDUSTRIAL
COMMERCIAL
RESIDENTIAL

I-5 STRAIGHT BLADE PLUGS AND CONNECTORS

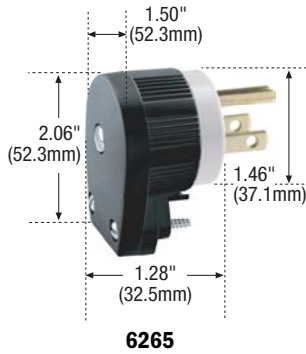

TESTING & CODE COMPLIANCE

- Listed to UL 498 (file no. E3663,)
- UL verified to Federal Spec. WC-596, except as noted.
- Listed to CSA, C22.2 no 42. (file no. LR7087), except as noted.

MATERIAL CHARACTERISTICS

Nylon.
Temperature Rating:
-40°C to 75°C.

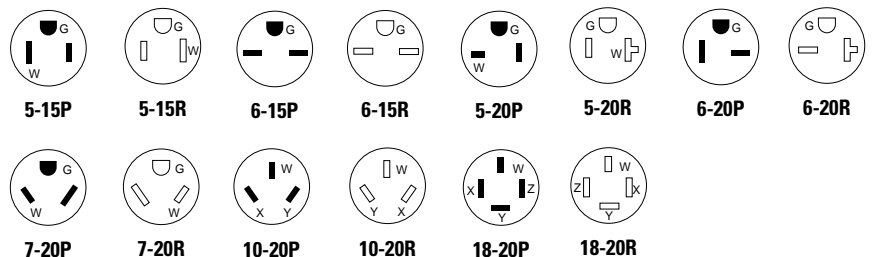

Industrial Specification Grade Plugs and Connectors

2 Pole, 3 Wire Grounding
 3 Pole, 4 Wire Grounding
 NEMA 5-15, 15A 125V
 NEMA 6-15, 15A 250V
 NEMA 5-20, 20A 125V
 NEMA 6-20, 20A 250V
 NEMA 14-20, 20A 125/250V,
 NEMA 15-20, 20A 250V 3Ø



AutoGrip™ Nylon Dead-Front Plugs and Connectors

FEATURES

- Neoprene gasket seals cord hole opening.
- Back wired Dead-Front design.
- All nylon construction reduces breakage and provides excellent chemical resistance.
- Automatic cord grip clamps the cord during assembly.
- Combination head screws: U.S. Phillips/slotted; Can. Robertson/slotted.
- Add "-C" to catalog numbers for Canadian Screws.

AutoGrip™ Dead-Front Plugs and Connectors

Rating		NEMA	Description	Cord Diameter	Color	Catalog No.	
A	V/AC					Plug	Connector
15	125	5-15	Straight	0.250-0.656" (6.4-16.7mm)	Black & White	5266N	5269N
			Straight Corrosion Resistant	0.250-0.656" (6.4-16.7mm)	Yellow	5266NCR	5269NCR
			Straight Isolated Ground	0.250-0.656" (6.4-16.7mm)	Orange	IG5266N	
15	250	6-15	Straight	0.250-0.656" (6.4-16.7mm)	Black & White	5666N	5669N
20	125	5-20	Straight	0.250-0.656" (6.4-16.7mm)	Black & White	5366N	5369N*
			Straight Corrosion Resistant	0.250-0.656" (6.4-16.7mm)	Yellow	5366NCR	5369NCR*
			Straight	0.250-0.656" (6.4-16.7mm)	Yellow	5366NY	5369NY*
20	250	6-20	Straight	0.250-0.656" (6.4-16.7mm)	Black & White	5466N	5469N*
20	125/250	14-20	Straight	0.625-1.125" (15.9-28.6mm)	Yellow	5757*†	
20	250V 3Ø	15-20	Straight	0.625-1.125" (15.9-28.6mm)	Yellow	5783*†	

*Not CSA listed
 †Not Federal Spec.



5-15P



5-15R



6-15P



6-15R



5-20P



5-20R



6-20P



6-20R



14-20P



14-20R



15-20P



15-20R



5266N



5269N

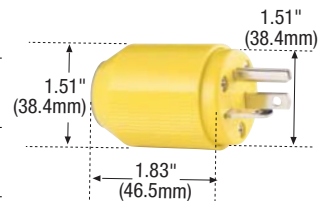

5366NCR

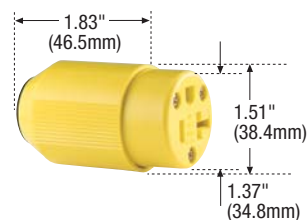

5369NCR

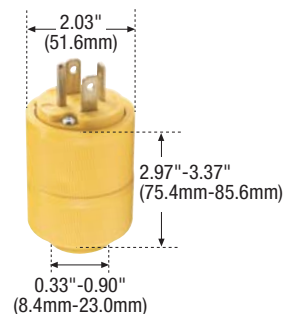

5757

INDUSTRIAL
 COMMERCIAL
 RESIDENTIAL

I-6 STRAIGHT BLADE PLUGS AND CONNECTORS

TESTING & CODE COMPLIANCE

- Listed to UL 498 (file no. E3663).
- Federal Spec. WC-596, except 5757 & 5783: (file no. E146159).
- CSA listed to C22.2 no 42. (file no. LR7087.)

MATERIAL CHARACTERISTICS

Nylon, except 5757 & 5783: ABS/PVC.
 Temperature Rating: -40°C to 75°C.



Industrial Specification Grade Plugs and Connectors

2 Pole, 3 Wire Grounding
 3 Pole, 3 Wire Non-Grounding
 NEMA 5-15, 15A 125V
 NEMA 5-20, 20A 125V
 NEMA 6-15, 15A 250V,
 NEMA 6-20, 20A 250V
 NEMA 10-20, 20A 125/250V

INDUSTRIAL
 COMMERCIAL
 RESIDENTIAL

I-7 STRAIGHT BLADE PLUGS AND CONNECTORS



5266

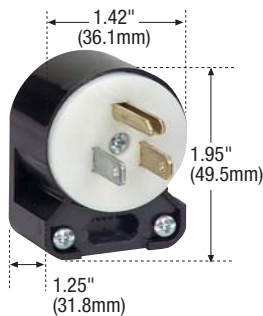

5266AN



5269

TESTING & CODE COMPLIANCE

- Listed to UL 498 (file no. E3663).
- UL verified to Federal Spec. WC-596 except as noted.
- CSA Certified to C22.2 no. 42. (file no. 2081 (6221-02)),
- NOM Certified.

MATERIAL CHARACTERISTICS

Polycarbonate and PVC.
 Environmental:
 Meets flammability requirements per UL 94, V2 rated.
 Temperature Rating:
 -40°C to 75°C.

Industrial Specification Grade Polycarbonate Plugs and Connectors

FEATURES

- High impact-resistant thermoplastic housings with easy-grip grooves.
- Assembly screws are speed-threaded and captive, reducing installation time.
- Solid brass plug blades are firmly embedded in body.
- See-through terminal cover allows inspection of connections.
- Terminals in individual chambers to positively insulate conductors.
- Clearly marked rating, NEMA configuration and standard compliances (third-party listing) on face of device.
- Terminal screws backed out - ready for wiring.
- Angle plugs have eight possible positions for maximum convenience.
- Combination slot/Phillips head mounting and terminal screws ease installation with power screwdrivers. (Slot/Robertson screws in Canada where available).

Industrial Specification Grade Polycarbonate Plugs and Connectors

Rating	Cord	Catalog No.				
A V/AC	NEMA	Description	Color	Plug	Connector	
15 125	5-15	Straight	0.25 -0.69" (6.4-17.5mm)	Black & White	5266	5269**
		Angle	0.25 -0.69" (6.4-17.5mm)	Black & White	5266AN**	
20 125	5-20	Straight	0.25 -0.69" (6.4-17.5mm)	Black & White	5366	5369**
		Angle	0.25 -0.69" (6.4-17.5mm)	Black & White	5366AN	
15 250	6-15	Straight	0.25 -0.69" (6.4-17.5mm)	Black & White	5666	5669**
		Angle	0.25 -0.69" (6.4-17.5mm)	Black & White	5666AN	
20 250	6-20	Straight	0.25 -0.69" (6.4-17.5mm)	Black & White	5466	5469**
		Angle	0.25 -0.69" (6.4-17.5mm)	Black & White	5466AN	
20 125/250	10-20	Straight	0.25 -0.69" (6.4-17.5mm)	Black & White	5236	

** Not Fed. Specs.

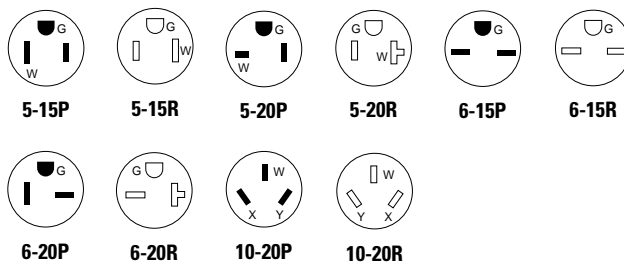

Industrial Specification Grade Plugs and Connectors

2 Pole, 3 Wire Grounding
 NEMA 5-15, 15A 125V
 NEMA 6-15, 15A 250V,
 NEMA 5-20, 20A 125V
 NEMA 6-20, 20A 250V



Quickeze™ Nylon Dead-Front Plugs

FEATURES

- Nylon backed-wired Dead-Front construction.
- Twist on cover eliminates assembly screws.
- All terminal screws located on same side for fast wiring.
- Automatic cord grip clamps the cord during assembly.
- Combination head screws: U.S. Phillips/slotted; Can. Robertson/slotted.
- Add "-C" to catalog numbers for Canadian Screws.

Quickeze™ Dead-Front Plugs

Rating		NEMA	Description	Cord Diameter	Color	Catalog No. Plug
A	V/AC					
15	125	5-15	Straight	0.250-0.656" (6.4-16.7mm)	Gray	5965V
			Straight Corrosion Resistant		Yellow	5965VCR
15	250	6-15	Straight	0.250-0.656" (6.4-16.7mm)	Gray	5666V
20	125	5-20	Straight	0.250-0.656" (6.4-16.7mm)	Gray	5364V
			Straight Corrosion Resistant		Yellow	5364VCR
20	250	6-20	Straight	0.250-0.656" (6.4-16.7mm)	Gray	5464V

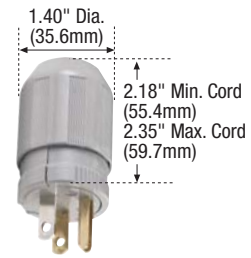

5965V

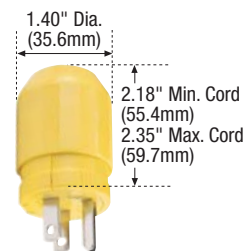

5965VCR

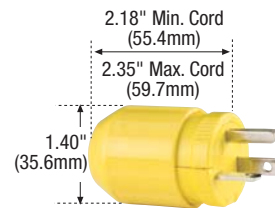

5364VCR

INDUSTRIAL
 COMMERCIAL
 RESIDENTIAL

I-8 STRAIGHT BLADE PLUGS AND CONNECTORS

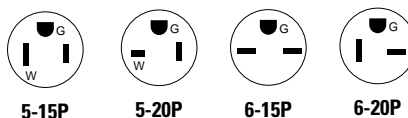

TESTING & CODE COMPLIANCE

- Listed to UL 498 (file no. E3663).
- Listed to CSA, C22.2 no. 42. (file no. LR7087).

MATERIAL CHARACTERISTICS

Nylon.
 Temperature Rating:
 -40°C to 95°C.



Industrial Specification Grade Plugs and Connectors

2 Pole, 3 Wire Grounding
 3 Pole, 3 Wire Non-Grounding
 NEMA 5-15, 15A 125V
 NEMA 6-15, 15A 250V,
 NEMA 5-20, 20A 125V
 NEMA 6-20, 20A 250V
 Non-NEMA 15/10A, 125/250V

INDUSTRIAL
 COMMERCIAL
 RESIDENTIAL

I-9 STRAIGHT BLADE PLUGS AND CONNECTORS

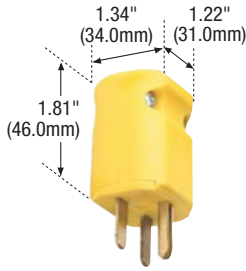

5666Y



5669Y

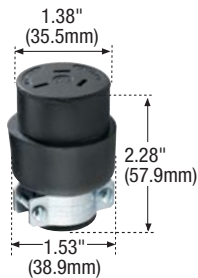

4472

TESTING & CODE COMPLIANCE

- Listed to UL 498 (file no. E146159).
- UL verified to Federal Spec. WC-596
- CSA certified to C22.2 no. 42, (file no. LR1765). (4475 and 4472 are not UL or CSA listed).

MATERIAL CHARACTERISTICS

Temperature Rating:
 -40°C to 75°C.

QuickGrip™ Dead-Front Plugs and Connectors

FEATURES

- One piece design and quick drive screws for fast wiring.
- High visibility yellow nylon for chemical and impact resistance.
- Combination head screws: Phillips/Robertson/slotted.
- UL verified to Federal Spec. WC-596F, CSA certified.

QuickGrip™ Dead-Front Plugs and Connectors

Rating A	V/AC	NEMA	Description	Cord Diameter	Color	Catalog No.	
						Plug	Connector
15	125	5-15	Straight	0.230-0.720" (5.8-18.3mm)	Yellow	5965Y	5969Y
			Straight	0.230-0.720" (5.8-18.3mm)	Black	5965BK	5969BK
15	250	6-15	Straight	0.230-0.720" (5.8-18.3mm)	Yellow	5666Y	5669Y
20	125	5-20	Straight	0.230-0.720" (5.8-18.3mm)	Yellow	5364Y	5369Y
20	250	6-20	Straight	0.230-0.720" (5.8-18.3mm)	Yellow	5464Y	5469Y

Rubber Dead-Front Plugs

Rating A	V/AC	NEMA	Description	Cord Diameter	Color	Catalog No.	
						Plug	Connector
15/10	125/250	Non-NEMA	Straight	0.560-.0650" (14.2-16.5mm)	Black	4475**	
				0.325-0.560" (8.3-14.2mm)	Black		4472**

** Not Fed. Specs.

