

KRN100 Series

100mm Hybrid Recorder

■ Features

- 100mm paper recorder
- Writable data logger function without paper (supports internal memory and external USB memory data backup)
- 25 to 250ms high speed sampling, 10 to 240mm/H high graph mode recording
- 6 kinds of recording color
- Easy parameter setting with quick menu
- Internal parameter setting and monitoring via USB, RS485, Ethernet communication
- High visibility and convenient setting with graphic LCD
- Various inputs of up to 12 channels with slot type input card
- Total 27 types of input specifications (weight, voltage, current, frequency, potentiometer, and various input card can be ordered)
- Reduced installation space with small size (rear length: 168mm)



 Please read "Safety Considerations" in the instruction manual before using.



■ Manuals

- The user manual includes product specifications, functions, and operations.
- The user manual for communication includes information about Modbus RTU protocol, Modbus TCP protocol, and Modbus mapping table.

■ Comprehensive Device Management Program (DAQMaster)

- DAQMaster is comprehensive device management program for convenient management of parameters and multiple device data monitoring.

< Computer specification for using software >

| Item | Minimum requirements |
|------------|--|
| System | IBM PC compatible computer with Intel Pentium III or above |
| Operations | Microsoft Windows 98/NT/XP/Vista/7/8/10 |
| Memory | 256MB+ |
| Hard disk | 1GB+ of available hard disk space |
| VGA | Resolution: 1024×768 or higher |
| Others | RS-232 serial port (9-pin), USB port |

< DAQMaster screen >



■ Ordering Information

■ Ordering information for recorder model

| | | | | | | | | | | | |
|---------------|---|-----------|----------|----------|----------|---|----------|----------|---|----------|----------|
| KRN100 | - | 12 | 0 | 0 | 0 | - | 0 | 0 | - | 0 | S |
| ① | | ② | ③ | ④ | ⑤ | | ⑥ | ⑦ | | ⑧ | ⑨ |

| Item | Description | |
|-----------------------------|-------------|----------------------------------|
| ① Item | KRN100 | 100mm Paper Type Recorder |
| ② Input channel | 02 | 2-channel (KRN-UI2 × 1) |
| | 04 | 4-channel (KRN-UI2 × 2) |
| | 06 | 6-channel (KRN-UI2 × 3) |
| | 08 | 8-channel (KRN-UI2 × 4) |
| | 10 | 10-channel (KRN-UI2 × 5) |
| | 12 | 12-channel (KRN-UI2 × 6) |
| ③ Digital inputs | 0 | None |
| | 1 | 6 (KRN-DI6 × 1) |
| | 2 | 12 (KRN-DI6 × 2) |
| ④ Alarm transistor outputs | 0 | None |
| | 1 | 6 (KRN-AT6 × 1) |
| | 2 | 12 (KRN-AT6 × 2) |
| ⑤ Alarm relay outputs | 0 | None |
| | 1 | 4 (KRN-AR4 × 1) |
| | 2 | 8 (KRN-AR4 × 2) |
| | 3 | 12 (KRN-AR4 × 3) |
| ⑥ Transmitter power outputs | 0 | None |
| | 1 | 3 (KRN-24V3 × 1) |
| | 2 | 6 (KRN-24V3 × 2) |
| | 3 | 9 (KRN-24V3 × 3) |
| | 4 | 12 (KRN-24V3 × 4) |
| ⑦ Communication output | 0 | None |
| | 1 | RS485/Ethernet/USB (KRN-COM × 1) |
| ⑧ Power voltage | 0 | 100-240VAC 50/60Hz |
| ⑨ Case | S | Standard panel mounting type |

■ Ordering information for input/output card

| Type | Model | Function and number of channels | Max. mountable cards | Slot number |
|-------------------------------|----------|---|----------------------|-----------------------|
| Universal input card | KRN-UI2 | Universal input 2-channel | 6 | 1 to 6 |
| Digital input card | KRN-DI6 | Digital input 6-channel | 2 | 7 to 10 ^{※1} |
| Alarm output card | KRN-AR4 | Alarm relay output 4-channel | 3 | |
| | KRN-AT6 | Alarm transistor output 6-channel | 2 | |
| Transmitter power output card | KRN-24V3 | Transmitter 24VDC power output 3-channel | 4 | |
| Communication output card | KRN-COM | RS485 + USB + Ethernet communication output | 1 | C |

※ 1. The digital input card, alarm output card, transmitter power output card are connectable up to 4 cards as mixed.

■ Example of ordering

To use universal input 10-channel, digital input 4-channel, alarm relay output 5-channel, and RS485 communication output, it is ordered as KRN100-10102-01-0S and the connected I/O card is as below.

- KRN100 (recorder): 1
- KRN-UI2 (universal input card): 5 (One universal input card is 2-channel and 5 cards × 2-channel = 10-channel.)
- KRN-DI6 (digital input card): 1
- KRN-AR4 (alarm relay output card): 2
- KRN-COM (communication output card): 1

KRN100 Series

■ Specifications

| | | |
|---|--|---|
| Series | KRN100 | |
| Power voltage | 100-240VAC~ 50/60Hz | |
| Allowable voltage range | 85 to 110% of rated voltage | |
| Power consumption | Max. 55VA | |
| Screen | LCD type | STN Graphic LCD |
| | Resolution | 320 × 120Pixel |
| | Adjusting brightness | 4-level (OFF/Min/Standard/Max) |
| | Backlight | White LED, 2-level (Temp/Always) |
| Input channels | 2 / 4 / 6 / 8 / 10 / 12-channel (2-channel/card) | |
| Universal input* ¹ | Temperature sensor (RTD, thermocouple), analog (voltage, current) | |
| Sampling period | 1 to 4-channel: 25ms/125ms/250ms, 5 to 12-channel: 125ms/250ms (inner sampling period is operation unit time for average movement filter and alarm output function.) ※Min. sampling period for TC-R, U, S, T sensor is 50ms. | |
| Recording speed in graph mode | 10, 20, 40, 60, 120, 240mm/H | |
| Recording speed accuracy | F.S. ±0.5% | |
| Storage cycle | 1 to 3600 sec (storage interval time to inner log file is 1 sec) | |
| Inner memory | 512MB | |
| USB memory* ² | Recognizes max. 32GB, enables to use cable up to 1.5m | |
| Dielectric voltage | 2500VAC 50/60Hz for 1 min (power terminal and case) ※Excepts USB Device and Ethernet | |
| Vibration strength (for convey and storage) and operating vibration | Vibration strength: 10 to 60Hz 4.9m/s ² (each X, Y, Z axis for 1 hour) Operating vibration: 10 to 60Hz 1m/s ² (each X, Y, Z axis for 10 min) | |
| Insulated resistance | Over 20MΩ (at 500VDC megger) | |
| Noise immunity | ±2kV the square wave noise (pulse width 1μs) by the noise simulator | |
| Time accuracy | Within ±2 min/year (enables to use up to 2100 year) | |
| Mech- anism | Ink cartridge | Enables to normal print with going and returning printing max. 5 times within 7 days after opening the unit |
| | Ink dry time | Max. 15 minutes |
| Protection | IP40 (for front panel) | |
| Recording paper | 113mm × 9m | |
| Environ- ment | Ambient temperature | 0 to 50°C, storage: -20 to 60°C (without ink cartridge) |
| | Ambient humidity | 35 to 85%RH, storage: 35 to 85%RH |
| Approval | CE  | |
| Weight* ³ | Approx. 2.4 to 2.7kg (approx. 1.7 to 2.0kg) | |

※ 1. For more information of universal input, please refer to 「I/O card」.

※ 2. This is included in the product. In case of using the USB flash drive that the user purchased, the device may not be supported.

※ 3. The weight includes packaging. The weight in parenthesis is for unit only.

※ Environment resistance is rated at no freezing or condensation.

100mm Hybrid Recorder

■ I/O card

| Type | Model | I/O specifications | | Descriptions |
|---|----------|--------------------------------|--------------------------|--|
| Universal input card | KRN-UI2 | Input type ^{※1} | RTD | JPt100Ω, DPt100Ω, DPt50Ω, Cu100Ω, Cu50Ω (supply current 420μA) |
| | | | Thermocouple | B, C (W5), E, G, J, K, L, L (Russia), N, P, R, S, T, U |
| | | | Analog | Voltage: ±60mV ±200mV ±2V, 1-5V, ±5V, -1V-10V Current: 0.00-20.00mA, 4.00-20.00mA |
| | | Input impedance | | Voltage (V): min. 150kΩ RTD, Thermocouple, Voltage (mV): min. 2MΩ Current: 51Ω |
| | | Display accuracy ^{※2} | RTD | Warm-up time: min. 30 min Room temperature (25°C±5°C): ±0.1%F.S ±1digit Out of room temperature range: ±0.2%F.S ±1digit For RTD, 500 to 800°C is ±0.5%±1digit of PV value, For Thermocouple, below -100°C is ±0.3%F.S.±1digit. |
| | | | Thermocouple | |
| Analog | | | | |
| Resolution | | 16bit | | |
| Digital input card | KRN-DI6 | Non-contact input | | ON: max. 1V of residual voltage, OFF: max. 0.1mA of leakage current |
| | | Contact input | | ON: max. 1kΩ, OFF: min. 100kΩ, Outflow current for short: approx. 4mA |
| Alarm output card | KRN-AR4 | Alarm relay output | Capacity | 250VAC~ 3A, 30VDC= 3A, 1 Form A (resistance load) |
| | | | Life | Mechanical: min. 50,000,000 operations Electrical: min. 100,000 operations (250VAC~ 3A, 30VDC= 3A) |
| | KRN-AT6 | Alarm transistor output | | NPN open collector, 12-24VDC/30mA Max. |
| Transmitter power output card | KRN-24V3 | Transmitter power output | | 24±2VDC=, total 3 channels, max. 30mA per 1 channel built-in over-current protection circuit |
| Communication output card ^{※3} | KRN-COM | Com. output | RS485 | Modbus RTU ※Recommended to use shield cable over AWG24 |
| | | | EtherNet | IEEE802.3 (U), 10/100 BASE-T (Modbus TCP) |
| | | | USB Device ^{※4} | USB V2.0 Full Speed (Device Control) |

※1. To change input specification, you must turn OFF the power of KRN100, remove universal input cards, set inner jumper pins (please refer to 'I/O card') and re-connect it.

※2. Exception range for measuring accuracy by each sensor (accuracy after 30 min warm-up time)

- R,S,C,G: 0≤T≤100±4.0°C
- B: No regulation accuracy below 400°C
- U,T: -200≤T≤-100±3.0°C, -100≤T≤400±2.0°C
- Cu50: -200≤T≤200±1.0°C
- DPt50: -200≤T≤600±1.5°C

※3. RS485, Ethernet communication output are not available at the same time.

※4. The front USB device is only for data backup and rear USB device is available only for parameter setting.

※ It is recommended to use shield cable to decrease noise when sensor input cable is longer.

※ **If connecting or disconnecting input/output card when power is ON, it may cause malfunction.**

To connect or disconnect input/output card, you must turn OFF the power.

KRN100 Series

Input Type and Range

| Input type | | Display | Input range | | |
|--------------|--------------------------------|--------------------|------------------|------------------|---|
| | | | °C | °F | K |
| Thermocouple | K (CA) | TC-K | -200.0 to 1350.0 | -328.0 to 2462.0 | 73.2 to 1623.2 |
| | J (IC) | TC-J | -200.0 to 800.0 | -328.0 to 1472.0 | 73.2 to 1073.2 |
| | E (CR) | TC-E | -200.0 to 800.0 | -328.0 to 1472.0 | 73.2 to 1073.2 |
| | T (CC) | TC-T | -200.0 to 400.0 | -328.0 to 752.0 | 73.2 to 673.2 |
| | B (PR) | TC-B | 100.0 to 1800.0 | 212.0 to 3272.0 | 373.2 to 2073.2 |
| | R (PR) | TC-R | 0.0 to 1750.0 | 32.0 to 3182.0 | 273.2 to 2023.2 |
| | S (PR) | TC-S | 0.0 to 1750.0 | 32.0 to 3182.0 | 273.2 to 2023.2 |
| | N (NN) | TC-N | -200.0 to 1300.0 | -328.0 to 2372.0 | 73.2 to 2023.2 |
| | C (TT) ^{※1} | TC-C | 0.0 to 2300.0 | 32.0 to 4172.0 | 273.2 to 2573.2 |
| | G (TT) ^{※2} | TC-G | 0.0 to 2300.0 | 32.0 to 4172.0 | 273.2 to 2573.2 |
| | L (IC) | TC-L | -200.0 to 900.0 | -328.0 to 1652.0 | 73.2 to 1173.2 |
| | L (Russian type) ^{※3} | TC-L_R | 0 to 600.0 | 32.0 to 1112.0 | 273.2 to 873.2 |
| | U (CC) | TC-U | -200.0 to 400.0 | -328.0 to 752.0 | 73.2 to 673.2 |
| Platinel II | TC-P | 0.0 to 1350.0 | 32.0 to 2462.0 | 273.2 to 1623.2 | |
| RTD | Cu50Ω | CU50 | -200.0 to 200.0 | -328.0 to 392.0 | 73.2 to 473.2 |
| | Cu100Ω | CU100 | -200.0 to 200.0 | -328.0 to 392.0 | 73.2 to 473.2 |
| | JPt100Ω | JPT100 | -200.0 to 600.0 | -328.0 to 1112.0 | 73.2 to 873.2 |
| | DPT50Ω | DPT50 | -200.0 to 600.0 | -328.0 to 1112.0 | 73.2 to 873.2 |
| | DPT100Ω | DPT100 | -200.0 to 850.0 | -328.0 to 1562.0 | 73.2 to 1123.2 |
| Analog | Voltage | -60.00 - 60.00mV | ±60mV | Resolution: 10μV | -99999 to 99999 (display range depends on the decimal point position) |
| | | -200.00 - 200.00mV | ±200mV | Resolution: 10μV | |
| | | -2.000 - 2.000V | ±2V | Resolution: 1mV | |
| | | 1.000 - 5.000V | 1-5V | Resolution: 1mV | |
| | | -5.000 - 5.000V | ±5V | Resolution: 1mV | |
| | | -1.00 - 10.00V | -1V-10V | Resolution: 10mV | |
| | Current | 0.00 - 20.00mA | 0-20mA | Resolution: 10μA | |
| | | 4.00 - 20.00mA | 4-20mA | Resolution: 10μA | |

※ 1. C (TT): Same as existing W5 (TT) type sensor

※ 2. G (TT): Same as existing W (TT) type sensor

※ 3. Russian type L type temperature sensor is divided from general purpose L type.

※ **When changing input type to voltage (over ±2V) or current, set the jumper pin of KRN-UI2 (universal input card). Its factory default is temperature sensor input.**

■ Connections

■ Rear side of KRN100 standard model

This figure is the rear side of KRN100-04000-00-0S.

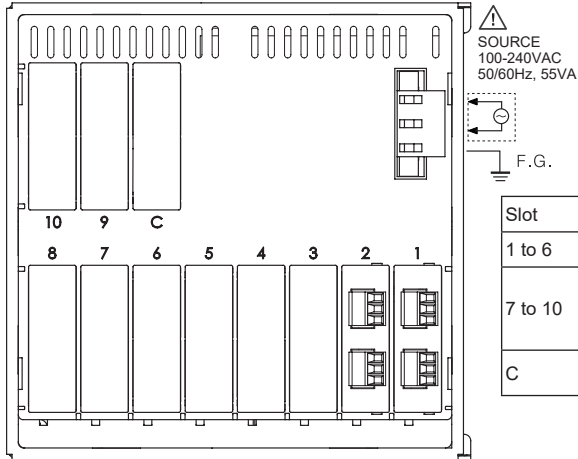

| Slot | Description |
|---------|--|
| 1 to 6 | Connects universal input card (KRN-UI2). |
| 7 to 10 | Connects digital input card (KRN-DI6), alarm output card (KRN-AR4, KRN-AT6), transmitter power output card (KRN-24V3). |
| C | Connects communication output card (KRN-COM). |

■ I/O card

| | |
|--|---|
| <p>Universal input card [KRN-UI2]</p> <p>※Each channel is isolated and dielectric strength is 500V.</p> | <p>Digital input card [KRN-DI6]</p> |
| <p>Alarm output card [KRN-AR4 (relay output)]</p> | <p>Alarm output card [KRN-AT6 (transistor output)]</p> <p>※AL1,2,3 and AL4,5,6 are isolated.</p> |
| <p>Transmitter power output card [KRN-24V3]</p> <p>※Each 24V output is isolated individually.</p> | <p>Communication output card [KRN-COM]</p> |

KRN100 Series

■ Dimensions

(unit: mm)

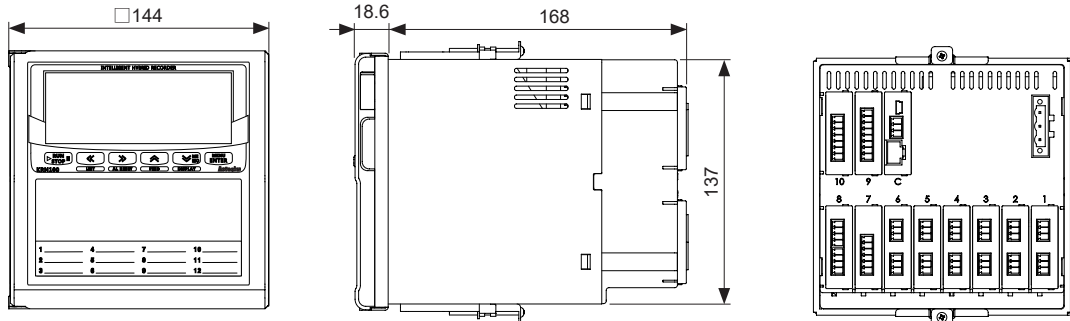

● Panel cut-out

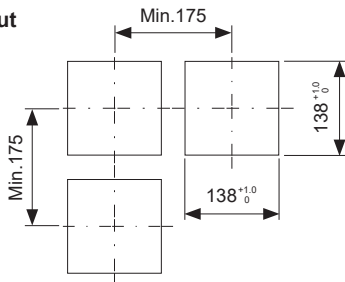

※ Use a steel plate which is 2 to 8mm thickness.

※ This rear side dimension is with installed I/O cards to every slot.

■ Unit Descriptions

■ Front and side part

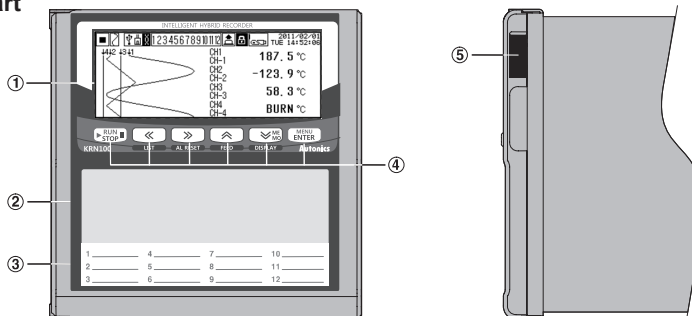

- ① Display part: Displays measurement values as trend graph, bar graph, or digital number (1/8/12-channel). Please refer to 「Display changing」.
- ② Recording print part: Records measuring value of data by each channel with designated color.
- ③ Channel information part: Write the information by each channel.
- ④ Control key/Function key: Executes parameter setting and recording, and special function.

| Key | Function |
|-----|--|
| | Used for starting/stopping recording, changing input characters on virtual keyboard status, and displaying Function key. Press this key for 3 sec in stop state, the ink cartridge moves to the center. (Use this key to replace the ink cartridge.) |
| | Used for going out from parameter setting group or setting manual channel switch mode. It also executes to release auto channel switch mode and printer list output (3 sec) function. |
| | Used for moving parameter in setting mode, setting manual channel switch mode and forced alarm reset (3 sec). |
| | Used for moving parameter in setting mode, increasing digit value, setting auto channel switch mode, and manual feed function (by pressing over 3 sec) in stop state. |
| | Used for moving parameter in setting mode, decreasing digit value, changing display mode and executing manual digital memo (3 sec) in recording state. |
| | Used for entering setting mode (3 sec) and set value change mode. |

100mm Hybrid Recorder

- ⑤ USB port :Connects an USB memory. It recognizes max. 32GB and if using cable, it is available up to 1.5m.

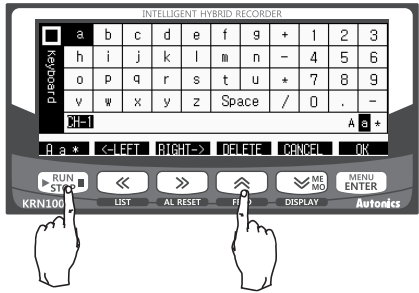

※Function key:

Use this key to enter virtual keyboard in parameter setting.

Press the **RUN STOP** key and Function key appears on lower screen as below figure. Press the **LEFT**, **RIGHT**, **DELETE**, **CANCEL**, **OK** key as below Function key, it operates the appropriate Function key's operation.



■ Rear part

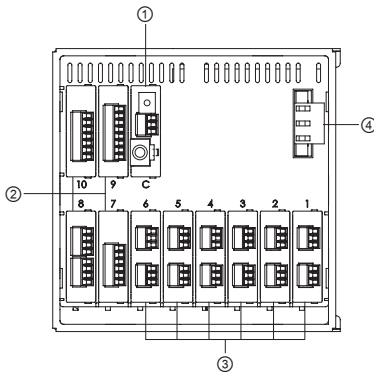

- ① Slot (C) for connecting communication output card (KRN-COM)
 ② Slot (7to10) for connecting digital input card (KRN-DI6), alarm relay output card (KRN-AR4), alarm transistor output card (KRN-AT6), transmitter power output card (KRN-24V3).

You can connect total 4 cards by combining digital input card, alarm output card, and transmitter power output card, as below combination example.

| | | | | | | | | |
|----------------|---|-----------------|---|----------------|---|-----------------|---|----------|
| KRN-DI6 : 1 | + | KRN-AR4 : 1 | + | KRN-AT6 : 1 | + | KRN-24V3 : 1 | = | Total: 4 |
| KRN-DI6 : 2 | + | KRN-AR4 : 1 | + | KRN-AT6 : 1 | = | Total: 4 | | |
| KRN-DI6 : 1 | + | KRN-24V3 : 3 | = | Total: 4 | | | | |

- ③ Slot (1 to 6) for connecting universal input card (KRN-UI2)
 ④ Power connecting part (100-240VAC 50/60Hz)

※Above the rear side image is connected every output card to help your understand.

■ Inside

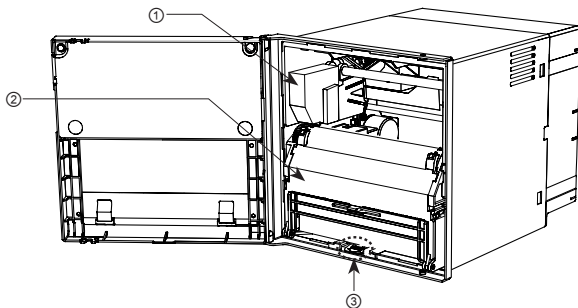

- ① Ink cartridge (model: D33006B-66X-01)
 ② Recording paper cassette
 Cassette saves the recording paper.
 ③ Recording paper cassette lever
 Press the lever down and this recording paper cassette is removed from KRN100.
 ※ Remove the recording paper cassette for recording paper replacement, ink cartridge replacement.

■ Paper cassette

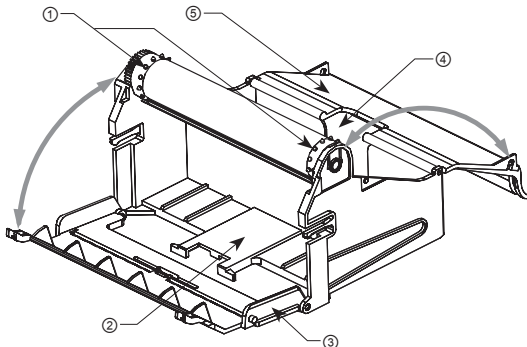

- ① Recording paper holder
 Movement holder of recording paper when recording
 ② Recording paper storage part
 Storage part for recorded recording paper
 ③ Front cover of recording paper storage
 Open recording paper guide for recording paper replacement
 ④ New recording paper storage: Storage part for new recording paper (1 recording paper is storable.)
 ⑤ Rear cover of recording paper storage

■ Functions

■ Special function [Special Function]

It displays the applied measuring value of the set special function. Depending on Input Type (Input specification), applied special function is different.

- Setting range:
 - When input type (input specification) is temperature sensor (thermocouple, RTD): None ↔ Difference
 - When input type (input specification) is analog (voltage, current): Linear ↔ Root ↔ Square ↔ Two Unit (Two Unit is displayed when Input Type (input specification) is set as 0-20mA, 4-20mA.)
- Factory default: None

◎ Difference (deviation)

It is available to set when Input Type (input specification) is temperature sensor (thermocouple, RTD). It displays the deviation of Reference Channel (Reference channel) measuring value.

(Display value = standard channel measuring value - reference channel measuring value)

- The set channel as analog (current, voltage) of Input Type (Input specification) is not able to set as Reference Channel (reference channel).
- If there is no set reference channel, it displays standard channel measuring value.
- If any one of reference channel, or standard channel is break (BURN), upper limit value (HHHH), lower limit value (LLLL) status, it displays as correspond value. If you select the channel which is used Difference function as reference channel, it displays the value based on calculating actual measuring value, not display value of reference channel.

◎ Linear

It applies lower limit scale and upper limit scale to lower limit input value and upper limit input value and displays this values.

E.g.) In case low limit input value: -5V, high limit input value: +5V and in case lower limit scale: -1000, upper limit scale: 1000, if current input value is 2V, display value is 400.

◎ Root

In case voltage, current input type, this mode is used when input value is calculated by Root ($\sqrt{\quad}$) for the desired display value. Differential pressure signal of differential pressure flow meter is calculated Root ($\sqrt{\quad}$) for the to-be measured flux. This function is used to measure flux by input value.

E.g.) In case lower limit input value: -5V, upper limit input value: +5V and in case lower limit scale: -1000, upper limit scale: 1000, if current input value is 2V, display value is approx. 673.32.

◎ Square

In case of voltage, current input type, this mode is used when input value is calculated by square for the desired display value. Reverse of Root, flux signal is calculated by square for differential pressure signal.

E.g.) In case lower limit range: -5V, upper limit range: +5V and in case lower limit scale: -1000, upper limit scale: 1000, if current input value is 2V, display value is -20.

◎ Two Unit

For compound pressure, if input pressure is lower than atmospheric pressure (0), it displays the degree of a vacuum with mmHg unit. If input pressure is higher than or same as atmospheric pressure (0), it displays positive pressure with kg/cm² unit.

When using Two Unit function, lower limit value is fixed as -760mmHg and kg/cm² value is able to set within setting range 1 to 35.

Two Unit limits scale point as 0 ↔ 0.0 ↔ 0.00 . When using Two Unit, display unit is automatically changed as mmHg or kg/cm².

The calculation with Record Method (Data storage method) and Filter type (Input digital filter) is impossible and ignored due to different type of two unit value.

- Setting range: 1 to 35
- Factory default: -

E.g.) If pressure range is -760mmHg to 3kg/cm², and pressure transmitter outputs 4-20mA, for 4mA input it displays -760mmHg, 8mA input is unit changing point. For 20mA input, it displays 3kg/cm².

■ Record zone division [Divide Zone]

Divides record zone for measuring value by channel.

It divides equally max. 12 zones as equal value. User needs to set record zone by channel in Record Zone setting at Input Setup.

It is easy to check measuring value due not to duplicated record zone with divided record zone by channel which is set in Record Zone setting at Input Setup.

If there is too many division for record zone, record value check accuracy is low.

- Setting range: None, 2 to 12
- Factory default: None

E.g.) SV of record zone division: None

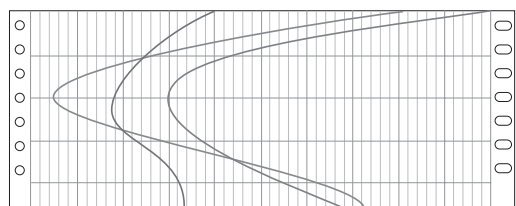

E.g.) SV of record zone division: 5

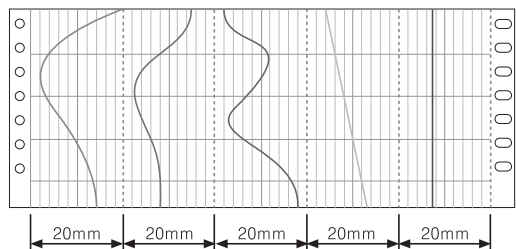

■ Functions

■ Summer time [Summer Time]

This function is for applying summer time (daylight saving time) in specific countries and regions.

When you set Summer Time, it adds current time and 1 hour and displays the 「(S)」 mark in front of the date and time on LCD screen or in front of the date on recording paper.

- Setting range: Disable ↔ Enable
- Factory default: Disable

■ Standard record period [Standard Period]

Set record period to record current time, display value by channel as digital number on recording paper.

It is activated when Record Mode (Record mode) is Digital.

- Setting range: 00m 01s to 99m 59s

Depending on the number of recording channels, min. setting range is limited as below.

| Record channel | Setting range |
|----------------|--------------------|
| 1 to 2 | 01m 00s to 99m 59s |
| 3 to 4 | 02m 00s to 99m 59s |
| 5 to 6 | 03m 00s to 99m 59s |
| 7 to 8 | 04m 00s to 99m 59s |
| 9 to 10 | 05m 00s to 99m 59s |
| 11 to 12 | 06m 00s to 99m 59s |

- Factory default: -

■ Reservation record [RESERVATION SETUP]

This function is to set reservation time. At the set time, it starts/stops recording automatically.

You can select reservation record either Repeat (repeat ON/OFF) or Single (single ON/OFF).

When selecting reservation record, 'Reservation Period (Reservation record period)' and 'Reservation Time (Reservation record time)' are activated. When reservation record is set, the **RE** icon flashes with the **▶** (recording) or the **■** (stop recording) icon.

The **RE** icon turns OFF when reservation setting is 'Disable'.

- Setting range: Disable ↔ Repeat ↔ Single
- Factory default: Disable

◎ Repeat (repeat ON/OFF)

From start recording date to end recording date, it records data at from the set start time to the set end time.

◎ Single (single ON/OFF)

Starts recording at the start set time on start date and finishes recording at the end set time on end date.

■ File/Memory setup [FILE/MEMORY SETUP]

You can set the parameter about parameter set file and storage data. Move to FILE/MEMORY SETUP with the **↑** (FEED) and **↓** (DISPLAY) keys, press the **ENTER** key to enter FILE/MEMORY SETUP.

◎ Open parameter set file [Load Set File]

Applies set value of saved parameter set file.

When applying this set, backup data, user unit and booting logo are not changed.

None, Default.pms file is activated and if there is User1.pms to User5.pms, User1.pms (USB) to User5.pms (USB) file (parameter set save file), it is activated.

- Setting range:
 - None ↔ Default.pms ↔ User1.pms to User5.pms ↔ User1.pms (USB) to User5.pms (USB)
- Factory default: None

※ Be sure that if selecting 'Default.pms' file, every set value is initialized as factory default. Save the current set parameter as Save Set File (parameter setting file storage) at first and initialize it for the provision.

※ One file from User1.pms to User5.pms, User1.pms (USB) to User5.pms (USB) is selected, all parameter setting information of KRN100 is changed as the set value of the selected parameter save file.

※ Set value changing may be also affected to every setting of KRN100's overall operations. Check possible problems occurring on system and change the desired set value.

◎ Save parameter set file [Save Set File]

Saves current set parameter set value to inner memory or an external USB memory.

When saving it to inner memory, it is saved in User1.pms to User5.pms files or to an external USB memory, it is saved in User1.pms (USB) to User5.pms (USB) files. (Activated only when an external USB memory is connected.)

- Setting range:
 - None ↔ User1.pms to User5.pms, User1.pms (USB) to User5.pms (USB)
- Factory default: Select...

■ Functions

◎ USB storage function [USB LogData Save]

Set whether to save backup data which is saved at system on an USB memory.

When selecting Enable to saving data to USB memory, it also saves data to system memory at the same time. Connected an USB memory at left side USB Slot, KRN100 starts to save. It takes check time for storage free space approx. 10 to 60 sec depending on memory capacity.

The data is saved as 'KRN100_20100815 (year month day)_091050 (hour min sec).KRD' file name and if main set is changed or backup data capacity is over 100MByte, it creates a new file.

- Setting range: Disable ↔ Enable
- Factory default: Disable
- ※ Supporting file system is FAT16, FAT32 when using an USB memory. Microsoft's file system, NTFS, and Linux's file system, EXT2, EXT3, etc., are not supportable.
- ※ When connecting an USB memory, KRN100 pauses backup data download by Modbus function, and backup data printer function to recognize memory for a while (depending on the capacity, max. 30 sec).
- ※ If an USB memory's LED flashes, do not remove an USB memory, or it may damage to the data. If the damage of USB memory data occurs, you can find the saved data from KRN100 inner memory and save the desired file to an USB memory.

■ Firmware upgrade

Upgrades KRN100 firmware.

When upgrading firmware, parameters' set values are initialized.

- Setting range: -
- Factory default: Auto set
- ※ During firmware upgrade, alarm output, digital input and log file save, etc functions does not operate normally. Therefore, please take proper measures to prevent malfunction of KRN100 system before starting firmware upgrade. After completing firmware upgrade, you must turn OFF and ON the power of KRN100 to operate normally.
- ※ During firmware upgrading, when power turns OFF, firmware upgrade is not complete. When power turns ON again, KRN100 operates with previous firmware version. Try firmware upgrade again.
- ※ After completing firmware upgrade and OFF/ON the power, if KRN100 displays booting screen and does not operate normally, it may have damage to the inner firmware during firmware upgrade. It is required to repair



■ Backup data record setting

[RECORD BACKUP SETUP]

Record Backup creates file when power ON regardless of starting/stopping record and saves the data to inner system memory (USB memory storage is available (Enable) by the set.) according the set record mode.

This parameter is useful to print the desired time data with backup data or check data by computer with DAQ Master (dedicated software).

Therefore, backup data set function is for printing the saved backup data at inner system memory and USB memory.

Move to RECORD BACKUP SETUP with the   keys and press the  key to enter RECORD BACKUP SETUP.

- ※ For printing backup data, KRN100 reads saved backup data in memory from beginning to end at first and starts printing. If backup data section is long or backup data is saved as low speed record mode, reading takes a lot of time. Therefore, print only for the desired section.
- ※ In graph mode, record speed is changed by Standard speed, Alarm, or Option Speed. Backup data is printed with Standard speed. Therefore, original printout and backup printout in graph mode may be different.

◎ Backup data record for clearing no recording paper [P.END Backup Print]

If there is no recording paper, the  icon flashes. After replacing recording paper, 「P.END BACKUP PRINT」 screen as below is activated.

Backup data recording function by P.END is same as RECORD BACKUP. Backup Data List cannot be changed.

Starting print by P.END Backup, it prints the data but backup data file date, file name, and backup record starting line.

■ Functions

■ Error

Displays error messages on screen and print data when error occurs.

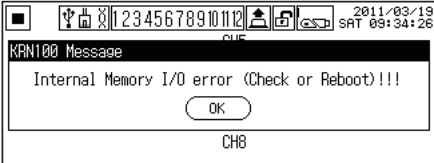
| Message | Description | Message | Description |
|---------|---|---------------------------|--|
| HHHH | In case Input Type is temperature sensor(thermocouple, RTD), if input value is higher than upper limit range, this error message flashes. If input value is within upper limit range, it is removed automatically. In case Input Type is analog (current, voltage), if input value is higher than over 10% of upper limit input range, this error message flashes. If input value is within 10% of upper limit input range, it is removed automatically. Prints HH. | LLLL | In case Input Type is temperature sensor (thermocouple, RTD), if input value is lower than lower limit range, this error message flashes. If input value is within lower limit range, it is removed automatically. In case Input Type is analog (current, voltage), if input value is lower than over 10% of lower limit input range, this error message flashes. If input value is within 10% of lower limit input range, it is removed automatically. Prints LL. |
| _H | In case Input Type is analog (current, voltage), if input value is higher than below 10% of upper limit input range, 「_H」 is displayed with current value to notify that current value is higher than upper limit input range. E.g.) When upper limit input range is 100 and current value is 102, it displays as 102_H. | _L | In case Input Type is analog (current, voltage), if input value is lower than below 10% of lower limit input range, 「_L」 is displayed with current value to notify that current value is lower than lower limit input range. E.g.) When lower limit input range is 0 and current value is -1, it displays as -1_L. |
| BURN | If input is break, this error message flashes. When input is connected, it is removed automatically. Prints BH (display value by break is High) or BL (display value by break is Low). | Inner Memory Access |  <p>As above screen, if excess error message for inner system memory Read/Write occurs frequently, please contact our service center.</p> |
| NONE | If universal input card is not connected, this error message flashes. | | |
| ERR | When there is parameter setting error, card recognition error, etc, this error message flashes twice and KRN100 returns to previous screen. | | |

※ For more functions, refer to the user manual of KRN100.

KRN100 Series

■ Functions



■ Communication setting [COMMUNICATION SETUP]

Set the related parameters with communication output card (KRN-COM).

You can only check the item of COMMUNICATION SETUP by communication but cannot change the set.

This parameter is for setting and monitoring parameters from external upper system (PC and graph panel, etc) or transmitting the data to external devices by RS485, Ethernet, or USB Device communication.

It is recommended to use our dedicated software program DAQMaster for monitoring. If you want to develop monitoring program not using our DAQMaster program or to use the related Modbus program, please refer to user manual for communication.

Move to COMMUNICATION SETUP with the   keys, press the  key to enter COMMUNICATION SETUP.

KRN100 does not supports RS485 port, Ethernet port at the same time for preventing system overload. If you change one as 「Enable」, the other is changed 「Disable」 automatically.

In case USB Device, it is able to set 「Enable」, 「Disable」 regardless of RS485 or Ethernet setting.

◎ Interface

| Item | RS485 | Ethernet | USB |
|-----------------------------|------------------------------------|---|--------------------------|
| Application standard | Compliance with EIA RS485 | — | Compliance with USB V2.0 |
| Max. connections | 31 units (address: 1 to 127) | 1 unit (number of occup a ions per a unit) | 1 unit |
| Com. distance ^{※1} | Within max. 1km (below 9600bps) | Single cable within 100m (recommended over CAT5E) | Single cable within 1.5m |
| Com. method | Half duplex | Full duplex | — |
| Com. synchronization method | Asynchronous | Asynchronous | Asynchronous |
| Com. speed | 2400/4800/9600/19200/38400bps | 10/100Mbps | 12Mbps (Full Speed) |
| Com. response wait time | 5 to 99ms | — | — |
| Start Bit | 1bit (fixed) | — | — |
| Data Bit | 8bit (fixed) | — | — |
| Parity Bit | None, Odd, Even | — | — |
| Stop Bit | 1, 2bit | — | — |
| Protocol | Modbus RTU | Modbus TCP | Modbus RTU |

※1. When connecting through the network such as network hub (HUB) and gateway, etc, there is no distance limit, but it is recommended to use min. network. Please use communication cables which is satisfied the below conditions.

- RS485 communication: Shield Twist Pair over AWG24, characteristic impedance 100Ω, capacity component 50 pF/m cable length max. 1km
- Ethernet communication: Over CAT5E, cable max. length: 100m
- USB communication: Single cable built-in ferrite core within 1.5m

◎ Application of system organization

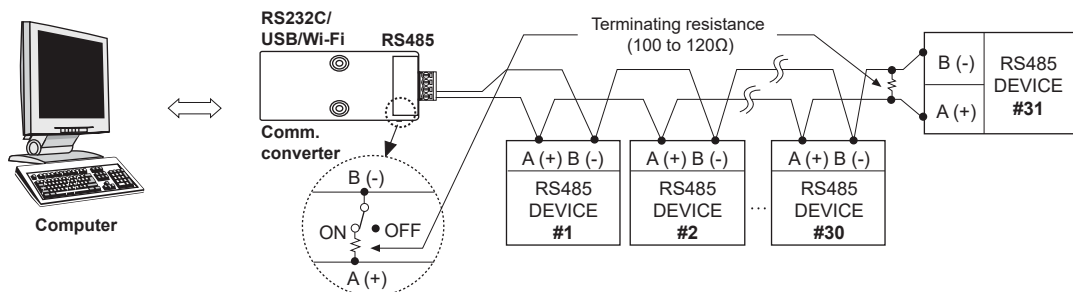

※It is recommended to use Autonics communication converter; SCM-WF48 (Wi-Fi to RS485-USB wireless communication converter, sold separately), SCM-US48I (USB to RS485 converter, sold separately), SCM-38I (RS232C to RS485 converter, sold separately). Please use twisted pair wire, which is suitable for RS485 communication, for SCM-WF48 and SCM-US48I.

100mm Hybrid Recorder

Adjustment

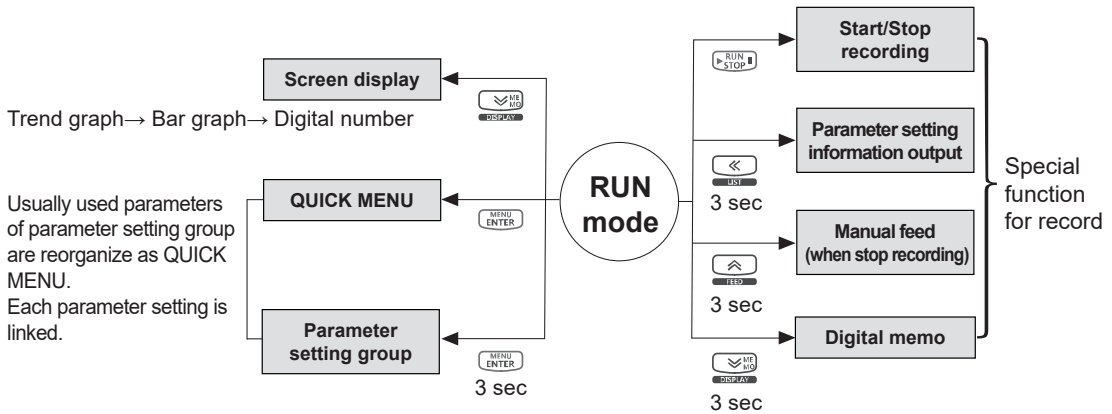

Display Changing

KRN100 displays measuring value as trend graph, bar graph, and digital number display (1-channel, 8-channel, 12-channel).

You can select one by the key.

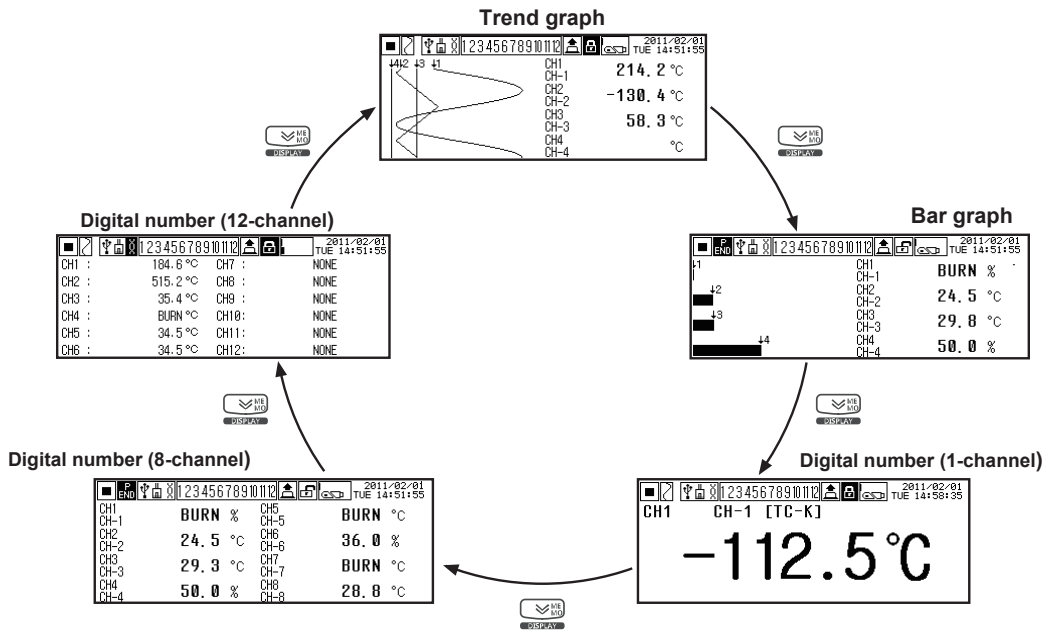

KRN100 Series

QUICK MENU

| QUICK MENU [1] | | | | | |
|----------------|------|-----|------|-----------|------|
| CH | TYPE | DOT | UNIT | PEN COLOR | ▶▶▶ |
| CH_1 | TC-K | 0.0 | 'C | Violet | |
| SET | SET | SET | SET | SET | NEXT |

QUICK MENU consists of usually used parameters for quickly parameter setting.

| Page | Parameter | Description | Linked parameters |
|----------------|-------------|---|--|
| QUICK MENU [1] | CH | Select channel for the QUICK MENU [1] setting | |
| | TYPE | Input type | [INPUT SETUP]-[Input Type] |
| | DOT | Decimal point | [INPUT SETUP]-[Range/Scale Point] |
| | UNIT | Display/Temperature unit | [INPUT SETUP]-[Display/Temp Unit] |
| | PEN COLOR | Pen color | [INPUT SETUP]-[Pen Color] |
| QUICK MENU [2] | CH | Select channel for the QUICK MENU [2] setting | |
| | LOW RANGE | Low-limit input value or graph scale value | [INPUT SETUP]-[Low Range] or [INPUT SETUP]-[Low Graph Scale] |
| | HIGH RANGE | High-limit input value or graph scale value | [INPUT SETUP]-[High Range] or [INPUT SETUP]-[High Graph Scale] |
| | LOW SCALE | Low-limit scale value | [INPUT SETUP]-[Low Scale] |
| | HIGH SCALE | High-limit scale value | [INPUT SETUP]-[High Scale] |
| QUICK MENU [3] | PRINT MODE | Record mode | [RECORD SETUP]-[Record Mode] |
| | PRINT SPEED | Standard record speed | [RECORD SETUP]-[Standard Speed] |
| | PRINT MEMO | Digital memo period | [RECORD SETUP]-[Memo Period] |
| | BACK LIGHT | LCD backlight | [SYSTEM SETUP]-[Backlight] |
| | LCD ON/OFF | LCD backlight ON/OFF | [SYSTEM SETUP]-[Backlight On/Off] |
| QUICK MENU [4] | USB REC | Memory save | [FILE/MEMORY SETUP]-[USB LogData Save] |
| | USB COPY | Call USB COPY window | [FILE/MEMORY SETUP]-[USB Memory Copy/Move] |
| | UPGRADE | Call upgrade window | [USER/INFORMATION SETUP]-[Firmware Upgrade] |
| | CANCEL | Cancel the settings | |
| | SAVE | Save the setting of QUICK MENU [1] to [4] | |

QUICK MENU Setting

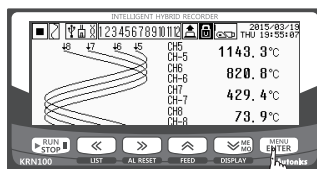

Press the **MENU ENTER** key once in RUN mode and it enters to QUICK MENU. QUICK MENU consists of usually used parameters for quickly parameter setting.

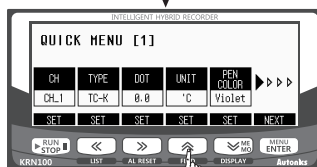

Set the keys following the each parameter. Press the NEXT (**MENU ENTER**) key and it moves to next page.

E.g.)When changing the temperature unit (°C→°F), press the SET (**FEED**) key.

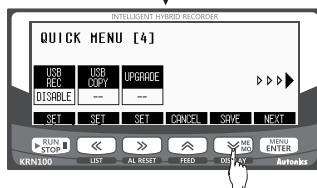

After completing the setting, press the SAVE (**MR MD**) key at QUICK MENU [4] and save the settings. It returns to RUN mode.

Example of QUICK MENU Setting

In case of CH1, recording as input type=TC-U, low-limit input value=300, standard record speed=240mm/h.

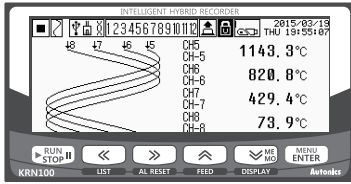

Press the **MENU/ENTER** key in RUN mode to enter QUICK MENU.

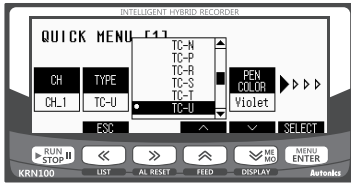

Press the SET (**<<**) key at QUICK MENU[1] and below screen is displayed. Set input type[TYPE] as TC-U by pressing SET (**<<**) (**FEED**) (**ME/MD**) (**DISPLAY**) keys and press the **MENU/ENTER** key.

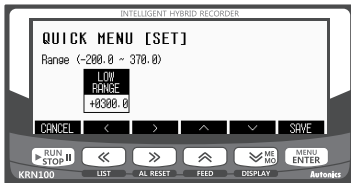

Press the NEXT (**MENU/ENTER**) key once and it moves to QUICK MENU [2]. Press the SET (**<<**) key using (**<<**) (**AL RESET**) (**FEED**) (**DISPLAY**) (**ME/MD**) keys to set low-limit input range[LOW RANGE] as 300. Press the **MENU/ENTER** key.

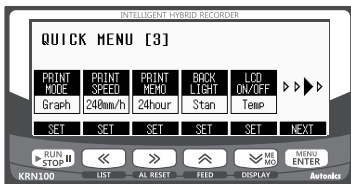

Press the NEXT (**MENU/ENTER**) key once and it moves to QUICK MENU [3]. Press the SET (**<<**) key and set standard record speed [PRINT SPEED] as 240mm/h. Press the **MENU/ENTER** key.

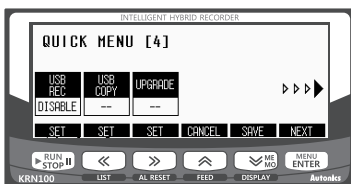

Press the NEXT (**MENU/ENTER**) key once and it moves to QUICK MENU [4]. Press the SAVE (**ME/MD**) (**DISPLAY**) key to save the settings of QUICK MENU [1] to [4] and it returns to RUN mode.

KRN100 Series

Parameters

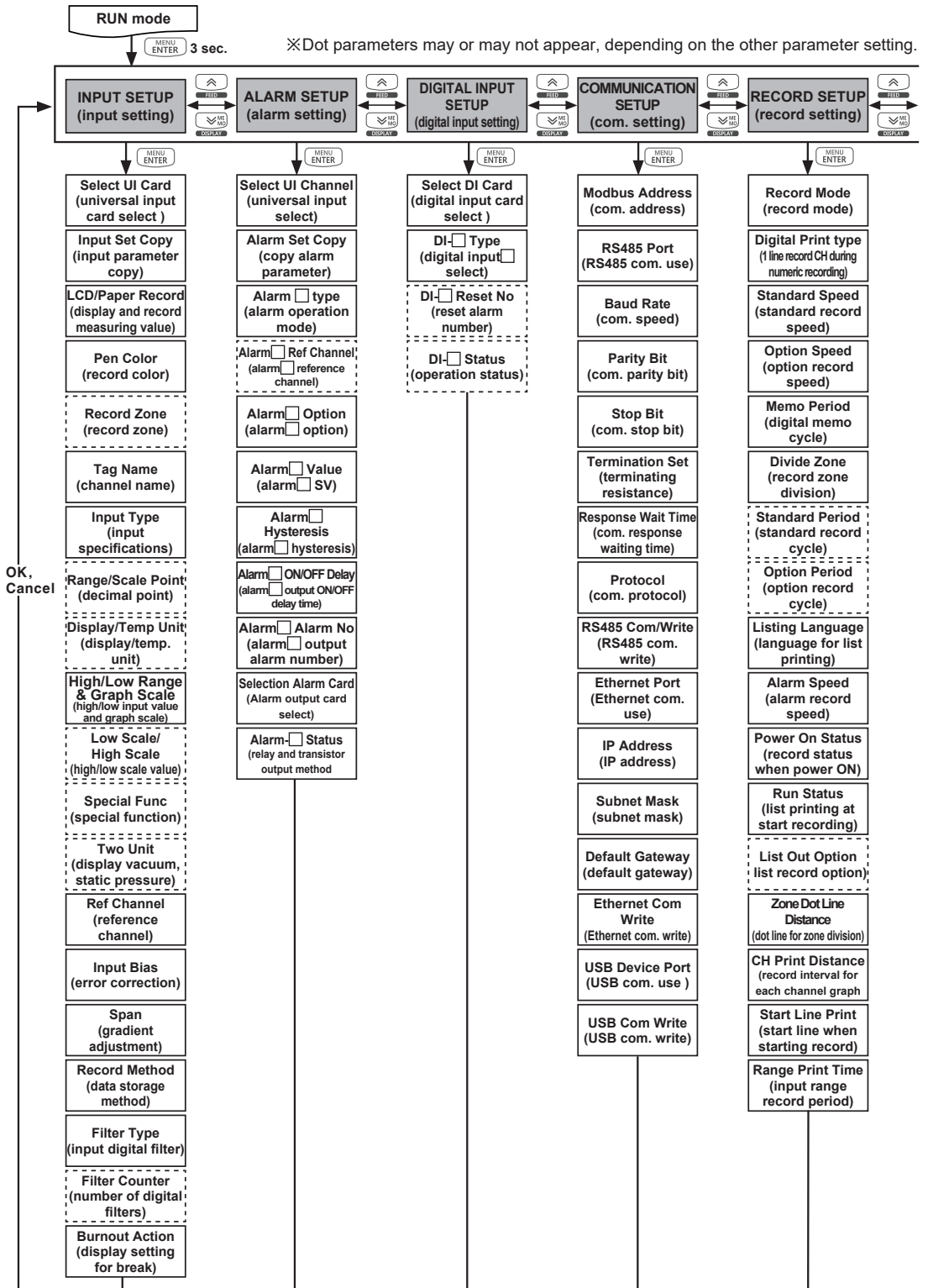

100mm Hybrid Recorder

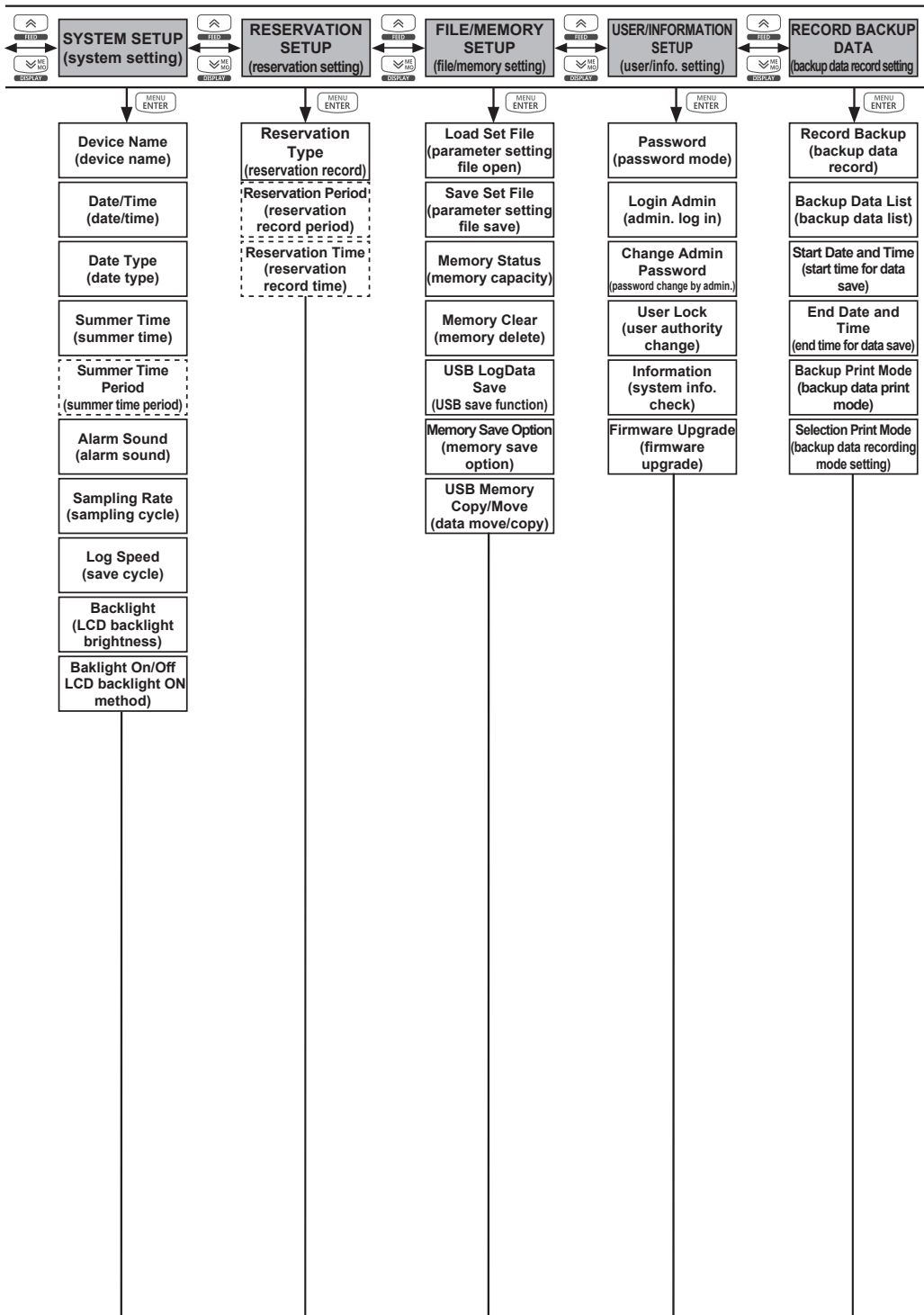

KRN100 Series

■ Factory Default

■ Input setting group [INPUT SETUP]

| Parameter | Default | Parameter | Default | Parameter | Default | Parameter | Default |
|------------------|------------|------------------------------|-------------|----------------------|---------|----------------|---------|
| Select UI Card | Auto set | Input Type | TC-K | Low Scale/High Scale | — | Record Method | Instant |
| Input Set Copy | CH Select | Range/Scale Point | 0 0 | Special Function | None | Filter Type | None |
| LCD/Paper Record | ON | Display/Temp Unit | TC, RTD °C | Two Unit | — | Filter Counter | — |
| Pen Color | Auto set | | Analog % | Reference Channel | — | Burnout Ac ion | OFF |
| Record Zone | None | High/Low Range & Graph Scale | Low -200.0 | Input Bias | 0.0 | | |
| Tag Name | CH-1 to 12 | | High 1350.0 | Span | — | | |

■ Alarm setting group [ALARM SETUP]

| Parameter | Default | Parameter | Default | Parameter | Default | Parameter | Default |
|----------------------------------|-----------|--|---------|--|----------|---|---------|
| Select UI Card | Auto set | Alarm <input type="checkbox"/> Ref Channel | — | Alarm <input type="checkbox"/> Hysteresis * ¹ | 0.0 | Alarm- <input type="checkbox"/> Status * ¹ | NO |
| Alarm Set Copy | CH Select | Alarm <input type="checkbox"/> Option * ¹ | None | Alarm <input type="checkbox"/> ON/OFF Delay * ¹ | 0s | | |
| Alarm1 Type * ¹ | PV.Hi | Alarm1 Value * ¹ | 1350.0 | Alarm <input type="checkbox"/> Alarm No * ¹ | None | | |
| Alarm 2 to 4 Type * ¹ | None | Alarm 2 to 4 Value * ¹ | — | Select Alarm Card | Auto set | | |

■ Digital input setting group [DIGITAL INPUT SETUP]

| Parameter | Default | Parameter | Default | Parameter | Default | Parameter | Default |
|----------------|----------|-----------------------------------|---------|---------------------------------------|---------|-------------------------------------|---------|
| Select DI Card | Auto set | DI- <input type="checkbox"/> Type | None | DI- <input type="checkbox"/> Reset No | — | DI- <input type="checkbox"/> Status | — |

■ Communication setting group [COMMUNICATION SETUP]

| Parameter | Default | Parameter | Default | Parameter | Default | Parameter | Default |
|----------------|---------|--------------------|------------|-----------------|---------|--------------------|---------|
| Modbus Address | 1 | Stop Bit | 2 | RS485 Com Write | Enable | Default Gateway | — |
| RS485 Port | Enable | Termination Set | Disable | Ethernet Port | Disable | Ethernet Com Write | — |
| Baud Rate | 9600 | Response Wait Time | 20ms | IP Address | — | USB Device Port | Enable |
| Parity Bit | None | Protocol | Modbus RTU | Subnet Mask | — | USB Com Write | Enable |

■ Record setting group [RECORD SETUP]

| Parameter | Default | Parameter | Default | Parameter | Default | Parameter | Default |
|--------------------|---------|------------------|---------|------------------------|----------|------------------|---------|
| Record Mode | Graph | Divide Zone | None | Power On Status | Hold | Start Line Print | ON |
| Digital Print type | TwoCH | Standard Period | — | Run Status | OFF | Range Print Time | Disable |
| Standard Speed | 20mm/h | Option Period | — | List Out Option | Standard | | |
| Option Speed | 20mm/h | Lis ing Language | English | Zone Dot Line Distance | 4.0mm | | |
| Memo Period | 2hour | Alarm Speed | 20mm/h | CH Print Distance | 20.0mm | | |

■ System setting group [SYSTEM SETUP]

| Parameter | Default | Parameter | Default | Parameter | Default | Parameter | Default |
|-------------|-----------------|--------------------|---------|---------------|-----------|------------------|---------|
| Device Name | KRN100 Recorder | Summer Time | Disable | Sampling Rate | 125ms | Backlight On/Off | Temp |
| Date/Time | Default set | Summer Time Period | — | Log Speed | None (0s) | | |
| Date Type | yyyy/mm/dd | Alarm Sound | OFF | Backlight | Standard | | |

■ Reservation setting group [RESERVATION SETUP]

| Parameter | Default | Parameter | Default | Parameter | Default | Parameter | Default |
|------------------|---------|--------------------|---------|------------------|---------|-----------|---------|
| Reservation Type | Disable | Reserva ion Period | — | Reserva ion Time | — | | |

■ File/Memory setting group [FILE/MEMORY SETUP]

| Parameter | Default | Parameter | Default | Parameter | Default | Parameter | Default |
|---------------|-----------|---------------|----------|--------------------|---------|----------------------|------------------|
| Load Set File | None | Memory Status | 0% | USB LogData Save | Disable | USB Memory Copy/Move | USB Copy/ Move.. |
| Save Set File | Select... | Memory Clear | Clear... | Memory Save Option | Stop | | |

■ User/Information setting group [USER INFORMATION SETUP]

| Parameter | Default | Parameter | Default | Parameter | Default |
|-------------|---------|-----------------------|---------|------------------|------------|
| Password | Disable | Change Admin Password | — | Information | Display... |
| Login Admin | — | User Lock | OFF | Firmware Upgrade | Auto set |

■ Backup data record setting group [RECORD BACKUP SETUP]

| Parameter | Default | Parameter | Default | Parameter | Default |
|------------------|------------------|---------------------|------------------------|-------------------|---------|
| Record Backup | Stop | Start Date and Time | 0000/00/00 00:00:00 | Backup Print Mode | Graph |
| Backup Data List | File Not Found!! | End Date and Time | 0000/00/00 00:00:00 | Select Print Mode | Graph |

※1. Alarm Type to Alarm No are displayed by the number of connected alarm cards.

※ Shaded parameters are depending on other parameters' SV. Refer to the more information of the parameter.

■ Proper Usage

- Follow instructions in 'Cautions during Use'. Otherwise, it may cause unexpected accidents.
- Install a surge absorber at each end of inductive load coil when controlling high-capacity power relay or inductive load (e.g. magnet).
- Check the polarity of the terminals before wiring the temperature sensor.
For RTD temperature sensor, wire it as 3-wire type, using cables in same thickness and length.
For thermocouple (CT) temperature sensor, use the designated compensation wire for extending wire.
- Keep away from high voltage lines or power lines to prevent inductive noise.
In case installing power line and input signal line closely, use line filter or varistor at power line and shielded wire at input signal line.
Do not use near the equipment which generates strong magnetic force or high frequency noise.
- This unit may be used in the following environments.
 - ① Indoors (in the environment condition rated in 'Specifications')
 - ② Altitude max. 2,000m
 - ③ Pollution degree 2
 - ④ Installation category II