

BEI SENSORS

PRODUCT SELECTION GUIDE



Speed and Position Sensors for Extreme Applications

Built for
Extreme
Environments



BEI SENSORS

As an industrial consumer, you require the highest levels of quality and reliability in the products you purchase.

It is critical that devices operate dependably day after day in some of the most extreme conditions imaginable. BEI Sensors understands these needs and—backed by decades of experience—designs sensors that offer uncompromising quality and performance. BEI Sensors upholds a standard of excellence in our products, customer service experience, and commitment to being your preferred partner for position sensors. We fully understand that your complete satisfaction is key to our success.

BEI Sensors provides reliable position, speed and inclination sensing products for mission-critical and extreme environment applications in the industrial, military/aerospace and off-road equipment markets worldwide. Our products utilize the latest optical, magnetic and potentiometric sensing technologies. The comprehensive product line includes absolute and incremental encoders, Hall effect sensors, as well as rotary and linear potentiometers. Specialized products for harsh environments include those certified for use in hazardous areas, wash-down environments, and applications where they are exposed to extreme vibration, shock and operating temperatures. In addition to an extensive range of standard product offerings, we have the ability and expertise to make product adaptations and create completely customized sensing solutions to suit even the most challenging applications.

BEI Sensors' experienced customer service staff offers an outstanding level of service, both before and after the sale. Our order department quickly answers questions on order status, pricing and availability, or helps specify a unit to meet your exact requirements. Our highly trained applications staff helps with any technical needs—whether it's assistance with an interface or questions about crossing over a competitor's part number. The BEI Sensors engineering team also consults on advanced technical issues. We consistently provide this high level of service to an active customer base of thousands of companies. Everyone at BEI Sensors works toward a common goal—to provide the most reliable products and deliver the best customer service found anywhere.

BEI Sensors is the preferred position sensors partner to leading companies around the globe.

About BEI Sensors	3
Major Industries Served	4
Sensor Technologies	6
Extreme Environments	8
Hazardous Areas	9
Optical Encoders	10
Magnetic Encoders and Hall Effect Sensors	18
Potentiometers	22
Sensor Support Products	24
SwiftComm Interface	26
Product Adaptability	27

Excellence in
Design and
Engineering



Rugged
and
Reliable



Mission
Critical
Applications

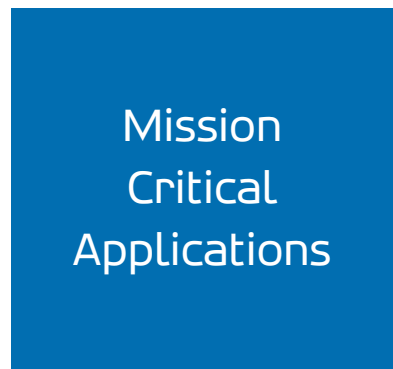

The Utmost
in Service
and Support



Serving the Position Sensing Needs of these Major Industries

These days, engineers have to do more with fewer resources. BEI Sensors helps by acting as an extension of your engineering team. Our application and design engineers assist with everything from creating custom sensors to troubleshooting installations. We are more than just a supplier. We partner with our customers to help make their operations run more easily and efficiently.



Mining

In mining applications, BEI Sensors helps with everything from shaft elevator control and ore cart positioning to the control of heavy equipment such as excavators and earthmovers. Sensors in this environment have to withstand high shock and vibration, along with extremely dusty and wet conditions. BEI manufactures rugged products designed to deliver optimum performance in these demanding operations. In addition, when hazardous area certifications are required, BEI Sensors offers a number of products certified by UL, CENELEC, LCIE and MSHA rating agencies.

Metal Manufacturing

There are few harsher, more corrosive environments than a steel mill. Molten steel is cast into large slabs at blistering temperatures. Water from line sprayers hits freshly poured slabs, creating clouds of steam. Every piece of equipment is exposed to continuous humidity. BEI speed and position sensors are engineered to withstand this unforgiving environment. Encoders are available with stainless steel housings and other protective coatings to prevent corrosion and rust. High IP ratings are offered to resist pressurized spray, condensation, and dust. BEI Sensors' products are built tough to operate reliably in these severe conditions.



Heavy Motors

BEI Sensors has supplied high quality, rugged encoders to heavy motor manufacturers for decades. Heavy motors are found in all types of harsh industrial environments, and require extremely rugged feedback devices. BEI's products have the proven reliability needed for successful operation in these environments. If a motor is needed for use in a hazardous area, simply select one of BEI's large catalog of UL and ATEX pre-certified products. They provide a drop-in feedback solutions that are ready to operate in hazardous areas worldwide. Custom product adaptations are also available for seamless integration into any motor design. BEI's design engineers are always on hand to provide any amount of customization, from simple shaft and connector modifications to designing a new sensor around your exact requirements.



Oil and Gas

Sensors used in the oil and gas industry must withstand high temperature and pressure, potentially explosive locations, and extreme shock and vibration, along with exposure to chemicals, dirt and moisture. Position sensors perform crucial functions in oil and gas applications and must operate reliably day in and day out to ensure an optimized yield. BEI Sensors is well aware of these unique upstream, midstream, and downstream requirements and has designed products that feature uncompromising quality and performance. Hard anodized housings, gross leak tests, extended temperature ranges and a variety of sealing options are available on numerous BEI products. BEI Sensors also offers one of the largest selection of hazardous area rated products, including UL Class I Division 1 and 2, and Class II Division 1 and 2, and ATEX Zone 1 and Zone 2 (See page 9). A variety of communication protocols including Profibus, CANopen and DeviceNet are also offered.

Off-Road Equipment for Construction and Agriculture

BEI Sensors' products have stood the test of time, providing a high degree of reliability and performance, while withstanding the severe conditions posed by off-road and industrial vehicle applications. These demanding applications rely on precise position sensing and redundant safety for steering and wheel systems, steer-by-wire systems, gear sensing, pedal and throttle control, hand acceleration, valve and control logging, cabin controls and more. Whether exposed to dirt, extreme temperatures, or moisture, the rugged construction of BEI Sensors products ensures their accurate and reliable operation day after day, year after year.



Cranes

Cranes are critical pieces of equipment for a variety of industries around the world. The environments where they operate are almost as diverse as the materials they move. Whether it's loading and unloading cargo in unforgiving seaports, or handling material on a factory floor, cranes require reliable feedback solutions to do their job properly and safely. BEI Sensors offers a variety of position sensors and a real-time wireless interface system rugged enough for the toughest environmental conditions, while providing the position and speed feedback needed to move materials with precision and accuracy.

Choosing the Right Sensor Technology

BEI offers a variety of speed and position sensing technologies. It's important to choose one that's suited to your particular application. The sensor's operating environment, required degree of precision, output type, speed, and physical configuration all must be considered. The descriptions of the different technologies on these pages will help guide you in choosing the optimal speed and position sensing technology.

Optical Technology

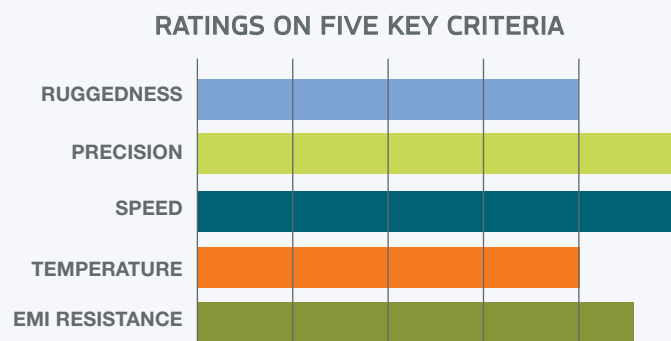

Optical sensing technology uses the interruption of light to detect movement. Optical encoders have an internal code disc with opaque lines or patterns that are rotated in the path of a light source, typically from an LED. The code disc acts like a shutter to alternately block (OFF) or unblock (ON) the light to an internal photodetector. The photodetector senses the alternating light beam, which the encoder's electronics convert into an

electrical signal. This signal is passed to an external control system through the encoder's output. Optical sensing technology is the most precise and offers the highest resolution of the position sensing technologies. It is also resistant to environmental magnetic interference and, when enclosed in a metal housing, highly resistant to EMI. BEI Sensors' optical encoders are well sealed, allowing them to operate in harsh and dirty environments. They are also highly resistant to shock and vibration, and are capable of withstanding a 50 g, 11 msec shock pulse and 20 g's of vibration (5 to 2000 Hz). This level of robustness makes BEI encoders well-suited for most industrial applications.

BEI optical encoders are ideal for numerous types of industrial processes, such as oil well drilling, machine control, agricultural machinery, web process control, robotics, elevators, construction equipment, cranes, motor feedback and any closed loop control systems.

Magnetic / Hall Effect Technology

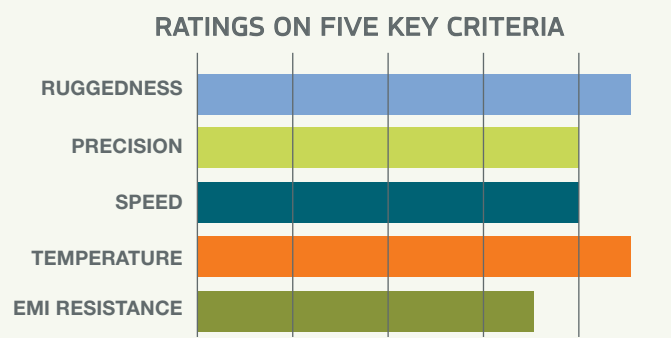

Magnetic sensing technology uses changes in magnetic fields to detect movement. There are two ways magnetic technology is integrated into the BEI Sensors offerings, digital encoders and

analog Hall effect position sensors. Magnetic encoders use a disc that has been magnetized with multiple, north/south pole pairs that are in the form of radial lines or patterns. In place of a photodetector, magnetic encoders use an ASIC designed to detect alternating north and south poles as the disc is rotated past it. As the ASIC senses the change in magnetic poles, internal electronics convert it into a digital electrical signal that is then passed through the device's output.

In the Hall effect sensor configuration, the internal disc is magnetized with a single pole pair. The disc is attached to the sensor's rotor which is then coupled to the motion being measured. The sensor's ASIC is designed to detect the change in the direction of the magnetic field as the disc rotates above

it. These changes in magnetic field are converted to an analog signal that is ratiometric (proportional) to the angle of the rotating disc.

Hall effect sensors are typically used to resolve angular position with an analog output while magnetic encoders are most often used to detect rotational speed and direction with a digital output. Magnetic encoders tend to have lower resolution and precision than their optical counterparts and are more susceptible to environmental magnetic interference. However

both products are ideal for operation in very high temperatures and environments with extreme shock.

Ideal applications for magnetic encoders include wind energy, tree harvesting, traction motors for rail equipment and pavement profiling. Hall effect sensors excel in steering, pedal and throttle for off-road equipment, dancer controls in web processing, flow control valves and elevator door opener applications.

Potentiometric Technology

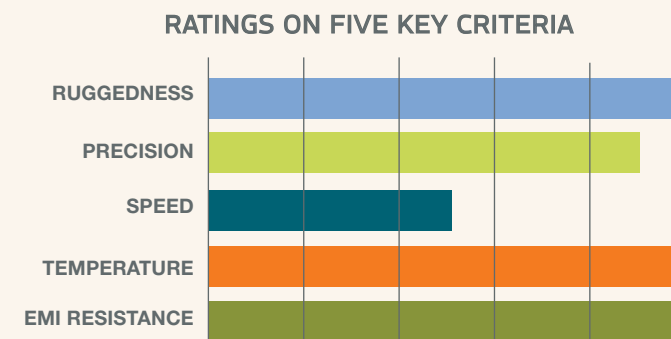

Potentiometric sensing technology is available in one of three configurations: wirewound, conductive plastic and hybrid.

Wirewound potentiometers are comprised of a resistive element (coil) and a contact spring (wiper). The coil is made from a very fine wire that is precisely wound onto a mandrel. The wiper, a specially engineered precious metal contact, wipes across the wound coil. The coil is fixed internally to the sensor's housing and the wiper is attached to the sensor's rotor which in turn is coupled to the motion being measured. A voltage is applied across the coil and the coil becomes a voltage divider. As the motion being measured rotates the wiper across the energized coil, a voltage proportional to the rotational position can be read between the coil and the wiper. The output changes in discrete steps as the wiper moves across the individual coil windings.

Conductive plastic potentiometers are very similar to wirewound, except that the wiper moves across a conductive plastic element rather than a coil. The conductive plastic element is comprised of a substrate and a resistive epoxy. In its pre-cured state this resistive epoxy material is referred to as "ink". The ink is applied to a substrate using a silk screening process. Once

cured, the ink acts very similarly to the coil in a wirewound potentiometer, with the advantage of having a very uniform, smooth surface. This surface provides a more continuous output and longer life as compared to a wirewound potentiometer.

As its name implies, hybrid potentiometers use a combination of the two previous mentioned configurations, using a wirewound coil coated with the conductive plastic material.

Wirewound potentiometers provide the highest accuracy of the three configurations and dissipate power very well; however because of the metal-to-metal contact between the wiper and coil, wirewounds have a shorter operating life. Conductive plastic potentiometers provide the highest resolution or output smoothness and have a higher operational life than wirewounds, however it is more difficult to get the high linearity (accuracy) available from a standard wirewound potentiometer. Hybrid potentiometers are able to combine the best aspects of both other configurations. A hybrid potentiometer has a better ability to dissipate power (over conductive plastic pots) and has improved resolution or output smoothness (similar to conductive plastic potentiometers). The use of conductive plastic material gives hybrids a longer operating life over wirewounds.

Potentiometers in general have several benefits including small package size and weight, resistant to electromagnetic interference (EMI), temperature stability and are able to work at very high (300C max) and low (-55°C) operating temperatures. Ideal applications include aircraft control surfaces, in-cylinder hydraulics and oil field downhole measuring.

Sensors for Extreme Environments

BEI understands the challenges posed by extreme environments and has developed an extensive line of products designed to operate in the harshest conditions imaginable. The icons below each represent a particular environmental extreme. They are used in the product selection pages of this guide (pages 8–25) as a quick visual indicator of which products are designed to operate in which extreme environment condition.

Wet If a sensor has to operate in a liquid environment, it must have adequate sealing and the appropriate IP rating (as a measure of ingress protection) to guard against contamination. Products rated IPX5 are protected from “water jet” liquid ingress. An IPX6 rating indicates protection from “powerful water jets.” An IPX7 rating means the product can be immersed in water up to 1 meter for 30 second durations. BEI products with this icon are rated IPX6 or above.

Dirty/Dusty BEI products with this icon are rated IP6X and are considered “dust tight,” meaning that they will operate in the constant presence of dust. The majority of BEI products are rated to this level and this icon represents this rating. Products with the lower IP5X rating are considered as only “dust protected,” which means that dust ingress is still possible. IP5X rated products are recommended for environments where dust is only occasionally present.

Extended Temperatures The majority of BEI Sensors products are rated to operate over a wide temperature range—typically 0 to +70°C. If your application requires operation in extreme temperatures (above or below these ranges), BEI offers extended temperature options. Products with this icon have extended temperature ratings (beyond their stated operating temperature) as a standard option.

High Shaft Load For applications with shaft loading conditions it is best to use encoders over Hall effect sensors or potentiometers. Encoders have internal bearing structures that can carry some load. In applications that use gears or drive belts, excessive radial (side) loading of the shaft can shorten bearing life. Encoders should be specified in accordance with the anticipated radial loading. Typical maximum loads for industrial encoders are 5 to 40 lbs (22 to 178 N). Ultra heavy-duty encoders are available to withstand heavier loads. Encoders with this icon can withstand high shaft loads in the range of 40 to 300 lbs (178 to 1335 N). See individual product data sheets to determine actual maximum load.

Corrosive or Washdown A hard anodized finish is recommended for sensors intended to operate in a corrosive environment. In food or medical-grade applications, where washdown may occur, an electroless nickel coating or stainless steel housing is recommended. Products with this icon incorporate special finishes or housing material as a standard option.

Hazardous Areas Hazardous locations require equipment designed and certified to operate safely in potentially explosive environments. Products with this icon have certification for one of the following: explosion-proof, flame proof, intrinsically safe, or non-incendive. Refer to the next page for complete information on hazardous area certifications.

Shock and Vibration The use of position sensors in high shock or vibration environments that are not properly rated can result in output errors, reduced accuracy, or component failure. It is important to be aware of an application’s expected shock and vibration and select a sensor rated for that environment. Products with this icon can withstand greater than 100 g’s of shock or over 10 g’s of vibration. See individual product data sheets for maximum shock and vibration ratings.

Hazardous Area Products

BEI Sensors offers a complete selection of UL and ATEX certified position sensing products. Certifications include UL Class I Division 1 and 2, and Class II Division 1 and 2, as well as ATEX Zone 1 and Zone 2. The tables on this page provide details on BEI Sensors products’ certifications. A variety of protection methods are available. The four most common are described below.

Explosion Proof Construction

- Enclosure can withstand internal ignition and contain the explosion without damage to the enclosure
- Heated gases from an explosion that pass through gaps or joints in the assembly will be cooled sufficiently to not ignite gases outside the housing
- Must be connected using gas-tight conduit
- Rated for Division 1 or Zone 1 installations

Flame Proof Construction

- Enclosure can withstand internal ignition of volatile gas-to-air mixtures without damage to the enclosure
- Allows for termination using a certified cable gland and cable
- Cannot be used for Division 1 hazardous areas

Intrinsic Safety

- Limits the maximum energy that can be delivered into the hazardous location
- Has limitations on the amount of energy that can be stored within the body of the device
- Ensures that even in double fault condition, not enough energy is supplied to or stored in the encoder which could create a spark or heated surface to ignite gas, vapor, dust or fiber in the hazardous area
- Must be used with Intrinsically Safe (IS) barrier. An IS encoder installed without an IS barrier is not an IS system.

Nonincendive

- Assures no sparking or hot surfaces will occur in the device under normal operating conditions (unlike intrinsically safe encoders which are evaluated under fault conditions)
- Acceptable in Division 2 and Zone 2 installations where explosive agents are present only in abnormal operating conditions

Hazardous Environment Groups		
Gas Groups		Dust Groups
Class I		Class II
Division 1 & 2	Zone 0, 1 & 2	Division 1 & 2
A (acetylene)	IIC (acetylene & hydrogen)	E (metals) (Div 1 only)
B (hydrogen)		F (coal)
C (ethylene)	IIB (ethylene)	G (grain)
D (propane)	IIA (propane)	

European “Flame Proof” Approvals	
Encoder Type	CENELEC/ATEX Category 2, Zone 1 and 21
GAMX, GEMX, CAMX, CEMX	Ex d IIC T6
GAUX, GEUX, CAUX, CEUX, PAUX, PEUX	Ex d IIC T6

North American and European “Nonincendive” Approvals		
Encoder Type	Division 2, Groups: A, B, C, D, F & G	CENELEC/ATEX Zone 2
H20, H25, HS25, ES20, ES25, HS35, HS45		
PHU9		Ex nA II T4

North American “Explosion Proof” & European “Flame Proof” Approvals			
Encoder Type	CENELEC/ATEX	U.S., Canadian Standards Class I, Div 1, Group:	U.S., Canadian Standards Class II, Div 1, Group:
H38 (Standard)		D	
H38 (w/ Labyrinth Seal)	II 2 G Ex d IIB T4	C, D	E, F, G
H40		D	
HS52	II 2 G Ex d IIB T4 Gb	C, D (US only)	
SwiftComm	Ex d IIC	B, C, D	E, F, G

Encoders with metal connector or conduit terminations are rated to EN 55011 and EN 61000-6-2. For plastic connector, pigtail or shielded/jacketed cable terminations, consult factory

North American and European “Intrinsic Safety” Approvals				
Encoder Type	CENELEC/ATEX	U.S., Canadian Standards Class I, Div 1, Group:	U.S., Canadian Standards Class II, Div 1, Group:	Canadian Standards Class I, Zone 0, Group:
H20, H25, ES20, ES25, H38, H40, HS20, HS25, HS35, HS45	Ex ia IIC T4	A, B, C, D	E, F, G	IIC
IBM5, IHM5, IH05, IB05, IHK5, IBK5, IHM9	Ex ia IIC T4			

Optical Encoders

Rotary Incremental Optical Encoders

Model	Body	Shafted	Through Shaft	Blind Shaft	Shaft/Bore Size	Terminations	Output Options (See Below)	Resolution (Max)	Mechanical Speed RPM (Max)	Standard Operating Temp °C	AVAILABLE OPTIONS FOR USE IN EXTREME ENVIRONMENTS - SEE PAGE 8						
											Wet	Dirty/Dusty	Extended Temp	High Shaft Load	Corrosive/Washdown	Hazard Area (See Pg 9)	High Shock/Vibration
H20	2.0"				0.25 to 0.375"	Connector, Cable	D	4,096	8,000	0 to +70							
HS20	2.0"				0.25 to 0.625"	Connector, Cable	D	1,024	6,000	0 to +70							
ES20	2.0"				0.25 to 0.375"	Connector, Cable	D	1,024	5,000	0 to +70							
DXM5	2.28" (58mm)				0.39" (10mm)	Cable	D, S/C	80,000	9,000	-30 to +100							
DH05	2.28" (58mm)				0.24 to 0.59" (6 to 15mm)	Connector, Cable	D, S/C	80,000	6,000	-30 to +100							
	IH05/IB05	2.28" (58mm)			0.24 to 0.59" (6 to 15mm)	Connector, Cable	D	80,000	6,000	-30 to +70							
	IHK5/IBK5	2.28" (58mm)			0.24 to 0.59" (6 to 15mm)	Connector, Cable	D	80,000	6,000	-30 to +70							
GHT514	2.28" (58mm)				0.24 to 0.55" (6 to 14mm)	Connector, Cable	D	2,500	6,000	-20 to +80							
H25	2.5"				0.375 to 0.5"	Connector, Cable	D, S/C	72,000	30,000	0 to +70							
HS25	2.5"				0.375 to 0.75"	Connector, Cable	D	2,048	6,000	0 to +70							

OUTPUT OPTIONS:	A Analog (ex: 4-20 mA, 0-10V, etc) BCD Binary Coded Decimal	CAN CANopen D Digital	DN DeviceNet GC Gray Code	NB Natural Binary Profi Profibus	PWM Pulse width Modulation S/C Sin/Cos	SSI Serial Synchronous Interface	TB Terminal Box X Excess Gray Code
------------------------	--	--	--	---	---	---	---

Optical Encoders















































Rotary Incremental Optical Encoders

Model	Body	Shafted	Through Shaft	Blind Shaft	Shaft/Bore Size	Terminations	Output Options (See Below)	Resolution (Max)	Mechanical Speed RPM (Max)	Standard Operating Temp °C	AVAILABLE OPTIONS FOR USE IN EXTREME ENVIRONMENTS - SEE PAGE 8						
											Wet	Dirty/Dusty	Extended Temp	High Shaft Load	Corrosive/Washdown	Hazard Area (See Pg 9)	High Shock/Vibration
ES25	2.5"				0.25 to 0.375"	Connector	D	2,048	5,000	0 to +70							
HS35	3.5"				0.50 to 1.00"	Connector, Cable	D, S/C	80,000	6,000	0 to +70							
HS35 Drawworks	3.5"				1.00"	Connector, Cable	D	5,000	6,000	-40 to +85							
GHM9/GXM9	3.54" (90mm)				0.43 to 0.55" (11 to 14mm)	Connector, Cable, TB	D	10,000	6,000	20 to +80							
	NHM9/NXM9	3.54" (90mm)			0.43 to 0.55" (11 to 14mm)	Connector, Cable, TB	A	10,000	6,000	20 to +80							
	IHM9	3.54" (90mm)			0.43 to 0.55" (11 to 14mm)	Connector, Cable, TB	D	80,000	6,000	-30 to +70							
H38	3.8"				.375"	Conduit	D	72,000	10,000	0 to +70							
H40	4.0"				0.625"	Conduit	D	72,000	10,000	0 to +70							
GAUX/GEUX	4.29" (109mm)				0.63 to 1.18" (16 to 30mm)	Cable	D	10,000	3,000	-20 to +60							
HS45	4.5"				1.75"	Connector	D	8,192	5,000	0 to +70							
GAMX/GEMX	4.57" (116mm)				0.47" (12mm)	Cable	D	10,000	6,000	-20 to +60							
HS52	5.2"				0.39" Spline (10mm)	Conduit	D	80,000	6,000	0 to +70							

OUTPUT OPTIONS:	A Analog (ex: 4-20 mA, 0-10V, etc) BCD Binary Coded Decimal	CAN CANopen D Digital	DN DeviceNet GC Gray Code	NB Natural Binary Profi Profibus	PWM Pulse width Modulation S/C Sin/Cos	SSI Serial Synchronous Interface	TB Terminal Box X Excess Gray Code
------------------------	--	--	--	---	---	---	---

Optical Encoders

Rotary Single-Turn Absolute Encoders













Model	Body	Shafted	Through Shaft	Blind Shaft	Shaft/Bore Size	Terminations	Output Options (See Below)	Resolution (Max)	Mechanical Speed RPM (Max)	Standard Operating Temp °C	AVAILABLE OPTIONS FOR USE IN EXTREME ENVIRONMENTS - SEE PAGE 8						
											Wet	Dirty/Dusty	Extended Temp	High Shaft Load	Corrosive/Washdown	Hazard Area (See Pg 9)	High Shock/Vibration
 CHM5	2.28" (58mm)				0.24 to 0.39" (6 to 10mm)	Connector, Cable	NB, GC, SSI, Profi, CAN, Biss, RS232, PWM	16 bits	9,000	-20 to +90							
 CHO5	2.28" (58mm)				0.24 to 0.55" (6 to 14mm)	Connector, Cable	NB, GC, SSI, Profi, Biss, CAN, SSI	16 bits	6,000	-20 to +85							
 H25/H25X	2.5"				0.375" to 0.50"	Connector, Cable	NB, GC, BCD, X, A	15 bits	12,000	0 to +70							
 HS35	3.5"				0.50 to 1.00"	Connector, Cable	NB, GC, SSI, A	16 bits*	6,000	0 to +70							
 CHM9	3.54" (90mm)				0.43 to 0.47" (11 to 12mm)	Connector, Cable	NB, GC, SSI, Profi, Biss, RS232, A	16 bits*	6,000	-20 to +90							
 H38	3.8"				0.375"	Conduit	NB, GC, SSI, RS422, A	13 bits	10,000	0 to +70							
 H40	4.0"				0.625"	Conduit	NB, GC, SSI, BCD, X, A	13 bits	10,000	0 to +70							

* 16-bit version available Q3 2012



































OUTPUT OPTIONS:	A Analog (ex: 4-20 mA, 0-10V, etc) BCD Binary Coded Decimal	CAN CANopen D Digital	DN DeviceNet GC Gray Code	NB Natural Binary Profi Profibus	PWM Pulse width Modulation S/C Sin/Cos	SSI Serial Synchronous Interface	TB Terminal Box X Excess Gray Code
------------------------	--	--	--	---	---	---	---

Optical Encoders

Rotary Single-Turn Absolute Encoders (continued)

Model	Body	Shafted	Through Shaft	Blind Shaft	Shaft/Bore Size	Terminations	Output Options (See Below)	Resolution (Max)	Mechanical Speed RPM (Max)	Standard Operating Temp °C	AVAILABLE OPTIONS FOR USE IN EXTREME ENVIRONMENTS - SEE PAGE 8						
											Wet	Dirty/Dusty	Extended Temp	High Shaft Load	Corrosive/Washdown	Hazard Area (See Pg 9)	High Shock/Vibration
 CAUX/CEUX	4.29" (109mm)				0.63 to 1.18" (16 to 30mm)	Cable	CAN, SSI	14 bits	3,000	-20 to +40							
 CAMX/CEMX	4.57" (116mm)				0.47" (12mm)	Cable	NB, GC	13 bits	6,000	-20 to +40							

Rotary Multi-Turn Absolute Encoders

Model	Body	Shafted	Through Shaft	Blind Shaft	Shaft/Bore Size	Terminations	Output Options (See Below)	Resolution (Max)	Mechanical Speed RPM (Max)	Standard Operating Temp °C	AVAILABLE OPTIONS FOR USE IN EXTREME ENVIRONMENTS - SEE PAGE 8						
											Wet	Dirty/Dusty	Extended Temp	High Shaft Load	Corrosive/Washdown	Hazard Area (See Pg 9)	High Shock/Vibration
 MHK5	2.28" (58mm)				0.59" (15mm)	Connector, Cable	SSI, RS232, DN, CAN, Profi	13x16 bits	6,000	-40 to +85							
 PHM5/MHM5	2.28" (58mm)				0.24 to 0.39" (6 to 10mm)	Connector, Cable	SSI, RS232, DN, CAN, Profi	13x16 bits	6,000	-20 to +85							
 PHO5	2.28" (58mm)				0.24 to 0.59" (6 to 15mm)	Connector, Cable	CAN, SSI, Profi, RS232	13x16 bits	6,000	-20 to +85							
 HMT25	2.5"				0.375" to 0.5"	Connector	NB, GC, SSI, A	12x12	6,000	0 to +70							
 PHM9	3.54" (90mm)				0.43 to 0.47" (11 to 12 mm)	Connector, Cable, Terminal Box	NB, GC, SSI, RS232, CAN, Profi	13x16 bits	6,000	-20 to +85							
 PHU9	3.54" (90mm)				1.18" (30mm)	Connector, Cable, Terminal Box	SSI, RS232, CAN, Profi	13x16 bits	3,600	-20 to +80							
 PAUX	4.29" (109mm)				0.63 to 1.18" (16 to 30mm)	Cable	CAN, SSI	13x16 bits	3,000	-20 to +40							

OUTPUT OPTIONS:

A Analog (ex: 4-20 mA, 0-10V, etc)
BCD Binary Coded Decimal

CAN CANopen
D Digital

DN DeviceNet
GC Gray Code

NB Natural Binary
Profi Profibus

















PWM Pulse width Modulation
S/C Sin/Cos

SSI Serial Synchronous Interface

















TB Terminal Box
X Excess Gray Code

Magnetic Encoders and Hall Effect Sensors

Rotary Incremental Encoders

Model	Body	Shafted	Through Shaft	Blind Shaft	Shaft/Bore Size	Terminations	Output Options (See Below)	Resolution (Max)	Mechanical Speed RPM (Max)	Standard Operating Temp °C	AVAILABLE OPTIONS FOR USE IN EXTREME ENVIRONMENTS - SEE PAGE 8						
											Wet	Dirty/Dusty	Extended Temp	High Shaft Load	Corrosive/Washdown	Hazard Area (See Pg 9)	High Shock/Vibration
 HHM3	1.18" (30mm)				0.16 to 0.24" (4 to 6mm)	Connector, Cable	D	1,024	6,000	-40 to +100 (at 5Vdc)							
 HHK5	2.28" (58mm)				0.24 to 0.39" (6 to 10mm)	Connector, Cable	D	1,024	6,000	-40 to +100 (at 5Vdc)							
 HHM5	2.28" (58mm)				0.24 to 0.39" (6 to 10mm)	Connector, Cable	D	1,024	6,000	-40 to +100 (at 5Vdc)							

Rotary Single-Turn Absolute Encoders

Model	Body	Shafted	Through Shaft	Blind Shaft	Shaft/Bore Size	Terminations	Output Options (See Below)	Resolution (Max)	Mechanical Speed RPM (Max)	Standard Operating Temp °C	AVAILABLE OPTIONS FOR USE IN EXTREME ENVIRONMENTS - SEE PAGE 8						
											Wet	Dirty/Dusty	Extended Temp	High Shaft Load	Corrosive/Washdown	Hazard Area (See Pg 9)	High Shock/Vibration
 AHK3	1.18" (30mm)				0.16" (4mm)	Connector, Cable	A, CAN, SSI	12 Bits	6,000	-40 to +85							
 AHM3	1.18" (30mm)				0.16 to 0.24" (4 to 6mm)	Connector, Cable	SSI, CAN, A, PWM	12 Bits	6,000	-40 to +85							
 AHM5/AXM5	2.28" (58mm)				0.24 to 0.39" (6 to 10mm)	Connector, Cable	SSI, A, PWM	12 Bits	6,000	-40 to +85							

OUTPUT OPTIONS:

A Analog (ex: 4-20 mA, 0-10V, etc)
BCD Binary Coded Decimal

CAN CANopen
D Digital

DN DeviceNet
GC Gray Code

NB Natural Binary
Profi Profibus

PWM Pulse width Modulation
S/C Sin/Cos

SSI Serial Synchronous Interface

TB Terminal Box
X Excess Gray Code

Magnetic Encoders and Hall Effect Sensors

Rotary Multi-Turn Absolute Encoders

Model	Body	Shafted	Through Shaft	Blind Shaft	Shaft/Bore Size	Terminations	Output Options (See Below)	Resolution (Max)	Mechanical Speed RPM (Max)	Standard Operating Temp °C	AVAILABLE OPTIONS FOR USE IN EXTREME ENVIRONMENTS - SEE PAGE 8						
											Wet	Dirty/Dusty	Extended Temp	High Shaft Load	Corrosive/Washdown	Hazard Area (See Pg 9)	High Shock/Vibration
THM4/THX4	1.42" (36mm)				0.24 to 0.39" (6 to 10mm)	Connector, Cable	SSI, CAN, A	12x13 Bits	12,000	-40 to +85							
THK4	1.42" (36mm)				0.24" (6mm)	Connector	SSI, CAN, A	12x13 Bits	12,000	-40 to +85							
THM5/TXM5	2.28" (58mm)				0.24 to 0.39" (6 to 10mm)	Connector, Cable	SSI, CAN, PWM, A	12x16 Bits	6,000	-40 to +85							
THK5	2.28" (58mm)				0.24 to 0.59" (6 to 15mm)	Connector, Cable	SSI, CAN, PWM, A	12x16 Bits	6,000	-20 to +85							









Hall Effect Sensors

Model	Body	Shafted	Through Shaft	Blind Shaft	Shaft/Bore Size	Terminations	Output Options (See Below)	Resolution	Linearity	Range of Motion	Standard Operating Temp °C	Spring Return	AVAILABLE OPTIONS FOR USE IN EXTREME ENVIRONMENTS - SEE PAGE 8					
													Wet	Dirty/Dusty	Extended Temp	High Shaft Load	Corrosive/Washdown	Hazard Area (See Pg 9)
8360	82mm				20.3mm (spline)	Connector	PWM, CAN, Programmable	12 Bit	0.6%	15° to 360°	-30 to +85							
9960	37mm				9.5mm (blade)	Connector, Cable	PWM, CAN, Programmable	12 Bit	0.6%	15° to 360°	-40 to +125	CW, CCW						
9360	41mm				4.6mm	Connector	PWM, CAN, Programmable	12 Bit	0.6%	15° to 360°	-40 to +85	CW, CCW						
HCW4	50mm	Shaft system w/magnet sold separately, ref M9105 Series				Cable	Incremental	1024	n/a	0° to 360° continuous rotation	-40 to +85	n/a						
	50mm	Shaft system w/magnet sold separately, ref M9105 Series				Cable	A, PWM, CAN, SSI	12 Bit	±0.3%	15° to 360° PWM and analog 0° to 360° CANopen, SSI	-40 to +85	n/a						
TCW4	52mm	Shaft system w/magnet sold separately, ref M9105 Series				Cable	A, PWM, CAN, SSI	12 x13 Bit	±0.3% single turn	8,192-turn, continuous rotation	-20 to +85	n/a						











OUTPUT OPTIONS:	A Analog (ex: 4-20 mA, 0-10V, etc)	BCD Binary Coded Decimal	CAN CANopen	D Digital	DN DeviceNet	GC Gray Code	NB Natural Binary	Profi Profibus	PWM Pulse with Modulation	S/C Sin/Cos	SSI Serial Synchronous Interface	TB Terminal Box	X Excess Gray Code
------------------------	---	---------------------------------	--------------------	------------------	---------------------	---------------------	--------------------------	-----------------------	----------------------------------	--------------------	---	------------------------	---------------------------

Potentiometers

Rotary Potentiometers

Series	Range of Motion	Package Size	Number of Outputs/Type	Life	Drive Interface	Supply Voltage	Standard Operating Temperature °C	Linearity	Spring Return	Termination	AVAILABLE OPTIONS FOR USE IN EXTREME ENVIRONMENTS - SEE PAGE 8						
											Wet	Dirty/Dusty	Extended Temp	High Shaft Load	Corrosive/Washdown	Hazard Area (See Pg 9)	High Shock/Vibration
 1200-2800	320° to 358°	22.225 to 76.20mm	1 to 8	2x10 ⁶ to 50x10 ⁶	Solid Shaft, Flatted	0.5W to 7W not to exceed 400V	-55 to +125	0.15 to 0.5		Solder Terminals							
 9850/9860	85°, 130°	53 x 25mm	1 or 2/Analog ratiometric	1 x 10 ⁶	Blind Shaftkey	0.15 W	-40 to +125	2%	CW, CCW	Metri Pack 150.2, 3-pin, 6-pin							
 5320	240°	18x16x12mm	1/Analog ratiometric	1 x 10 ⁶	Solid Shaft, Flatted	0.25 W	-40 to +125	2%		Terminal Board							

Linear Potentiometers

Series	Range of Motion	Package Size	Number of Outputs/Type	Life	Drive Interface	Supply Voltage	Standard Operating Temperature °C	Linearity	Spring Return	Termination	AVAILABLE OPTIONS FOR USE IN EXTREME ENVIRONMENTS - SEE PAGE 8						
											Wet	Dirty/Dusty	Extended Temp	High Shaft Load	Corrosive/Washdown	Hazard Area (See Pg 9)	High Shock/Vibration
 700	1 to 12" (25.4 to 304.8mm)	0.375L 0.5"Ø (9.52L 12.7mm Ø)	1/Analog ratiometric	5 x 10 ⁵	Shaft, Threaded	0.25 W/in	-40 to +300	2%		Flying Lead, 3-Wire							
 600	1 to 12" (25.4 to 304.8mm)	1 to 12 x 0.62" (25.4x304.8x 15.75mm)	1/Analog ratiometric	10 x 10 ⁶	Shaft, Threaded	0.25 W	-55 to +125	0.7% to 0.08%		Flying Lead, 3-Wire							
	6300	50 to 100mm	77 to 1077mm x 22mm	1 x 10 ⁶	In Cylinder	0.5W per 50mm	-40 to +125	0.75% to 0.038%		Flying Lead, 3-Wire, Pressure header							
	6400	2 to 20" (50.8 to 508mm)	3.3 to 21 x 0.48" (83.82 x 533,4 x 12.19mm)	1 x 10 ⁶	In Cylinder	0.5W per 2"	-40 to +125	0.75% to 0.038%		Flying Lead, 3-Wire, Pressure header							
 9600	12.7 to 38.1mm	27 to 52mm x 13mm x 9mm	1/Analog ratiometric	1 x 10 ⁶	Shaft	0.25 W to 0.75W	-40 to +135	1% to 0.25%	Compression	Solder lugs, 3							

OUTPUT OPTIONS:

A Analog (ex: 4-20 mA, 0-10V, etc)
BCD Binary Coded Decimal

CAN CANopen
D Digital

DN DeviceNet
GC Gray Code

NB Natural Binary
Profi Profibus

PWM Pulse width Modulation
S/C Sin/Cos

SSI Serial Synchronous Interface

TB Terminal Box
X Excess Gray Code

Sensor Support Products

Mechanical Hardware



A wide range of couplings, mounting brackets, adapters, protective covers, and measuring wheels are available.

Cable and Cable Assemblies



Low capacitance data cables and cable assemblies are available in varying lengths and with multiple connector options.

Mating Connectors



A wide variety of mating connectors are available to interface with BEI Sensor products.

Inclinometers



BEI Sensors' sturdy and compact inclinometers offer high resolution, excellent sealing against harsh environments, and a variety of output options.

Draw Wire Solutions



Draw wire sensors offer a simple solution to measure linear speed and position. They are available in ranges from 1,200 and 50,000 mm in a variety of incremental and absolute output options.

Intrinsic Safety Barrier



This Galvanically Isolated Electronic Module is the perfect complement to BEI Sensors' intrinsically safe encoders. Together with our cable assemblies, they are a completely engineered solution for operation in Class I and Class II Division 1 Hazardous Environments. This single barrier provides both power and signal isolation for an incremental encoder with differential quadrature outputs and an index. This all-in-one approach saves the cost and inconvenience of buying separate power and signal barriers as required by other systems. This barrier is galvanically isolated and saves the added cost of maintaining a high integrity earth ground. With differential line driver outputs, this barrier can be used to carry signals up to 500 feet with a bandwidth of up to 250 kHz.

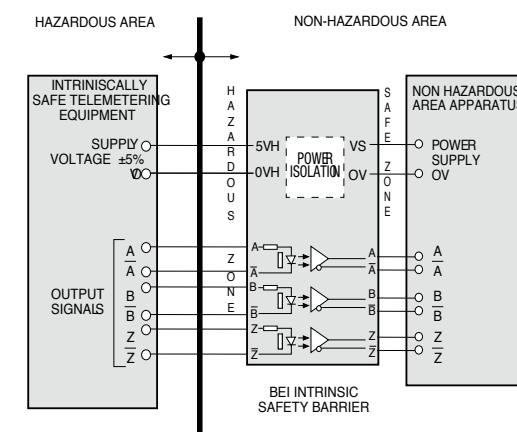

Note: This system diagram is for general information only.

Optical Isolator Module



This is a versatile interface between an incremental encoder and any receiving electronics. It accepts single ended or differential inputs and provides single ended or differential outputs in either an open collector or line driver configuration. It accommodates all standard

operating voltages from 5 to 28 VDC. Up to eight Optical Isolator Modules can be daisy-chained to provide multiple, simultaneous outputs to controllers or PLC's. This Optical Isolator can help clean up noisy signals by converting to a differential line driver output. It has a 1 MHz throughput capability and can be used wherever a fast, optically isolated interface is required.

Dual Encoder USB Interface



The Encoder USB Interface translates encoder position to industry standard USB 2.0 format that can be read by a computer. Each module can handle signals from two encoders. The module can be programmed through the USB interface for number of bits,

clock speed and position offset for absolute SSI encoders. For incremental encoders, count mode (X1, X2, X4), reset, preset, and preset/reset on index are programmable through the USB input. The Encoder USB interface is ideal for system setup and debugging, data acquisition and PC based control applications.

Anti-Dither Module



This module performs a specialized yet critical function for applications that may be subject to position errors due to stop/start cycles or vibration environments that are not using the direction-detection functions provided by a quadrature signal. It accepts A and

B signals and, through internal discrimination circuitry, passes the signals through only when there has been true movement of the encoder. This is especially useful in web processes, handling and inspection systems that use conveyors and simple speed control in applications that are subject to vibration.

Divide-By Module



This module accepts single ended or differential inputs and divides the signal by a factory set number from 2 to 256. The resulting output signal is a reduced resolution of the input signal. Ideal for use in machine retrofitting and

for applications where a different resolution output is needed from the same encoder source. When ordering, make sure to specify the divide-by amount in the model number.

Serial-to-Parallel Converter Module



The Serial-to-Parallel Converter takes serial data from either a SSI or RS-422 source and converts it to a 15 bit parallel output. This replaces the high cost and noise susceptibility of long, parallel

cable runs with the simplicity of a low cost twisted pair cable to interface to a parallel-input PLC or controller. Serial input type is selectable along with clock speed (for SSI) or baud (for RS422). This module accepts inputs from 5 to 28 VDC and has output options of $V_{out}=V_{in}$, $V_{out}=5V$ regulated or $V_{out} = \text{Open Collector}$.

Encoder Signal Broadcaster



The Encoder Signal Broadcaster accepts standard incremental encoder inputs, (two channels in quadrature plus an index and complements) and can broadcast up to four encoder

signals to four independent devices. Each of the broadcast signals is optically isolated. This compact package also allows for signal processing options, such as anti-dither filter, integer divide-by or pulse and direction outputs, to be incorporated into each of the four broadcast signals independently. The broadcaster is ideal for driving multiple receivers from a single encoder in applications like electronic line shafting or synchronization of multiple devices to a single operation.

SwiftComm™ Wireless Sensor Interface

A Secure, Robust Wireless Interface with Built-in Reliability Necessary for Real-Time Industrial Control

With the BEI SwiftComm wireless industrial sensor interface the machine designer is free to install sensor equipment without the expense and constraints of a hard-wired system. Installations in difficult applications like cranes, rotating tables or mobile applications, are greatly simplified.

The SwiftComm system includes the transmitter-receiver pair, which communicates using a point-to-point frequency-hopping 2.4 GHz RF protocol. Because of its flexible input/output electronics, it can interface with many different industrial sensors and control systems. Simply connect the SwiftComm transmitter to the sensor and the SwiftComm receiver to your control system and apply power. That's it. No complicated cabling is required.

SwiftComm's proprietary radio protocols include a broad security code range, data encryption, handshaking, interference recovery, and error checking. Ruggedness and flexibility are further enhanced with SwiftComm's NEMA 4 weatherproof enclosures, panel mounting options, antenna choices and wide-range DC power inputs. SwiftComm is available with an incremental or SSI output, or with an optional explosion proof transmitter housing.

Robust Signal

BEI's SwiftComm operates on the 2.4 GHz ISM radio band and uses Adaptive Frequency Hopping Protocol (AFH). This helps avoid data interruptions due to frequency interference. If a particular radio channel encounters interference, SwiftComm seamlessly hops to another open channel. To enhance RF link reliability even more, when SwiftComm detects interference on a channel, that channel is dropped from the hop sequence. If the available channels list ever becomes exhausted, previous dropped channels are retested to see if they are clear.

SwiftComm's patent pending technology can even overcome data loss due to link interruption. Internally and transparent to the user, SwiftComm keeps track of the sensor's output signal. If SwiftComm encounters packet loss from temporary link interruption, it fills in output information based on the historical data trend and processes this information in place of the lost packet. SwiftComm corrects for any accumulated error and seamlessly sends the corrected data to the controller. Even in environments where occasional packets are lost, SwiftComm will transmit a continuous stream of data to the control system.

Real Time Control

It is critical in any motion control application to have minimum lag time in signal transmission. SwiftComm is one of the fastest wireless sensor interfaces available. Data is relayed between the transmitter and receiver every 600 microseconds (μ s). Because SwiftComm is a point-to-point configuration, there is minimal latency.

Secure Transmission

SwiftComm provides a very secure system for data to travel wirelessly. The transmitter and receiver each have a 40-bit hard coded security code. These codes are programmed at the factory and give the system a range of over 500 billion possible unique codes. BEI has developed its own proprietary protocol for SwiftComm, which is not available to the public. Additionally, the data is transmitted with a high-level encryption algorithm and pseudo-random frequency hopping. This provides additional levels of data security to assure that your data is protected.

Long Range

Because motion control applications can vary widely, SwiftComm has a 50 mW radio for reliable long-range communication. In most open situations, a reliable link distance of up to 1,000 feet is possible. Inside buildings, a reliable link distance on the order of 300 feet can be expected.



Extensive Product Adaptability

BEI Sensors' exhaustive experience and capabilities in design, engineering and manufacturing allow us to provide innovative adapted products and complete custom solutions to meet unique position sensor requirements. For decades we have provided thousands of modifications to all our standard products. From customizations as simple as adding a connector or changing a shaft size to merging parts of two standard products, BEI takes pride in its ability to adapt to any customer's product needs.

Other adaptations require more significant changes, such as the modification of a product's size and shape so that it will fit into a particular package design. Complete customization, where the technology itself is adapted to meet a customer's requirements, is also fully within BEI's capabilities. Our experienced engineering team works closely with customers to help specify their requirements, outline a design, develop prototypes, and—after final customer approval—move the custom sensor into production.

BEI Sensors has the ability and willingness to make these types of modifications, ensuring that you will receive a position sensor configured to your specifications, allowing drop-in installation and simplifying production and assembly at your facility. If you are not finding exactly what you need in this catalog, just ask and we will be happy to create a customized solution with you.

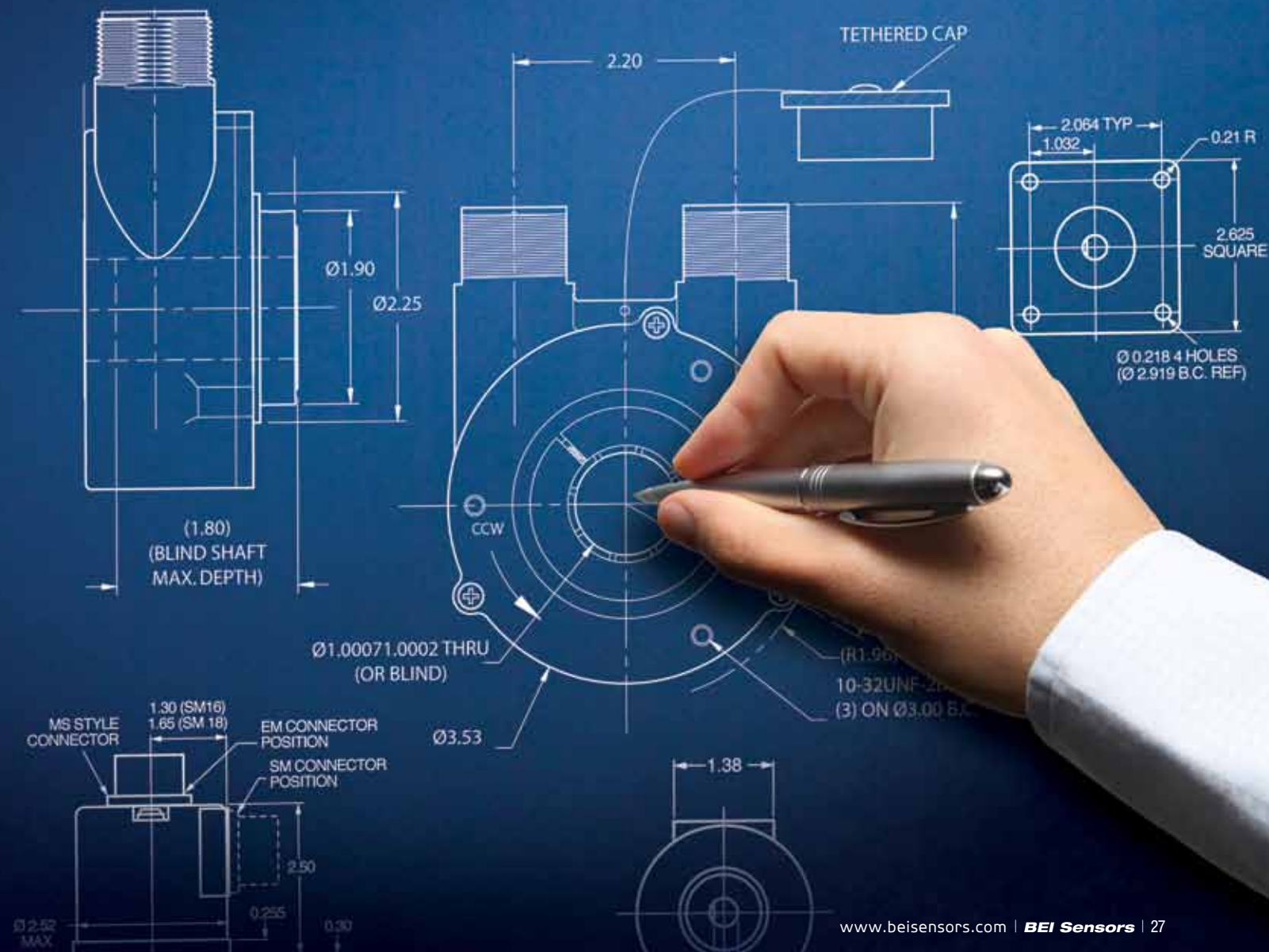

BEI SENSORS



Backed by Extensive International Resources

BEI Sensors is a brand of Custom Sensors & Technologies (CST) is a specialist in sensing, control and motion products. Through its brands—BEI Kimco, BEI Sensors, BEI PSSC, Crouzet, Crydom, Kavlico, Newall and Systron Donner Inertial—CST offers customizable, reliable and efficient components for mission-critical systems in Aerospace & Defense, Transportation, Energy & Infrastructures, Commercial & Industrial OEMs, Medical, Food and Beverage and Building Equipment markets.

Focused on premium value offers and committed to excellence, CST—with 4,700 employees worldwide and sales of \$660M US in 2011—is the dependable and adaptable partner for the most demanding customers. www.cstsensors.com

BEI SENSORS HEADQUARTERS

NORTH AMERICA

7230 Hollister Avenue | Goleta, CA 93117 USA
Tel: 800-350-2727 or 805-968-0782
Fax: 800-960-2726 or 805-968-3154
email: contact@beisensors.com
www.beisensors.com

EUROPE

9, rue de Copenhague
Espace Européen de l'Entreprise-Schiltigheim
BP 70044 - 67013 STASBOURG Cedex France
Tel: +33 (0)3-88-20-80-80 | Fax: +33 (0)3-88-20-87-87
email: info@beisensors.com | www.beisensors.com

WORLDWIDE SALES OFFICES

CHINA AND HONG KONG

Custom Sensors & Technologies Asia (Shanghai) Ltd.
13th Floor, Chang Feng International Tower
89 Yunling Road (East), Putuo District
Shanghai 200062 China
Tel: +86 (0)21 6065 7723 | Fax: +86 (0)21-6065-7749
email: china@cstsensors.com

INDIA

Custom Sensors & Technologies India
4th Floor, Trident Towers, No 23
100 Feet Road, Ashoka Pillar Road
2nd Block, Jaynagar, Bangalore 560 011 India
Tel: +91 80 41132204/05 | Fax: +91 80 41132206
email: india@cstsensors.com

KOREA

Custom Sensors & Technologies South Korea
5F, Jeil Bldg, 94-46 Youndeungpo-dong
7-ga Youngdeungpo-gu Seoul, 150-037 South Korea
Tel: +82 2 2629 8312 | Fax: +82 2 2629 8310
email: korea@cstsensors.com

BRAZIL

Custom Sensors & Technologies Latinoamerica
Alameda Rio Negro
1030 - cj.1803 - Alphaville
Barueri SP - CEP 06454-000 Brazil
Tel: +55 (11) 2505 7500 | Fax: +55 (11) 2505 7507
email: brasil@cstsensors.com

TAIWAN, JAPAN, SOUTHEAST ASIA, AND PACIFIC

Custom Sensors & Technologies South East Asia & Pacific
2F, No. 39, Ji-Hu Rd.
Nei-Hu Dist. Taipei 114 Taiwan
Tel: +886 (0) 2 8751 6388 | Fax: +886 (0)2 2657 8725
email: eap@cstsensors.com
email: taiwan@cstsensors.com

MEXICO

Custom Sensors & Technologies de Mexico
Calzada Zavaleta 2505-C, Santa Cruz Buenavista
Puebla 72150 Mexico
Tel: 222-409-7000; Fax: 222-409-7810
email: mexico@cstsensors.com