

Conduit & cable



Conduit & Cable



*Read safety/installation instruction sheets in packages before use.
These products are designed for positioning only. No load rating.*

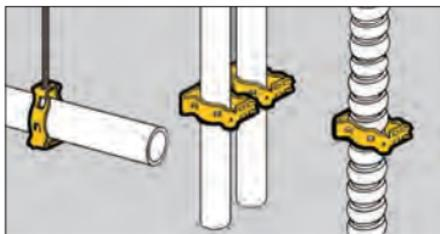

- Supports 3/8" to 2" conduit.
- Unique Guide-Rite™ Fastener provides for fast and easy installation with pliers.
- Now available in Dura-Copper™ finish - add DCU to part number.
- Static Load Capacity:
100 Lbs. - Vertical
25 Lbs. - Horizontal

Guide-Rite Conduit Fasteners



Clearance Hole
For 1/4" Bolt

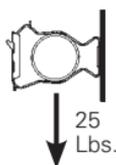

**Static
Load
Capacity**

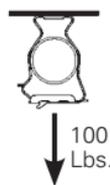

UPC/Part Number	Catalog Number	Conduit Size EMT/Rigid	Box Qty.
78101118350	BG-6*	3/8"	100
78101118355	BG-8-12	1/2", 3/4"	100
78101118360	BG-16	1"	100
78101118365	BG-20	1 1/4"	100
78101118360	BG-24	1 1/2"	100
78101118375	BG-32	2"	100



1/4"-20
Thread Impression



UPC/Part Number	Catalog Number	Conduit Size EMT/Rigid	Box Qty.
78101118380	BG-6-4T*	3/8"	100
78101118385	BG-8-12-4T	1/2", 3/4"	100
78101118390	BG-16-4T	1"	100
78101118395	BG-20-4T	1 1/4"	100
78101118400	BG-24-4T	1 1/2"	100
78101118405	BG-32-4T	2"	100

Patent #4958792

* BG-6 and BG-6-4T will accept the following range $\varnothing.420 - \varnothing.675$:
14/2 thru 10/4 MC/AC cable and 5/16" or 3/8" flexible conduit

Read safety/installation instruction sheets in packages before use.

Conduit & cable

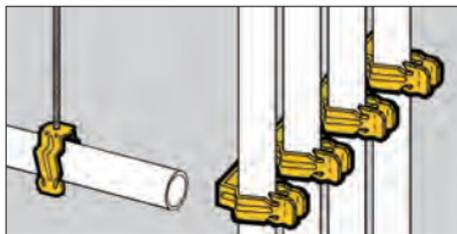

- Conduit easily snaps into push type fastener for secure support.
- Available with clearance hole for 1/4" bolt or 1/4"-20 thread impression.
- Ultimate Static Load Capacity:
25 Lbs. Vertical
15 Lbs. Horizontal

Push-Type Conduit Fasteners

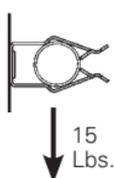

*Ultimate
Static Load
Capacity*

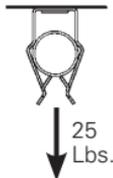

Clearance Hole
For 1/4" Bolt

UPC/Part Number	Catalog Number	Conduit Size	Box Qty.
78101119200	BP-8	1/2" EMT	100
78101119205	BP-12	3/4" EMT 1/2" IMC, Rigid	100
78101119210	BP-16	1" EMT 3/4" IMC, Rigid	100



1/4"-20
Thread Impression

UPC/Part Number	Catalog Number	Conduit Size	Box Qty.
78101119215	BP-8-4T	1/2" EMT	100
78101119220	BP-12-4T	3/4" EMT 1/2" IMC, Rigid	100
78101119225	BP-16-4T	1" EMT 3/4" IMC, Rigid	100

Read safety/installation instruction sheets in packages before use.

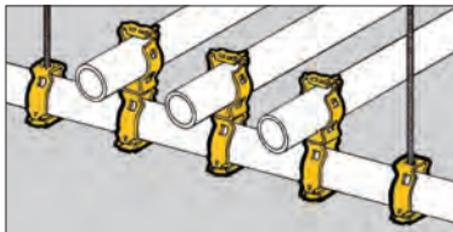

Guide-Rite Conduit Trapeze Fasteners



- For use with 3/8" to 2" conduit.
- Guide-Rite™ Fastener provides for fast and easy installation with pliers.



- Note: Total load of trapeze must not exceed 100 Lbs.

UPC/Part Number	Catalog Number	Conduit To 1" Trapeze	Box Qty.
78101118615	BG-16-G-6*	3/8"	100
78101118620	BG-16-G-8-12	1/2", 3/4"	100
78101118595	BG-16-G-16	1"	100
78101118600	BG-16-G-20	1 1/4"	50
78101118605	BG-16-G-24	1 1/2"	50
78101118610	BG-16-G-32	2"	50

* BG-16-G-6 will accept the following range Ø.420 - Ø.675: 14/2 thru 10/4 MC/AC cable and 5/16" or 3/8" flexible conduit

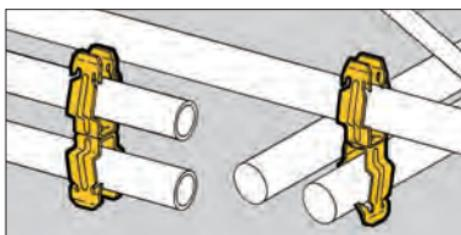

Push-Type Conduit To Conduit Fasteners

- An ideal spacer between conduits.
- No installation tools required.



- Ultimate Static Load Capacity: 25 Lbs.

UPC/Part Number	Catalog Number	Conduit Size	Box Qty.
78101118615	BP-8-P-8	1/2" to 1/2"	100
78101118620	BP-8-P-12	1/2" to 3/4"	100
78101118595	BP-8-P-16	1/2" to 1"	100
78101118600	BP-12-P-12	3/4" to 3/4"	100
78101118605	BP-12-P-16	3/4" to 1"	100
78101118610	BP-16-P-16	1" to 1"	100

Note: For rigid conduit with BP series, use next size larger fastener (1/2" Rigid use BP-12).

Read safety/installation instruction sheets in packages before use.

Conduit & cable

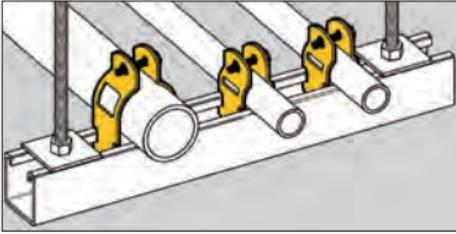

Break-Apart Conduit Clamps

- Patented Multi-Grip design fits Rigid, IMC or EMT conduit.
- Convenient break-apart clamp features retained bolt and $\frac{5}{16}$ " thread impression to eliminate handling of nuts and bolts.
- Finish: Pre-Galvanized.
- Static Load Capacity: 200 lbs.
- Recommended torque: 35 in-lbs.



BPC-8 thru BPC-32

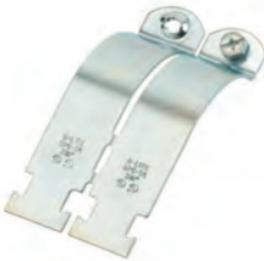

BPC-40 thru BPC-64

Static Load Capacity

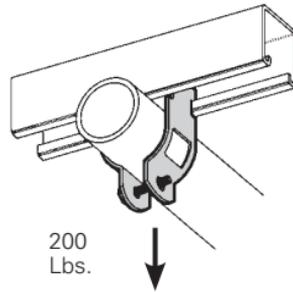

UPC/Part Number	Catalog Number	Rigid or EMT Conduit Size	Box Qty.
78101101676	BPC-8	$\frac{1}{2}$ "	100
78101101677	BPC-12	$\frac{3}{4}$ "	100
78101101680	BPC-16	1"	100
78101101679	BPC-20	$1\frac{1}{4}$ "	50
78101101678	BPC-24	$1\frac{1}{2}$ "	50
78101101681	BPC-32	2"	50
78101103977	BPC-40	$2\frac{1}{2}$ "	50
78101103978	BPC-48	3"	50
78101103979	BPC-56	$3\frac{1}{2}$ "	25
78101103981	BPC-64	4"	25

Patent #4044428

Read safety/installation instruction sheets in packages before use.

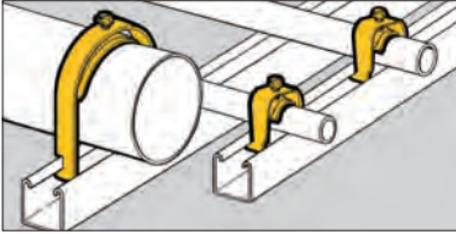

Conduit Strut Clamps



B1532S thru B1564S

B1506S
thru
B1524S



B1508
thru
B1520



- Attaches conduit, flexible conduit or cables to standard strut channels.
- B1506S designed to secure and support MC/AC cables.
- Unique one-piece design eliminates handling of hardware and allows easy installation and removal in side-by-side conduit runs.
- Anti-rock feature prevents clamp from disengaging during installation.
- Finish: Pre-Galvanized.

UPC/Part Number	Catalog Number	Conduit Size		OD Range Inches		Static Load Cap. Lbs.	Box Qty.
		EMT	Rigid	Min	Max		
78101163150	B1508	½"	–	–	–	200	100
78101163154	B1512	¾"	½"	–	–	200	100
78101163157	B1516	1"	¾"	–	–	200	100
78101163160	B1520	1¼"	1"	–	–	200	100
Note: Clamps without saddle are not recommended for flexible conduit or cable							
78205144495	B1506S*	⅜"*	–	.400	.630	200	100
78101163164	B1508S	½"	–	.250	.680	200	100
78101163168	B1512S	¾"	½"	.500	.840	200	100
78101163171	B1516S	1"	¾"	.750	1.050	200	100
78101163177	B1520S	1¼"	1"	1.125	1.315	200	100
78101163182	B1524S	1½"	1¼"	1.375	1.660	350	50
78101163188	B1532S	2"	1½"	1.875	2.200	400	50
78101163193	B1534S	–	2"	2.125	2.375	400	25
78101163199	B1540S	2½"	2½"	2.625	2.875	400	25
78101163205	B1548S	3"	3"	3.250	3.500	400	25
78101163211	B1556S	3½"	3½"	3.750	4.000	400	10
78101163215	B1564S	4"	4"	4.250	4.500	400	10

Patent #5022614

- * B1506S will accept the following
 AC Cable 14/2, 14/3, 14/4, 12/2, 12/3, 12/4, 10/2, 10/3, 10/4
 MC Cable 14/2, 14/3, 14/4, 12/2, 12/3, 12/4, 10/2, 10/3, 10/4

Read safety/installation instruction sheets in packages before use.

Conduit & cable

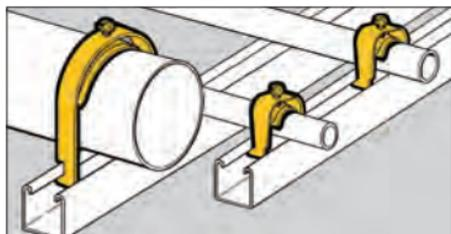

- One-piece assembled product.
- Easy removal without disconnecting adjacent clamps.
- Secure cables easily with protective saddle, preventing damage to conduit or cable.
- One-hand installation.

Conduit & cable clamps



- Clamp works on equal trade sizes for both EMT and rigid conduit.
- Attaches to cable tray rungs and strut profiles; securing conduit, flexible conduit and cable to cable tray or traditional strut and open channel side of 4Dimension™ 4D22 strut system.
- Available in Pre-Galvanized, stainless steel 316.

UPC/Part Number	Catalog Number	Conduit Size		Static Load Cap. Lbs.	Box Qty.
		EMT & Rigid	OD Range Inches Min Max		
Pre-Galvanized steel					
79903860162	BL050	½"	0.65 0.89	200	100
79903860163	BL075	¾"	0.86 1.11	200	100
79903860164	BL100	1"	1.1 1.4	200	100
79903860165	BL125	1¼"	1.4 1.725	200	50
79903860166	BL150	1½"	1.69 1.98	200	50
79903860168	BL200	2"	1.98 2.576	200	50
79903860169	BL250	2½"	2.576 3.06	350	25
79903860170	BL300	3"	3.06 3.626	350	25
79903860171	BL350	3½"	3.626 4.126	350	25
79903860172	BL400	4"	4.126 4.626	350	25
Stainless steel 316					
79903860173	BL050SS6	½"	0.65 0.89	200	100
79903860174	BL075SS6	¾"	0.86 1.11	200	100
79903860175	BL100SS6	1"	1.1 1.4	200	100
79903860176	BL125SS6	1¼"	1.4 1.725	200	50
79903860177	BL150SS6	1½"	1.69 1.98	200	50
79903860178	BL200SS6	2"	1.98 2.576	200	50
79903860179	BL250SS6	2½"	2.576 3.06	350	25
79903860180	BL300SS6	3"	3.06 3.626	350	25
79903860181	BL350SS6	3½"	3.626 4.126	350	25
79903860182	BL400SS6	4"	4.126 4.626	350	25

Read safety/installation instruction sheets in packages before use.

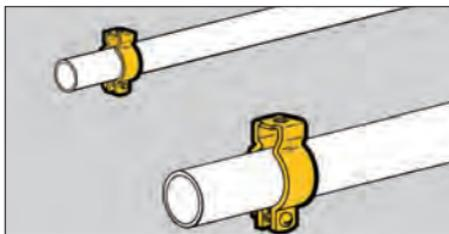

- For use with 1/2" thru 4" Conduit.
- Static Load Capacity: 400 lbs.
- Now available in Dura-Copper™ finish - add DCU to part number.
- Finish: Zinc-Plated.

Conduit Hangers



With Retained Bolt and Thread Impression

UPC/Part Number	Catalog Number	Trade Size	Conduit Size EMT	Conduit Size Rigid	Box Qty.
78101119800	BL1400*	0	1/2"	1/2"	100
78101119801	BL1410*	1	3/4"	3/4"	100
78101119802	BL1420*	2	1"	1"	100



With Bolt and Nut

UPC/Part Number	Catalog Number	Trade Size	Conduit Size EMT	Conduit Size Rigid	Box Qty.
78101119803	BL1425*	2.5	1 1/4"	—	100
78101119804	BL1430*	3	1 1/2"	1 1/4"	100
78101119805	BL1440†	4	—	1 1/2"	50
78101119806	BL1450†	5	2"	2"	50
78101119807	BL1460†	6	2 1/2"	2 1/2"	25
78101119808	BL1470†	7	3"	3"	25
78101119809	BL1480†	8	3 1/2"	3 1/2"	10
78101119810	BL1490†	9	4"	4"	10

* 9/32" mounting hole. † 11/32" mounting hole.

Read safety/installation instruction sheets in packages before use.

Conduit & cable

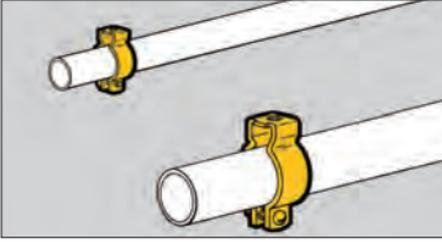

- For use with 1/2" thru 4" Conduit.
- Static Load Capacity: 400 lbs.
- Material: Type 304 Stainless Steel.

Stainless Steel Conduit Hangers



With Bolt And Nut

UPC/Part Number	Catalog Number	Trade Size	Conduit Size EMT	Size Rigid	Box Qty.
78101119800	BL1400-SS4*	0	1/2"	1/2"	100
78101119801	BL1410-SS4*	1	3/4"	3/4"	100
78101119802	BL1420-SS4*	2	1"	1"	100
78101119803	BL1425-SS4*	2.5	1 1/4"	--	100
78101119804	BL1430-SS4*	3	1 1/2"	1 1/4"	100
78101119805	BL1440-SS4†	4	--	1 1/2"	50
78101119806	BL1450-SS4†	5	2"	2"	50
78101119807	BL1460-SS4†	6	2 1/2"	2 1/2"	25
78101119808	BL1470-SS4†	7	3"	3"	25
78101119809	BL1480-SS4†	8	3 1/2"	3 1/2"	10
78101119810	BL1490-SS4†	9	4"	4"	10

* 9/32" mounting hole. † 1 1/32" mounting hole.

Read safety/installation instruction sheets in packages before use.

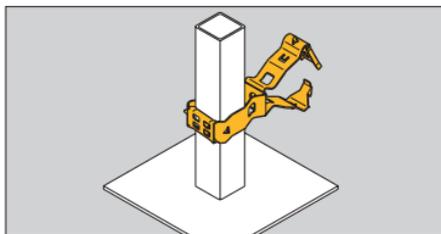

- Supports conduit from square computer floor pedestals.
- Unique Guide-Rite™ Fastener provides for fast and easy installation with pliers.
- Static Load Capacity: 25 lbs.

Guide-Rite Conduit To Pedestal Support



UPC/Part Number	Catalog Number	Conduit Size EMT/Rigid	Box Qty.
78205125589	BG-8-12-G6*	3/8"	100
78101188538	BG-8-12-G812	1/2" or 3/4"	100
78101118620	BG-16-G-8-12	1"	100
78205125594	BG-8-12-G20	1 1/4"	50
78205125595	BG-8-12-G24	1 1/2"	50
78205125597	BG-8-12-G32	2"	50

Patent #4958792

- * BG-8-12-G6 will accept the following range $\varnothing.420 - \varnothing.675$:
14/2 thru 10/4 MC/AC cable and 5/16" or 3/8" flexible conduit

Read safety/installation instruction sheets in packages before use.

Conduit & cable

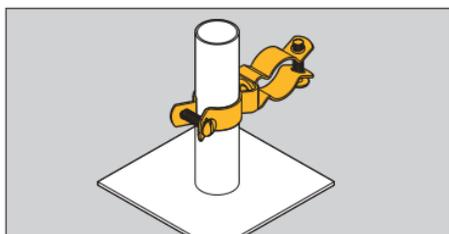

- Supports conduit from 1" O.D. computer floor pedestals.
- Also available in Type 304 Stainless Steel. Contact factory for details.
- Static Load Capacity: 25 lbs.
- Finish: Zinc-Plated.

Conduit To Pedestal Support



UPC/Part Number	Catalog Number	Trade Size	Conduit Size		Box Qty.
			Rigid	EMT	
78205125599	BL1410-L1400	0	½"	½"	50
78205125601	BL1410-L1410	1	¾"	¾"	50
78205125602	BL1410-L1420	2	1"	1"	50
78205125603	BL1410-L1425	2.5	–	1¼"	50
78205125607	BL1410-L1430	3	1¼"	1½"	50
78205125612	BL1410-L1440	4	1½"	–	25
78205125614	BL1410-L1450	5	2"	2"	25
78205125617	BL1410-L1460	6	2½"	2½"	10
78205125618	BL1410-L1470	7	3"	3"	10
78205125619	BL1410-L1480	8	3½"	3½"	5

Read safety/installation instruction sheets in packages before use.

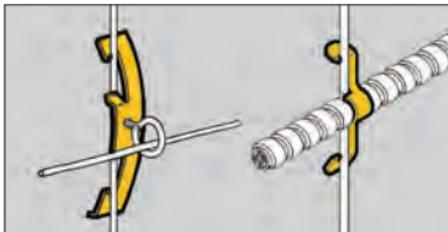

Rod & Wire Fasteners



- BW2 and BW6 support #10-24 or 1/4"-20 threaded bridle rings and provide attachment for electrical boxes.
- BW2S & BW6S are provided with one each 1/4"-20 x 3/8" screw and hex nut.
- BW4 supports cables from #12 thru #8 wire.

UPC/Part Number	Catalog Number	Drop Rod/ Wire Size	Flange Thickness	Box Qty.
78101119700	BW2	#12 wire thru 1/4" plain or threaded rod	1/8" - 3/8"	100
78205140156	BW2S	#12 wire thru 1/4" plain or threaded rod	1/8" - 3/8"	100
78101195516	BW6	3/8" plain or threaded rod	3/8" - 7/16"	100
78205140157	BW6S	3/8" plain or threaded rod	3/8" - 7/16"	100

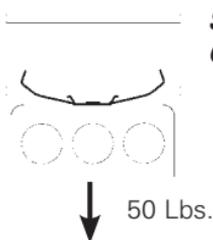

Static Load Capacity



UPC/Part Number	Catalog Number	Description	Box Qty.
78101119705	BW4	Multi-size Wire Fastener	100



MC/AC Cable Size	#12 Wire	#10 Wire	#8 & #9 Wire
14/2 Cable	BW4	BW4	BW4
14/3 Cable	BW4	BW4	BW4
12/2 Cable	BW4	BW4	BW4
12/3 Cable	BW4	BW-8	BW-8

BW4 is designed for positioning only. No load rating.

Note: An independent means of support is required by NEC Article 300.11.

Read safety/installation instruction sheets in packages before use.

Conduit & cable

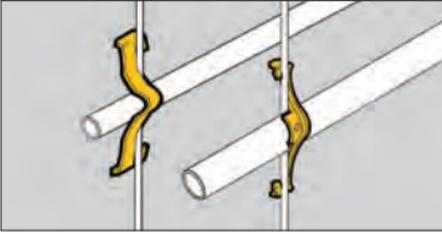

- See BX8 and BX18 for a better solution.
- Attaches conduit to wire rods or flanges.
- Can be used for flexible metallic tubing or armored cable.

Rod & Wire Fasteners



BW-8



BW-16

UPC/Part Number	Catalog Number	Box Qty.
78101119710	BW-8	100
78101119715	BW-12	100
78101119720	BW-16	100
78101119725	BW-20	100

Conduit & Cable

Conduit Size	#10 & #12 Wire	#8 & #9 Wire	3/16" & 1/4" Rod	1/8" to 1/4" Flange	5/16" to 3/8" Flange	7/16" to 1/2" Flange
1/2" EMT	BW-8	BW-8	BW-8	BW-8	BW-12	BW-12
1/2" Rigid	BW-8	BW-12	BW-12	BW-12	BW-12	BW-16
3/4" EMT	BW-12	BW-12	BW-12	BW-12	BW-16	BW-16
3/4" Rigid	BW-12	BW-12	BW-16	BW-16	BW-20*	BW-20*
1" EMT	—	BW-16	BW-16	BW-16	BW-20*	BW-20*
1" Rigid	—	—	—	BW-20*	BW-20*	BW-20*
1 1/4" EMT	—	BW-20	BW-20	BW-20	—	—

*Note: For horizontal applications only.

Static Load Capacity

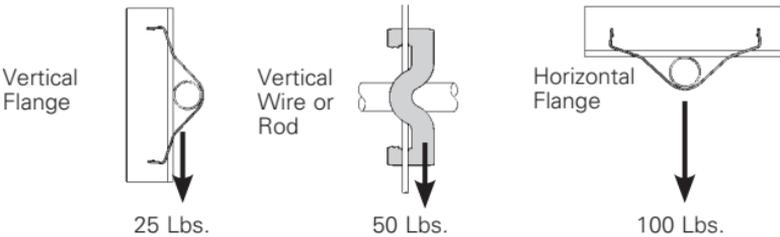

Note: An independent means of support is required by NEC Article 300.11.

Read safety/installation instruction sheets in packages before use.

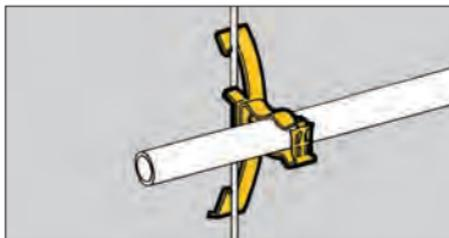

- Assemblies support 1/2", 3/4" and 1" conduit.
- W2 series attaches to 1/8" thru 3/8" flanges or #12 wire thru 1/4" plain or threaded rod.
- W6 series attaches to 3/8" thru 7/16" flanges or 3/8" plain or threaded rod.

Guide-Rite™ Conduit To Rod Fasteners



UPC/Part Number	Catalog Number	Conduit Size EMT/Rigid	Box Qty.
78101118540	BG-8-12-W2	1/2", 3/4"	100
78101118640	BG-16-W2	1"	100
78101195519	BG-8-12-W6	1/2", 3/4"	100
78101195520	BG-16-W6	1"	100

Patent #4958792

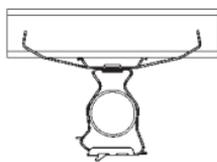

50 Lbs.

Static Load Capacity

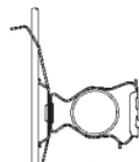

25 Lbs.

Note: An independent means of support is required by NEC Article 300.11.

Read safety/installation instruction sheets in packages before use.

Conduit & cable

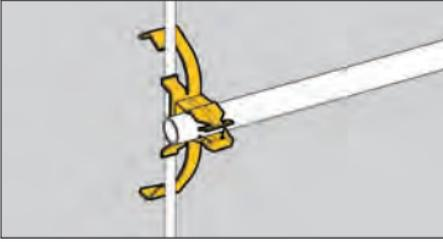

- Assemblies support ½", ¾" and 1" conduit.
- W2 series attaches to ⅛" thru ⅜" flanges or #12 wire thru ¼" plain or threaded rod.
- W6 series attaches to ⅜" thru ⅞" flanges or ⅜" plain or threaded rod.

Push-Type Conduit To Rod Fasteners



Conduit & Cable

UPC/Part Number	Catalog Number	Conduit Size	Box Qty.
78101119325	BP-8-W2	½" EMT	100
78101119420	BP-12-W2	¾" EMT or ½" IMC. Rigid	100
78101119505	BP-16-W2	1" EMT or ¾" IMC, Rigid	100
78101195521	BP-8-W6	½" EMT	100
78101195522	BP-12-W6	¾" EMT or ½" IMC. Rigid	100
78101195523	BP-16-W6	1" EMT or ¾" IMC, Rigid	100

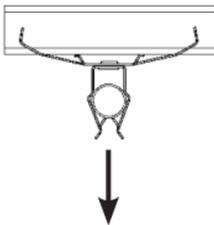

25 Lbs.

Ultimate Static Load Capacity

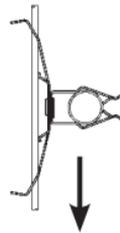

15 Lbs.

Note: An independent means of support is required by NEC Article 300.11.

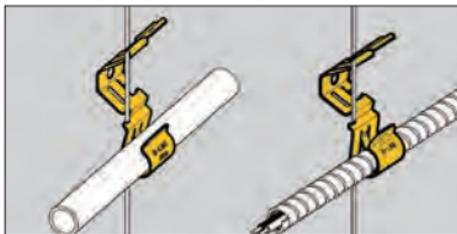

Flex-Rite Cable/Conduit To Wire Fasteners



- Flex-Rite™ can be used in place of batwings.
- Will not bend or deform hanger wire.
- Attaches to #12 - #8 wire and 1/4" plain rod.
- Accommodates MC, AC, 3/8" FMC or 1/2" EMT.
- Cable can be installed before or after attachment to wire.
- Static Load Capacity:
BX-8 - 20 Lbs.
BX-18 - 30 Lbs.

UPC/Part Number	Catalog Number	Cable/Conduit Size	Box Qty.
78101101402	BX-8	.375" to 706" O.D.	100
78101102943	BX-18	.706" to 1.380" O.D.	100
78101101685	BX-8B	Bulk Packed In Fiber Barrels	4000

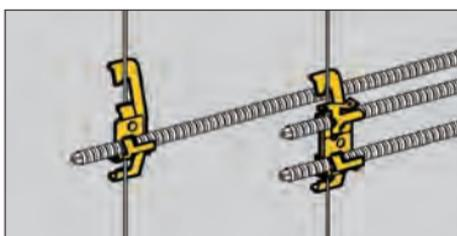

Cable To Rod Fasteners



BX4-W2



BX4M-W2

- Assemblies support MC, AC, sizes 14/2 through 10/3 or 3/8 FMC.
- W2 series attaches to 1/8" thru 3/8" flanges or #12 wire thru 1/4" plain or threaded rod.
- W6 series attaches to 3/8" thru 7/16" flanges or 3/8" plain or threaded rod.

UPC/Part Number	Catalog Number	Description	Box Qty.
78101101219	BX4-W2	Single Runs	100
78101101189	BX4M-W2	Double Runs	100
78101195517	BX4-W6	Single Runs	100
78101195518	BX4M-W6	Double Runs	100

Read safety/installation instruction sheets in packages before use.

Conduit & cable

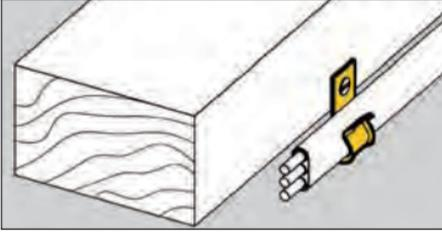

- Attaches Type NM cable to most structures.
- Supports cable sizes 14/2 and 12/2 with ground wire.
- May be used with other B-Line series fasteners for attachment to acoustical tees, beams, drop wires, etc.

Cable Fasteners



UPC/Part Number	Catalog Number	Description	Box Qty.
78101103553	BRC3	Type NM Cable Fastener	100

Conduit & Cable

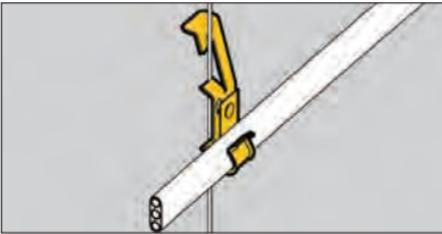

- Supports cable sizes 14/2 and 12/2 with ground wire.
- W2 series supports cable from #12 wire thru 1/4" plain or threaded rod.
- W6 series supports cable from 3/8" plain or threaded rod.

Cable Fasteners



UPC/Part Number	Catalog Number	Description	Box Qty.
78101103547	BRC3-W2	Type NM Cable To Wire Fastener	100
78101195524	BRC3-W6	Type NM Cable To Wire Fastener	100

Read safety/installation instruction sheets in packages before use. These products are designed for positioning only. No load rating.

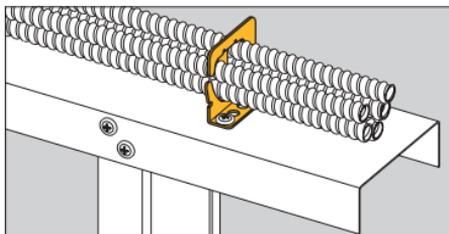

Multi-Run Cable Carrier for MC/AC Cable



BRC5-1



BRC5-2



BRC5-3



- Secures and supports multiple runs of MC/AC cable as required by the NEC.
- Effectively organizes cables and eliminates derating issues.
- Retention tab is open for easy loading and unloading and contains cables when bent in place.
- Compatible with new BCH-HBA for multi tier assemblies.
- Load Capacity: 50 lbs.
- Finish: Zinc Plated.

UPC/Part Number	Catalog Number	Cable Diameter & Number Of Runs	Box Qty.
78205143593	BRC5-1	.430" to .560" Up To 4 Runs	50
78205143594	BRC5-2	.430" to .560" Up To 9 Runs	50
78205143595	BRC5-3	.560" to .690" Up To 7 Runs	50

Read safety/installation instruction sheets in packages before use.

Conduit & cable

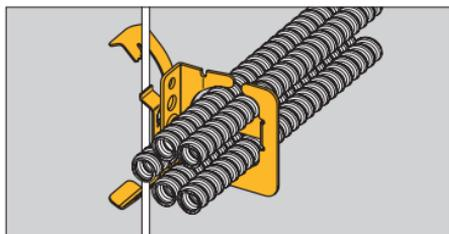

Multi-Run Cable Carrier for MC/AC Cable

- Secures and supports multiple runs of MC/AC cable as required by the NEC.
- W2 Series attaches to 1/8" thru 3/8" flanges or #12 thru 1/4" plain or threaded rod.
- W6 Series attaches to 3/8" thru 7/16" flanges or 3/8" plain or threaded rod.
- Load Capacity: 50 lbs.
- Finish: Zinc Plated.



UPC/Part Number	Catalog Number	Cable Diameter & Number Of Runs	Box Qty.
78205144075	BRC51-W2	.430" to .560" Up To 4 Runs	25
78205144076	BRC52-W2	.430" to .560" Up To 9 Runs	25
78205144077	BRC53-W2	.560" to .690" Up To 7 Runs	25
78205144078	BRC51-W6	.430" to .560" Up To 4 Runs	25
78205144079	BRC52-W6	.430" to .560" Up To 9 Runs	25
78205144080	BRC53-W6	.560" to .690" Up To 7 Runs	25

Note: An independent means of support is required by NEC Article 300.11.

*Read safety/installation instruction sheets in packages before use.
These products are designed for positioning only. No load rating.*

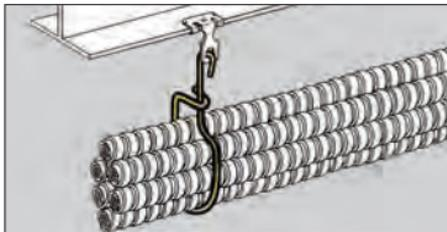

- Designed to support multiple runs of MC, AC, FMC or communication cable.
- Static Load Capacity:
BX2 - 50 lbs.
BX6 & BX24 - 75 Lbs.
- Finish: Zinc Plated.

Flexible Cable Support



BX2

BX6

UPC/Part Number	Catalog Number	Description	Box Qty.
78205104934	BX2	Usable Area = 2 sq. in.	100
78205119765	BX6	Usable Area = 4 sq. in.	100
78205119766	BX24	Usable Area = 13 sq. in.	100

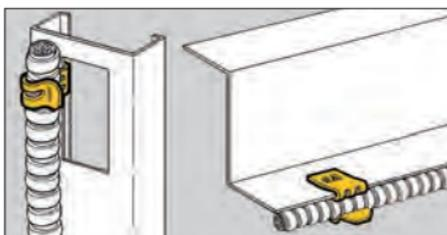

- Fastens flexible conduit and other small cables to beam flanges, bar joists or metal studs.
- Cable O.D. range of 0.42" to 0.70".
- Maximum flange thickness $\frac{5}{32}$ ".

Flexible Conduit/Cable Fasteners



UPC/Part Number	Catalog Number	Description	Box Qty.
78101119770	BX9	Flexible Conduit Fastener	100

Read safety/installation instruction sheets in packages before use.

Conduit & cable

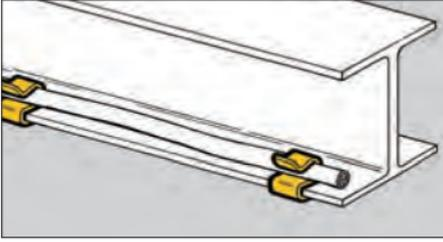

- Secures cable along flanges 1/16" to 3/4"
- The BFA flange adapters attach BXS series to thicker flanges.
- BX_-67 accepts 14/2, 12/2 & 10/2 romex with ground.
- BX_-1011 accepts 14/2, 12/2 & 10/2 romex with ground.
- BX_-1214 accepts 10/3, romex with ground.
- Finish: Zinc Plated.

Flexible Conduit/ Cable Fasteners



BFA Series
(For Use with
BXS Series Only)



BXS
Series



BXL
Series

UPC/Part Number	Catalog Number	Flange Thickness	Cable Diameter	Box Qty.
78101119973	BXS-67	1/16" - 5/32"	.218 to .281	100
78101119974	BXS-89	1/16" - 5/32"	.290 to .375	100
78101119975	BXS-1011	1/16" - 5/32"	.375 to .437	100
78101119976	BXS-1214	1/16" - 5/32"	.444 to .560	100
78101119977	BXS-1519	1/16" - 5/32"	.500 to .718	100
78101119978	BXS-2024	1/16" - 5/32"	.748 to .945	100
78101119979	BXS-2530	1/16" - 5/32"	.968 to 1.250	100
78101119980	BXM-67	5/32" - 9/32"	.218 to .281	100
78101119981	BXM-89	5/32" - 9/32"	.290 to .375	100
78101119982	BXM-1011	5/32" - 9/32"	.375 to .437	100
78101119983	BXM-1214	5/32" - 9/32"	.444 to .560	100
78101119984	BXM-1519	5/32" - 9/32"	.500 to .718	100
78101119985	BXM-2024	5/32" - 9/32"	.748 to .945	100
78101119986	BXM-2530	5/32" - 9/32"	.968 to 1.250	100
78101119987	BXL-67	5/16" - 1/2"	.218 to .281	100
78101119988	BXL-89	5/16" - 1/2"	.290 to .375	100
78101119989	BXL-1011	5/16" - 1/2"	.375 to .437	100
78101119990	BXL-1214	5/16" - 1/2"	.444 to .560	100
78101119991	BXL-1519	5/16" - 1/2"	.500 to .718	100
78101119992	BXL-2024	5/16" - 1/2"	.748 to .945	100
78101119993	BXL-2530	5/16" - 1/2"	.968 to 1.250	100
78101119955	BFA-1215	1/2" - 5/8"	—	100
78101119956	BFA-1520	5/8" - 3/4"	—	100

Read safety/installation instruction sheets in packages before use.
These products are designed for positioning only. No load rating.

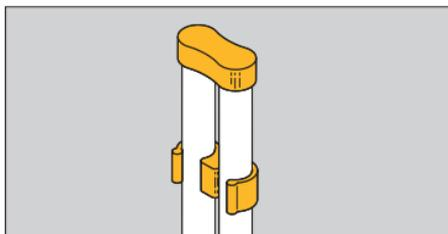

Conduit Quick Caps & Spacers



BCS & BES
8 & 8C thru 16
& 16C



BCS 12AS & 16AS

BCS 18, 18C, 20, & 20C

- Quick caps and spacers eliminate the time consuming method of duct taping conduit stubs.
- Quick spacers are designed to separate and secure conduit during concrete pours.
- Quick caps maintain spacing and keep conduit free from dirt and debris.
- Quick caps and spacers properly space conduit for any 4" square box.
- Available in EMT & Rigid conduit sizes.

UPC/Part Number	Catalog Number	Conduit Size	Box Qty.
Conduit Spacer			
78205122356	BCS-8	½" Rigid Conduit	50
78205140057	BES-8	½" EMT Conduit	50
78205122357	BCS-12	¾" Rigid Conduit	50
78205140058	BES-12	¾" EMT Conduit	50
78205122358	BCS-16	1" Rigid Conduit	50
78205140059	BES-16	1" EMT Conduit	50
79903855806	BCS-18	1½" Rigid Conduit	25
79903855807	BCS-20	2" Rigid Conduit	25
Conduit Cap			
78205122359	BCS-8C	½" Rigid Conduit	50
78205140060	BES-8C	½" EMT Conduit	50
78205122361	BCS-12C	¾" Rigid Conduit	50
78205140061	BES-12C	¾" EMT Conduit	50
78205122362	BCS-16C	1" Rigid Conduit	50
78205140062	BES-16C	1" EMT Conduit	50
79903855803	BCS-18C	1½" Rigid Conduit	25
79903855805	BCS-20C	2" Rigid Conduit	25
Conduit Spacer			
79903855808	BCS-12AS	¾" Rigid Conduit	50
79903855809	BCS-16AS	1" Rigid Conduit	25

Patent #5896892

Read safety/installation instruction sheets in packages before use.

Conduit & cable

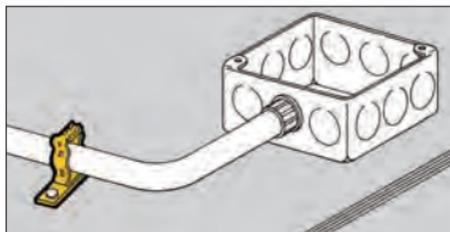

- Helps eliminate the need for offset bends when used with 1 1/2" deep boxes.
- Attaches conduit to concrete, steel or wood with nails.
- May be attached after conduit positioning.

Conduit Spacer Brackets



BG



BP

UPC/Part Number	Catalog Number	Conduit Size	Box Qty.
78101118495 Patent # 4958792	BG-8-12-D3	1/2" or 3/4"	100
78101119265	BP-8-D3	1/2" EMT	100
78101118365	BP-12-D3	3/4" EMT or 1/2" IMC, Rigid	100

Conduit & Cable

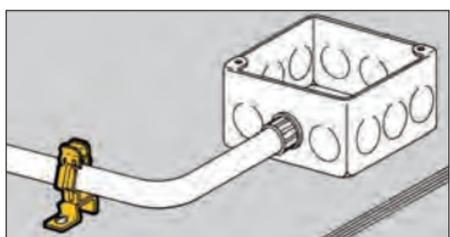

- Helps eliminate the need for offset bends when used with 2 1/2" deep boxes.
- Provides secure support between conduit and deck.
- D4 series is easily installed with screw gun or powder actuated tools.
- Allows for complete conduit layout prior to anchoring.

Conduit Spacer Brackets



BG



BP

UPC/Part Number	Catalog Number	Conduit Size	Box Qty.
78101118500 Patent # 4958792	BG-8-12-D4	1/2" or 3/4"	100
78101119270	BP-8-D4	1/2" EMT	100
78101119370	BP-12-D4	3/4" EMT or 1/2" IMC, Rigid	100
78101119460	BP-16-D4	1" EMT or 3/4" IMC, Rigid	100

Read safety/installation instruction sheets in packages before use.

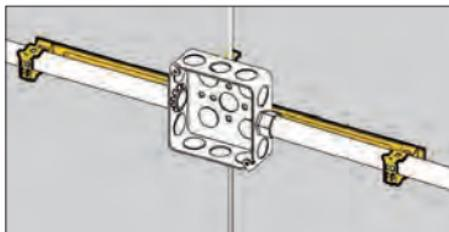

Guide-Rite™ Conduit & Box Support Fasteners



- See Ruff-IN™ pages for pre-fab box assemblies.

- BMC3 plate supports multiple conduit runs.
- Riveted assembly provides support for electrical boxes and conduit runs on either side of the box.
- Helps reduce drop wires by up to 66% when using W2/W6 assemblies.
- Assemblies using BMC3 plate include center conduit clip. Additional conduit clips may be purchased separately.



BG__S18



BG__S18-MC3

UPC/Part Number	Catalog Number	Conduit Size EMT & Rigid	Box Qty.
78101103575	BG6-S18 *	3/8"	25
78101103573	BG812-S18	1/2" or 3/4"	25
78101103574	BG16-S18	1"	25

With Multiple Conduit Plate

78205152812	BG6-S18-MC3 *	3/8"	25
78205152900	BG812-S18-MC3	1/2" or 3/4"	25
78205152901	BG16-S18-MC3	1"	25

Patent # 4958792



BG__S18-S
With 1/4"-20 x 5/8" Stud



BG__S18-S-MC3
With 1/4"-20 x 5/8" Stud

With Stud

78205152902	BG6-S18S *	3/8"	25
78110104979	BG812-S18S	1/2" or 3/4"	25
78205152903	BG16-S18S	1"	25

With Stud & Multiple Conduit Plate

78205152904	BG6-S18S-MC3 *	3/8"	25
78205152905	BG812-S18S-MC3	1/2" or 3/4"	25
78205152906	BG16-S18S-MC3	1"	25

* BG-6 will accept the following range \varnothing .420 - \varnothing .675:
14/2 thru 10/4 MC/AC cable and 5/16" or 3/8" flexible conduit

Read safety/installation instruction sheets in packages before use.

Conduit & cable



BG_-S18-W_



BG_-S18-W-MC3

UPC/Part Number	Catalog Number	Conduit Size EMT & Rigid	Box Qty.
-----------------	----------------	--------------------------	----------

W2 Series for #12 thru 1/4" Rod **

78101103578	BG6-S18-W2 *	3/8"	25
78101103577	BG812-S18-W2	1/2" or 3/4"	25
78101103577	BG16-S18-W2	1"	25

W2 Series for #12 thru 1/4" Rod & Multiple Conduit Plate **

78205152855	BG6-S18-W2-MC3 *	3/8"	25
78205152739	BG812-S18-W2-MC3	1/2" or 3/4"	25
78205152862	BG16-S18-W2-MC3	1"	25

W6 Series for 3/8" Plain or Threaded Rod **

78110199581	BG6-S18-W6 *	3/8"	25
78110199582	BG812-S18-W6	1/2" or 3/4"	25
78110199580	BG16-S18-W6	1"	25

W6 Series for 3/8" Plain or Threaded Rod & Multiple Conduit Plate **

78205152856	BG6-S18-W6-MC3 *	3/8"	25
78205152860	BG812-S18-W6-MC3	1/2" or 3/4"	25
78205152864	BG16-S18-W6-MC3	1"	25

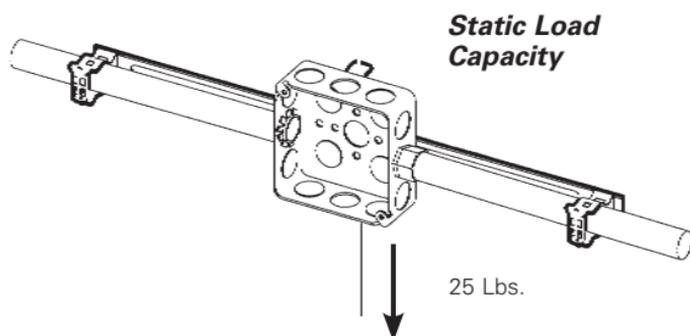

* BG-6 will accept the following range $\varnothing.420 - \varnothing.675$:
14/2 thru 10/4 MC/AC cable and 5/16" or 3/8" flexible conduit

** Note:

An independent means of support is required by NEC Article 300.11.

Read safety/installation instruction sheets in packages before use.

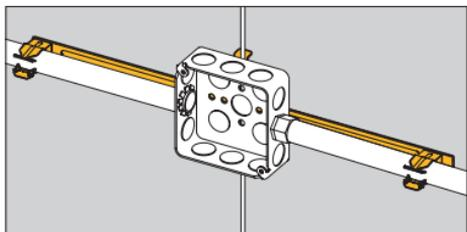

Push-Type Conduit & Box Support Fasteners

- See the Ruff-IN™ brochure for pre-fab box assemblies.

- New BMC3 plate is available to support multiple conduit runs.
- Riveted assembly provides support for electrical boxes and conduit runs on either side of the box.
- Reduces drop wires by up to 66% when using W2/W6 assemblies.
- Assemblies using BMC3 plate include center conduit clip. Additional conduit clips may be purchased separately.



BP__-S18



BP__-S18-MC3

UPC/Part Number	Catalog Number	Conduit Size E(EMT) R(Rigid)	Box Qty.
78205123604	BP8-S18	1/2" E	25
78205123605	BP12-S18	3/4" E or 1/2" R	25
78205123606	BP16-S18	1"E, 3/4" R	25

With Multiple Conduit Plate

78205152907	BP8-S18-MC3	1/2" E	25
78205152908	BP12-S18-MC3	3/4" E or 1/2" R	25
78205152909	BP16-S18-MC3	1"E, 3/4" R	25



BP__-S18-S
With 1/4"-20 x 5/8"
Stud



BP__-S18-S-MC3
With 1/4"-20 x 5/8"
Stud

With Stud

78205123631	BP8-S18S	1/2" E	25
78205123633	BP12-S18S	3/4" E or 1/2" R	25
78205123634	BP16-S18S	1"E, 3/4" R	25

With Stud & Multiple Conduit Plate

78205152913	BP8-S18S-MC3	1/2" E	25
78205152914	BP12-S18S-MC3	3/4" E or 1/2" R	25
78205152915	BP16-S18S-MC3	1"E, 3/4" R	25

Read safety/installation instruction sheets in packages before use.

Conduit & cable



BG__S18-W_



BG__S18-W_MC3

UPC/Part Number	Catalog Number	Conduit Size E(EMT) R(Rigid)	Box Qty.
-----------------	----------------	---------------------------------	----------

W2 Series for #12 thru 1/4" Rod **

78205123615	BP8-S18-W2	1/2" EMT	25
78205123619	BP12-S18-W2	3/4" E or 1/2" R	25
78205123627	BP16-S18-W2	1"E, 3/4" R	25

W2 Series for #12 thru 1/4" Rod & Multiple Conduit Plate **

78205152847	BP8-S18-W2-MC3	1/2" EMT	25
78205152848	BP12-S18-W2-MC3	3/4" E or 1/2" R	25
78205152849	BP16-S18-W2-MC3	1"E, 3/4" R	25

W6 Series for 3/8" Plain or Threaded Rod **

78205123628	BP8-S18-W6	1/2" EMT	25
78205123629	BP12-S18-W6	3/4" E or 1/2" R	25
78205123630	BP16-S18-W6	1"E, 3/4" R	25

W6 Series for 3/8" Plain or Threaded Rod & Multiple Conduit Plate **

78205152850	BP8-S18-W6-MC3	1/2" EMT	25
78205152851	BP12-S18-W6-MC3	3/4" E or 1/2" R	25
78205152854	BP16-S18-W6-MC3	1"E, 3/4" R	25

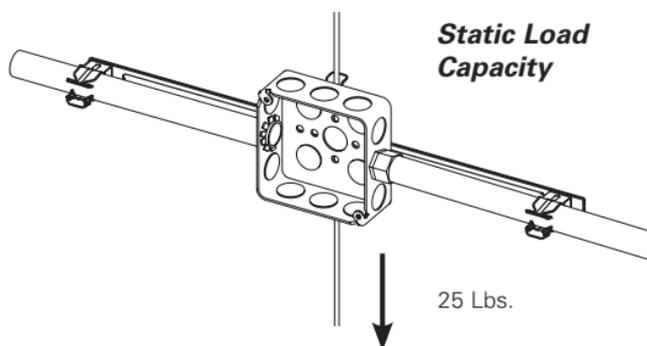

** Note:

An independent means of support is required by NEC Article 300.11.

Read safety/installation instruction sheets in packages before use.

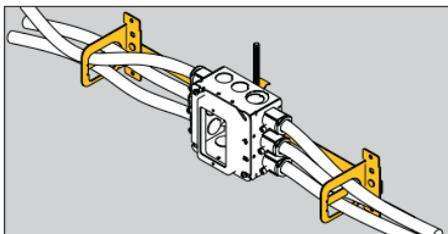

Multi-Run Cable Carrier & Box Support Fasteners



BRC5_S18

- Riveted assembly provides support for electrical boxes and cable runs on either side of the box.
- Reduces drop wires by up to 66% when using W2/W6 assemblies.
- Cable retention tab is open for easy loading and contains the cables when bent in place.
- Consult factory for pre-fab box assemblies.

UPC/Part Number	Catalog Number	Conduit Size	Box Qty.
78205152916	BRC51-S18	Up to 4 runs .430" - .560"	25
78205152918	BRC53-S18	Up to 7 runs .560" - .690"	25



BRC5_S18-S
With 1/4"-20 x 5/8" Stud

UPC/Part Number	Catalog Number	Conduit Size	Box Qty.
78205152919	BRC51-S18S	Up to 4 runs .430" - .560"	25
78205152921	BRC53-S18S	Up to 7 runs .560" - .690"	25

With Stud

Read safety/installation instruction sheets in packages before use.

Conduit & cable



BRC5_-S18-W_

UPC/Part Number	Catalog Number	Conduit Size	Box Qty.
W2 Series for #12 thru 1/4" Rod **			
78205152865	BRC51-S18-W2	Up to 4 runs .430" - .560"	25
78205152869	BRC53-S18-W2	Up to 7 runs .560" - .690"	25

UPC/Part Number	Catalog Number	Conduit Size	Box Qty.
W6 Series for 3/8" Plain or Threaded Rod **			
78205152866	BRC51-S18-W6	Up to 4 runs .430" - .560"	25
78205152870	BRC53-S18-W6	Up to 7 runs .560" - .690"	25

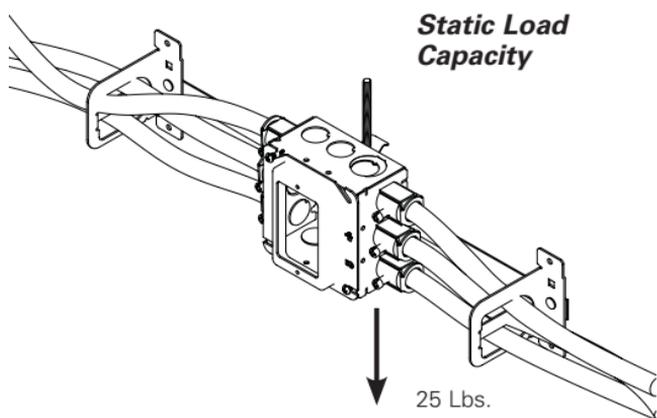

** Note:
An independent means of support is required by NEC Article 300.11.

Read safety/installation instruction sheets in packages before use.