

August 2007

200 Series Zero Pressure Accumulation System**Contents**

Overview	6-13
Model Selection, Basic Logic Sensors	6-15
Model Selection, Progressive Logic Sensors	6-15
Model Selection, Harnesses	6-15
Model Selection, Accessories	6-16
Wiring Diagram	6-18
Dimensions	6-19
Specifications, Models 14266 and 14286	6-19
Model Selection, Standard Sensors	6-20
Model Selection, Harnesses	6-20
Model Selection, Accessories	6-21
Wiring Diagram	6-22
Dimensions	6-22
Specifications, Model 14256	6-22
Wiring Diagrams	6-23

The Cutler-Hammer® 200 Series by Eaton's electrical business is an easy to use Zero Pressure Accumulation (ZPA) sensing and control solution. This sensor system solves the problem of product damage and mishandling caused by mechanical sensor rollers on outdated ZPA conveyors.

A Complete, Pre-engineered Solution

The 200 Series comes complete with all needed components including sensors, pre-measured cables, power supplies, and accessories. These components simply snap together to provide reliable Zero Pressure Accumulation conveyor control without the need to invest costly engineering time in a PLC-based system. The compact power supply, designed specifically for the 200 Series, includes an integral junction box to eliminate additional mounting enclosures.

For the most current information on this product, visit our web site: www.EatonElectrical.com

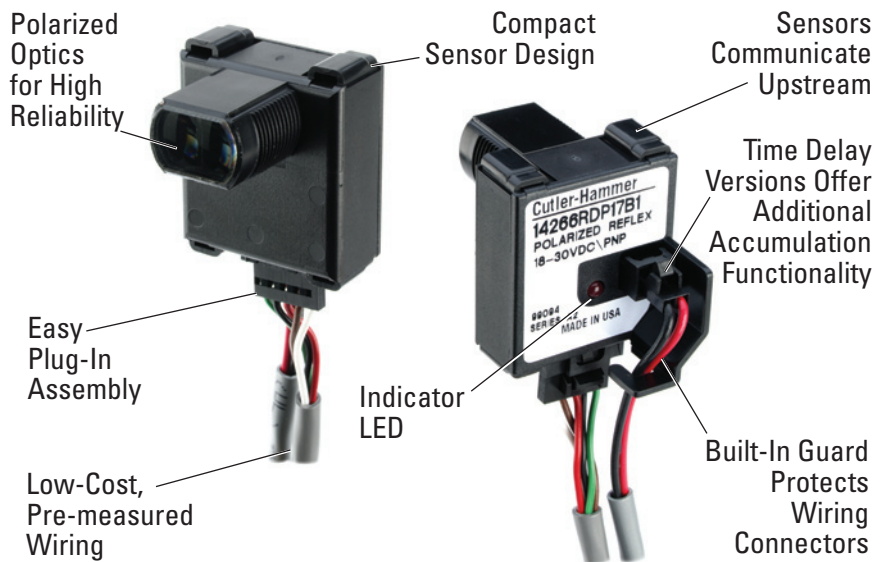
A Fully Engineered Non-contact, Photoelectric Sensor System with Built-In Accumulation Control**Product Features**

- Non-contact, true Zero Pressure Accumulation control without a PLC
- Multiple algorithms available to provide the exact functionality you require
- Additional Gap and Compression timing versions available
- Low installation costs with pre-measured and connectorized wiring
- Fits zone lengths between 18 and 60 inches in 6-inch increments and conveyors up to 60 inches wide
- Compatible with commonly available solenoid-operated air valves
- Sensors are short circuit protected with automatic reset of sensor when short is removed
- System designed with sub-4A 24V DC wiring for safety and reduced costs
- Easily interfaced to external control systems for singulated discharge and/or slug release
- Highly optimized, low-cost power supply
- Custom brackets and sensor/bracket assemblies available

Fast, Low Cost Installation and Retrofit

The unique 200 Series reduces installation costs by eliminating measuring, wire stripping and attachment of custom connectors. The main buss cable has connectors pre-installed at points to match your conveyor zone length. Zone length can be from 18 to 60 inches in 6-inch increments. Custom wiring harnesses are supplied for an exact fit-between the main buss cable, the

solenoid, and the sensor to eliminate unsightly cable loops that might otherwise be snagged and damaged.

High Reliability

200 Series sensors operate in the polarized reflex sensing mode. Polarized sensors eliminate detection errors caused by shiny targets. The sensor's 10 foot maximum range provides high sensing reliability when used at common conveyor widths.

For Customer Service in the U.S. call 1-877-ETN CARE (386-2273),
in Canada call 1-800-268-3578.
For Application Assistance in the U.S. and Canada
call 1-800-426-9184.

Choose a Sensor to Meet Your Specific Needs

To provide an ideal solution for a wide variety of zero-pressure accumulation needs, 200 Series sensors are available in two different embedded logic modes:

- The Basic Logic Series offers high-throughput smart Zero Pressure Accumulation control. This logic results in singulation and Zero Pressure Accumulation. Each sensor checks the status of the downstream zone and each zone always runs except when both the current and downstream zones are full. Models are available in either Zone Full Delay Timer or Zone Empty Timer configurations.
- The Progressive Logic Series offers even higher throughput than the Basic Logic. This logic does not singulate product, but does result in Zero Pressure Accumulation. Each zone always runs until all of the zones downstream are full, allowing maximum efficiency. Models are available in either Zone Full Delay Timer or Zone Empty Timer configurations.

It's So Easy to Get Started, All That's Needed Is:

- Your conveyor zone length(s)
- Preferred ZPA algorithm
- Sensor harness cable lengths:
 - Distance from sensor to power buss harness
 - Distance from sensor to solenoid
- Solenoid valve manufacturer and model number

200 Series System Components

Sensor

The 200 Series sensor has been specially designed with upstream communication abilities and internal logic to implement true zero pressure accumulation control. When combined with the components below, a complete ZPA conveyor control system can be literally snapped into place on your conveyor. Two versions are available depending upon the control you require: Basic Logic and Progressive Logic (described above).



Sensor with Additional Time Delay

These 200 Series sensors are the same as standard units in all respects, with the exception of additional time delay circuitry designed to afford you enhanced zero pressure accumulation control. Versions with a "Gap Timer" offer you an adjustable delay to insert additional gaps between adjacent products as they move down the conveyor (beyond those gaps normally present due to the operation of the built-in true zero pressure accumulation logic). Versions with a "Compression Timer" offer you an adjustable delay to compress packages together during the accumulation process.

Sensor Harness

The Sensor Harness connects the sensor to the Buss Harness and solenoid.^① This is the only custom part of the system — the length is optimized for an exact fit on your conveyor to eliminate cable loops that could otherwise be damaged.



Buss Harness

The Buss Harness distributes power, slug release signals and provides communications links. Made from flat ribbon cable, it is available in 10, 50 and 100 foot lengths and is connectorized at intervals to match your zone length (18 to 60 inches in 6-inch increments).



^① A customer-supplied solenoid/valve is required at each zone to control the conveyor pneumatics. Eaton recommends a solenoid below 1.8 Watts.

August 2007

Model Selection — Basic Logic Sensors

Photo	Logic	Type	Sensing Range	Optimum Range	Field of View	Additional Timing	Operate Mode	Output	Catalog Number/Standard
	Basic Logic	Polarized Reflex	10 feet (3m)	0.1 to 8 feet (0.03 – 3.6 m)	3 inch (76 mm) Diameter at 12 feet (3.6m)	—	Air to Drive	NPN	14266RLN17B1
								PNP	14266RLP17B1
							Air to Brake	NPN	14266RDN17B1
								PNP	14266RDP17B1
	Compression Timer						Air to Drive	NPN	14266RLNT17B1
								PNP	14266RLPT17B1
	Air to Brake						NPN	14266RDNT17B1	
							PNP	14266RDPT17B1	
Gap Timer ①	Air to Drive	PNP	14266RLPC17B1						
		Air to Brake ①	PNP	14266RDPC17B1					

① Models only available in PNP versions. To implement this timing functionality and retain access to slug release mode, all sensors in a given ZPA chain must be PNP output versions.

Model Selection — Progressive Logic Sensors



Photo	Logic	Type	Sensing Range	Optimum Range	Field of View	Additional Timing	Option	Output	Catalog Number/Standard
	Progressive Logic	Polarized Reflex	10 feet (3m)	0.1 to 8 feet (0.03 – 3.6 m)	3 inch (76 mm) Diameter at 12 feet (3.6m)	—	Air to Drive	NPN	14286RLN17B1
								PNP	14286RLP17B1
							Air to Brake	NPN	14286RDN17B1
								PNP	14286RDP17B1
	Compression Timer						Air to Drive	NPN	14286RLNT17B1
								PNP	14286RLPT17B1
	Air to Brake						PNP	14286RDPT17B1	
							Gap Timer	Air to Drive	PNP
Air to Brake	PNP	14286RDPC17B1							

Model Selection — Sensor Harnesses





Photo	Solenoid Connector ①	Sensor to Buss Harnesses Length	Sensor to Solenoid Length	Use with Sensor Models	Catalog Number
	3-pin AMP P/N 104257-2	12 inches	12 inches	14266.../14286...	QD266A12-1201B1
	3-pin SMC P/N AXT661-12A				QD266A12-1204B1
		24 inches	24 inches		QD266A24-2404B1
		36 inches	36 inches		QD266A36-3604B1

① If you require a solenoid connector other than those listed in this section, contact Eaton's Cutler-Hammer Sensor Applications Department at 1-800-426-9184 with the valve manufacturer's name and model number.

Model Selection — Buss Harnesses

Photo	Zone Length	Nominal Length	Number of Zones	Use with Sensor Models	Catalog Number
 <p>50' and 100' Versions</p>	18 inches	10 feet (1.8m)	6 Zones	14266.../14286...	BUS266A18-6
		50 feet (3.6m)	33 Zones		BUS266A18-33
		100 feet (6.1m)	66 Zones		BUS266A18-66
	24 inches	10 feet (1.8m)	5 Zones		BUS266A24-5
		50 feet (3.6m)	25 Zones		BUS266A24-25
		100 feet (6.1m)	50 Zones		BUS266A24-50
	30 inches	10 feet (1.8m)	4 Zones		BUS266A30-4
		50 feet (3.6m)	20 Zones		BUS266A30-20
		100 feet (6.1m)	40 Zones		BUS266A30-40
36 inches	10 feet (1.8m)	3 Zones	BUS266A36-3		
	50 feet (3.6m)	16 Zones	BUS266A36-16		
	100 feet (6.1m)	33 Zones	BUS266A36-33		
40 inches	10 feet (1.8m)	3 Zones	BUS266A40-3		
	50 feet (3.6m)	15 Zones	BUS266A40-15		
	100 feet (6.1m)	30 Zones	BUS266A40-30		
42 inches	10 feet (1.8m)	2 Zones	BUS266A42-2		
	50 feet (3.6m)	14 Zones	BUS266A42-14		
	100 feet (6.1m)	28 Zones	BUS266A42-28		
48 inches	10 feet (1.8m)	2 Zones	BUS266A48-2		
	50 feet (3.6m)	12 Zones	BUS266A48-12		
	100 feet (6.1m)	25 Zones	BUS266A48-25		
54 inches	10 feet (1.8m)	2 Zones	BUS266A54-2		
	50 feet (3.6m)	11 Zones	BUS266A54-11		
	100 feet (6.1m)	22 Zones	BUS266A54-22		
60 inches	10 feet (1.8m)	2 Zones	BUS266A60-10		
	50 feet (3.6m)	10 Zones	BUS266A60-2		
	100 feet (6.1m)	20 Zones	BUS266A60-20		
 <p>10' Versions</p>					



Model Selection — Accessories

Photo	Type	Description	Length	Notes	Catalog Number
	Singulate Release Cable	This cable is connected to the last zone and allows singulate or slug discharge control from an external system.	2m	Release only	BUS266REL-01B1
				Both release and power connections are provided. If the power connection is used, a power supply cable is not needed	BUS266REL-02B1
	Zone Jumper	A Zone Jumper is required when a zone is skipped to allow communications to continue through the unused zone.	5 inches	—	QDJU266A-01B1
	Power Supply	A 100W Power Supply designed for use with the 200 Series system. On systems with zone lengths up to 48 inches, it will power up to 110 sensors with 0.67W solenoids (74 if the solenoids are 1.2W; 38 if the solenoids are 2.4W).	—	—	PS256A-01B1 PS256A-04B1 (See Page 6-27 for more details)
	Power Supply Cable	This cable allows the power supply to be connected to any zone, while allowing use of that zone. For best results, the Power Supply Cable should be connected at the center of the zones being powered.	2m	—	BUS266PWR-01B1
			50 feet	—	BUS266PWR-5001B1

■ Stocked product, typical order quantities guaranteed in stock.

August 2007

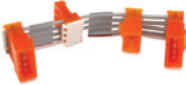
Model Selection — Accessories (Continued)

Photo	Type	Description	Length	Notes	Catalog Number
	Buss Link Cable	This cable allows two sections of buss harness to be connected together. NOTE: 10 foot versions of buss harness have this connector built-in.	10 cm	Passes power and ZPA signals	BUS266LINK-01B1
			10 cm	Power isolation version. Passes ZPA signals but isolates power. This allows for connection of more than one power supply to a long section of ZPA conveyor.	BUS266ISO-01B1
		This cable allows two sections of buss harness to be connected together. DC power is passed through the connection.	3m	Passes power only	BUS266JUMP15-01B1
		This cable allows two sections of buss harness to be connected together. Both DC power and the ZPA signal is passed through the connection.	3m	Passes power and ZPA signals	BUS266JUMP15-02B1
	Power Curve Module	Allows ZPA through a powered curve that is not divided into ZPA controlled zones. All required wiring is included.	—	Install adjacent to the 200 Series sensor at the powered curve infeed. All required wiring included.	1451BSR1216

CONVEYOR SENSOR SYSTEMS

6

Typical Wiring Example — Nominal 10' Buss Harness Lengths

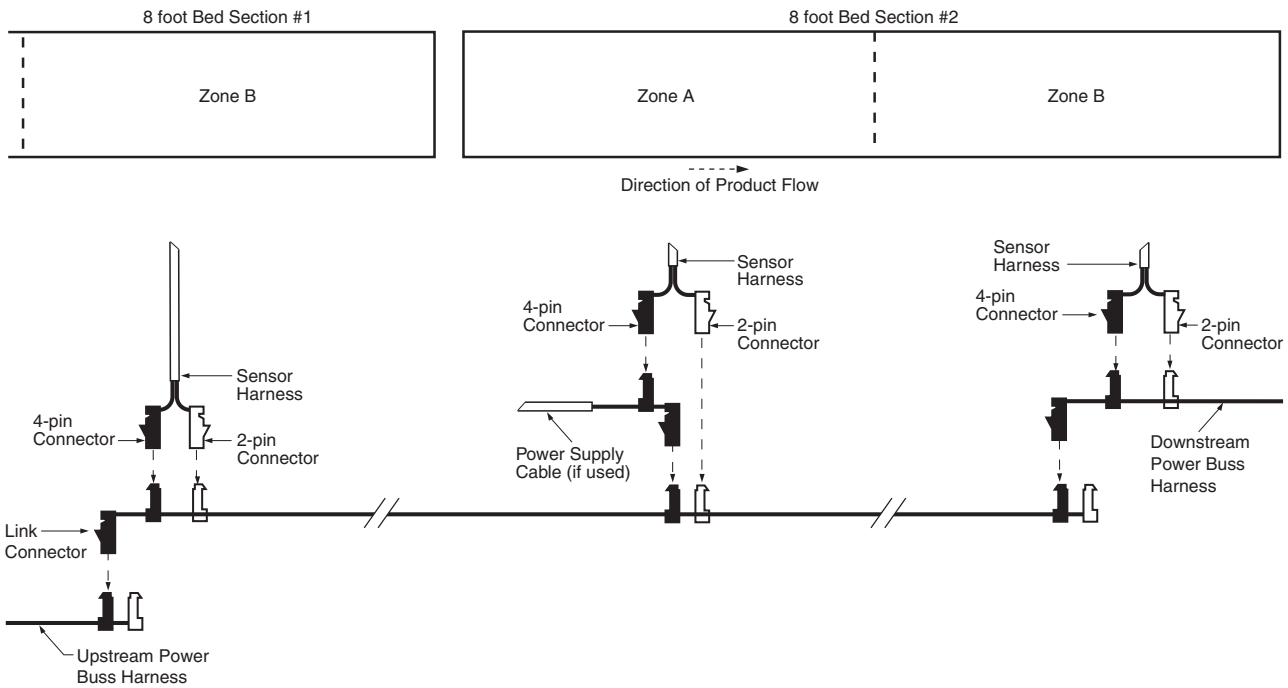

Example shows Power Buss Harness (BUS266A48-2) mounted to a conveyor with 4' zones/8' bed sections

Wiring Diagram

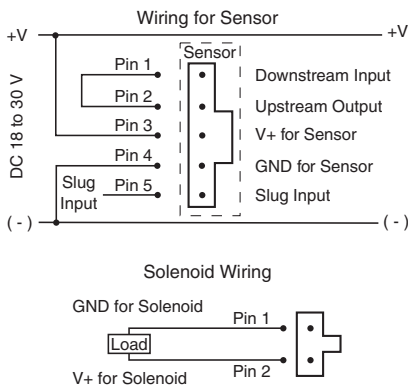

Optical Performance

All optical specifications are guaranteed to be the minimum performance under clean conditions of any product delivered from stock. Typical performance may be higher.

Dirt in the environment will affect optical performance by reducing the amount of light the control receives. For best results, sensors should be used at distances where excess gain is higher than 1.5 (1.5 times the amount of sensing power required to detect an object under ideal conditions). Higher excess gain will allow the sensor to overcome higher levels of contamination on the lens. All ranges and excess gain graphs are based on a 3-inch retroreflector.

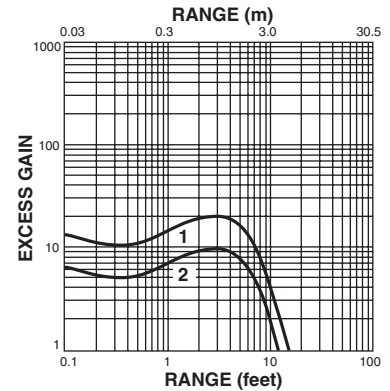

- 1. Typical performance ①
- 2. Minimum performance ①
- ① Performance measured to 3-inch retroreflector.

Source	Visible red, 680 nm
Maximum Range	10 feet
Optimum Range	0.1 to 8 feet
Field of View	3 inch diameter at 12 feet

August 2007

Typical Wiring Example — Nominal 50' and 100' Buss Harness Lengths

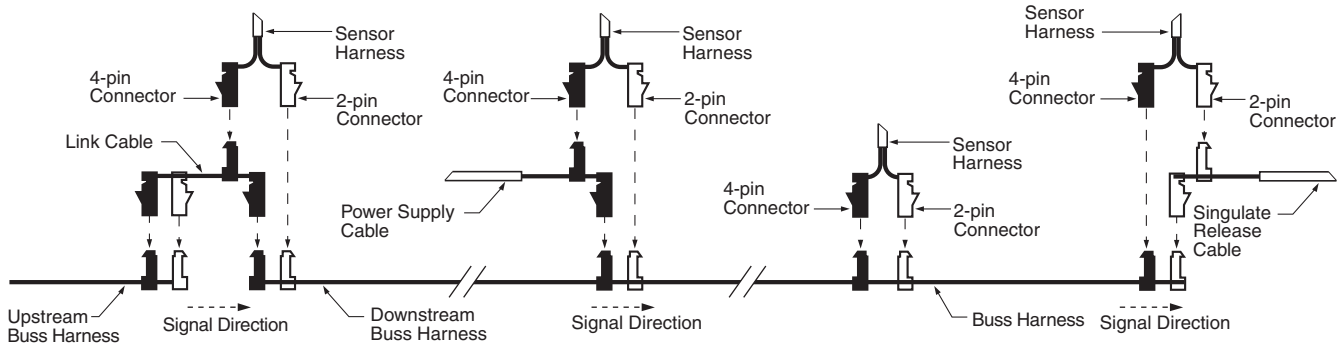

Approximate Dimensions in Inches (mm) Except Where Noted

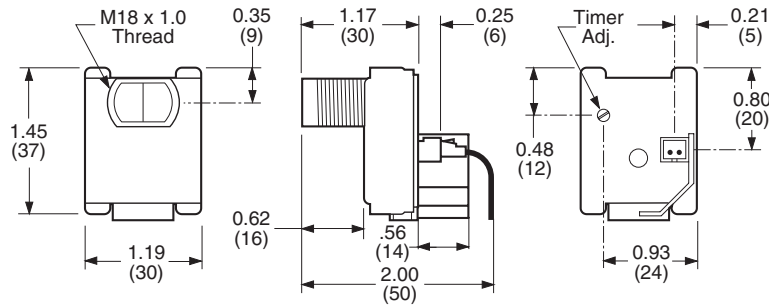

Specifications — 14266 and 14286 Models

Description	Specification
Input Voltage	18 to 30V DC, reverse polarity protected
Power Dissipation	250 mW maximum
Output Type	NPN or PNP
Current Switching Capacity	100 mA maximum
OFF-State Leakage	10 mA maximum
ON-State Voltage Drop	2.5V at 100 mA
Slug Input	NPN: Integral diode isolates slug input; Input is protected against mis-wiring and is active from "0" to a voltage level equal to the current "input voltage" minus 6 volts PNP: Integral diode isolates slug input; Input is protected against mis-wiring and is active from 1 – 30V DC
Response Time	8 mS
Connector	5-pin, works with mating plug AMP #104257-4; 2-pin, works with mating plug AMP #104257-1
Temperature Range	Operating: -25° to 55°C (-13° to 131°F) Storage: -25° to 70°C (-13° to 158°F)
Material of Construction	Lens: Polycarbonate Body: Cyclopol and Lexan Connector: Glass-filled PCT
Vibration and Shock	Vibration: 30 g over 10 Hz to 2 kHz Shock: 30 g for 10 mS 1/2 sinewave pulse
Enclosure Ratings	NEMA 1
Cable-Pull Strength	20 pounds (static)
Approvals	Contact factory for latest list of agency approvals
Short-Circuit Protection	The Output is protected against dead shorts only. Operation: Output is continuously retried at 3 mS intervals and will automatically reset when short is removed (no visual indication of a short-circuit condition). CAUTION: will not protect against overloads between 100 – 300 mA
Indicator LED	Lights steady when output is ON; OFF when output is OFF; OFF when output is in short-circuit mode

The standard sensors in this section are similar to the embedded logic sensors in the previous sections except that the units do not contain on-board ZPA logic, the sensors directly actuate the solenoid valves to which they are connected.

Model Selection — Standard Sensors

Photo	Type	Sensing Range	Optimum Range	Field of View	Connection Type	Operate Mode	Output	Catalog Number/Standard
	Polarized Reflex	10 feet (3m)	0.1 to 8 feet (0.03 – 3.6 m)	3 inch (76 mm) Diameter at 12 feet (3.6m)	Multi-Drop	Air to Drive	NPN	14256RLN17B1
							PNP	14256RLP17B1
						Air to Brake	NPN	14256RDN17B1
							PNP	14256RDP17B1
	Air to Drive	Dual NPN & PNP	14256RL17B1					
	Air to Brake		14256RD17B1					

Fast turn product with typical one business day lead-time to shipment.

Model Selection — Sensor Harnesses

Photo	Solenoid Connector ^①	Sensor to Buss Harnesses Length	Sensor to Solenoid Length	Use with Sensor Models	Catalog Number
	3-pin AMP P/N 104257-2	12 inches	12 inches	14256...	QD256A12-1201B1
	3-pin SMC P/N AXT661-12A				QD256A12-1204B1







^① If you require a solenoid connector other than those listed in this section, contact Eaton's Cutler-Hammer Sensor Applications Department at 1-800-426-9184 with the valve manufacturer's name and model number.

Model Selection — Buss Harnesses

Photo	Zone Length	Nominal Length	Number of Zones	Use with Sensor Models	Catalog Number
	18 inches	50 feet (3.6m)	33 Zone	14266.../14286...	BUS256A18-33
		100 feet (6.1m)	66 Zone		BUS256A18-66
	24 inches	50 feet (3.6m)	25 Zone		BUS256A24-25
		100 feet (6.1m)	50 Zone		BUS256A24-50
	30 inches	50 feet (3.6m)	20 Zone		BUS256A30-20
		100 feet (6.1m)	40 Zone		BUS256A30-40
	36 inches	50 feet (3.6m)	16 Zone		BUS256A36-16
		100 feet (6.1m)	33 Zone		BUS256A36-33
	40 inches	50 feet (3.6m)	15 Zone		BUS256A40-15
		100 feet (6.1m)	30 Zone		BUS256A40-30
	42 inches	50 feet (3.6m)	14 Zone		BUS256A42-14
		100 feet (6.1m)	28 Zone		BUS256A42-28
	48 inches	50 feet (3.6m)	12 Zone		BUS256A48-12
		100 feet (6.1m)	25 Zone		BUS256A48-25
	54 inches	50 feet (3.6m)	11 Zone		BUS256A54-11
		100 feet (6.1m)	22 Zone		BUS256A54-22
60 inches	50 feet (3.6m)	10 Zone	BUS256A60-10		
	100 feet (6.1m)	20 Zone	BUS256A60-20		

August 2007

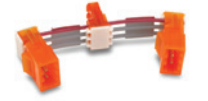
Model Selection — Accessories

Photo	Type	Description	Length	Notes	Model Number
	Power Supply	A 100W Power Supply designed for use with the 200 Series system. On systems with zone lengths up to 48 inches, it will power up to 110 sensors with 0.67W solenoids (74 if the solenoids are 1.2W; 38 if the solenoids are 2.4W).	—	—	PS256A-01B1 PS256A-04B1 (See Page 6-27 for more details)
	Power Supply Cable	This cable allows the power supply to be connected to any zone, while allowing use of that zone. For best results, the Power Supply Cable should be connected at the center of the zones being powered.	2m	Round cable	BUS256PWR-01B1
			6.7m	Round cable, 18 AWG conductors	BUS256PWR20-02B1
			3.3m	Flat ribbon cable	BUS256PWR120
	Buss Link Cable	This cable allows two sections of buss harness to be connected together.	10 cm	Passes power only	BUS256LINK-01B1
			10 cm	Power isolation version. Passes ZPA signals but isolates power. This allows for connection of more than one power supply to a long section of ZPA conveyor.	BUS256ISO-01B1
			54 inches	Flat ribbon cable — Passes power only	BUSJUMP36

 Stocked product, typical order quantities guaranteed in stock.

Typical Wiring Example

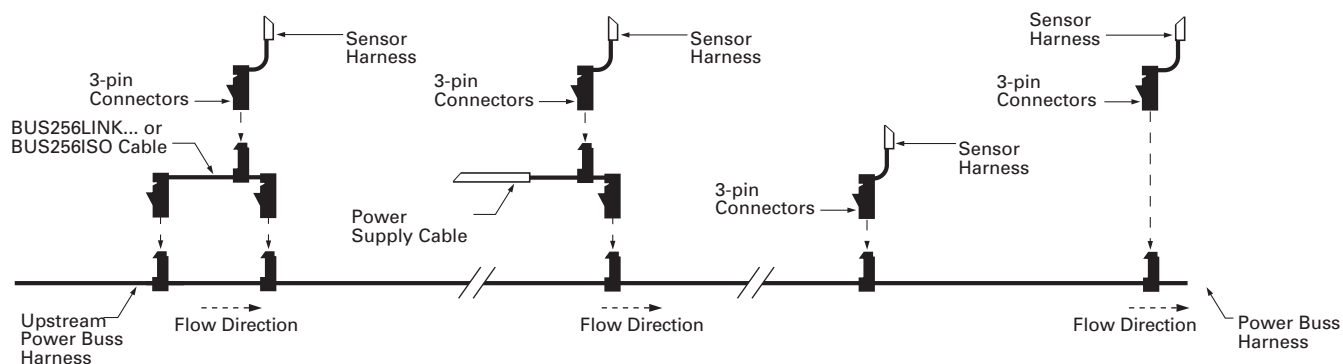

Approximate Dimensions in Inches (mm) except where noted

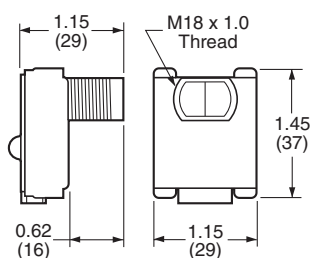

Specifications — 14256 Models

Description	Specification
Input Voltage	10 to 30V DC, reverse polarity protected
Power Dissipation	120 mW maximum
Output Type	NPN only or NPN & PNP Dual Output
Output Operation – Air to Brake	ON when beam is blocked OFF when beam is not blocked
Output Operation – Air to Drive	ON when beam is not blocked OFF when beam is blocked
Current Switching Capacity	100 mA maximum
OFF-State Leakage	10 mA maximum
ON-State Voltage Drop	2.5V at 100 mA
Slug Input	Integral diode isolates slug input; Input is protected against mis-wiring and is active from "0" to a voltage level equal to the current "input voltage" minus 6 volts
Response Time	8 mS
Connector	Works with mating plug; AMP #104257-4
Temperature Range	Operating: -25° to 55°C (-13° to 131°F) Storage: -25° to 70°C (-13° to 158°F)
Material of Construction	Lens: Polycarbonate Body: Cyclopol and Lexan Connector: Glass-filled PCT
Vibration and Shock	Vibration: 30 g over 10 Hz to 2 kHz Shock: 30 g for 10 mS 1/2 sinewave pulse
Enclosure Ratings	NEMA 1
Cable-Pull Strength	20 pounds (static)
Approvals	Contact factory for latest list of agency approvals
Short-Circuit Protection	The Output is protected against dead shorts on the NPN output only. Operation: Output is continuously retried at 3 mS intervals and will automatically reset when short is removed (no visual indication of a short-circuit condition). CAUTION: will not protect against overloads between 100 – 300 mA
Indicator LED	Lights steady when output is ON; OFF when output is OFF; OFF when output is in short-circuit mode

August 2007

Wiring Diagrams

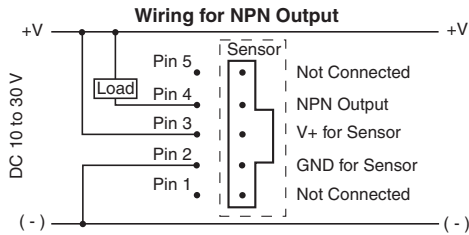
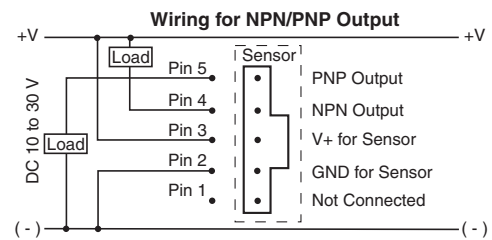
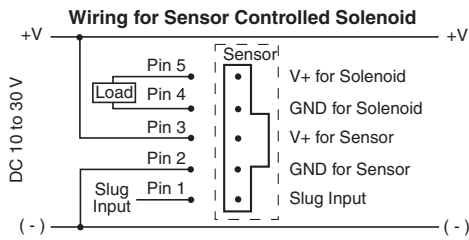

Optical Performance

All optical specifications are guaranteed to be the minimum performance under clean conditions of any product delivered from stock. Typical performance may be higher.

Dirt in the environment will affect optical performance by reducing the amount of light the control receives. For best results, sensors should be used at distances where excess gain is higher than 1.5 (1.5 times the amount of sensing power required to detect an object under ideal conditions). Higher excess gain will allow the sensor to overcome higher levels of contamination on the lens. All ranges and excess gain graphs are based on a 3-inch retroreflector.

Source	Visible red, 680 nm
Maximum Range	10 feet
Optimum Range	0.1 to 8 feet
Field of View	3 inch diameter at 12 feet

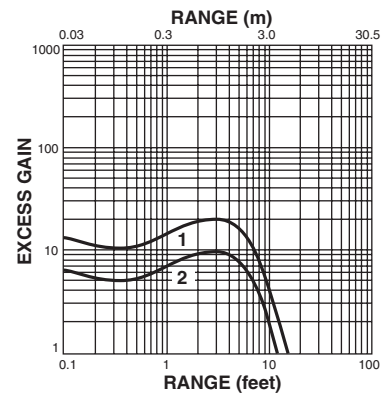

- 1. Typical performance^①
- 2. Minimum performance^①
- ^① Performance measured to 3-inch retroreflector.