

30.5 mm Heavy-Duty Watertight/Oiltight—10250T



Contents

| <i>Description</i> | <i>Page</i> |
|---|-------------|
| 30.5 mm Heavy-Duty Watertight/Oiltight—10250T | |
| Product Overview | V7-T1-214 |
| Product Identification | V7-T1-214 |
| Catalog Number Selection | V7-T1-215 |
| Product Selection | |
| Point-of-Purchase Packaging | V7-T1-217 |
| Non-Illuminated Momentary Pushbutton Units | V7-T1-218 |
| Pushbuttons | V7-T1-219 |
| Illuminated Momentary Pushbutton Units | V7-T1-222 |
| Indicating Light Units | V7-T1-223 |
| Illuminated Pushbuttons and Indicating Lights | V7-T1-224 |
| Push-Pull Emergency Stop | V7-T1-226 |
| Illuminated Push-Pull Units | V7-T1-229 |
| Potentiometers | V7-T1-232 |
| Push-Pull Operators | V7-T1-233 |
| Selector Switch Units | V7-T1-237 |
| Selector Switch Selection | V7-T1-238 |
| Selector Switch Operators | V7-T1-241 |
| Illuminated Selector Switch Operators | V7-T1-244 |
| Joystick Units | V7-T1-245 |
| Joysticks | V7-T1-246 |
| Roto-Push Units | V7-T1-249 |
| Roto-Push Operators | V7-T1-250 |
| Accessories | V7-T1-255 |
| Options | V7-T1-260 |
| Replacement Parts | V7-T1-269 |
| Technical Data and Specifications | V7-T1-271 |
| Dimensions | V7-T1-274 |



Application Description

Contact Operation

Slow make and break. All normally closed contacts have positive opening operation, i.e., normally closed contacts are forced open in the event of contact weld or spring breakage.

Standards and Certifications

- CE EN 60947-5-1 and 60947-5-5
- UL 508—File No. 131568
- CSA C22.2 No. 14—File No. LR68551



Ingress Protection

When mounted in similarly rated enclosure—

- Standard indicating lights
 - UL (NEMA) Type 1, 2, 3, 3R, 3S, 4, 4X, 12, 13
 - IEC IP65
- Most other operators
 - UL (NEMA) Type 1, 2, 3, 3R, 4, 4X, 12, 13
 - IEC IP65

Product Description

The 30.5 mm pushbutton line features a zinc die cast construction with chrome-plated housing and mounting nut. The same durable construction is also available with the corrosive resistant E34 line of pushbuttons. See E34 section on **Pages V7-T1-284 to V7-T1-325**.

Features

- Heavy-duty zinc die cast construction
- Enclosed silver contacts with reliability nibs
- Diaphragm seals with drainage holes
- Grounding nibs on the operator casing

Benefits

- Reliability nibs improve contact reliability even under dry circuit and fine dust conditions
- Drainage holes prevent buildup of liquid inside the operator which can prevent operation in freezing environments
- Grounding nibs bit through paint and other coatings to provide secure ground

1

Product Overview

Reliability Nibs

Eaton's contact blocks feature enclosed silver contacts with pointed "reliability nibs" for reliable performance from logic level up to 600V. To ensure reliable switching, nibs bite through oxide which can form on silver contacts, eliminating the need for expensive logic level blocks for most applications.

Reliability Nibs

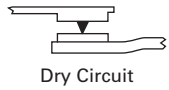

Dry Circuit

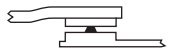

Medium Duty

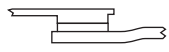

Heavy-Duty

Reliability nibs improve performance in dry circuit, corrosive, fine dust and other contaminated atmospheres. Under normal environmental conditions, the minimum operational voltage is 5V and the minimum operational current is 1 mA, AC/DC. For operation under a wider range of environmental conditions, logic level contact blocks with inert palladium tipped contacts are recommended.

Grounding Nibs

10250T line operators have "grounding nibs"—four metal points on the operator casting designed to bite through most paints and other coatings on metal panels to enhance the ground connection when the operator is securely tightened.

Grounding Nibs

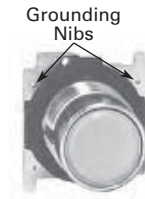

Diaphragm Seal with Drainage Holes

Liquid Drainage

Eaton's pushbutton operators offer front of panel drainage via holes in the operator bushing. Hidden from view by the mounting nut, these holes prevent buildup of liquid inside the operator, which can prevent operation in freezing environments. The holes also provide a route for escaping liquid in high pressure washdowns, effectively relieving pressure from the internal diaphragm seal, ensuring reliable sealing in applications even beyond NEMA 4.

Diaphragm Seal

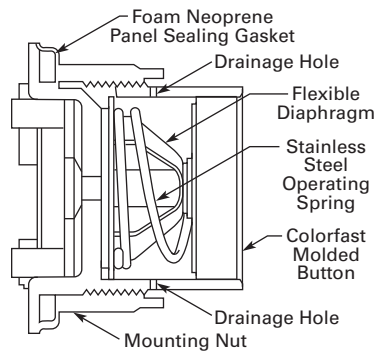

Product Identification

30.5 mm Heavy-Duty Watertight/Oiltight—10250T Series

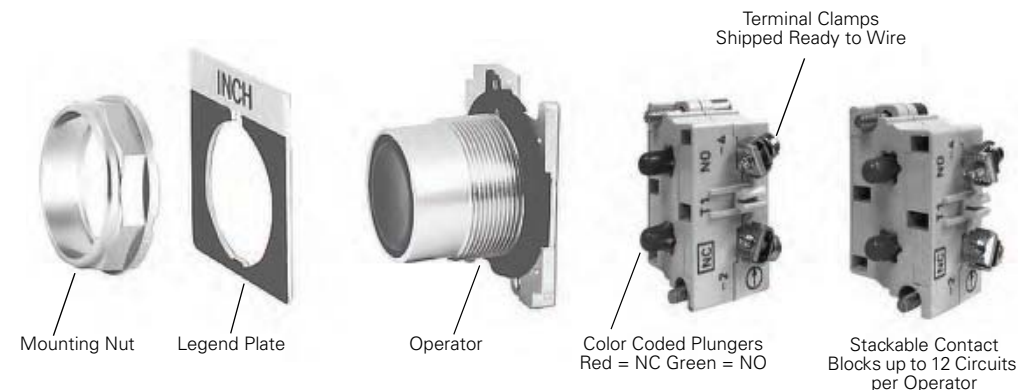

Catalog Number Selection

Catalog Number Selection is for illustrative purposes only and not to be used to create new catalog numbers.

Non-Illuminated Pushbuttons

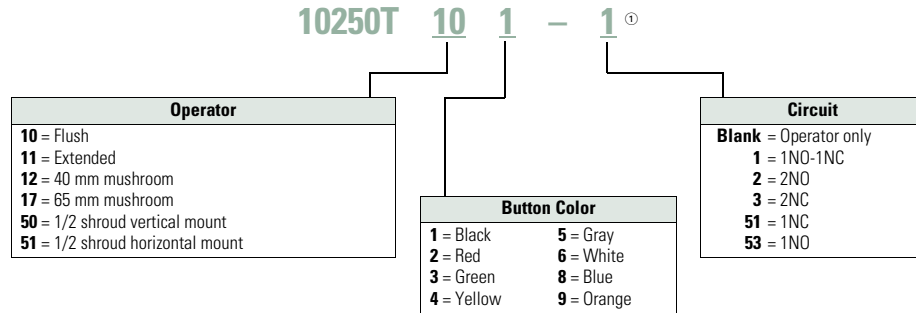

Illuminated and Non-Illuminated Push-Pulls

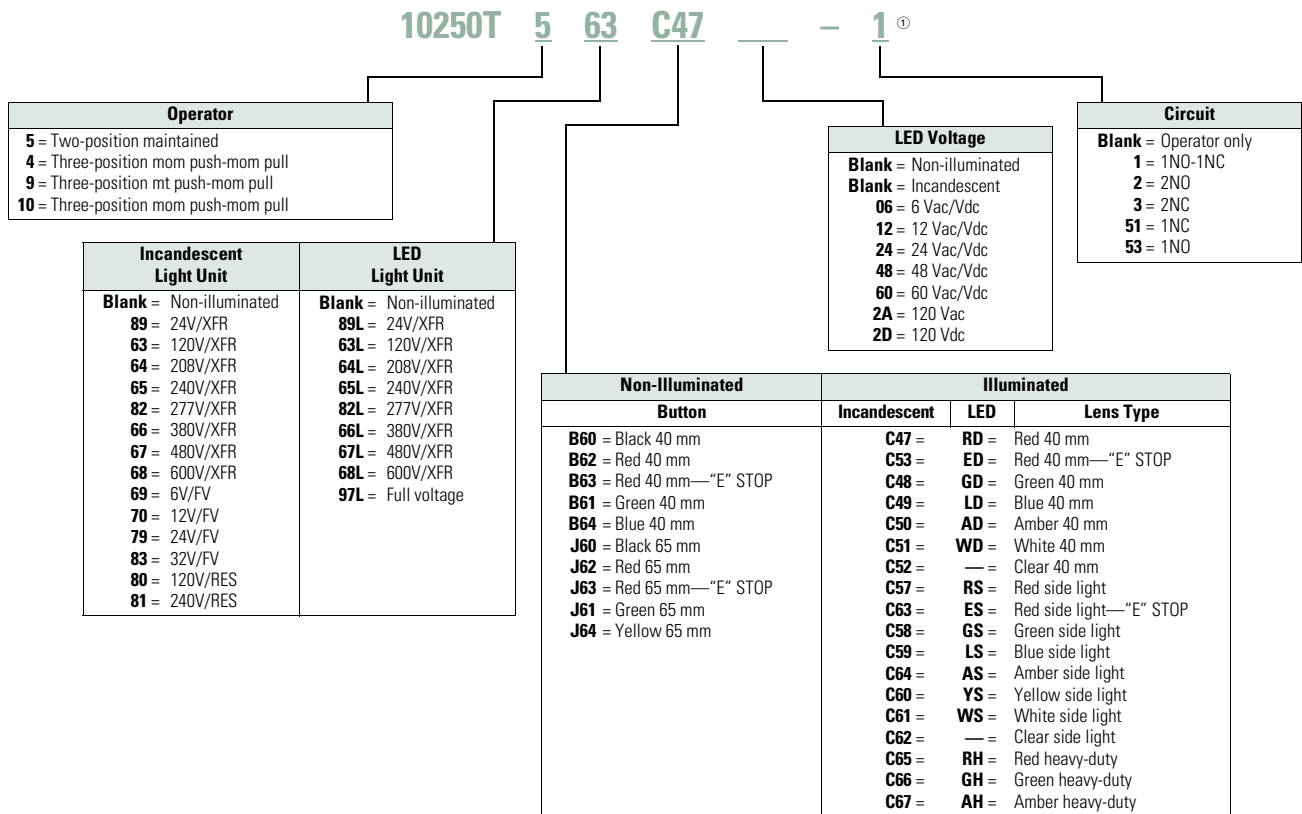

Note

① Add **X** at end of catalog number to receive parts assembled from factory.

Product Selection

Point-of-Purchase Packaging

Point-of-Purchase Packaged Pilot Device



10250T Point-of-Purchase Packaged Pilot Devices

| Product | Description | Catalog Number |
|---|---|---------------------------|
| Emergency Stop Operators | | |
| Red non-illuminated push-pull | 1NO-1NC contact block. Also includes two square engraved legend plates: EMERG. STOP and STOP. | 10250T5B62-1-POP |
| Red mushroom pushbutton | 1NO-1NC contact block. Also includes two square engraved legend plates: EMERG. STOP and STOP. | 10250T32R-POP |
| Red jumbo mushroom pushbutton | Engraved EMERG. STOP with 1NO-1NC contact block. | 10250T33-POP |
| Momentary Pushbuttons | | |
| Black flush pushbutton | 1NO-1NC contact block. Also includes two square engraved legend plates: START and JOG. | 10250T30B-POP |
| Green flush pushbutton | | 10250T30G-POP |
| Red extended pushbutton | 1NO-1NC contact block. Also includes one square engraved legend plate: STOP. | 10250T31R-POP |
| Indicating Lights | | |
| Red indicating light | Full voltage 24 Vac/Vdc with two extra lenses: Green and amber. Also includes two square engraved legend plates: RUN and JOG. | 10250T206NC1N-POP |
| Red indicating light | Resistor 120 Vac/Vdc with two extra lenses: Green and Amber. Also includes one square engraved legend plate: RUN and JOG. | 10250T34R-POP |
| Illuminated Pushbuttons | | |
| Red illuminating pushbutton | Full voltage 24 Vac/Vdc with 1NO-1NC contact block and two extra lenses: Green and amber. Also includes one square engraved legend plate: POWER ON. | 10250T476C21-1-POP |
| Red illuminating pushbutton | Resistor 120 Vac/Vdc with 1NO-1NC contact block and two extra lenses: Green and amber. Also includes one square engraved legend plate: POWER ON. | 10250T411C21-1-POP |
| Selector Switches | | |
| Black knob two-position selector switch | 1NO-1NC contact block. Also includes three square engraved legend plates: OFF/ON, HAND/AUTO and RUN/JOG. | 10250T20KB-POP |
| Black knob three-position selector switch | 2NO-2NC contact blocks. Also includes 1 square engraved legend plate: HAND/OFF/AUTO. | 10250T22KB-POP |
| Black knob three-position selector switch | 1NO-1NC contact block. Also includes legend plate: HAND/OFF/AUTO | 10250T21KB-POP |

1

Non-Illuminated Momentary Pushbutton Units

UL (NEMA) Type 3, 3R, 4, 4X, 12, 13

Flush Button



Extended Button



Mushroom Button



Jumbo Mushroom



Pushbutton Units—Flush, Extended, Mushroom Head or Jumbo Mushroom Head Operators

| Contact Type | Button Color | Flush Button Catalog Number | Extended Button Catalog Number | Mushroom Button Catalog Number | Jumbo Mushroom ^① Catalog Number |
|--------------|--------------------------|-----------------------------|--------------------------------|--------------------------------|--|
| 1NO | Black | 10250T23B | 10250T25B | 10250T26B | 10250T27B |
| | Red | 10250T23R | 10250T112-53 | 10250T122-53 | 10250T172-53 |
| | Green | 10250T23G | 10250T25G | 10250T26G | 10250T27G |
| | Yellow | 10250T23Y | 10250T25Y | 10250T26Y | 10250T27Y |
| | Red—Engraved EMERG. STOP | — | — | — | 10250T17213-53 |
| 1NC | Black | 10250T101-51 | 10250T111-51 | 10250T121-51 | 10250T171-51 |
| | Red | 10250T102-51 | 10250T25R | 10250T26R | 10250T27R |
| | Green | 10250T103-51 | 10250T113-51 | 10250T123-51 | 10250T173-51 |
| | Yellow | 10250T104-51 | 10250T120-51 | 10250T124-51 | 10250T174-51 |
| | Red—Engraved EMERG. STOP | — | — | — | 10250T29 |
| 1NO-1NC | Black | 10250T30B | 10250T31B | 10250T32B | 10250T33B |
| | Red | 10250T30R | 10250T31R | 10250T32R | 10250T33R |
| | Green | 10250T30G | 10250T31G | 10250T32G | 10250T33G |
| | Yellow | 10250T30Y | 10250T31Y | 10250T32Y | 10250T33Y |
| | Red—Engraved EMERG. STOP | — | — | — | 10250T33 |
| 2NO | Black | 10250T101-2 | 10250T111-2 | 10250T121-2 | 10250T171-2 |
| | Red | 10250T102-2 | 10250T112-2 | 10250T122-2 | 10250T172-2 |
| | Green | 10250T103-2 | 10250T113-2 | 10250T123-2 | 10250T173-2 |
| | Yellow | 10250T104-2 | 10250T120-2 | 10250T124-2 | 10250T174-2 |
| | Red—Engraved EMERG. STOP | — | — | — | 10250T17213-2 |
| 2NC | Black | 10250T101-3 | 10250T111-3 | 10250T121-3 | 10250T171-3 |
| | Red | 10250T102-3 | 10250T112-3 | 10250T122-3 | 10250T172-3 |
| | Green | 10250T103-3 | 10250T113-3 | 10250T123-3 | 10250T173-3 |
| | Yellow | 10250T104-3 | 10250T120-3 | 10250T124-3 | 10250T174-3 |
| | Red—Engraved EMERG. STOP | — | — | — | 10250T17213-3 |







Note

① Anodized aluminum head is not suitable for use in ultraviolet light applications.

Pushbuttons

UL (NEMA) Type 3, 3R, 4, 4X, 12, 13

Momentary Pushbutton Operators, Non-illuminated

| Button | Color | Catalog Number | | |
|--|---|----------------------|----------------------|------------------|
| | | Vertical | Horizontal | |
| 10250T10_  | Flush button ① | Black | 10250T101 | |
| | Red | 10250T102 | | |
| | Green | 10250T103 | | |
| | Yellow | 10250T104 | | |
| | Gray | 10250T105 | | |
| | White | 10250T106 | | |
| | Blue | 10250T108 | | |
| | Orange | 10250T109 | | |
| | 10250T11_  | Extended button | Black | 10250T111 |
| Red | | 10250T112 | | |
| Green | | 10250T113 | | |
| Yellow | | 10250T120 | | |
| White | | 10250T116 | | |
| Blue | | 10250T118 | | |
| Orange | | 10250T119 | | |
| 10250T5_  | | Half shrouded button | Black | 10250T501 |
| | | Red | 10250T502 | 10250T511 |
| | Green | 10250T503 | 10250T512 | |
| | Yellow | 10250T504 | 10250T513 | |
| | Gray | 10250T505 | 10250T514 | |
| | White | 10250T506 | 10250T515 | |
| | Blue | 10250T508 | 10250T516 | |
| | Orange | 10250T509 | 10250T518 | |
| | 10250T12_  | Mushroom button | Black | 10250T121 |
| Red | | 10250T122 | | |
| Green | | 10250T123 | | |
| Yellow | | 10250T124 | | |
| Blue | | 10250T129 | | |
| 10250T17_  | Jumbo mushroom button ② | Black | 10250T171 | |
| | Red | 10250T172 | | |
| | Red (EMERG. STOP) | 10250T17213 | | |
| | Green | 10250T173 | | |
| | Yellow | 10250T174 | | |
| 10250ED1164_  | Low operating force—jumbo mushroom ②③ | Black | 10250ED1164-2 | |
| | Red | 10250ED1164-3 | | |
| | Green | 10250ED1164-4 | | |
| | Yellow | 10250ED1164-5 | | |
| | Clear | 10250ED1164 | | |

Note: To order complete assembled unit using one composite catalog number, add contact block and legend plate suffix to the end of operator catalog number. Example: 10250T101-1TS33



Operator
10250T101

+



Contact Block
10250T1

+



Legend Plate
10250TS33

Notes

- ① To order operator with factory assembled extended retaining nut, **10250TA12**, for thick panel applications, add suffix letter **E** to listed catalog number. Example: 10250T101**E**.
- ② Anodized aluminum head is not suitable for use in ultraviolet light applications.
- ③ Operating force—Standard = 2.4 lb; low force = 1.6 lb.

1

UL (NEMA) Type 3, 3R, 4, 4X, 12, 13

10250TA_

Mechanically Interlocked Pushbutton Operators



| Description | Catalog Number |
|---|----------------|
| Black flush and green flush | 10250TA66 |
| Black flush and long red | 10250TA67 |
| Black flush and red mushroom head | 10250TA68 |
| Black flush and lock-down red mushroom head | 10250TA69 ① |
| Black flush and red jumbo mushroom head | 10250TA76 |
| Green flush and long red | 10250TA72 |
| Black long and long red | 10250TA73 |
| Green flush and red mushroom head | 10250TA77 |
| Green flush and black flush | 10250TA75 |

Lockout Pushbutton Operators with Padlock Attachments

UL (NEMA) Type 3, 3R, 4, 4X, 12, 13

The following pushbutton and mushroom operators include an integral padlock attachment for applications requiring lockout/tagout of specific machine functions. They are available in styles which allow locking of a button in the down position

(stopped position) or locking a button in the up position (to prevent starting). Select the “Hand” latch type which functions as a momentary pushbutton until the operator presses the button and moves the padlock attachment into position for

locking, or choose the “Spring Loaded” latch type where the padlock attachment springs into place when the button is pressed. Units accept a customer supplied 1/4 in padlock.

10250TA16

Padlockable in the Down Position ②



| Operator Type | Color | Latch Type | Catalog Number |
|---------------|-------------------|---------------|----------------|
| Flush head | Red | Hand | 10250TA16 |
| Mushroom head | Red | Hand | 10250TA42 |
| | Red | Spring loaded | 10250TA45 |
| Jumbo head ③ | Red | Hand | 10250TA52 |
| | Red | Spring loaded | 10250TA55 |
| | Red (EMERG. STOP) | Spring loaded | 10250ED952 |

Padlockable in the Up Position ②

10250TA4_



| Operator Type | Color | Latch Type | Catalog Number |
|---------------|-------|------------|----------------|
| Mushroom head | Black | Hand | 10250TA41 |
| | Green | Hand | 10250TA43 |

10250TA5_



| | | | |
|-----------------------|--------|------|-----------|
| Jumbo mushroom head ③ | Black | Hand | 10250TA51 |
| | Green | Hand | 10250TA53 |
| | Yellow | Hand | 10250TA54 |

Notes

Hand attachment must be manually moved into place for locking. Spring loaded: when operator is pressed—attachment springs into place. Must be moved manually to release button.

① NC contacts must be mounted behind lock-down mushroom head operator to ensure lockout.

② Operators can be latched down without a padlock. Padlock not included.

③ Jumbo mushroom heads are not recommended for use in applications where exposure to ultraviolet light exists.

Key Pushbutton Operator

UL (NEMA) Type 3, 3R, 4, 4X, 12, 13

These devices incorporate an integral locking mechanism which enables locking units in various positions (**Locked Down**), locking units to

prevent operation (**Locked Up**) or setting unit to lock when the button is pressed (**Push to Lock**), requiring the key to be inserted to return to

normal operation. With the key in the center position, these operators function as a normal momentary pushbutton (**Free**).

Replacement Keys or Dissimilar Locks for Key Operators Below

Listed operators have identical locks and keys (Key Code H661) Catalog Number 10250ED824. For dissimilar lock and key combinations, see listing on **Page V7-T1-242**.

Replacement Keys

| Description | Catalog Number |
|------------------------------|----------------|
| Replacement keys (code H661) | 10250ED824 |

10250T43



Key Pushbutton Operator

Key Position and Pushbutton Operations



Key Removal Positions

Vertical Mounting^① Catalog Number

Three-Position

| | | | | |
|---------|------|-----------|---------|-----------|
| Lock up | Free | Lock down | All | 10250T430 |
| Lock up | Free | Lock down | L and R | 10250T431 |
| Lock up | Free | Lock down | C and R | 10250T432 |

Two-Position

| | | | | |
|---------|------|--------------|---------|-----------|
| Lock up | Free | — | L and C | 10250T433 |
| Lock up | Free | — | L | 10250T434 |
| — | Free | Lock down | C and R | 10250T435 |
| — | Free | Lock down | R | 10250T436 |
| — | Free | Push to lock | C and R | 10250T437 |
| — | Free | Push to lock | R | 10250T438 |

Latch-In, Twist-to-Release Operator

UL (NEMA) Type 3, 3R, 4, 4X, 12, 13

10250ED1043-4



Operator Only with Button

| Description | Catalog Number |
|---|----------------|
| Latch-in, twist-to-release operator with red mushroom head button | 10250ED1043-4 |

Note

① Horizontal mounting available on request.

1

Illuminated Momentary Pushbutton Units

UL (NEMA) Type 3, 3R, 4, 4X, 12, 13

- LED or incandescent
- Full voltage, resistor or transformer type
- Plastic lenses

24V Full Voltage Illuminated Pushbutton



Illuminated Pushbutton Units

| Type | Voltage | Color | LED/Lamp Number | Illuminated Pushbutton | | | | |
|--------------------------|-------------|-------------|-------------------|------------------------|------------------------|--------------------|-------------------|-----------------|
| | | | | 1NO Catalog Number | 1NO-1NC Catalog Number | 1NC Catalog Number | | |
| LED Lamp | | | | | | | | |
| Full voltage | 24 Vac/Vdc | Red | Bayonet base | 10250T397LRD24-53 | 10250T397LRD24-1 | 10250T397LRD24-51 | | |
| | | Green | | 10250T397LGD24-53 | 10250T397LGD24-1 | 10250T397LGD24-51 | | |
| | | Amber | | 10250T397LAD24-53 | 10250T397LAD24-1 | 10250T397LAD24-51 | | |
| | | Yellow | | 10250T397LYD24-53 | 10250T397LYD24-1 | 10250T397LYD24-51 | | |
| | | Blue | | 10250T397LLD24-53 | 10250T397LLD24-1 | 10250T397LLD24-51 | | |
| | | White | | 10250T397LWD24-53 | 10250T397LWD24-1 | 10250T397LWD24-51 | | |
| | | 120 Vac/Vdc | | Red | 10250T397LRD2A-53 | 10250T397LRD2A-1 | 10250T397LRD2A-51 | |
| | | | | Green | 10250T397LGD2A-53 | 10250T397LGD2A-1 | 10250T397LGD2A-51 | |
| | | | | Amber | 10250T397LAD2A-53 | 10250T397LAD2A-1 | 10250T397LAD2A-51 | |
| | Yellow | | 10250T397LYD2A-53 | 10250T397LYD2A-2 | 10250T397LYD2A-51 | | | |
| | Blue | | 10250T397LLD2A-53 | 10250T397LLD2A-1 | 10250T397LLD2A-51 | | | |
| | White | | 10250T397LWD2A-53 | 10250T397LWD2A-1 | 10250T397LWD2A-51 | | | |
| | Transformer | | 120 Vac | Red | 10250T411LRD06-53 | 10250T411LRD06-1 | 10250T411LRD06-51 | |
| | | | | Green | 10250T411LGD06-53 | 10250T411LGD06-1 | 10250T411LGD06-51 | |
| | | | | Amber | 10250T411LAD06-53 | 10250T411LAD06-1 | 10250T411LAD06-51 | |
| | | Yellow | | 10250T411LYD06-53 | 10250T411LYD06-1 | 10250T411LYD06-51 | | |
| | | Blue | | 10250T411LLD06-53 | 10250T411LLD06-1 | 10250T411LLD06-51 | | |
| | | White | | 10250T411LWD06-53 | 10250T411LWD06-1 | 10250T411LWD06-51 | | |
| Incandescent Lamp | | | | | | | | |
| Full voltage | | 24 Vac/Vdc | | Red | #757 | 10250T476C21-53 | 10250T476C21-1 | 10250T476C21-51 |
| | | | | Green | | 10250T476C22-53 | 10250T476C22-1 | 10250T476C22-51 |
| | Amber | | 10250T476C43-53 | 10250T476C43-1 | | 10250T476C43-51 | | |
| | Yellow | | 10250T476C23-53 | 10250T476C23-1 | | 10250T476C23-51 | | |
| | Blue | | 10250T476C24-53 | 10250T476C24-1 | | 10250T476C24-51 | | |
| | Clear | | 10250T476C25-53 | 10250T476C25-1 | | 10250T476C25-51 | | |
| | White | | 10250T476C26-53 | 10250T476C26-1 | | 10250T476C26-51 | | |
| | Resistor | 120 Vac/Vdc | Red | 120MB | 10250T471C21-53 | 10250T471C21-1 | 10250T471C21-51 | |
| | | | Green | | 10250T471C22-53 | 10250T471C22-1 | 10250T471C22-51 | |
| | | | Amber | | 10250T471C43-53 | 10250T471C43-1 | 10250T471C43-51 | |
| | | | Yellow | | 10250T471C23-53 | 10250T471C23-1 | 10250T471C23-51 | |
| | | | Blue | | 10250T471C24-53 | 10250T471C24-1 | 10250T471C24-51 | |
| | | | Clear | | 10250T471C25-53 | 10250T471C25-1 | 10250T471C25-51 | |
| | | | White | | 10250T471C26-53 | 10250T471C26-1 | 10250T471C26-51 | |
| | | | Transformer | | 120 Vac | Red | #755 | 10250T75R ① |
| Green | 10250T75G ① | 10250T76G ① | | 10250T77G ① | | | | |
| Amber | 10250T75A ① | 10250T76A ① | | 10250T77A ① | | | | |
| Yellow | 10250T75Y ① | 10250T76Y ① | | 10250T77Y ① | | | | |
| Blue | 10250T75B ① | 10250T76B ① | | 10250T77B ① | | | | |
| Clear | 10250T75C ① | 10250T76C ① | | 10250T77C ① | | | | |
| White | 10250T75W ① | 10250T76W ① | | 10250T77W ① | | | | |

Note

① For flashing module catalog number 10250TFL1, add suffix code **FM** to listed catalog number. Example: 10250T75R**FM**.

Indicating Light Units ①

UL (NEMA) Type 3, 3R, 4, 4X, 12, 13

- LED or incandescent
- Full voltage, resistor or transformer type
- Standard and PresTest types
- Plastic lenses

PresTest—This device incorporates a press-to-test feature whereby depressing the lens disconnects the light from the source being

monitored and connects the lamp to a continuously energized circuit for immediate detection of faulty lamps.

24V Full Voltage Illuminated Light



120 Vac Transformer PresTest



Indicating Light Units

| Type | Voltage | Color | LED/Lamp Number | Indicating Light Catalog Number | PresTest Catalog Number | | |
|--------------------------|-------------|----------------|-----------------|---------------------------------|-------------------------|----------------|---------------|
| LED Lamp | | | | | | | |
| Full voltage | 24 Vac/Vdc | Red | Bayonet base | 10250T197LRP24 | 10250T297LRP24 | | |
| | | Green | | 10250T197LGP24 | 10250T297LGP24 | | |
| | | Amber | | 10250T197LAP24 | 10250T297LAP24 | | |
| | | Yellow | | 10250T197LYP24 | 10250T297LYP24 | | |
| | | Blue | | 10250T197LLP24 | 10250T297LLP24 | | |
| | | White | | 10250T197LWP24 | 10250T297LWP24 | | |
| | | 120 Vac | | Red | 10250T197LRP2A | 10250T297LRP2A | |
| | | | | Green | 10250T197LGP2A | 10250T297LGP2A | |
| | Amber | | 10250T197LAP2A | 10250T297LAP2A | | | |
| | Yellow | | 10250T197LYP2A | 10250T297LYP2A | | | |
| | Blue | | 10250T197LLP2A | 10250T297LLP2A | | | |
| | White | | 10250T197LWP2A | 10250T297LWP2A | | | |
| | Transformer | | 120 Vac | Red | 10250T181LRP06 | 10250T221LRP06 | |
| | | | | Green | 10250T181LGP06 | 10250T221LGP06 | |
| | | Amber | | 10250T181LAP06 | 10250T221LAP06 | | |
| | | Yellow | | 10250T181LYP06 | 10250T221LYP06 | | |
| Blue | | 10250T181LLP06 | | 10250T221LLP06 | | | |
| White | | 10250T181LWP06 | | 10250T221LWP06 | | | |
| Incandescent Lamp | | | | | | | |
| Full voltage | | 24 Vac/Vdc | | Red | #757 | 10250T206NC1N | 10250T235NC21 |
| | Green | | 10250T206NC2N | 10250T235NC22 | | | |
| | Amber | | 10250T206NC19N | 10250T235NC43 | | | |
| | Yellow | | 10250T206NC3N | 10250T235NC23 | | | |
| | Blue | | 10250T206NC4N | 10250T235NC24 | | | |
| | Clear | | 10250T206NC5N | 10250T235NC25 | | | |
| | White | | 10250T206NC6N | 10250T235NC26 | | | |
| | Resistor | 120 Vac/Vdc | Red | 120MB | 10250T201NC1N | 10250T231NC21 | |
| | | | Green | | 10250T201NC2N | 10250T231NC22 | |
| | | | Amber | | 10250T201NC19N | 10250T231NC43 | |
| | | | Yellow | | 10250T201NC3N | 10250T231NC23 | |
| | | | Blue | | 10250T201NC4N | 10250T231NC24 | |
| | | | Clear | | 10250T201NC5N | 10250T231NC25 | |
| | | | White | | 10250T201NC6N | 10250T231NC26 | |
| Transformer ② | 120 Vac | Red | #755 | 10250T34R | 10250T74NR | | |
| | | Green | | 10250T34G | 10250T74NG | | |
| | | Amber | | 10250T34A | 10250T74NA | | |
| | | Yellow | | 10250T34Y | 10250T74NY | | |
| | | Blue | | 10250T34B | 10250T74NB | | |
| | | Clear | | 10250T34C | 10250T74NC | | |
| | | White | | 10250T34W | 10250T74NW | | |

Notes

- ① Standard indicating lights are rated UL (NEMA) 3S as well.
- ② For flashing lamp add letter **F** to listed catalog number. Example: 10250T34RF.

1

Illuminated Pushbuttons and Indicating Lights

- LED or incandescent
- Full voltage, resistor or transformer type

Illuminated Pushbutton



Operators without Lens

Indicating Light



PresTest



Master Test



| Type | Voltage | LED/Lamp Number | Illuminated Pushbutton Catalog Number | Indicating Light Catalog Number | PresTest Catalog Number | Master Test Catalog Number |
|---|---------|-----------------|---------------------------------------|---------------------------------|-------------------------|----------------------------|
| Incandescent Unit | | | | | | |
| Full voltage AC/DC | 6 | #755 | 10250T473 | 10250T203N | 10250T232N | — |
| | 12 | #756 | 10250T474 | 10250T204N | 10250T233N | — |
| | 24 | #757 | 10250T476 | 10250T206N | 10250T235N | — |
| | 32 | #1828 | 10250T477 | 10250T207N | 10250T238N | — |
| | 48 | #1835 | 10250T478 | 10250T208N | 10250T239N | — |
| Resistor AC/DC ^② | 120 | 120MB | 10250T471 | 10250T201N | 10250T231N | — |
| | 240 | 120MB | 10250T472 | 10250T202N | 10250T240N | — |
| Transformer AC only ^③ | 24 | #755 | 10250T416 | — | — | — |
| | 120 | | 10250T411 | 10250T181N | 10250T221N | — |
| | 240 | | 10250T422 | 10250T182N | 10250T222N | — |
| | 277 | | 10250T419 | 10250T198N | — | — |
| | 380 | | 10250T413 | 10250T183N | 10250T223N | — |
| | 480 | | 10250T414 | 10250T184N | 10250T224N | — |
| Neon AC/DC ^④ | 120 | NE51H-R22 | — | 10250T226N | — | — |
| | 240 | NE51H-R68 | — | 10250T227N | — | — |
| Solid-state 50/60 Hz only | 120 | 120MB | — | — | — | 10250T189N |
| LED (LEDs not included) ^① | | | | | | |
| Full voltage | — | Bayonet base | 10250T397L | 10250T197L | 10250T297L | — |
| Transformer AC only | 24 | | 10250T416L | — | — | — |
| | 120 | | 10250T411L | 10250T181L | 10250T221L | — |
| | 240 | | 10250T412L | 10250T182L | 10250T222L | — |
| | 277 | | 10250T419L | 10250T198L | — | — |
| | 380 | | 10250T413L | 10250T183L | 10250T223L | — |
| | 480 | | 10250T414L | 10250T184L | 10250T224L | — |
| | 600 | | 10250T415L | 10250T185L | 10250T225L | — |

Notes

- ① These units do not include lamps. Order LED separately to match lens color. See **Page V7-T1-269** for LED Selection and **Page V7-T1-216** for Catalog Numbering System.
- ② Resistor units are not available for use with LEDs, choose either transformer or full voltage LED style.
- ③ For flashing lamp, add letter **F** to listed catalog number. Example: 10250T181NF.
- ④ Resistant to shock and vibration. For best illumination use amber, yellow or clear lens.

Plastic

Indicating and Master Test Lenses



| Color | Plastic Catalog Number | Glass Catalog Number |
|--------|------------------------|----------------------|
| Red | 10250TC1N | 10250TC7N |
| Green | 10250TC2N | 10250TC8N |
| Amber | 10250TC19N | 10250TC9N |
| Yellow | 10250TC3N | — |
| Blue | 10250TC4N | 10250TC10N |
| Clear | 10250TC5N | 10250TC11N |
| White | 10250TC6N | 10250TC12N |

Glass



Illuminated Pushbutton Lenses

10250TC2



| Color | Catalog Number |
|--------|----------------|
| Red | 10250TC21 |
| Green | 10250TC22 |
| Yellow | 10250TC23 |
| Amber | 10250TC43 |
| Blue | 10250TC24 |
| Clear | 10250TC25 |
| White | 10250TC26 |

Plastic

PresTest Lenses



| Color | Plastic Catalog Number | Glass Catalog Number |
|--------|------------------------|----------------------|
| Red | 10250TC21 | 10250TC13N |
| Green | 10250TC22 | 10250TC14N |
| Amber | 10250TC43 | 10250TC15N |
| Yellow | 10250TC23 | — |
| Blue | 10250TC24 | 10250TC16N |
| Clear | 10250TC25 | 10250TC17N |
| White | 10250TC26 | 10250TC18N |

Glass



1 Push-Pull Emergency Stops (Compliant with IEC 60947-5-5)

UL (NEMA) Type 3, 3R, 4, 4X, 12, 13

- Two- and three-position
- Non-illuminated
- LONC contact block

10250T579C47-71X**Two-Position Push-Pull Units****Operator Position** ①

| Pull | Push | Button Type/Color | Lamp | Type | Voltage | Catalog Number |
|------|------|-----------------------------------|--------------|--------------|-------------|---------------------------|
| X | 0 | 40 mm red—illuminated | Incandescent | Transformer | 120 Vac/Vdc | 10250T563C47-71X |
| X | 0 | 40 mm red—illuminated EMERG. STOP | Incandescent | Transformer | 120 Vac/Vdc | 10250T563C53-71X |
| X | 0 | 40 mm red—illuminated EMERG. STOP | LED | Transformer | 120 Vac/Vdc | 10250T563LED06-71X |
| X | 0 | 40 mm red—illuminated | Incandescent | Full voltage | 24 Vdc | 10250T579C47-71X |
| X | 0 | 40 mm red—illuminated EMERG. STOP | Incandescent | Full voltage | 24 Vdc | 10250T579C53-71X |
| X | 0 | 40 mm red—illuminated | Incandescent | Resistor | 120 Vac/Vdc | 10250T580C47-71X |
| X | 0 | 40 mm red—illuminated EMERG. STOP | Incandescent | Resistor | 120 Vac/Vdc | 10250T580C53-71X |
| X | 0 | 40 mm red—illuminated | Incandescent | Transformer | 24 Vac | 10250T589C47-71X |
| X | 0 | 40 mm red—illuminated EMERG. STOP | Incandescent | Transformer | 24 Vac | 10250T589C53-71X |
| X | 0 | 40 mm red—illuminated EMERG. STOP | LED | Transformer | 24 Vac | 10250T589LED06-71X |
| X | 0 | 40 mm red—illuminated | LED | Transformer | 24 Vac | 10250T589LRD06-71X |
| X | 0 | 40 mm red—illuminated EMERG. STOP | LED | Full voltage | 24 Vdc | 10250T597LED24-71X |
| X | 0 | 40 mm red—illuminated EMERG. STOP | LED | Full voltage | 120 Vac/Vdc | 10250T597LED2A-71X |
| X | 0 | 40 mm red—illuminated | LED | Full voltage | 24 Vdc | 10250T597LRD24-71X |
| X | 0 | 40 mm red—illuminated | LED | Full voltage | 120 Vac/Vdc | 10250T597LRD2A-71X |
| X | 0 | 40 mm red | — | — | — | 10250T5B62-71X |
| X | 0 | 40 mm red—EMERG. STOP | — | — | — | 10250T5B63-71X |
| X | 0 | 65 mm red | — | — | — | 10250T5J62-71X |
| X | 0 | 65 mm red—EMERG. STOP | — | — | — | 10250T5J63-71X |

Note

① X = closed circuit, 0 = open circuit.

UL (NEMA) Type 3, 3R, 4, 4X, 12, 13

Two-Position Push-Pull Units

Operator Position ^①

Pull



Push



Button Type/Color ^②

Contact Type









Mounting Location

A



B

Catalog Number ^②

Two-Position Maintained Push, Maintained Pull

| | | | | | | |
|--|---|---|---|-----|---|----------------------|
| 10250T5B62-1X  | 0 | X | 40 mm/red | 1NO |  | 10250T5B62-1X |
| | X | 0 | | 1NC | | |
| 10250T5B63-1X  | 0 | X | 40 mm engraved EMERG. STOP/red | 1NO |  | 10250T5B63-1X |
| | X | 0 | | 1NC | | |
| 10250T5J63-1X  | 0 | X | 65 mm aluminum engraved EMERG. STOP/red | 1NO |  | 10250T5J63-1X |
| | X | 0 | | 1NC | | |
| 10250ED1080-2  | 0 | X | 65 mm aluminum engraved EMERG. STOP/red Special security jumbo mushroom head | 1NO |  | 10250ED1080-2 |
| | X | 0 | | 1NC | | |

Button and Color Selection

| | Color | Suffix Code | Catalog Number |
|---|---|-------------|------------------|
| Standard  | Standard—40 mm | | |
| | Red | B62 | 10250TB62 |
| | Red (EMERG. STOP) | B63 | 10250TB63 |
| | Green | B61 | 10250TB61 |
| | Black | B60 | 10250TB60 |
| | Blue | B64 | 10250TB64 |
| Jumbo Mushroom Head  | Jumbo Mushroom Head ^③ (Anodized) Aluminum—65 mm | | |
| | Red | J62 | 10250TJ62 |
| | Red (EMERG. STOP) | J63 | 10250TJ63 |
| | Green | J61 | 10250TJ61 |
| | Black | J60 | 10250TJ60 |
| | Yellow | J64 | 10250TJ64 |

Notes

^① X = closed circuit, 0 = open circuit.

^② To order different type or color buttons, substitute the underlined characters with appropriate suffix code from the table.
Example: 10250TB64-1X.

^③ Anodized aluminum head is not suitable for use in ultraviolet light applications.

UL (NEMA) Type 3, 3R, 4, 4X, 12, 13

10250T_

Three-Position Push-Pull Units

Operator Position ^①



| Pull | Intermediate | Push | Button Type/Color ^② | Contact Type | Mounting Location | | Catalog Number ^② |
|--|--------------|------|--------------------------------|--------------|-------------------|---|------------------------------|
| | | | | | A | B | |
| Maintained Push, Momentary Pull | | | | | | | |
| X | 0 | 0 | 40 mm/black | 1NC | | | 10250T9<u>B</u>60-3X |
| X | X | 0 | 40 mm/red | 1NC | | | 10250T9<u>B</u>62-3X |
| | | | 40 mm engraved EMERG. STOP/red | | | | 10250T9<u>B</u>63-3X |
| Momentary Push, Momentary Pull | | | | | | | |
| X | 0 | 0 | 40 mm/black | 1NC | | | 10250T4<u>B</u>60-3X |
| X | X | 0 | 40 mm/red | 1NC | | | 10250T4<u>B</u>62-3X |
| 0 | 0 | X | 40 mm/black | 1NO | | | 10250T10<u>B</u>60-1X |
| X | 0 | 0 | 40 mm/red | 1NC | | | 10250T10<u>B</u>62-1X |

Button and Color Selection

| Color | Suffix Code | Catalog Number |
|---|-------------|------------------|
| Standard—40 mm | | |
| Red | B62 | 10250TB62 |
| Red (EMERG. STOP) | B63 | 10250TB63 |
| Green | B61 | 10250TB61 |
| Black | B60 | 10250TB60 |
| Blue | B64 | 10250TB64 |
| Jumbo Mushroom Head ^③ (Anodized) Aluminum—65 mm | | |
| Red | J62 | 10250TJ62 |
| Red (EMERG. STOP) | J63 | 10250TJ63 |
| Green | J61 | 10250TJ61 |
| Black | J60 | 10250TJ60 |
| Yellow | J64 | 10250TJ64 |

Notes

- ① X = closed circuit, 0 = open circuit.
- ② To order different type or color buttons, substitute the underlined characters with appropriate suffix code from the table. Example: 10250T5B64-1X.
- ③ Anodized aluminum head is not suitable for use in ultraviolet light applications.

Standard



Jumbo Mushroom Head



Illuminated Push-Pull Units

UL (NEMA) Type 3, 3R, 4, 4X, 12, 13

- LED or incandescent
- Full voltage, resistor or transformer type
- Two-position maintained

Two-Position Push-Pull Operator



Two-Position Illuminated Maintained Push, Maintained Pull

Operator Position ①

| Maintained—Pull | Maintained—Push | Lamp | Type | Voltage | Contact Type | Mounting Location A | Mounting Location B | LED/Lamp Number | Red Standard Push-Pull Catalog Number ② |
|-----------------|-----------------|--------------|--------------|-------------|--------------|---------------------|--------------------------|------------------------|---|
| 0 | X | LED | Full Voltage | 24 Vac/Vdc | 1NO | | | Bayonet base | 10250T597LRD24-1X |
| X | 0 | | | 120 Vac/Vdc | 1NC | | | | 10250T597LRD24A-1X |
| | | | Transformer | 24 Vac | | | 10250T589LRD06-1X | | |
| | | | | 120 Vac | | | 10250T563LRD06-1X | | |
| 0 | X | Incandescent | Full voltage | 24 Vac/Vdc | 1NO | | | #757 | 10250T579C47-1X |
| X | 0 | | | 120 Vac/Vdc | 1NC | | | 120MB | 10250T580C47-1X |
| | | | Transformer | 24 Vac | | | #755 | 10250T589C47-1X | |
| | | | | 120 Vac | | | 10250T563C47-1X | | |

10250ED137_

Jumbo Lens Illuminated E-Stops



| Lamp | Button Type/Color | Type | Voltage | Contact Type | Catalog Number |
|------|--|--------------|------------|--------------|--------------------|
| LED | Two-position illuminated maintained push/pull— 50 mm jumbo lens/red | Full voltage | 24 Vac/Vdc | 1NO 1NC | 10250ED1375 |
| LED | Three-position illuminated momentary push/pull— 50 mm jumbo lens/red | Full voltage | 24 Vac/Vdc | 1NC 1NC | 10250ED1376 |
| LED | Three-position illuminated momentary push/pull— 50 mm jumbo lens/red | Full voltage | 24 Vac/Vdc | 1NO 1NC | 10250ED1377 |
| LED | Three-position illuminated maintained push/momentary pull— 50 mm lens/red | Full voltage | | 1NO 1NC | 10250ED1378 |





Notes

① X = closed circuit, 0 = open circuit.

② To order different type or color lens, substitute the underlined characters with appropriate suffix code from table on next page. Example: 10250T579C63-1X.
For LEDs with different voltages see ordering example on **Page V7-T1-235**.

UL (NEMA) Type 3, 3R, 4, 4X, 12, 13

Lens and Color Selection

| | Color | Incandescent Suffix Code | LED Suffix Code | Catalog Number |
|--|--|-----------------------------|--------------------|----------------|
| Standard  | Standard—40 mm | | | |
| | Red | C47 | RD | 10250TC47 |
| | Red (EMERG. STOP) | C53 | ED | 10250TC53 |
| | Green | C48 | GD | 10250TC48 |
| | Blue | C49 | LD | 10250TC49 |
| | Amber | C50 | AD | 10250TC50 |
| | White | C51 | WD | 10250TC51 |
| | Clear | C52 | CD | 10250TC52 |
| Side-Lighted Aluminum  | Side-Lighted Aluminum—40 mm ① | | | |
| | Red | C57 | RS | 10250TC57 |
| | Red (EMERG. STOP) | C63 | ES | 10250TC63 |
| | Green | C58 | GS | 10250TC58 |
| | Blue | C59 | LS | 10250TC59 |
| | Amber | C64 | AS | 10250TC64 |
| | Yellow | C60 | YS | 10250TC60 |
| | White | C61 | WS | 10250TC61 |
| Clear | C62 | CS | 10250TC62 | |
| Aluminum Transparent Center  | Aluminum Transparent Center—40 mm ① | | | |
| | Red | C65 | RH | 10250TC65 |
| | Green | C66 | GH | 10250TC66 |
| Jumbo Lens  | Jumbo Lens—50 mm | | | |
| | Red | — | — | 10250TC77 |

Note

① Clear anodized aluminum and colored lens.

UL (NEMA) Type 3, 3R, 4, 4X, 12, 13

Three-Position Push-Pull Operator



Three-Position Illuminated Momentary Push, Momentary Pull

Operator Position ①

| Momentary— Pull | Maintained— Intermediate | Momentary— Push | Lamp | Type | Voltage | Contact Type | Mounting Location | | LED/ Lamp Number | Red Standard Push-Pull Catalog Number ③ |
|--------------------|-----------------------------|--------------------|-------------------|--------------|-------------|--------------------------|---------------------------|---------------------------|-------------------------|---|
| | | | | | | | A | B | | |
| 0 | 0 | X | LED | Full voltage | 24 Vac/Vdc | 1NO | | | Bayonet base | 10250T1097LRD24-1X |
| X | 0 | 0 | | | 120 Vac | 1NC | | | | 10250T1097LRD2A-1X |
| | | | | | Transformer | 24 Vac | | 10250T1089LRD06-1X | | |
| | | | | 120 Vac | | | 10250T1063LRD06-1X | | | |
| X | 0 | 0 | | Full voltage | 24 Vac/Vdc | 1NC | | | Bayonet base | 10250T497LRD24-3X |
| X | X | 0 | | | | 1NC | | | | 10250T497LRD2A-3X |
| | | | Transformer | | | 24 Vac | | 10250T489LRD06-3X | | |
| | | | 120 Vac | | | 10250T463LRD06-3X | | | | |
| 0 | 0 | X | Incan- descent | Full voltage | 24 Vac/Vdc | 1NO | | | #757 | 10250T1079C47-1X |
| X | 0 | 0 | | | 120 Vac | 1NC | | | 10250T1080C47-1X | |
| | | | | | Transformer | 24 Vac | | #755 | 10250T1089C47-1X | |
| | | | | 120 Vac | | | 10250T1063C47-1X | | | |
| X | 0 | 0 | | Full voltage | 24 Vac/Vdc | 1NC | | | #757 | 10250T479C47-3X |
| X | X | 0 | | | | 1NC | | | 10250T480C47-3X | |
| | | | Transformer | | | 24 Vac | | #755 | 10250T489C47-3X | |
| | | | 120 Vac | | | 10250T463C47-3X | | | | |

Three-Position Push-Pull Operator



Three-Position Illuminated Maintained Push, Momentary Pull

Operator Position ①

| Momentary— Pull | Maintained— Intermediate | Momentary— Push | Lamp | Type | Voltage | Contact Type | Mounting Location | | LED/ Lamp Number | Red Standard Push-Pull Catalog Number ② | |
|--------------------|-----------------------------|--------------------|-------------|-------------------|--------------|------------------------|--------------------------|--------------------------|------------------------|---|------------------------|
| | | | | | | | A | B | | | |
| X | 0 | 0 | LED | Full voltage | 24 Vac/Vdc | 1NC | | | Bayonet base | 10250T997LRD24-3X | |
| X | X | 0 | | | 120 Vac | 1NC | | | | 10250T997LRD2A-3X | |
| | | | | | Transformer | 24 Vac | | 10250T989LRD06-3X | | | |
| | | | | 120 Vac | | | 10250T963LRD06-3X | | | | |
| X | 0 | 0 | | Incan- descent | Full voltage | 24 Vac/Vdc | 1NC | | | #757 | 10250T979C47-3X |
| X | X | 0 | | | | 120 Vac | 1NC | | | 10250T980C47-3X | |
| | | | Transformer | | | 24 Vac | | #755 | 10250T989C47-3X | | |
| | | | 120 Vac | | | 10250T963C47-3X | | | | | |

Notes

- ① X = closed circuit, 0 = open circuit.
- ② To order different type or color lens, substitute the underlined characters with appropriate suffix code from table on **Page V7-T1-230**. Example: 10250T1079C53-1X. For LEDs with different voltages see ordering example on **Page V7-T1-235**.
- ③ To order different type or color lens, substitute the underlined characters with appropriate suffix code from table on **Page V7-T1-230**. Example: 10250T979C53X. For LEDs with different voltages see ordering example on **Page V7-T1-235**.

Potentiometers

UL (NEMA) Type 3, 3R, 4, 4X, 12, 13

Vertical or Horizontal
One-Hole Mounting ^①**Potentiometer with Knob and Standard Dial Plate—Linear Type $\pm 10\%$**

| Potentiometer Ohms | Catalog Number |
|---|------------------|
| 2 Watt (60V Max.) Single Potentiometer with Standard Aluminum Dial Plate ^{②③} | |
| 1000 | 10250T331 |
| 2500 | 10250T332 |
| 5000 | 10250T338 |
| 10000 | 10250T333 |
| 25000 | 10250T334 |
| 50000 | 10250T335 |
| Operator only ^④ | 10250T330 |
| Alternative—black plastic large legend with standard markings | E34LP99 |

Notes

- ① Shown with standard aluminum dial plate.
- ② Large dial plate with space for legend is available at no charge. To order, add suffix **36** to catalog number. Example: 10250T331**36**. To order separately, see footnote ^③ below.
- ③ Large dial plate has space at top for 15 letters. 3/32 in high. For custom stamped legend plates, order legend plate as separate item **10250TR30** and specify stamping.
- ④ For use with commercially purchased potentiometers having shaft dimensions per dimension drawing on **Page V7-T1-279**.

Push-Pull Operators

An illuminated push-pull pushbutton unit, arranged for one-hole mounting, can replace two pushbuttons and a pilot light or the non-illuminated form can replace two pushbuttons. These units are available in three basic types:

- **Maintained**—(Two-position). Maintains in the pulled or pushed position until manually actuated to the opposite mode.
- **Momentary**—(Three-position). Spring returns to an intermediate position when pulled or pushed and released.
- **Momentary Pull, Maintained Push**—(Three-position). Spring returns to intermediate position when pulled. Maintains in pushed position until manually returned to intermediate (ready to reset) position. Maintained stop holds circuit open and will prevent other series connected operators from starting the system.

The operators, buttons, contact blocks, etc., are offered as building block components that can be intermixed to satisfy many requirements. This minimizes the need for a varied and costly inventory.

Two-Position Maintained Push-Pull ①



Typical Applications

| Control | Line—Diagram | Operator | Circuits | Operator Mode | | | | | | |
|---|--------------------------|--|-------------------------------|--|----------------|--------------------------|---------------|--|--|--|
| Three-wire three-position momentary | | Momentary push and pull 10250T4 | 2NC contact block 10250T3 | <table border="0"> <tr> <td>START (mom.)</td> <td>Normal pos. (maint.)</td> <td>STOP (mom.)</td> </tr> <tr> <td></td> <td></td> <td></td> </tr> </table> | START (mom.) | Normal pos. (maint.) | STOP (mom.) | | | |
| START (mom.) | Normal pos. (maint.) | STOP (mom.) | | | | | | | | |
| | | | | | | | | | | |
| Two-wire two-position maintained | | Maintained push and pull 10250T5 | 1NO-1NC contact block 10250T1 | <table border="0"> <tr> <td>START (maint.)</td> <td>No intermediate position</td> <td>STOP (maint.)</td> </tr> <tr> <td></td> <td></td> <td></td> </tr> </table> | START (maint.) | No intermediate position | STOP (maint.) | | | |
| START (maint.) | No intermediate position | STOP (maint.) | | | | | | | | |
| | | | | | | | | | | |
| Three-wire momentary pull maintained push | | Maintained push and momentary pull 10250T9 | 2NC contact block 10250T3 | <table border="0"> <tr> <td>START (mom.)</td> <td>Normal pos. (maint.)</td> <td>STOP (maint.)</td> </tr> <tr> <td></td> <td></td> <td></td> </tr> </table> | START (mom.) | Normal pos. (maint.) | STOP (maint.) | | | |
| START (mom.) | Normal pos. (maint.) | STOP (maint.) | | | | | | | | |
| | | | | | | | | | | |

Notes

A and B circuits shown in the application illustrations are defined in the "Application Guide" on the following page.
 ① Shown without button on lens.

1

Application Guide

To assist in the selection of contact blocks, the sketch to the right shows pictorially by symbols **A** and **B** locations of contact circuits after assembly of contact blocks

and adapter to the operator. The table below shows the effect of the push and pull operations on either NO or NC contacts. (X = contact closed, O = contact open).

Contact Circuit Locations

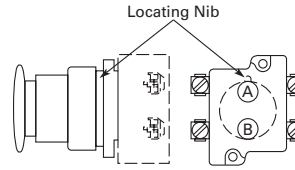

10250T579C47-71X

Push-Pull Operator Components



Operator Position and Circuit Arrangement

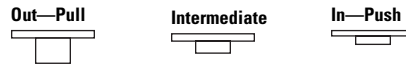

Contact Block Mounting Location

| Type of Operator | Out—Pull | | Intermediate | | In—Push | | Contact Block ① | Catalog Number |
|---|----------|---|--------------------------|---|---------|---|-----------------|--------------------|
| | A | B | A | B | A | B | | |
| Two-Position Operator without Lens | | | | | | | | |
| Maintained push-pull | O | O | No intermediate position | | X | X | 1NO | 10250T5 |
| | X or | X | | | O or | O | 1NC | |
| | O | O | | | X | X | 2NO | |
| | X | X | | | O | O | 2NC | |
| Maintained push-pull with anti-theft jumbo mushroom | O | O | No intermediate position | | X | X | 1NO | 10250ED1080 |
| | X or | X | | | O or | O | 1NC | |
| | O | O | | | X | X | 2NO | |
| | X | X | | | O | O | 2NC | |
| Three-Position Operator without Lens | | | | | | | | |
| Momentary push-pull | O | O | O | O | X | O | 1NO | 10250T4 ① |
| | X or | X | O or | X | O or | O | 1NC | |
| | O | O | O | O | X | O | 2NO | |
| | X | X | O | X | O | O | 2NC | |
| Maintained push-momentary pull | O | O | O | O | X | O | 1NO | 10250T9 ① |
| | X or | X | O or | X | O or | O | 1NC | |
| | O | O | O | O | X | O | 2NO | |
| | X | X | O | X | O | O | 2NC | |
| Momentary push-pull | O | O | O | O | X | X | 1NO | 10250T10 ① |
| | X or | X | O or | O | O or | O | 1NC | |
| | O | O | O | O | X | X | 2NO | |
| | X | X | O | O | O | O | 2ND | |

Note

① Maximum of two blocks, four circuits. Special function contact blocks shown on Page V7-T1-265 CANNOT be used with three-position push-pull operators 10250T4, 10250T9 or 10250T10.

Push-Pull Light Units, Lenses and Buttons

Ordering Example with One Composite Number

Non-illuminated:

10250T5 + 10250TB62 + 10250T1 = **10250T5B62-1X**

Incandescent:

10250T5 + 10250T79 + 10250TC47 + 10250T1 = **10250T579C47-1X**

LED:

10250T5 + 10250T97L + 10250TC47 + Voltage code + 10250T1 = **10250T597LRD24-1X**

06—6 Vac/Vdc
 12—12 Vac/Vdc
 24—24 Vac/Vdc
 48—48 Vac/Vdc

60—60 Vac/Vdc
 2A—120 Vac
 2D—120 Vdc





Light Units for Illuminated Push-Pull Devices

| Light Unit Type | Type | Voltage | LED/Lamp Number | Catalog Number |
|---|------------------------------------|--------------|-----------------|--------------------------|
| LED (LEDs not included) ^① | Full voltage | — | Bayonet base | 10250T97L |
| | Transformer AC only 50/60 Hz | 24 | | 10250T89L |
| | | 120 | | 10250T63L |
| | | 208 | | 10250T64L |
| | | 240 | | 10250T65L |
| | | 277 | | 10250T82L |
| | | 380 | | 10250T66L |
| | | 480 | | 10250T67L |
| | | 600 | | 10250T68L |
| | | Incandescent | | Full voltage AC or DC |
| 12 | 10250T70 | | | |
| 24/28 | 10250T79 | | | |
| 32 | 10250T83 | | | |
| Resistor AC or DC | 120 | | 120MB | 10250T80 |
| | 240 | | | 10250T81 |
| Transformer AC only 50/60 Hz | 24 | | #755 | 10250T89 |
| | 120 | | | 10250T63 |
| | 208 | | | 10250T64 |
| | 240 | | | 10250T65 |
| | 277 | | | 10250T82 |
| | 380 | | | 10250T66 |
| | 480 | | | 10250T67 |
| | 600 | | | 10250T68 |



Note

^① These units do not include lamps. Order LED separately to match lens color, see **Page V7-T1-269**.

Alternate Lenses for Illuminated Push-Pull Devices

| | Lens Color | Incandescent Suffix Code | LED Suffix Code ① | Catalog Number |
|---|--|--------------------------|-------------------|----------------|
| Standard  | Standard | | | |
| | Red | C47 | RD | 10250TC47 |
| | Red (EMERG. STOP) | C53 | ED | 10250TC53 |
| | Green | C48 | GD | 10250TC48 |
| | Blue | C49 | LD | 10250TC49 |
| | Amber | C50 | AD | 10250TC50 |
| | White | C51 | WD | 10250TC51 |
| | Clear | C52 | CD | 10250TC52 |
| Side-Lighted Anodized Aluminum Ring  | Side-Lighted Anodized Aluminum Ring | | | |
| | Red | C57 | RS | 10250TC57 |
| | Red (EMERG. STOP) | C63 | ES | 10250TC63 |
| | Green | C58 | GS | 10250TC58 |
| | Blue | C59 | LS | 10250TC59 |
| | Amber | C64 | AS | 10250TC64 |
| | Yellow | C60 | YS | 10250TC60 |
| | White | C61 | WS | 10250TC61 |
| | Clear | C62 | CS | 10250TC62 |
| Heavy-Duty Aluminum  | Heavy-Duty Aluminum with Transparent Center | | | |
| | Red | C65 | RH | 10250TC65 |
| | Green | C66 | GH | 10250TC66 |
| | Amber | C67 | AH | 10250TC67 |
| | White | C68 | — | 10250TC68 |
| Jumbo Lens  | Jumbo Lens—50 mm | | | |
| Red | — | — | 10250TC77 | |

Buttons for Non-Illuminated Push-Pull Devices

| | Color | Suffix Code | Catalog Number |
|---|--|-------------|----------------|
| Standard  | Standard | | |
| | Red | B62 | 10250TB62 |
| | Red (EMERG. STOP) | B63 | 10250TB63 |
| | Green | B61 | 10250TB61 |
| | Black | B60 | 10250TB60 |
| | Blue | B64 | 10250TB64 |
| Jumbo Mushroom Head  | Jumbo Mushroom Head ② (Anodized) Aluminum | | |
| | Red | J62 | 10250TJ62 |
| | Red (EMERG. STOP) | J63 | 10250TJ63 |
| | Green | J61 | 10250TJ61 |
| | Black | J60 | 10250TJ60 |
| | Yellow | J64 | 10250TJ64 |

Notes

- ① Suffix codes should only be used for assembling composite catalog numbers. To order lens above, order by catalog number.
- ② Anodized aluminum head is not suitable for use in ultraviolet light applications.

Legend Plates

For a complete listing of available legend plates see **Pages V7-T1-260 to V7-T1-262**.

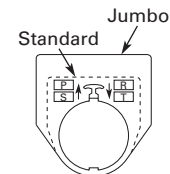

Selector Switch Units

UL (NEMA) Type 3, 3R, 4, 4X, 12, 13

- Two-, three- and four-position maintained
- Non-illuminated and illuminated

Two-Position Maintained Switch



Two-Position Selector Switch

| Operator Position ^① | | Operator Action ^② | Contact Type | Mounting Location | | Non-Illuminated | | Illuminated—120V Transformer | |
|--------------------------------|---|------------------------------|--------------|-------------------|---|--|---|--------------------------------------|---------------------------------------|
| | | | | A | B | Black Knob Catalog Number ^③ | Black Lever Catalog Number ^③ | Red Knob Catalog Number ^③ | Red Lever Catalog Number ^③ |
| X | 0 | | 1NC | | | <u>10250T20KB</u> | <u>10250T20LB</u> | <u>10250ED1117-KR</u> | <u>10250ED1117-LR</u> |
| 0 | X | | 1NO | | | | | | |

Three-Position Maintained Switch



Three-Position Selector Switch

| Operator Position ^① | | | Operator Action ^② | Contact Type | Mounting Location | | Non-Illuminated | | Illuminated—120V Transformer | |
|--------------------------------|---|---|------------------------------|--------------|-------------------|-------------------|--|---|--------------------------------------|---------------------------------------|
| | | | | | A | B | Black Knob Catalog Number ^③ | Black Lever Catalog Number ^③ | Red Knob Catalog Number ^③ | Red Lever Catalog Number ^③ |
| X | 0 | 0 | | 1NO | | <u>10250T21KB</u> | <u>10250T21LB</u> | <u>10250ED1117-2KR</u> | <u>10250ED1117-2LR</u> | |
| 0 | 0 | X | | 1NO | | | | | | |

Three-Position Maintained Switch



| | | | | | | | | | |
|---|---|---|--|--------------|--|-------------------|-------------------|------------------------|------------------------|
| X | 0 | 0 | | 1NO | | <u>10250T22KB</u> | <u>10250T22LB</u> | <u>10250ED1117-3KR</u> | <u>10250ED1117-3LR</u> |
| 0 | X | 0 | | 2NC (Series) | | | | | |
| 0 | 0 | X | | 1NO | | | | | |

Three-Position Maintained Switch



Four-Position Selector Switch

| Operator Position ^① | | | | Operator Action ^② | Contact Type | Mounting Location | | Non-Illuminated | | Illuminated—120V Transformer | |
|--------------------------------|---|---|---|------------------------------|--------------|-------------------|-------------------|--|---|--------------------------------------|---------------------------------------|
| | | | | | | A | B | Black Knob Catalog Number ^③ | Black Lever Catalog Number ^③ | Red Knob Catalog Number ^③ | Red Lever Catalog Number ^③ |
| X | 0 | 0 | 0 | | 1NC | | <u>10250T46KB</u> | <u>10250T46LB</u> | <u>10250ED1117-4KR</u> | <u>10250ED1117-4LR</u> | |
| 0 | X | 0 | 0 | | 1NO | | | | | | |
| 0 | 0 | X | 0 | | 1NO | | | | | | |
| 0 | 0 | 0 | X | | 1NC | | | | | | |

Color Selection

| Illuminated | | | | | | Non-Illuminated | | | | | |
|-------------|-------------|-------|-------------|-------|-------------|-----------------|-------------|-------|-------------|--------|-------------|
| Color | Code Letter | Color | Code Letter | Color | Code Letter | Color | Code Letter | Color | Code Letter | Color | Code Letter |
| Red | R | White | W | Amber | A | Black | B | Green | G | Blue | L |
| Green | G | Blue | B | Clear | C | Red | R | White | W | Orange | O |

Notes

- ① X = closed circuit, 0 = open circuit.
- ② M = Maintained.
- ③ To order different type or color selector switch, substitute the underlined character with appropriate suffix code from the Color Selection table. Example: 10250T20KG.

1

Selector Switch Selection



Cam and Contact Block Selection

Selector switches in their varied forms (two-position, three-position and four-position) are a big factor contributing to the great flexibility of control that a well rounded line of “pushbuttons” can achieve. Because of their flexibility, they tend to cause difficulty with product selection and application. The following systematic approach should simplify that task.

Cam and contact block selection is better understood if you:

- Work with each incoming and outgoing wire/circuit separately.
- Recognize the terms NO and NC only identify the type of contact by its mode before mounting to the operator. The “X-O” table (Page V7-T1-240) shows how that contact will act after assembly to the operator with the selected cam shape. X = closed circuit, O = open circuit.

- Up to six NO or NC contacts may be mounted behind each plunger location for a total of twelve contacts. Single circuit contact blocks have only one plunger with the other side of the block “open.” Therefore, single circuit contact blocks transmit motion to blocks behind them only for the position containing the circuit.
- Each cam has two separate lobes, each of which operates one of the two contact block plungers independently of each other. Those are identified as position A (locating nib side) and position B (opposite of locating nib). The position designations give direction in selecting and mounting of the contact blocks.

Contact Circuit Locations

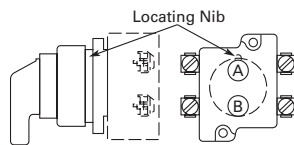

Systematic Approach

Application: **HAND-OFF-AUTO** selector switch. In this circuit, one incoming line is distributed to two other outgoing circuits by the switch. The two circuits can be looked at individually.

Step 1: Elementary Diagram.

Construct on paper, or in your mind, a simple elementary diagram of the switching scheme as follows:

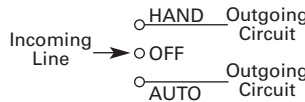

Step 2: “X-O” Pattern.

From the elementary diagram, you can construct an “X-O” diagram which describes when the contacts are to be closed (X) or open (O) in the various positions of the switch. The “X-O” for the **HAND** circuit looks like this:

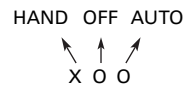

In this circuit, you want a contact closed on the left (HAND) but open in the center and right.

For the **AUTO** circuit, the “X-O” diagram would look like this:

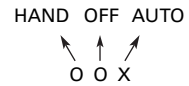

Putting them together, the complete “X-O” diagram is:



Once the “X-O” diagram has been generated the next step is to select the cam and contact block, or blocks, needed to perform the desired “X-O” functions. The selection tables on the following pages list the various types (shapes) of cams by number to choose from and the type of contact and position to achieve the function outlined in your “X-O” diagram.

Step 3: Cam Selection.

The cam you select determines the operation of all contact blocks mounted to the operator. It is selected on the basis that it provides the simplest circuitry for the desired "X-O" diagram. The selection tables show all the "X-O" combinations. For the purpose of this example, the applicable portion of those tables is shown on this page.

Now to make the cam selection, make a simple worksheet such as:

| | Cam 2 | Cam 3 |
|-------|-------------|-------|
| X O O | (A)NO-(B)NC | (A)NO |
| O O X | (B)NO | (B)NO |

It becomes immediately obvious that cam 3 is the better choice for two reasons, (1) the series combination can be avoided making it simpler to wire, (2) only two contacts are required, which is less expensive than the three contacts required by cam 2.

Step 4: Contact Block Selection.

Having selected the cam, contact block selection is simply a matter of gathering the A position and B position circuits into pairs which make up the most convenient contact block arrangement. If there is an imbalance in the number of circuits under A or B, then single circuit blocks must be selected for these leftover circuits.

Back to the worksheet, having selected cam 3 do this:



Step 5: Selector Switch Operator.

Lastly, you have to choose from the many types of operators—knob and lever in various colors or keyed. Also what combinations of maintained and spring return functions are required. Selection of these operators can be found on **Page V7-T1-242**. For the example in step 4 you may want a three-position maintained black knob, cam 3—Catalog Number 10250T1323.

The Complete Switch: 10250T1323 with one 10250T2 or, for one composite catalog number, 10250T21KB found on **Page V7-T1-237**.

Diagrams

Circuits shown illustrate connections to obtain a selector switch circuit combination and are shown with their appropriate line diagrams. Field wiring of jumper connections required as shown.

X = Closed circuit
O = Open circuit

Wiring of Jumper Connections

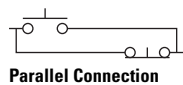

Four-position selector switches are limited to four contact blocks.

Contact Blocks

For selection and number of available contact blocks per operator, see **Pages V7-T1-265 to V7-T1-268**.

Example Selection Table

| No. | "X-O" Pattern | Cam Code #2 | | Cam Code #3 | |
|-----|---------------|-------------|----------|-------------|----------|
| | | Top A | Bottom B | Top A | Bottom B |
| 1 | X 0 0 | | | | — |
| 4 | 0 0 X | — | | — | |

Two-Position Selector Switch Contact Block Selection

| No. | Desired Circuit and Operator Position | | Contact Blocks Required to Accomplish Circuit Function | |
|-----|---------------------------------------|---|--|------------------|
| | | | Top Plunger A | Bottom Plunger B |
| 1 | X | 0 | or | |
| 2 | 0 | X | | or |

Note
① Wired in series.

1 Three-Position Switch—Cam and Contact Block Selection

| No. | Desired Circuit and Operator Position | | | Operator with Cam Code #2 | | Operator with Cam Code #3 | |
|-----|---------------------------------------|---|---|---------------------------|------------------|---------------------------|------------------|
| | | | | Mounting Location | | Mounting Location | |
| | | | | Top Plunger A | Bottom Plunger B | Top Plunger A | Bottom Plunger B |
| 1 | X | 0 | 0 | | | | |
| 2 | X | X | 0 | | | | |
| 3 | X | 0 | X | | | | |
| 4 | 0 | 0 | X | | | | |
| 5 | 0 | X | X | | | | |
| 6 | 0 | X | 0 | | | | |

Four-Position Switch—Contact Block Selection

| No. | Desired Circuit and Operator Position | | | | Mounting Location | | No. | Desired Circuit and Operator Position | | | | Mounting Location | |
|-----|---------------------------------------|---|---|---|-------------------|------------------|-----|---------------------------------------|------------------|---|---|-------------------|---|
| | | | | | Top Plunger A | Bottom Plunger B | | Top Plunger A | Bottom Plunger B | | | | |
| | 1 | X | 0 | 0 | 0 | | | | 10 | X | 0 | X | 0 |
| 2 | 0 | X | 0 | 0 | | | | | | | | | |
| 3 | 0 | 0 | X | 0 | | | 11 | X | X | X | 0 | | |
| 4 | 0 | 0 | 0 | X | | | | | | | | | |
| 5 | X | 0 | 0 | X | | | 12 | 0 | X | X | X | | |
| 6 | 0 | X | X | 0 | | | | | | | | | |
| 7 | 0 | 0 | X | X | | | 13 | X | 0 | X | X | | |
| 8 | X | X | 0 | 0 | | | | | | | | | |
| 9 | 0 | X | 0 | X | | | 14 | X | X | 0 | X | | |

Selector Switch Operators

Key Operators

UL (NEMA) Type 3, 3R, 4, 4X, 12, 13



Key Operators with Cam

| Positions | Operator Action ^② | Cam Code ^③ | Optional Key Removal Positions ^④ | Vertical Mounting Catalog Number | Horizontal Mounting Catalog Number |
|--------------------------|------------------------------|-----------------------|---|----------------------------------|------------------------------------|
| Two-position—60° throw | | 1 | 1, 2, 3 | 10250T1511_ | 10250T1611_ |
| | | 1 | 2 | 10250T1571_ | 10250T1581_ |
| Three-position—60° throw | | 2 | 1-7 | 10250T1522_ | 10250T1622_ |
| | | 3 | | 10250T1523_ | 10250T1623_ |
| | | 2 | 1, 4, 5 | 10250T1532_ | 10250T1632_ |
| | | 3 | | 10250T1533_ | 10250T1633_ |
| | | 2 | 4 | 10250T1542_ | 10250T1642_ |
| | | 3 | | 10250T1543_ | 10250T1643_ |
| Four-position—40° throw | | 2 | 2, 4, 6 | 10250T1652_ | 10250T1662_ |
| | | 3 | | 10250T1653_ | 10250T1663_ |
| | | 7 | 7 | 10250T1677_ | 10250T1687_ |

Notes

- ① Horizontal mount, key removal #1 keyed selector switch, cam 1 shown.
- ② M = Maintained. S = Spring return in direction of arrow (R).
- ③ For selection of the proper cam and contact block to obtain the proper circuit sequence, see selection instructions and tables on **Pages V7-T1-238, V7-T1-239 and V7-T1-240.**
- ④ Choose key removal position required for application from table on **Page V7-T1-242.** Add key removal code no. to listed catalog number. Example: 10250T15112.

Key Removal Positions

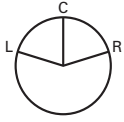

| Code Suffix | Key Removal Position |
|-------------|----------------------|
| 1 | Right only |
| 2 | Left only |
| 3 | Right and left |
| 4 | Center only |
| 5 | Right and center |
| 6 | Left and center |
| 7 | All positions |

Note: Key removal in “spring return from” positions not recommended.

Replacement Keys or Dissimilar Locks for Key Operators

Operators listed on **Page V7-T1-242** have identical locks and keys (Key Code H661) Catalog Number 10250ED824. For dissimilar lock and key combinations, see listing on this page.

Replacement Key

| Description | Catalog Number |
|------------------------------|----------------|
| Replacement keys (code H661) | 10250ED824 |

Selector Switch Operators with Dissimilar Locks and Keys (UL [NEMA] 4, 4X and 13)

The locks in all key operators listed on **Pages V7-T1-221, V7-T1-242** and **V7-T1-379** are identical and use key code number H661. Two keys are supplied with every lock. For additional code number H661 keys, order **Catalog Number 10250ED824**. For others, order 10250ED1130 and designate lock number. When dissimilar locks for each operator or each group of operators are required, select from the lock and key combination listed below. **When Ordering Operator Only** or a complete control unit with a substitute lock, order from table below and add “except Lock and Key Code No. ...”

“H” Series Locks without Master Key—with Key Slot Cover

| Lock and Key Code Numbers | | |
|---------------------------|------|------|
| H501 | H635 | H663 |
| H620 | H639 | H675 |
| H621 | H643 | H683 |
| H634 | H654 | H688 |

“M” Series Locks with Master Key—with Key Slot Cover

| Lock and Key Code Numbers | | | |
|---------------------------|------|------|------|
| MD1 | MD14 | ME8 | MJ6 |
| MD2 | MD15 | ME11 | MJ10 |
| MD3 | MD16 | ME16 | MJ11 |
| MD4 | MD19 | ME17 | MJ13 |
| MD5 | MD20 | ME18 | MJ15 |
| MD7 | ME2 | ME19 | MJ16 |
| MD9 | ME3 | MJ1 | MD17 |
| MD10 | ME5 | MJ3 | |
| MD11 | ME6 | MJ4 | |
| MD13 | ME7 | MJ5 | |

Master Keys for Above Locks

| Application | Catalog Number |
|-------------|----------------|
| For code: | |
| MD1–MD20 | 10250ED825-3 |
| ME2–ME18 | 10250ED825-4 |
| MJ1–MJ16 | 10250ED825-5 |

Selector Switch Operators with Caps

UL (NEMA) Type 3, 3R, 4, 4X, 12, 13

Selector Switch Operators with Caps

| Positions | Operator Action ^② | Black Knob Selector Switch—Vertical Mounting ^③ | | Black Lever Selector Switch—Vertical Mounting ^③ | | |
|--|------------------------------|---|----------------|--|----------------|------------|
| | | Cam Code ^④ | Catalog Number | Cam Code ^④ | Catalog Number | |
| Two-Position Maintained ^① | Two-position—60° throw | | 1 | 10250T1311 | 1 | 10250T3011 |
| | | | 1 | 10250T1371 | 1 | 10250T3071 |
| Three-Position Maintained ^⑤ | Three-position—60° throw | | 2 | 10250T1322 | 2 | 10250T3022 |
| | | | 3 | 10250T1323 | 3 | 10250T3023 |
| | | | 2 | 10250T1332 | 2 | 10250T3032 |
| | | | 3 | 10250T1333 | 3 | 10250T3033 |
| | | | 2 | 10250T1342 | 2 | 10250T3042 |
| | | | 3 | 10250T1343 | 3 | 10250T3043 |
| | | | 2 | 10250T1352 | 2 | 10250T3052 |
| | | | 3 | 10250T1353 | 3 | 10250T3053 |
| Four-position—40° throw | | 7 | 10250T1367 | 7 | 10250T3067 | |

Notes

- ① Black knob selector switch, cam 1 shown.
- ② M = Maintained. S = Spring return in direction of arrow.
- ③ Field convertible to horizontal mounting or order operator only and separate operator cap.
- ④ For selection of the proper cam and contact block to obtain the proper circuit sequence, see selection instructions and tables on **Pages V7-T1-238, V7-T1-239** and **V7-T1-240**.
- ⑤ Black lever selector switch, cam 3 shown.

Selector Switch Operators without Caps

Operators can be ordered with caps assembled to them by adding the code number from the table on this page to the end of catalog number below.
Example: 10250T4011**KB**

Two-Position Selector Switch Maintained



Selector Switch Operators without Caps

| Positions | Operator Action ① | Cam Code ② | Catalog Number |
|--------------------------|-------------------|------------|-------------------|
| Two-position—60° throw | M ↘ M | 1 | 10250T4011 |
| | M ↘ S | 1 | 10250T4081 |
| Three-position—60° throw | M ↘ M | 2 | 10250T4022 |
| | M ↘ M | 3 | 10250T4023 |
| | S ↘ M | 2 | 10250T4032 |
| | S ↘ M | 3 | 10250T4033 |
| | S ↘ S | 2 | 10250T4042 |
| | S ↘ S | 3 | 10250T4043 |
| Four-position—40° throw | M ↘ S | 2 | 10250T4052 |
| | M ↘ S | 3 | 10250T4053 |
| | M ↘ M | 7 | 10250T4067 |
| | M ↘ M | | |

Knob



Lever



Lever for Use with Maintained Operators



Coin Slot



Operating Caps

| Color | Knob Catalog and Code Number | Lever Catalog and Code Number | Color | Lever ③ Catalog and Code Number | Coin Slot Catalog and Code Number |
|--------|------------------------------|-------------------------------|--------|---------------------------------|-----------------------------------|
| Black | 10250TKB | 10250TLB | Black | 10250TSB | 10250TCB |
| Red | 10250TKR | 10250TLR | Red | 10250TSR | 10250TCR |
| Green | 10250TKG | 10250TLG | Green | 10250TSG | 10250TCG |
| Yellow | 10250TKY | 10250TLY | Yellow | 10250TSY | 10250TCY |
| White | 10250TKW | 10250TLW | White | 10250TSW | 10250TCW |
| Gray | 10250TKA | 10250TLA | Gray | 10250TSA | 10250TCA |
| Blue | 10250TKL | 10250TLL | Blue | 10250TSL | 10250TCL |
| Orange | 10250TKD | 10250TLO | Orange | 10250TSO | 10250TCO |

Notes

- ① M = Maintained. S = Spring return in direction of arrow (R).
- ② For selection of the proper cam and contact block to obtain the proper circuit sequence, see selection instructions and tables on **Pages V7-T1-238, V7-T1-239 and V7-T1-240**.
- ③ Designed for added ingress protection. For use in maintained operators only.

Illuminated Selector Switch Operators

Illuminated Selector Switches without Caps

Two-Position Selector Switch Maintained



Operator without Knob or Lever

| Positions | Operator Action ① | Transformer Type—50/60 Hz 6 Volt #755 Lamp | | | Full Voltage Type—AC or DC ④ Lamps: 6V—#755, 12V—#756, 24V—#757, 48V—#1835, 120/240V—120MB | | |
|--------------------------|-------------------|---|------------|----------------------------------|--|------------|----------------------------------|
| | | Cam Code ② | Voltage | Code Number and Catalog Number ③ | Cam Code ② | Voltage | Code Number and Catalog Number ③ |
| Two-position—60° throw | | 1 | 24 | 10250T5961 | 1 | 6 | 10250T6201 |
| | | | 120 | 10250T5971 | | 12 | 10250T6211 |
| | | | 208 | 10250T6511 | | 24 | 10250T6221 |
| | | | 240 | 10250T5981 | | 48 | 10250T6231 |
| | | | 380 | 10250T5991 | | 120 | 10250T6361 |
| | | | 480 | 10250T6001 | | 240 ⑤ | 10250T6371 |
| | | | 600 | 10250T6011 | | | |
| Three-position—60° throw | | + 2 or 3 | 24 | 10250T602_ | + 2 or 3 | 6 | 10250T624_ |
| | | | 120 | 10250T603_ | | 12 | 10250T625_ |
| | | | 208 | 10250T652_ | | 24 | 10250T626_ |
| | | | 240 | 10250T604_ | | 48 | 10250T627_ |
| | | | 380 | 10250T605_ | | 120 | 10250T638_ |
| | | | 480 | 10250T606_ | | 240 ⑤ | 10250T639_ |
| | | 600 | 10250T607_ | | | | |
| | | + 2 or 3 | 24 | 10250T654_ | + 2 or 3 | 6 | 10250T612_ |
| | | | 120 | 10250T620_ | | 12 | 10250T632_ |
| | | | 208 | 10250T655_ | | 24 | 10250T642_ |
| | | | 240 | 10250T656_ | | 48 | 10250T672_ |
| | | | 380 | 10250T657_ | | 120 | 10250T622_ |
| | | | 480 | 10250T658_ | | 240 | 10250T682_ |
| | | 600 | 10250T659_ | | | | |
| | + 2 or 3 | 24 | 10250T660_ | + 2 or 3 | 6 | 10250T613_ | |
| | | 120 | 10250T621_ | | 12 | 10250T633_ | |
| | | 208 | 10250T661_ | | 24 | 10250T643_ | |
| | | 240 | 10250T662_ | | 48 | 10250T673_ | |
| | | 380 | 10250T663_ | | 120 | 10250T623_ | |
| | | 480 | 10250T664_ | | 240 | 10250T683_ | |
| | 600 | 10250T665_ | | | | | |
| | + 2 or 3 | 24 | 10250T614_ | + 2 or 3 | 6 | 10250T628_ | |
| | | 120 | 10250T615_ | | 12 | 10250T629_ | |
| | | 208 | 10250T653_ | | 24 | 10250T630_ | |
| | | 240 | 10250T616_ | | 48 | 10250T631_ | |
| | | 380 | 10250T617_ | | 120 | 10250T640_ | |
| | | 480 | 10250T618_ | | 240 ⑤ | 10250T641_ | |
| | 600 | 10250T619_ | | | | | |
| Four-position—40° throw | | 7 | 24 | 10250T6087 | 7 | 6 | 10250T6327 |
| | | | 120 | 10250T6097 | | 12 | 10250T6337 |
| | | | 208 | 10250T6547 | | 24 | 10250T6347 |
| | | | 240 | 10250T6107 | | 48 | 10250T6357 |
| | | | 380 | 10250T6117 | | 120 | 10250T6427 |
| | | | 480 | 10250T6127 | | 240 ⑤ | 10250T6437 |
| | | | 600 | 10250T6137 | | | |

Notes

- ① M = Maintained. S = Spring return in direction of arrow (R).
- ② For selection of the proper cam and contact block, to obtain the proper circuit sequence, see selection tables on **Pages V7-T1-238, V7-T1-239 and V7-T1-240.**
- ③ Operator includes lens gasket and lens attachment screws.
- ④ Full voltage light units can be used at other than listed voltages by changing lamp. Replacement lamps are listed on **Page V7-T1-269.**
- ⑤ Resistor type. May generate excess heat if used in high density.

Knob



Lever



Illuminated Knobs and Levers

| Color ^① | Knob Code Number and Catalog Number | Lever Code Number and Catalog Number |
|--------------------|-------------------------------------|--------------------------------------|
| Red | 10250TER | 10250FR |
| Green | 10250TEG | 10250TFG |
| Yellow | 10250TEA | 10250TFA |
| Blue | 10250TEL | 10250TFL |
| Clear | 10250TEC | 10250TFC |
| White | 10250TEW | 10250TFW |
| Amber | 10250TEM | 10250TFM |

Joystick Units

Two-Position Joystick



Joystick Units—UL (NEMA) Type 3, 3R, 4, 4X, 12, 13

Operator Position ^②

| | Up | Center | Down | Operator Action ^③ | Contact Type | Mounting Location | | Two-Position Assembled Unit Catalog Number ^④ |
|---|----|--------|------|------------------------------|--------------|-------------------|---|---|
| | | | | | | A | B | |
| X | | | | | 1NC | | | 10250T452-3X |
| 0 | | | | | 1NC | | | |

Notes

- ① Amber, clear and white lenses have a black arrow (pointer), red, green and blue lenses have a white arrow (pointer).
- ② X = closed circuit, 0 = open circuit.
- ③ M = Maintained. S = Spring return in direction of arrow (R).
- ④ Field convertible momentary to maintained or vice versa.

1

Joysticks

Two-Position Joystick Operators

The device mounts in the standard 30.5 mm mounting hole. Allow sufficient panel space for lever movement.

The maximum travel of the knob operator (full up to full down) is 2.2 in (24°) momentary, 2.5 in (30°) maintained, but ample space for lever operation must be allowed. These operators are field convertible from momentary to maintained operation or vice versa.

The use of NC contacts is preferred because they provide positive drive contact opening and a direct relationship between lever movement and affected terminal, i.e., up movement affects the top terminals.

Application Caution

Joystick operators are not recommended on certain DC applications above 24 Vdc which may involve lightly engaging the contacts (teasing) to achieve speed control, positioning, jogging, etc. Excessive arcing and deterioration of the contacts will occur.

Two-Position Joystick Operator



Two-Position Joystick Operators—UL (NEMA) Type 3, 3R, 4, 4X, 12, 13

| Contact Block Limitations | Two-Position Operator Only—AC Applications Only Description ^① | Catalog Number |
|---|---|-------------------|
| Momentary Mode 4NC contact blocks max. 3NO contact blocks max. | Momentary up and down | 10250T452 |
| | Maintained up—momentary down | 10250T4521 |
| | Maintained down—momentary up | 10250T4522 |
| Maintained Mode 2 contact blocks max. | Maintained up and down | 10250T4525 |

Contact Block Operation and Selection

Handle Position ^②

| Up | Center | Down | Contact Block Type ^④ | Mounting Location ^{②③} | | Catalog Number |
|----|--------|------|---------------------------------|---------------------------------|----------|------------------------------|
| | | | | Top A | Bottom B | |
| | | | 1NC | | | 10250T51 |
| | | | 1NC | | | 10250T51 |
| | | | 2LONC (Series) | | | 10250T45 |
| | | | 1NC | | | 10250T3 |
| | | | 1NC | | | 10250T3 |
| | | | 1LONC | | | 10250T45 |
| | | | 1LONC | | | 10250T45 |
| | | | 1NC | | | 10250T44 ^⑤ |
| | | | 1NO | | | 10250T44 ^⑤ |
| | | | 1NC | | | 10250T44 ^⑤ |
| | | | 1NO | | | 10250T44 ^⑤ |

A and B Mounting Location

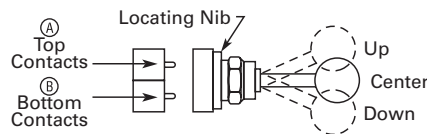

Up
NC Contact at Top Is Closed, NO at Bottom Is Closed

Center
All NC and NO Contacts Are Open (1/2 Way), Late Opening NC Is Closed

Down
NC Contact at Bottom Is Closed, NO at Top Is Closed

Notes

- ① Field convertible momentary to maintained or vice versa. To expedite shipment of maintained types, order momentary operator 10250T452 which is a stocked device.
- ② Bolded circuit corresponds to "X-O" circuit selection. X = closed circuit, O = open circuit.
- ③ See above for "A" and "B" mounting location.
- ④ NO = normally open, NC = normally closed, LONC = late opening normally closed.
- ⑤ Four circuits in single block depth—rated 300V max.

Four-Position Joystick Operators

The joystick operated control unit is intended for AC application only. For other use, see **Application** **Caution** on preceding page.

The panel area required for the four-position operator is equivalent to two standard pushbutton operators.

The latch holds the lever in the center position. The trigger latch must be released before lever can move into any position.

Four-Position Joystick Operator



Four-Position Joystick Operator with Latch



Four-Position Joystick Operators—UL (NEMA) Type 3, 3R, 4, 4X, 12, 13

| Contact Block Limitations | Description ① | Catalog Number |
|---|-----------------------------|-------------------|
| Operator Only—AC Application Only | | |
| Four contact blocks max.—two in each position | Four-position—without latch | 10250T451_ |
| | Four-position—with latch | 10250T461_ |
| Hole Plug | | |
| Four contact blocks max.—two in each position | To plug unused hole | 10250TA7 |

Field Conversion—Gate

The factory assembled four-position operator is assembled with a gate arranged for four handle positions.

Handle Positions



Four-Position Gate

Three additional gates, supplied with every operator, allow on the job conversion to three- or eight-position operation as illustrated.

Two-, Three- or Eight-Position Operation

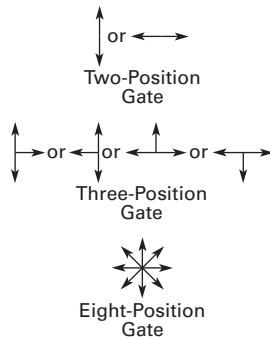

The eight-position gate controls the four functions shown as “Up,” “Down,” “Left” and “Right.” The remaining four diagonal positions each actuate two adjacent functions; for example, “Left Down” actuates both “Left” and “Down.” The operator may be arranged for spring return of handle to center position, or maintained in up to eight positions (see description of maintained position operator).

Adjacent Functions

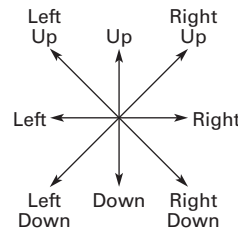

Maintained Position

For maintained position (non-spring return), locate required maintained position or positions of operating lever and add appropriate suffix number to the catalog number selected from the table above.

Maintained Positions

| Maintained Positions | | | | Suffix Number |
|----------------------|------|------|-------|---------------|
| Up | Down | Left | Right | |
| X | — | — | — | 1 |
| — | — | — | — | 2 |
| — | X | — | — | 3 |
| — | — | X | — | 4 |
| — | — | — | — | 5 |
| X | — | X | — | 6 |
| X | — | — | X | 7 |
| — | X | X | — | 8 |
| — | X | — | X | 9 |
| — | — | X | X | 10 |
| X | X | X | — | 11 |
| X | X | — | X | 12 |
| X | — | X | X | 13 |
| — | X | X | X | 14 |
| X | X | X | X | 15 |

On an eight-position gate, when an adjacent vertical and horizontal position are both maintained, the included diagonal position is also maintained.

Note

① Momentary operators—spring return to center. For maintained operators add suffix code from table on this page. Example: 10250T451**10**. Operator without latch, maintained in left and right positions.

1

Contact Block Operation

Contact blocks mount directly to the back of the operator. For reliable operation, the maximum number of contact blocks that should be installed behind each operator lever is two (four total).

The figure below identifies the circuits activated by each of the eight possible lever positions. Contact block plungers 1, 2, 3, 4 are depressed (change state) when handle is in the position indicated by arrows below.

Circuit Activation

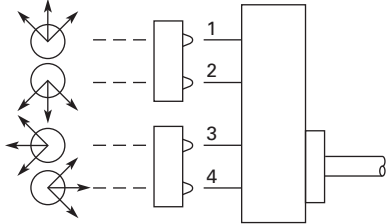

Note: Joystick in its resting state, center position, does not activate contact block plungers.

Ordering Example:

Suppose you are looking for a four-position momentary joystick without a latch and the following circuit arrangements. X = Closed Circuit, O = Open Circuit.

Example Circuit Arrangements

| Circuit | Up | Down | Left | Right |
|---------|----|------|------|-------|
| 1st | X | X | X | X |
| 2nd | X | O | O | X |

The contact blocks and their mounting locations would be as follows:

Example Contact Blocks and Locations

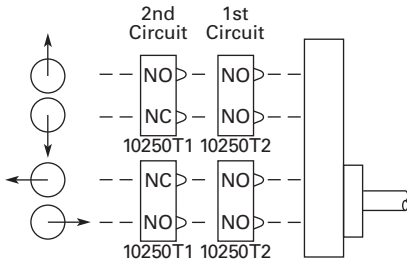

A complete bill of material for this example would include:

Example Order

| Qty. | Catalog Number |
|------|----------------|
| 1 | 10250T451 |
| 2 | 10250T2 |
| 2 | 10250T1 |

Blank Legend Plates for Joystick Operators

When ordering engraved legend plates, order by catalog number and insert the following into order notes:

- Legend required
- Size of characters: 3/16, 1/8, 3/32 in (4.8, 3.2, 2.4 mm)
- Location by letter (A–N)

Locations K and M can accommodate up to two lines horizontally; L and N up to two lines vertically.

Maximum number of characters:

- Horizontal
3/16 in—13, 1/8 in—14, 3/32 in—19
- Vertical
3/16 in—10, 1/8 in—13, 3/32 in—14

Ordering Example:

Two-position legend plate to be marked “UP” “DOWN.”

Catalog No. **10250TJ2S4STAMP**

Letter Size: 3/16 in (4.8 mm)

Pos. K—UP

Pos. M—DOWN

Two-Position

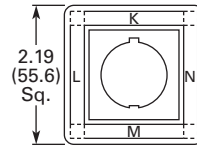

Catalog Number

Blank Plate

10250TJS3

Engraved Plate

10250TJS3STAMP

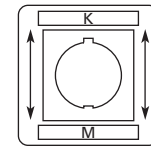

Catalog Number

Blank Plate

10250TJS4

Four-Position

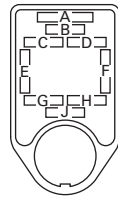

Catalog Number

Blank Plate

10250TJS1

Engraved Plate

10250TJS1STAMP

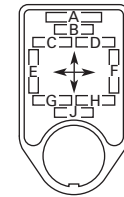

Catalog Number

Blank Plate

10250TJS2

Engraved Plate

10250TJS2STAMP

Roto-Push Units

Two-Position Momentary

Complete assembled two-position Roto-Push® Units are listed below. These operators have black flush buttons and are arranged for vertical mounting. Order legend plates separately.

Mounting Location

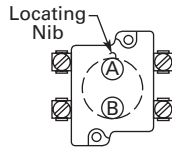

Roto-Push—Black Flush Button



Roto-Push Units—UL (NEMA) Type 3, 3R, 4, 4X, 12, 13

| Typical Applications (Most Common Examples) | Operator Position ^① Collar Left | | Collar Right | | Contact Type | Mounting Location | | Catalog Number ^② |
|--|---|-----------|--------------|-----------|--------------|-------------------|---|-----------------------------|
| | Normal | Depressed | Normal | Depressed | | A | B | |
| Two-Position FORWARD/REVERSE; HIGH/LOW; OPEN/CLOSE; UP/DOWN; etc. | 0 | 0 | 0 | X | 1NO | | | 10250T2411-2 |
| | 0 | X | 0 | 0 | 1NO | | | |
| JOG/RUN; MAN./AUTO; etc. | 0 | X | 0 | X | 1NO | | | 10250T24111-2 |
| | 0 | 0 | X | X | 1NO | | | |
| RUN/JOG; START/JOG; etc. | 0 | X | 0 | X | 1NO | | | 10250T24111-1 |
| | X | X | 0 | 0 | 1NC | | | |
| SAFE/RUN; etc. | 0 | 0 | 0 | X | 1NO | | | 10250T2415-2 |
| | 0 | 0 | X | X | 1NO | | | |

Two-Position Latched

The two-position Roto-Push Latch Unit is fully assembled and only requires a legend plate for a great variety of applications. When the selector collar is in the extreme left position, the button is in the free or normal position and can be operated as a standard pushbutton. Rotating the collar to the

extreme right position automatically depresses and latches the button in the depressed position. The white filled groove in the button indicates the selector collar position. The selector collar has spring return to the left position except when in the extreme right latched position.

Red Long



Rotates to a Latch-Out Mode

| Color and Type of Button | Contact Block | Vertical Mounting Catalog Number |
|--------------------------|---------------|----------------------------------|
| Red long | 1NC | 10250T72 |
| | 2NC | 10250T73 |

Notes

- ① X = closed circuit, 0 = open circuit.
- ② Roto-Push assembled with contact blocks.

Roto-Push Operators

Roto-Push Components

A Roto-Push control unit combines the function of a pushbutton and a selector switch. The contacts are operated by the combined action of rotating the outer collar and pushing a button contained in the collar.

In selecting the cam and contact blocks for the listed function, the analysis involves considering the function with the collar rotated to the given position with the button free (designated as “N”) and then in that same position with the button depressed (designated “D”). This is done for each rotational position of the collar.

When Ordering Specify

- Catalog number of operator with cam code suffix from tables below and on following pages, Example: 10250T2411.
- Catalog number(s) for contact blocks and legend plates if required.
- To select the cam and contact blocks needed for two-position and three-position switches, use the tables on following pages.

Operator and Cam



Operator and Cam

| Color and Type of Button | Cam Code No. Select from Tables | Vertical Mounting Catalog and Code Number | Horizontal Mounting Catalog and Code Number |
|--------------------------|---------------------------------|---|---|
| Black flush | + 1 to 18 | 10250T241_ | 10250T251_ |
| Red flush ^① | | 10250T242_ | 10250T252_ |
| Green flush | | 10250T243_ | 10250T253_ |
| Black long | | 10250T261_ | 10250T271_ |
| Red long ^① | | 10250T262_ | 10250T272_ |
| Green long | | 10250T263_ | 10250T273_ |

Two-Position Roto-Push Operator—Rotates to a Latch-Out Mode Special Rotor Latch

This differs from the other Roto-Push operators in that as the collar is rotated to the right it depresses the button and releases the button when rotated left. But the button in the released position can be momentarily pushed independent of the collar or

its position. As the button is depressed by rotating the collar, the button also rotates and indicates its mode by a white line on the button face. This button can be used as an emergency stop or latched stop.

Special Roto Latch—Red Long Button











































Special Roto Latch—UL (NEMA) Type 3, 3R, 4, 4X, 12, 13

| Color and Type of Button | Vertical Mounting Catalog Number |
|--------------------------|----------------------------------|
| Red long | 10250T3213 |
| Black long | 10250T3214 |

Note

^① Not to be used for emergency stop application.

Cam and Contact Block Selection for Two-Position Roto-Push

| Combination Number | Collar Position | | Circuit Sequence ^① | | Cam Code 1 | Cam Code 2 | Cam Code 3 | Cam Code 4 | Cam Code 5 | Cam Code 6 |
|--------------------|-----------------|---|-------------------------------|---|--|--|------------|--|--|--|
| | N | D | N | D | | | | | | |
| 1 | 0 | 0 | 0 | X | A  NO | A  NO | — | — | A  NO | — |
| 2 | 0 | 0 | X | 0 | — | — | — | A  NO B  NO | A  NO B  NO | — |
| 3 | 0 | 0 | X | X | — | — | — | — | B  NO | A  NO |
| 4 | 0 | X | 0 | 0 | B  NO | A  NO B  NO | — | — | — | A  NO B  NO |
| 5 | 0 | X | 0 | X | A  NO B  NO | B  NO | — | A  NO | — | — |
| 6 | 0 | X | X | 0 | — | — | — | — | — | — |
| 7 | 0 | X | X | X | — | — | A or B NO | B  NO | — | B  NO |
| 8 | X | 0 | 0 | 0 | — | — | A or B NC | B  NC | — | B  NC |
| 9 | X | 0 | 0 | X | — | — | — | — | — | — |
| 10 | X | 0 | X | 0 | A  NC B  NC | B  NC | — | A  NC | — | — |
| 11 | X | 0 | X | X | B  NC | A  NO B  NC | — | — | — | A  NO B  NC |
| 12 | X | X | 0 | 0 | — | — | — | — | B  NC | A  NC |
| 13 | X | X | 0 | 0 | — | — | — | A  NO B  NO | A  NO B  NO | — |
| 14 | X | X | X | 0 | A  NC | A  NC | — | — | A  NC | — |

Series and Parallel Connections

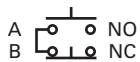

Series Connection



Parallel Connection

The connections are not made at the factory. They are illustrated in the selection table as requirements, but must be made on the job.

Circuit Location

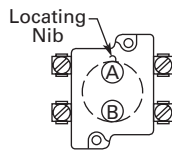

Letters "A" and "B" represent the locations which the two circuits of a contact block will occupy in relation to the locating nib of the operator.

Note

① N = Button in free or normal position. D = Button depressed.

Cam and Contact Block Selection for Two-Position Roto-Push, continued

| Combination Number | Collar Position | | Circuit Sequence ① | | Cam Code 10 | Cam Code 11 | Cam Code 12 | Cam Code 13 | Cam Code 14 |
|--------------------|-----------------|---|--------------------|---|-------------|-------------|-------------|-------------|-------------|
| | N | D | N | D | | | | | |
| 15 | 0 | 0 | 0 | X | — | | — | — | — |
| 16 | 0 | 0 | X | 0 | — | | A | A or B NC | A |
| 17 | 0 | 0 | X | X | B | B | — | — | — |
| 18 | 0 | X | 0 | 0 | A | | — | — | B |
| 19 | 0 | X | 0 | X | — | A | B | — | — |
| 20 | 0 | X | X | 0 | — | — | — | — | A |
| 21 | 0 | X | X | X | A | A | A | — | — |
| 22 | X | 0 | 0 | 0 | A | A | A | — | — |
| 23 | X | 0 | 0 | X | — | — | — | — | A |
| 24 | X | 0 | X | 0 | — | A | B | — | — |
| 25 | X | 0 | X | X | A | A | — | — | B |
| 26 | X | X | 0 | 0 | B | B | — | — | — |
| 27 | X | X | 0 | 0 | — | | A | A or B NO | A |
| 28 | X | X | X | 0 | — | | — | — | — |

Series and Parallel Connections

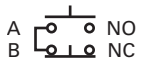

Series Connection



Parallel Connection

The connections are not made at the factory. They are illustrated in the selection table as requirements, but must be made on the job.

Note

① N = Button in free or normal position. D = Button depressed.

Circuit Location

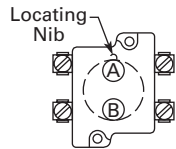

Letters “A” and “B” represent the locations which the two circuits of a contact block will occupy in relation to the locating nib of the operator.

Cam and Contact Block Selection for Three-Position Roto-Push

| Combination Number | Collar Position | | | | | | Cam Code 7 | Cam Code 8 | Cam Code 9 | Cam Code 15 ^② | Cam Code 16 | Cam Code 17 | Cam Code 18 |
|--------------------|-------------------------------|---|---|---|---|---|------------|------------|------------|--------------------------|-------------|-------------|-------------|
| | Circuit Sequence ^① | | | | | | | | | | | | |
| | N | D | N | D | N | D | | | | | | | |
| 1 | 0 | 0 | 0 | 0 | 0 | X | | | — | | | — | |
| 2 | 0 | 0 | 0 | 0 | X | X | — | — | | — | — | | — |
| 3 | 0 | 0 | 0 | X | 0 | 0 | — | — | | — | — | — | |
| 4 | 0 | 0 | 0 | X | 0 | X | — | — | — | — | — | — | |
| 5 | 0 | 0 | 0 | X | X | X | — | — | | — | — | — | — |
| 6 | 0 | 0 | X | X | 0 | 0 | — | | — | — | — | — | — |
| 7 | 0 | 0 | X | X | 0 | X | — | | — | — | — | — | — |
| 8 | 0 | 0 | X | X | X | 0 | | — | — | — | — | — | — |
| 9 | 0 | 0 | X | X | X | X | | — | — | — | — | — | — |
| 10 | 0 | X | 0 | 0 | 0 | 0 | | | — | | | | |
| 11 | 0 | X | 0 | 0 | 0 | X | | — | — | | | — | — |
| 12 | 0 | X | 0 | 0 | X | X | — | — | — | — | — | | — |
| 13 | 0 | X | 0 | X | 0 | 0 | — | — | — | — | — | — | |
| 14 | 0 | X | 0 | X | 0 | X | — | — | — | — | — | — | |
| 15 | 0 | X | X | X | 0 | 0 | — | | — | — | — | — | — |
| 16 | 0 | X | X | X | 0 | X | — | | — | — | — | — | — |
| 17 | 0 | X | X | X | X | X | | — | — | — | — | — | — |

Series and Parallel Connections

Series Connection

Parallel Connection

The connections are not made at the factory. They are illustrated in the selection table as requirements, but must be made on the job.

Circuit Location

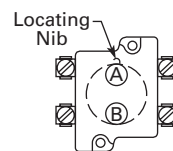

Letters "A" and "B" represent the locations which the two circuits of a contact block will occupy in relation to the locating nib of the operator.

Notes

- ① N = Button in free or normal position. D = Button depressed.
- ② Limited to 4 contact blocks. See Note on **Page V7-T1-266**.

Cam and Contact Block Selection for Three-Position Roto-Push, continued

| Combination Number | Circuit Sequence ^① | | | | | | Cam Code 7 | Cam Code 8 ^② | Cam Code 9 | Cam Code 15 | Cam Code 16 | Cam Code 17 | Cam Code 18 |
|--------------------|-------------------------------|---|---|---|---|---|------------|-------------------------|------------|-------------|-------------|-------------|-------------|
| | N | D | N | D | N | D | | | | | | | |
| 18 | X | 0 | 0 | 0 | 0 | 0 | | — | — | — | — | — | — |
| 19 | X | 0 | 0 | 0 | X | X | — | A | — | — | — | — | — |
| 20 | X | 0 | 0 | 0 | X | 0 | — | A | — | — | — | — | — |
| 21 | X | 0 | X | X | 0 | 0 | — | — | — | — | — | A | — |
| 22 | X | 0 | X | X | X | X | | A | — | — | A | B | A |
| 23 | X | 0 | X | X | X | 0 | A | — | — | — | A | — | — |
| 24 | X | 0 | X | 0 | X | 0 | — | — | — | A | — | — | A |
| 25 | X | 0 | X | 0 | X | X | — | — | — | A | — | — | A |
| 26 | X | X | 0 | 0 | 0 | 0 | B | — | A | — | — | — | — |
| 27 | X | X | 0 | 0 | 0 | X | | — | — | — | — | — | — |
| 28 | X | X | 0 | 0 | X | 0 | — | B | — | — | — | — | — |
| 29 | X | X | 0 | 0 | X | X | — | A | B | — | — | — | — |
| 30 | X | X | X | X | 0 | 0 | — | — | B | — | — | A | — |
| 31 | X | X | X | X | X | 0 | A | B | — | — | B | — | A |
| 32 | X | X | X | 0 | X | 0 | — | — | — | B | — | — | B |
| 33 | X | X | X | 0 | X | X | — | — | — | A | — | — | A |

Series and Parallel Connections

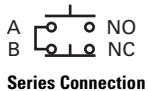

The connections are not made at the factory. They are illustrated in the selection table as requirements, but must be made on the job.

Circuit Location

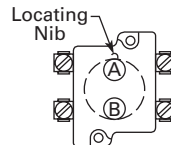

Letters "A" and "B" represent the locations which the two circuits of a contact block will occupy in relation to the locating nib of the operator.







Notes

- ① N = Button in free or normal position. D = Button depressed.
- ② Limited to 4 contact blocks. See Note on **Page V7-T1-266**.

Accessories

Padlocks not included with padlocking attachments. For operators with built-in padlock attachment, see **Page V7-T1-220**.

Accessories

| | Description | Catalog Number |
|---|---|----------------|
| Padlock Attachments | | |
|  | 10250TA2 Padlocking Attachment for Flush Pushbutton Operators Permits locking NC contacts in open position with 1/4 in padlock. Will not lock NO contact. | 10250TA2 |
|  | 10250TA26 Padlocking Attachment for Use with Extended Pushbutton Permits locking NC contacts in open position with 1/4 in padlock. | 10250TA26 |
|  | 10250TA36 Padlocking Cover Guard Cover locked over flush button makes it inaccessible or on extended button locks NC contacts open. Takes 1/4 in shank size padlock. | 10250TA36 |
|  | 10250TA38 Padlock Hasp or Flip-Up Guard When used with a 1/4 in padlock, makes flush and long button and knob selector switch inaccessible, but not locked down. Without the padlock, it is a flip-up guard. Padlock hasp can be removed before assembly. | 10250TA38 |
|  | 10250TA63 Padlocking Attachment for Use with Flexible Weather Resistant Boot Used on long button operators. Stainless steel. Use only for locking NC contacts open. | 10250TA63 |
|  | 10250TA64 Padlock Attachment For use with illuminated pushbuttons and maintained push-pull operators having standard button or lens only. Use 1/4 in padlock. Locks in down position only. | 10250TA64 |
|  | 10250TA11 Padlocking Attachment for Non-Illuminated Knob Selector Switches Provision for up to 5, 1/4 in padlocks. | 10250TA11 |







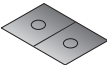

Accessories, continued

| | Description | Catalog Number |
|--|---|--------------------|
| Shrouds and Guards | | |
| 10250TA6  | Shroud for Mushroom Head Operator Prevents accidental operation. (Not for push-pull operators.) | 10250TA6 |
| 10250TA12  | Extended Retaining Nut Replaces standard nut and provides guard for flush head pushbutton operators. | 10250TA12 |
| 10250TA15  | Guard for Illuminated Pushbutton | 10250TA15 |
| 10250TA56_  | Shroud For jumbo mushroom head operator. Gray | 10250TA56 |
| | Yellow | 10250TA56Y |
| 10250ED1241  | Half Shroud —Yellow For jumbo mushroom head operator. | 10250ED1241 |
| 10250TA101  | Fingerproof Shroud —10 per package Fits new style contact blocks and light units. | 10250TA101 |
| Boots | | |
| 10250TA_  | Flexible Weather Resistant Boot For use with button operators (extended buttons preferred). Temperature to –25°F (–32°C). (See Page V7-T1-259 for 10250TA96 Tightening Tool.) Black | 10250TA3 |
| | Red | 10250TA4 ① |
| | Green | 10250TA10 |
| 10250TA25  | Transparent Boot For regular illuminated pushbutton operators and PresTest— Temperature to –38°F (–39°C). ② | 10250TA25 |
| 10250TA4_  | Boot for Flush Pushbutton Clear | 10250TA46 |
| | Black | 10250TA47 |
| | Red | 10250TA48 |
| | Green | 10250TA49 |

Notes

- ① Should not be used on flush button for STOP function.
- ② Not suitable for single contact block depth cast enclosure. Cover is too thick.

Accessories, continued

| | Description | Catalog Number |
|---|---|--------------------|
| Hardware and Kits | | |
| 10250TK3  | Thrust Washers — To meet Ford Motor Co. mounting specifications. | 10250TK3 |
| 10250TK5  | Contact Block Tape Seal — Seals plunger openings on last contact block. Order in multiples of 10 pieces. | 10250TK5 |
| 56-9337  | Selector Switch Operator Gasket — Seals out dust from getting in-between the cam and contact block plungers. Supplied as standard with all selector switches. | 56-9337 |
| 10250TA3  | Special Retaining Nut — To accommodate thick panel: Indicating lights | 10250TA30 |
| | PresTest, pushbuttons and selector switches | 10250TA31 |
| 10250TA62  | Terminal Block — Two terminals, each will accommodate two wire terminations. | 10250TA62 |
| 10250TA8  | Spacer Ring — Used when legend plate is not required. | 10250TA8 |
| 10250TA79  | Stacking Screw — Replaces transformer mounting screws on indicating light so terminal block 10250TA62 can be mounted to light to support and connect a series resistor. This screw also fits all contact blocks. Order in multiples of 10. | 10250TA79 |
| 10250TA2  | Base Mounting Spacers ①— Equivalent to contact block in depth (one block deep). | 10250TA22 |
| | Complete with screws, washers, etc. (two block deep). | 10250TA23 |
| 10250TKG  | Grounding Kits — Kits consist of a ring connector and a #6 screw for mounting connector to rear of contact block mounting screw. All components except standard indicating lights and PresTest indicating lights. | 10250TKG1 |
| | Standard indicating lights | 10250TKG2 ② |
| | PresTest indicating lights | 10250TKG3 ② |
| 10250TA7  | Contact Block Terminal Jumpers — Available in multiples of 100 only. Terminal to terminal—within block (short) | |
| | 100 per pkg. | 10250TA70 |
| | 1000 per pkg. | 10250TA70-2 |
| | Terminal to terminal—block to block (long) | |
| | 100 per pkg. | 10250TA71 |
| | 1000 per pkg. | 10250TA71-2 |

Notes

- ① Component only. Not to be used for custom built (factory assembled) stations.
- ② Not suitable for single contact block depth cast enclosure. Cover is too thick.









Accessories, continued

| | Description | Catalog Number |
|---|--|---------------------|
| Special Operators and Attachments | | |
|  | 10250TA5 Wobble Stick Complete with retaining nut—fits standard button. | 10250TA5 |
|  | 10250TA14 Lever Operator For use with two vertically mounted flush pushbuttons. | 10250TA14 |
|  | 10250TA Maintained Contact Attachment Release Button Assembly ^① Mechanically interlocks with another pushbutton and contact block (not included). Provides mode indication. Minimum hole centers 1.62 in (41.1 mm), maximum 2.313 in (58.8 mm). | |
| | Black | 10250TA17 |
| | Red | 10250TA18 |
| | Green | 10250TA19 |
| | Yellow | 10250TA20 |
| | Same with Long Button—Black | 10250TA39 |
|  | 10250TA1 Maintained Contact Attachment ^① Mechanically interlocks two buttons and provides position indication for one. Use with two pushbutton operators and one or more contact blocks. | 10250TA1 |
|  | 10250TA13 Roto-Push Lever Operator — Used to provide lever operation for Roto-Push operators. | 10250TA13 |
| Special Light Modules | | |
|  | 10250TA79 Master Test (Dual Input) Module — Internal Form C relay suitable for either AC or DC applications. Total electrical isolation between monitored and test circuit. Fits all illuminated 10250T, E22, E30 and E34 devices. | |
| | 48 Vdc | 10250TMT8 |
|  | 10250TFL Flasher Module — Changes any AC illuminated device to a controlled flashing light. Fits 10250T, E30 and E34 devices. | |
| | 24V | 10250TFL2 |
| | 120V | 10250TFL1 |
|  | 10250ED986-4 Flashing Incandescent Lamp — For use with 120V transformer type or 6V full voltage type indicating lights including PresTest and most E29 devices. | 10250ED986-4 |

Note

^① Not suitable for single contact block depth cast enclosure. Cover is too thick.

Accessories, continued

| Description | Catalog Number |
|---|-------------------|
| Hole Plugs | |
| 10250TA7 | 10250TA7 |
|  <p>Plug— For unused holes—steel, painted gray (stainless steel, use E30KT5, see Page V7-T1-206)</p> | |
| Tools | |
| 10250TA95 | 10250TA95 |
|  <p>Octagonal 10250T (notched to fit over selector switch lever), E29 and E30</p> | |
| E22CW | E22CW |
|  <p>E22, E30, E34 and octagonal 10250T (will not fit over selector switch levers)</p> | |
| 10250TA96 | 10250TA96 |
|  <p>Tool for Tightening Boots— Used to install boot Catalog Numbers 10250TA3, A4, A10 and A25.</p> | |
| 10250TA102 | 10250TA102 |
|  <p>10250T, E34 Allen Wrench— Used for removal of jumbo mushroom head.</p> | |
| 10250TA74 | 10250TA74 |
|  <p>Lamp Removal Tools— For transformer type illuminated pushbuttons, push-pull and selector switches. Fits #12 lamp.</p> | |
| E30KV1 | E30KV1 |
|  <p>For full voltage and resistor type illuminated pushbuttons, push-pull and selector switches and E30.</p> | |
| E29KLT | E29KLT |
|  <p>Standard indicating lights. Fits #44, #755, #6S6 and #10S6.</p> | |

1

Options

Legend Plates

Legend Plates with Standard Markings

The legend plates listed below are sized for all standard commercial enclosures and Eaton’s cast enclosures. For vertical

spacing less than 1.75 in, replace the **S** in the catalog number with **MS**, or the **M** with **P** (except push-pull). No change in price. The smaller

size legend plates, “MS” or “P” size, have limited space for legend.

Square Legend Plate



1/2 Round Legend Plate



For Pushbutton Operators and Indicating Lights—Standard

| Legend | Color of Field | Square ① Catalog Number | 1/2 Round Catalog Number | Legend | Color of Field | Square ① Catalog Number | 1/2 Round Catalog Number |
|--|----------------|----------------------------|-----------------------------|----------|----------------|----------------------------|-----------------------------|
| Blank—see table on Page V7-T1-262. | | | | | | | |
| Letters on Legend Plates Below are 3/16 in High | | | | | | | |
| CLAMP | Black | 10250TS90 | 10250TM90 | OFF | Red | 10250TS24 | 10250TM24 |
| CLOSE | | 10250TS73 | 10250TM11 | ON | Black | 10250TS25 | 10250TM25 |
| DOWN | | 10250TS74 | 10250TM12 | OPEN | | 10250TS26 | 10250TM26 |
| EMERG. STOP | Red | 10250TS13 | 10250TM13 | OUT | | 10250TS27 | 10250TM27 |
| FAST | Black | 10250TS75 | 10250TM14 | POWER ON | | 10250TS80 | 10250TM80 |
| FASTER | | 10250TS87 | 10250TM87 | RAISE | | 10250TS28 | 10250TM28 |
| FEEDER ON | | 10250TS94 | 10250TM94 | READY | | 10250TS86 | 10250TM86 |
| FEEDER OFF | | 10250TS95 | 10250TM95 | RESET | | 10250TS29 | 10250TM29 |
| FORWARD | | 10250TS15 | 10250TM15 | REVERSE | | 10250TS30 | 10250TM30 |
| HIGH | | 10250TS16 | 10250TM16 | RUN | | 10250TS31 | 10250TM31 |
| IN | | 10250TS17 | 10250TM17 | SAFE | | 10250TS85 | 10250TM85 |
| INCH | | 10250TS18 | 10250TM18 | SLOW | | 10250TS32 | 10250TM32 |
| JOG | | 10250TS19 | 10250TM19 | SLOWER | | 10250TS88 | 10250TM88 |
| JOG FOR. | | 10250TS20 | 10250TM20 | START | | 10250TS33 | 10250TM33 |
| JOG REV. | | 10250TS21 | 10250TM21 | STOP | Red | 10250TS34 | 10250TM34 |
| LOW | | 10250TS22 | 10250TM22 | TEST | Black | 10250TS83 | 10250TM83 |
| LOWER | | 10250TS23 | 10250TM23 | TRANSFER | | 10250TS93 | 10250TM93 |
| LUBE-FAIL | | 10250TS92 | 10250TM92 | TRIP | | 10250TS84 | 10250TM84 |
| MOTOR RUN | | 10250TS81 | 10250TM81 | UNCLAMP | | 10250TS91 | 10250TM91 |
| MOTOR STOP | | 10250TS82 | 10250TM82 | UP | | 10250TS35 | 10250TM35 |

Blank Plastic Legend Plates—Square

| Color Lettering | Field | Standard Catalog Number | Jumbo ② Catalog Number | Extra Large Catalog Number |
|-----------------|-------------------|-------------------------|---------------------------|----------------------------|
| Black | White or silver ③ | 10250TSP76 | 10250TLP76 | 10250TEP76 |
| White | Red or black ③ | 10250TSP77 | 10250TLP77 | 10250TEP77 |

Notes

- ① Square legend plates have a satin aluminum field. Color is on lower portion.
- ② Cannot be used on cast enclosures except for top row. Suitable for most sheet metal enclosures.
- ③ If legend plate is to be engraved, specify field color required.

Square Legend Plate



1/2 Round Legend Plate



For Selector Switch and Roto-Push Operators—Standard Size

| Legend | Color of Field | Square ^① Catalog Number | 1/2 Round Catalog Number | Legend | Color of Field | Square ^① Catalog Number | 1/2 Round Catalog Number |
|---|----------------|---------------------------------------|-----------------------------|---|----------------|---------------------------------------|-----------------------------|
| Blank—see table on Page V7-T1-262. | | | | | | | |
| 2-Position—5/32 in High Lettering | | | | 3-Position—1/8 in High Lettering | | | |
| FOR. REV. | Black | 10250TS38 | 10250TM38 | AUTO OFF HAND | Black | 10250TS49 | 10250TM49 |
| HAND AUTO | | 10250TS39 | 10250TM39 | FOR. OFF REV. | | 10250TS50 | 10250TM50 |
| HIGH LOW | | 10250TS40 | 10250TM40 | FOR. SAFE REV. | | 10250TS69 | 10250TM69 |
| JOG RUN | | 10250TS41 | 10250TM41 | HAND OFF AUTO | | 10250TS51 | 10250TM51 |
| MAN. AUTO | | 10250TS67 | 10250TM67 | MAN. OFF AUTO | | 10250TS68 | 10250TM68 |
| OFF ON | | 10250TS42 | 10250TM42 | OPEN OFF CLOSE | | 10250TS53 | 10250TM53 |
| OPEN CLOSE | | 10250TS43 | 10250TM43 | RUN SAFE JOG | | 10250TS70 | 10250TM70 |
| RUN JOG | | 10250TS44 | 10250TM44 | UP OFF DOWN | | 10250TS54 | 10250TM54 |
| SAFE RUN | | 10250TS45 | 10250TM45 | ON STOP SAFE | Red | 10250TS71 | 10250TM71 |
| START JOG | | 10250TS46 | 10250TM46 | | | | |
| START STOP | | 10250TS47 | 10250TM47 | | | | |
| UP DOWN | | 10250TS48 | 10250TM48 | | | | |

70 mm Round—Plastic Legend Plate



45 mm and 70 mm Plastic—Round

| Color | Lettering | Field | Catalog Number |
|--------------|-------------|----------------------------|----------------|
| 45 mm | | | |
| Blank | | Yellow or red ^② | 10250TRP78 |
| 70 mm | | | |
| Blank | | Yellow or red ^② | 10250TRP76 |
| Red | EMERG. STOP | Yellow | 10250TRP79 |

For Push-Pull Units ^③

| Legend | Color of Field | Square ^① Catalog Number | 1/2 Round Catalog Number |
|--|----------------|---------------------------------------|-----------------------------|
| Standard Size—Letters on Legend Plates Below are 3/32 in High | | | |
| PULL START/PUSH STOP | Green/red | 10250TPP2 | 10250TR2 |
| PUSH ON/PULL OFF | Black | 10250TPP5 | 10250TR5 |
| PULL OPEN/PUSH CLOSE | Black | 10250TPP8 | 10250TR8 |
| PULL UP/PUSH DOWN | Black | 10250TPP11 | 10250TR11 |
| Jumbo Size—Letters on Legend Plates Below are 1/8 in High | | | |
| PULL START/PUSH STOP | Green/red | 10250TPP3 | 10250TR3 |
| PULL ON/PUSH OFF | Black | 10250TPP6 | 10250TR6 |
| PULL OPEN/PUSH CLOSE | Black | 10250TPP9 | 10250TR9 |
| PULL UP/PUSH DOWN | Black | 10250TPP12 | 10250TR12 |

Notes

- ① Square legend plates have a satin aluminum field. Color is on lower portion.
- ② If legend plate is to be engraved, specify field color required.
- ③ All push-pull legend plates include the symbols ≠ ∅ in the center of the plate.

Legend Plates with Non-Standard Markings

When Ordering Specify

- Catalog number of blank plate phase plus Suffix “STAMP”
- Insert the following into Order Notes: legend, letter size and locations (letters A–W)—combine letters for definitive locations as shown.

Ordering Example:

Catalog No.: **10250TS36STAMP**
 Letter Size: 3/32 in (2.4 mm)
 Pos. A—POWER HOUSE
 Pos. B—START PUMP 1

Legend Characters Available

A B C D E F G H I J K L M N O
 P Q R S T U V W X Y Z / - . , 1
 2 3 4 5 6 7 8 9 0

Legend characters on black and red plates are white—on satin aluminum plates, characters are black.

Blackening Kit

Solution blackens aluminum exposed by engraving process. Must be applied immediately after engraving. 0.3 oz. bottle—sufficient for approximately 1100 legend plates.

Catalog Number: **10250TBK**

Legend Positions

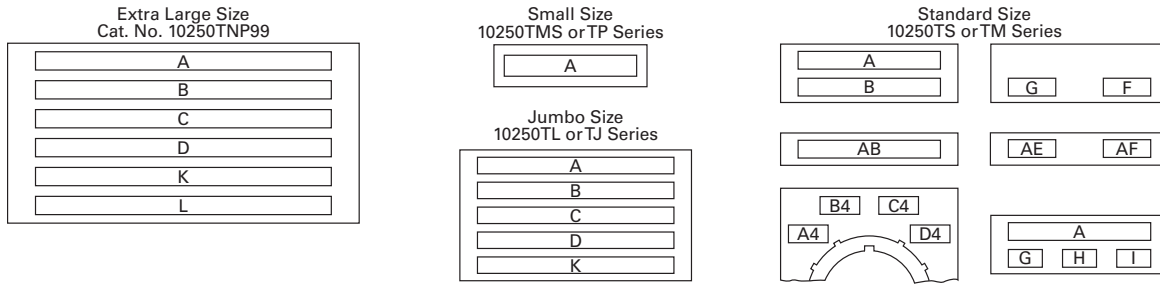

Blank and Custom Engraved Legend Plates

| Style | Color | Small Catalog Number | Standard Catalog Number | Jumbo ^② Catalog Number | Extra Large ^③ Catalog Number | Four-Position Selector Switch | | Push-Pull with Symbols ^① | |
|---------------------|-------------|----------------------|-------------------------|-----------------------------------|---|------------------------------------|-------------------------|-------------------------------------|-----------------------------------|
| | | | | | | Custom ^④ Catalog Number | Standard Catalog Number | Standard Catalog Number | Jumbo ^② Catalog Number |
| Square ^⑤ | Black | 10250TMS36 | 10250TS36 | 10250TL36 | — | 10250TS76 | 10250TS72 | 10250PPP17 | 10250PPP18 |
| | Red | 10250TMS37 | 10250TS37 | 10250TL37 | — | — | — | — | — |
| | Green/red | — | — | — | — | — | — | 10250PPP20 | 10250PPP21 |
| | Satin alum. | — | — | — | 10250TNP99 | — | — | — | — |
| 1/2 Round | Black | 10250TP36 | 10250TM36 | 10250TJ36 | — | — | 10250TM72 | 10250TR17 | 10250TR18 |
| | Red | 10250TP37 | 10250TM37 | 10250TJ37 | — | — | — | — | — |
| | Green/red | — | — | — | — | — | — | 10250TR20 | 10250TR21 |
| | Satin alum. | — | 10250TM89 | 10250TJ89 | — | — | — | — | — |

Maximum Characters per Legend Plate and Approximate Dimensions

| Top (Aluminum and Plastic) | Approximate Dimensions in Inches (mm) | | Style | Character Size 3/32 in High | | 1/8 in High | | 3/16 in High | |
|----------------------------|---------------------------------------|-------------|-----------|-----------------------------|----------------------|-----------------|----------------------|-----------------|----------------------|
| | Width | Height | | Number of Lines | Number of Characters | Number of Lines | Number of Characters | Number of Lines | Number of Characters |
| Small ^⑥ | 1.59 (40.4) | 1.59 (40.4) | Square | 1 | 17 | — | — | — | — |
| | | | 1/2 Round | 1 | 15 | 1 | 12 | 1 | 9 |
| Standard and custom | 1.75 (44.5) | 1.75 (44.5) | Square | 2 | 18 | 2 | 13 | 1 | 9 |
| | | | 1/2 Round | 2 | 15 | 2 | 12 | 1 | 9 |
| Jumbo ^⑦ | 2.19 (55.6) | 2.19 (55.6) | Square | 5 | 23 | 3 | 18 | 2 | 12 |
| | | | 1/2 Round | 5 | 19 | 4 | 15 | 2 | 11 |
| Extra large ^⑧ | 2.44 (62.0) | 2.44 (62.0) | Square | 6 | 25 | 3 | 18 | 3 | 12 |



Notes

- ^① All push-pull legend plates include the symbols ≠ ∅ in the center of the plate.
- ^② Cannot be used on cast enclosures except for top row. Suitable for most sheet metal enclosures.
- ^③ When used to meet Ford Motor Co. specifications, specify engraved legend. Cannot be used on standard cast or sheet metal enclosures.
- ^④ Slightly larger than standard size for legends requiring more space—fits cast enclosures.
- ^⑤ Square legend plates have a satin aluminum field. Color is on lower portion.
- ^⑥ Recommended only when mounting on minimum centers (less than 1-3/4 in [44.5 mm] vertical centers).
- ^⑦ Can be used on top row only of any enclosure.

Enclosures

Die Cast, Polyester and Stainless Steel Enclosures

Enclosures (Case and Cover)—Surface Mounting ^①

| | Number of Elements | One Contact Block Depth Catalog Number | Two Contact Block Depth Catalog Number |
|--|---|--|--|
| Die Cast Enclosure | Die Cast Enclosure—In-Line ^{②③④} NEMA 4, 4X, 12, 13 | | |
|  | 1 | 10250TN1 | 10250TN11 |
| | 2 | 10250TN2 | 10250TN12 |
| | 3 | 10250TN3 | 10250TN13 |
| | 4 | — | 10250TN14 |
| Polyester Enclosure | Polyester ^④—In-Line NEMA 3, 4X, 12 | | |
|  | 1 | — | E34N51 |
| | 2 | — | E34N52 |
| | 3 | — | E34N53 |
| | 4 | — | E34N54 |
| Stainless Steel Enclosure | Stainless Steel ^{④⑤}—In-Line NEMA 4, 4X, 12 | | |
|  | 1 | — | 10250TN33 |
| | 2 | — | 10250TN34 |
| | 3 | — | 10250TN35 |
| | 4 | — | 10250TN36 |

Dimensions, see Page V7-T1-276.

Mounting Instructions

Two-position joystick must be used with two contact block deep enclosures (maximum number of contact blocks = 1). Four-position joysticks cannot be used within these enclosures.

One and Two Contact Block Depth Enclosures



Enclosure Layouts

Top – For Vertical Mounting

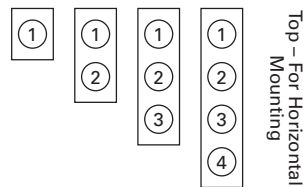

Notes

- ① For spacing increments, see Page V7-T1-264.
- ② All die cast enclosures can be converted to base mounting of contact blocks, with spacers 10250TA22 or 10250TA23. See listing on Page V7-T1-257.
- ③ When used with E30 pushbuttons, only the one element enclosure can be used.
- ④ When used with resistor light units, only the 2 contact block depth enclosure can be used.
- ⑤ 14 gauge, type 304.

Die Cast and Stainless Steel—Flush Mount, Covers Only

Flush Mounting Covers



Covers Only—Flush Mounting

| Number of Elements | Catalog Number | Catalog Number |
|---|---------------------------|---------------------------|
| Flush Die Cast Covers | | |
| | In-Line Deep Cover | In-Line Flat Cover |
| 1 | 10250TF11 | 10250TF1 |
| 2 | 10250TF12 | 10250TF2 |
| 3 | 10250TF13 | 10250TF3 |
| 4 | 10250TF14 | 10250TF4 |
| In-Line Stainless Steel Flush Plates ① | | |
| | With Pullbox | Without Pullbox |
| 1 | 10250TS10 | 10250TS1 |
| 2 | 10250TS11 | 10250TS2 |
| 3 | 10250TS12 | 10250TS3 |
| 4 | 10250TS14 | 10250TS4 |
| Dimensions, see Page V7-T1-277. | | |

Spacing Increments

Approximate Dimensions in Inches (mm)

| Type | F | G | H |
|-----------------|-------------|------------------|-------------|
| Die cast | 2.44 (62.0) | 2.5 (63.5) | 1.88 (47.8) |
| Polyester | 1.88 (47.8) | Min. 2.13 (54.1) | 2.25 (57.2) |
| Stainless steel | 1.69 (42.9) | Min. 1.73 (43.9) | 2.25 (57.2) |

Spacing Increments for Enclosures

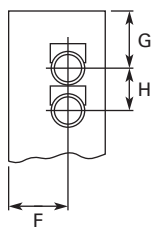

Enclosure Layouts

Top – For Vertical Mounting

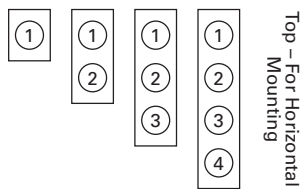

Note

① Not oiltight. NEMA 1 applications only.

Contact Blocks

Standard Contact Blocks

- UL A600/P600 rated
- Color-coded plungers—red/green for NC/NO circuits
- Silver contact tips with “reliability nibs”
- Gray (opaque) or amber (translucent) housings
- Pressure plate or spade terminals
- Fingerproof shrouds (for pressure terminals only)

Logic Level Contact Blocks

- UL A600/P600 rated
- Color-coded plungers
- Inert palladium knife-blade contacts
- Gray (opaque) housings
- Pressure plate or spade terminals

Special Function Contact Blocks

- UL A600/P600 rated
- Color-coded plungers
- Silver contact tips with “reliability nibs”
- Gray (opaque) housings
- Pressure plate terminals only

Special Purpose Contact Block

- Maximum 300V rated
- Black plungers
- Silver contact tips with “reliability nibs”
- Black (opaque) housings
- Pressure plate terminals only
- Fingerproof shrouds not available

Reliability Nibs

Reliability nibs are the hallmark of Eaton’s contact blocks. A pointed silver nib on the contact tip ensures reliable switching from logic level (5V) up to 600V applications. Therefore standard contact blocks can be used for most logic level applications where the contacts are not exposed to any harsh environmental conditions.

Palladium Contacts

Palladium, which is more inert than gold, is well suited for voltages and currents approaching zero and is recommended for applications where environmental conditions are a factor.

Maximum Contact Block Mounting per Operator Type

| Operator | Max. Stack |
|--|------------|
| Pushbuttons | 6 |
| Push-pull operators | 2 |
| Roto-push operators | 4 |
| Two- or three-position selector switches | 6 |
| Four-position selector switches | 4 |
| Joysticks | 4 |

10250T1



Contact Blocks

| Symbol | Circuit | Description ^① | Standard | Spade Terminal ^② | Logic Level | Spade Terminal ^② |
|---|-----------|--|----------------------------------|-----------------------------|----------------------------------|-----------------------------|
| | | | Pressure Terminal Catalog Number | Catalog Number | Pressure Terminal Catalog Number | Catalog Number |
| | 1NC | Stack up to six blocks (six circuits) unless otherwise noted. | 10250T51 | 10250T59 | 10250T51E | 10250T59E |
| | 1NO | Stack up to six blocks (six circuits) unless otherwise noted. | 10250T53 | 10250T60 | 10250T53E | 10250T60E |
| | NO-NC | Stack up to six blocks (12 circuits) unless otherwise noted. | 10250T1 | 10250T40 | 10250T1E | 10250T40E |
| | 2NC | Stack up to six blocks (12 circuits) unless otherwise noted. | 10250T3 | 10250T42 | 10250T3E | 10250T42E |
| | 2NO | Stack up to six blocks (12 circuits) unless otherwise noted. | 10250T2 | 10250T41 | 10250T2E | 10250T41E |
| Special Function Blocks ^③ | | | | | | |
| | LONC | Late opening NC. Stack up to six blocks (six circuits) unless otherwise noted. | 10250T71 ^③ | — | 10250T71E ^③ | — |
| | ECNO-NC | Early closing NO and standard NC. Stack up to six blocks unless otherwise noted. | 10250T47 ^{③④} | — | 10250T47E ^③ | — |
| | ECNO-NO | Early closing NO and standard NO. Stack up to four blocks unless otherwise noted. | 10250T57 ^{③④} | — | 10250T57E ^③ | — |
| | 2LONC | Two late opening NC contacts. Stack up to six blocks unless otherwise noted. | 10250T45 ^③ | — | 10250T45E ^③ | — |
| | LONC-ECNO | Overlapping contacts. Stack up to four blocks unless otherwise noted. | 10250T55 ^{③④} | — | 10250T55E ^③ | — |
| Special Purpose Blocks ^⑤ | | | | | | |
| | 2NO-2NC | Four circuits in single block depth. Rated 300V max. Stack up to four blocks unless otherwise noted. | 10250T44 ^⑤ | — | | |

Notes

- ① All 10250T contact blocks shown are suitable for use on standard 10250T and E34 operators. These contact blocks are not suitable for Class I Division 2 type 10250T or E34 devices.
- ② Contact blocks with spade terminals are limited to a maximum of one contact block per operator and minimum spacing between devices is 2.5 in (63.5 mm). Not suitable for use in 10250T or E34 enclosures. Also available in amber housing. Not available with fingerproof shrouds.
- ③ Special function contact blocks are not suitable for use with roto-push operators, three-position push-pull operators, or four-position selector switches.
- ④ ECNO contact blocks are not suitable for use with two-position joysticks or when operators are used with padlock attachments.
- ⑤ Special purpose 10250T44 contact blocks are not suitable on selector switches or roto-push operators. Okay to use with three-position push-pull operators only on low voltage (30V or less) circuits. Fingerproof shrouds not available.

10250T1CP



Contact Blocks with Fingerproof Shrouds

| Symbol | Circuit | Description ^① | Standard Pressure Terminal ^② Catalog Number | Logic Level Pressure Terminal ^② Catalog Number |
|---|-----------|---|--|---|
| Blank No Plunger | 1NC | Stack up to six blocks (six circuits) unless otherwise noted. | 10250T51P | 10250T51EP |
| Blank No Plunger | 1NO | Stack up to six blocks (six circuits) unless otherwise noted. | 10250T53P | 10250T53EP |
| Blank No Plunger | NO-NC | Stack up to six blocks (12 circuits) unless otherwise noted. | 10250T1P | 10250T1EP |
| Blank No Plunger | 2NC | Stack up to six blocks (12 circuits) unless otherwise noted. | 10250T3P | 10250T3EP |
| Blank No Plunger | 2NO | Stack up to six blocks (12 circuits) unless otherwise noted. | 10250T2P | 10250T2EP |
| Special Function Blocks ^③ | | | | |
| Blank No Plunger | LONC | Late opening NC. Stack up to six blocks (six circuits) unless otherwise noted. | 10250T71P ^④ | 10250T71EP ^④ |
| Blank No Plunger | ECNO-NC | Early closing NO and standard NC. Stack up to six blocks unless otherwise noted. | 10250T47P ^{③④} | 10250T47EP ^④ |
| Blank No Plunger | ECNO-NO | Early closing NO and standard NO. Stack up to four blocks unless otherwise noted. | 10250T57P ^{③④} | 10250T57EP ^④ |
| Blank No Plunger | 2LONC | Two late opening NC contacts. Stack up to six blocks unless otherwise noted. | 10250T45P ^④ | 10250T45EP ^④ |
| Blank No Plunger | LONC-ECNO | Overlapping contacts. Stack up to four blocks unless otherwise noted. | 10250T55P ^{③④} | 10250T55EP ^④ |

Notes

- ① All 10250T contact blocks shown are suitable for use on standard 10250T and E34 operators. These contact blocks are not suitable for Class I Division 2 type 10250T or E34 devices.
- ② To order contact blocks with translucent amber housing, change suffix P to **CP** in catalog number e.g. 10250T51**CP**.
- ③ ECNO contact blocks are not suitable for use with two-position joysticks or when operators are used with padlock attachments.
- ④ Special function contact blocks are not suitable for use with roto-push operators, three-position push-pull operators, or four-position selector switches.

10250T1C



Amber Contact Blocks

| Symbol | Circuit | Description ^① | Standard | Spade Terminal | Logic Level | Spade Terminal |
|---|--------------------------|---|--|-----------------------------|--|-----------------------------|
| | | | Pressure Terminal ^② Catalog Number | Catalog Number ^③ | Pressure Terminal ^② Catalog Number | Catalog Number ^③ |
| | Blank No Plunger 1NC | Stack up to six blocks (six circuits) unless otherwise noted. | 10250T51C | 10250T59C | 10250T51EC | 10250T59EC |
| | Blank No Plunger 1NO | Stack up to six blocks (six circuits) unless otherwise noted. | 10250T53C | 10250T60C | 10250T53EC | 10250T60EC |
| | NO-NC | Stack up to six blocks (12 circuits) unless otherwise noted. | 10250T1C | 10250T40C | 10250T1EC | 10250T40EC |
| | 2NC | Stack up to six blocks (12 circuits) unless otherwise noted. | 10250T3C | 10250T42C | 10250T3EC | 10250T42EC |
| | 2NO | Stack up to six blocks (12 circuits) unless otherwise noted. | 10250T2C | 10250T41C | 10250T2EC | 10250T41EC |
| Special Function Blocks ^③ | | | | | | |
| | Blank No Plunger LONC | Late opening NC. Stack up to six blocks (six circuits) unless otherwise noted. | 10250T71C ^④ | — | 10250T71EC ^④ | — |
| | ECNO-NC | Early closing NO and standard NC. Stack up to six blocks unless otherwise noted. | 10250T47C ^{④⑤} | — | 10250T47EC ^④ | — |
| | ECNO-NO | Early closing NO and standard NO. Stack up to four blocks unless otherwise noted. | 10250T57C ^{④⑤} | — | 10250T57EC ^④ | — |
| | 2LONC | Two late opening NC contacts. Stack up to six blocks unless otherwise noted. | 10250T45C ^④ | — | 10250T45EC ^④ | — |
| | LONC-ECNO | Overlapping contacts. Stack up to four blocks unless otherwise noted. | 10250T55C ^{④⑤} | — | 10250T55EC ^④ | — |

Notes

- ① All 10250T contact blocks shown are suitable for use on standard 10250T and E34 operators. These contact blocks are not suitable for Class I Division 2 type 10250T or E34 devices.
- ② To order amber contact blocks with fingerproof shrouds, change suffix to **CP** in the catalog number e.g. 10250T51**CP**. Not available with spade terminals.
- ③ Contact blocks with spade terminals are limited to a maximum of one contact block per operator and minimum spacing between devices is 2.5 in (63.5 mm). Not suitable for use in 10250T or E34 enclosures. Also available in amber housing. Not available with fingerproof shrouds.
- ④ Special function contact blocks are not suitable for use with roto-push operators, three-position push-pull operators, or four-position selector switches.
- ⑤ ECNO contact blocks are not suitable for use with two-position joysticks or when operators are used with padlock attachments.

Replacement Parts

Replacement Lamps—For 10250T Illuminated Operators

| Mfg. Lamp Type | Voltage | Base Style | Application | Part Number |
|----------------|---------|-----------------|---|---------------------|
| 120MB | 120V | T 3-1/4 bayonet | 10250T resistor indicating light | 28-3044 |
| #267 | 6.3V | T 3-1/4 bayonet | 10250T flasher | 10250ED986-4 |
| #755 | 6.3V | T 3-1/4 bayonet | 10250T transformer, PresTest and full voltage | 28-2202 |
| #756 | 12V | T 3-1/4 bayonet | 10250T full voltage | 28-5184 |
| #757 | 24V | T 3-1/4 bayonet | 10250T full voltage | 28-5185 |
| #1828 | 32V | T 3-1/4 bayonet | 10250T full voltage | 28-5186 |
| #1835 | 55V | T 3-1/4 bayonet | 10250T resistor | 28-5187 |
| NE48 | 120V | T 4-1/2 bayonet | 10250T neon | 28-494 |
| NE51H-R22 | 120V | T 3-1/4 bayonet | 10250T neon | 28-3754 |
| NE51H-R68 | 240V | T 3-1/4 bayonet | 10250T neon | 28-3755 |

Standard LED Lamp



Replacement LED Lamps—For 10250T, E34 and E22 Units

| Voltage | Color | Continuous AC/DC Catalog Number | Flashing AC Catalog Number | DC Catalog Number |
|---------|--------|---------------------------------|----------------------------|---------------------|
| 6–12V | Red | E22LED612RN | E22LED006RAF | E22LED006RDF |
| | Orange | E22LED612ON | E22LED006OAF | E22LED006ODF |
| | Yellow | E22LED612YN | E22LED006YAF | E22LED006YDF |
| | Green | E22LED612GN | E22LED006GAF | E22LED006GDF |
| | Blue | E22LED612BN | E22LED006BAF | E22LED006BDF |
| | White | E22LED612WN | E22LED006WAF | E22LED006WDF |
| 24V | Red | E22LED024RN | E22LED024RAF | E22LED024RDF |
| | Orange | E22LED024ON | E22LED024OAF | E22LED024ODF |
| | Yellow | E22LED024YN | E22LED024YAF | E22LED024YDF |
| | Green | E22LED024GN | E22LED024GAF | E22LED024GDF |
| | Blue | E22LED024BN | E22LED024BAF | E22LED024BDF |
| | White | E22LED024WN | E22LED024WAF | E22LED024WDF |
| 48V | Red | E22LED048RN | E22LED048RAF | E22LED048RDF |
| | Orange | E22LED048ON | E22LED048OAF | E22LED048ODF |
| | Yellow | E22LED048YN | E22LED048YAF | E22LED048YDF |
| | Green | E22LED048GN | E22LED048GAF | E22LED048GDF |
| | Blue | E22LED048BN | E22LED048BAF | E22LED048BDF |
| | White | E22LED048WN | E22LED048WAF | E22LED048WDF |
| 60V | Red | E22LED060RN | E22LED060RAF | E22LED060RDF |
| | Orange | E22LED060ON | E22LED060OAF | E22LED060ODF |
| | Yellow | E22LED060YN | E22LED060YAF | E22LED060YDF |
| | Green | E22LED060GN | E22LED060GAF | E22LED060GDF |
| | Blue | E22LED060BN | E22LED060BAF | E22LED060BDF |
| | White | E22LED060WN | E22LED060WAF | E22LED060WDF |
| 120V | Red | E22LED120RN | E22LED120RAF | E22LED120RDF |
| | Orange | E22LED120ON | E22LED120OAF | E22LED120ODF |
| | Yellow | E22LED120YN | E22LED120YAF | E22LED120YDF |
| | Green | E22LED120GN | E22LED120GAF | E22LED120GDF |
| | Blue | E22LED120BN | E22LED120BAF | E22LED120BDF |
| | White | E22LED120WN | E22LED120WAF | E22LED120WDF |

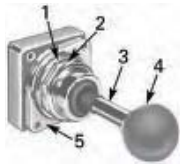

Two-Position Joystick Operator



Flush Head Pushbutton Operator



Mushroom Head Pushbutton Operator



Mushroom Head Operator with Padlock Attachment

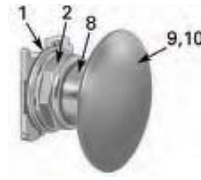

Jumbo Mushroom Head Operator



Knob-Operated Selector Switch Operator

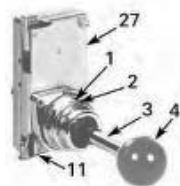

Four-Position Joystick Operator (without Latch)



Illuminated Pushbutton Operator



Full Voltage, Resistor and Transformer Type Illuminated Selector Switch

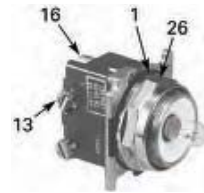

Transformer Type Indicating Light

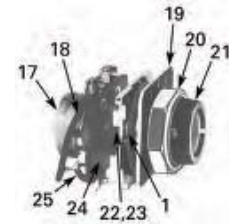

Potentiometers

10250T Style Operator Replacement Parts

| Item No. | Description | No. Req. | Part Number |
|----------|---|----------|----------------------|
| 1 | Gasket | 1 | 16-1548 |
| 2 | Mounting nut | 1 | 15-1530 |
| 3 | Handle | 1 | 24-5045 |
| 4 | Knob | 1 | 53-3157 |
| | Knob (not shown) for joystick operator with latch | 1 | 53-3159 |
| 5 | Common gate (supplied with operator) | 2 | 16-3400 |
| 6 | Set screw (#6-32 x 0.250 in long hollow hex) | 2 | 11-2014 |
| 7 | Mushroom head button (includes [2] Item 6) | 1 | As Req. Below |
| | Black | — | 53-1317 |
| | Red | — | 53-1317-2 |
| | Yellow | — | 53-1317-3 |
| | Green | — | 53-1317-4 |
| | Blue | — | 53-1317-22 |
| 8 | Set screw (#10-32 x 0.250 in long hollow hex) | 2 | 11-544 |
| 9 | Jumbo mushroom head button (aluminum—includes [2] Item 8) | 1 | As Req. Below |
| | Red | — | 53-1317-9 |
| | Black | — | 53-1317-10 |
| | Yellow | — | 53-1317-11 |
| | Green | — | 53-1317-12 |
| 10 | Jumbo mushroom head button (aluminum—red EMERG. STOP) does not include Item 8 | 1 | 53-1349-18 |
| 11 | Position gate: | | |
| | Two-position | 1 | 54-7278 |
| | Three-position | 1 | 54-7173 |
| | Four-position | 1 | 54-12278 |
| | Eight-position | 1 | 54-12279 |
| 12 | Mounting screw (#6-32 x 0.710 in long) | 2 | 10250TA79 |
| | Washer | 2 | 16-2038 |
| 13 | Terminal screw and lug (captives) | Req. | 80-5502KIT |

| Item No. | Description | No. Req. | Part Number |
|----------|--|----------|----------------------|
| 14 | Gasket (supplied with basic unit) | 1 | 32-803 |
| 15 | Round head screw (#4-40 x 0.344 in long) (supplied with basic unit) | 2 | 11-4553 |
| 16 | Mounting screw | 2 | 11-1632 |
| 17 | Simple potentiometer (does not include items 18, 28 or 29) | 1 | As Req. Below |
| | 1,000 ohms | — | 41-782-2 |
| | 2,500 ohms | — | 41-782-3 |
| | 5,000 ohms | — | 41-782-10 |
| | 10,000 ohms | — | 41-782-4 |
| | 25,000 ohms | — | 41-782-5 |
| | 50,000 ohms | — | 41-782-6 |
| 18 | Connector (includes screw and lug) | 2 | 25-1851 |
| 19 | Indicating plate | 1 | As Req. Above |
| | Standard size (without legend) | — | 30-4460 |
| | Large size (specify legend) | — | 10250TR30 |
| 20 | Retaining nut | 1 | 15-1547 |
| 21 | Knob | 1 | 53-1314 |
| | Socket set screw (#6-32 x 0.250 in long) | 2 | 11-2014 |
| 22 | Coupling | 1 | 29-3749-2 |
| 23 | Set screw (#6-32 x 0.188 in long) | 1 | 11-1199 |
| 24 | Spacer | 2 | 56-1066-18 |
| 25 | Connector (includes screw and lug) | 1 | 25-1851-2 |
| 26 | Mounting nut | 1 | 15-1938 |
| 27 | Four-position joystick operating mechanism (complete) | 1 | 24-6565 |
| 28 | Four-position joystick operating mechanism (not shown) (with latch) complete | 1 | 24-6565-2 |
| 29 | Spring loaded latch | 1 | 52-1214-2 |
| 30 | Hand operated latch | 1 | 52-913-3 |

Technical Data and Specifications

Mechanical Ratings

| Description | Specification |
|----------------------------------|-----------------------------------|
| Frequency of Operation | |
| All pushbuttons | 6000 operations/hr. |
| Key and lever selection switches | 3000 operations/hr. |
| Auto-latch devices | 1200 operations/hr. |
| Life | |
| Pushbuttons | 10 x 10 ⁶ operations |
| Contact blocks | 10 x 10 ⁶ operations |
| PresTest units | 10 x 10 ⁶ operations |
| Lever and key selector switches | 0.25 x 10 ⁶ operations |
| Twist to release pushbuttons | 0.3 x 10 ⁶ operations |
| Shock Resistance | |
| Duration | 20 ms ≥5g |

General Specifications

| Description | Specification |
|--|---|
| Climate Conditions | |
| Operating temperature | 1° to 150°F (–17° to 66°C) |
| Storage temperature | –40° to 176°F (–40° to 80°C) |
| Altitude | 6,562 ft (2,000m) |
| Humidity | Max. 95% RH at 60°C |
| Terminals | |
| Marking | NC-NO on the contact block to meet the NEMA requirements. Dual marking system 1–2 for normally closed, 3–4 for normally open to meet BS5472 (Cenelec EN50 005). |
| Clamps | Terminals are saddle clamp type for 1 x 22 AWG (0.34 mm ²) to 2 x 14 AWG (2.5 mm ²) conductors |
| Torque | 7 lb-in (0.8 Nm) |
| Degree of protection against direct electrical contact | IP2X with fingerproof shroud |
| Light Units | |
| Transformers | Will withstand short-circuit for 1 hour per IEC 60997-5-1 |
| Bulbs—average life: | |
| Transformer type | 20,000 hrs. |
| Resistor/direct voltage type | 2500 hrs. minimum at rated voltage |
| LED | 60,000 to 100,000 hrs. |

Electrical Ratings

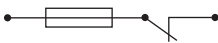
| Description | Specification |
|---|--|
| Insulation | $U_i = 660 \text{ Vac or Vdc}$ |
| Thermal | $I_{th} = 10\text{A}$ |
| Short Circuit Coordination to IEC/EN 60947-5-1 | |
| Rated conditional short circuit current | 1 kA |
| Fuse type | GE power controls TIA 10, red spot type gG, 10A, 660 Vac, 460 Vdc, BS88-2, IEC 60269-2-1 |
|  | |
| UL rating | A600, P600 |
| AC load life duty cycle 1200 operations/hour | |
| 10A | 110V pf 0.4— 1×10^6 operations |
| 5A | 250V pf 0.4— 1×10^6 operations |
| 2A | 600V pf 0.4— 1×10^6 operations |
| Switching capacity | |
| AC 15 rated make/break ($11 \times I_a$ at $1.1 \times U_e$) | |
| 6A | 120V pf 0.3 |
| 4A | 240V pf 0.3 |
| 2A | 660V pf 0.3 |
| DC13 rated make/break ($1.1 \times I_a$ at $1.1 \times U_e$) | |
| 1.0A | 125V L/R ≥ 0.95 at 300 ms |
| 0.55A | 250V L/R ≥ 0.95 at 300 ms |
| 0.1A | 660V L/R ≥ 0.95 at 300 ms |
| 10A | 110V pure resistive |
| Maximum ratings for logic level and hostile atmosphere application | |
| Maximum amperes | 0.5A |
| Maximum volts | 120 Vac/Vdc |

Electrical Ratings—Contact Block

| Description | 50 Vac or 60 Hz | | | | Vdc | | |
|---|-----------------|------|------|------|-------|-----|------|
| | 120 | 240 | 480 | 600 | 24/28 | 125 | 250 |
| Meet or Exceed NEMA Rating Designations A600, A300 and B300 for AC and P600 for DC | | | | | | | |
| Make and emerg. interrupting capacity (amp) | 60 | 30 | 15 | 12 | 5.7 | 1.1 | 0.55 |
| Normal load break (amp) | 6 | 3 | 1.5 | 1.2 | 5.7 | 1.1 | 0.55 |
| Thermal current (amp) | 10 | 10 | 10 | 10 | 5.0 | 5.0 | 5.0 |
| Voltamperes: | | | | | | | |
| Make and emerg. interrupting capacity | 7200 | 7200 | 7200 | 7200 | 138 | 138 | 138 |
| Normal load break | 720 | 720 | 720 | 720 | 138 | 138 | 138 |

Mounting Options

Panel Thickness

- Minimum: 0.06 in (1.6 mm)
- Maximum: 0.25 in (8 mm) including legend plate
- Maximum can be increased to 0.375 in (15.9 mm) using optional retaining nut
 - Indicating light: 10250TA30
 - Pushbutton/selector switch: 10250TA31

Mounting Matrix

| Legend Plate | Dimensions in Inches (mm) | | | |
|--------------|---------------------------|-------------|-------------|-------------|
| | A | B | C | D |
| Small | 1.63 (41.3) | 2.25 (57.2) | 2.25 (57.2) | 1.63 (41.3) |
| Medium | 1.75 (44.5) | 2.25 (57.2) | 2.25 (57.2) | 1.75 (44.5) |
| Large | 2.25 (57.2) | 2.25 (57.2) | 2.25 (57.2) | 2.25 (57.2) |

Mounting Options in Inches (mm)

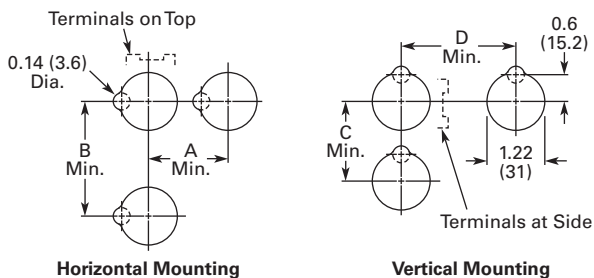

Horizontal mounting means terminals are located top and bottom of contact block. Vertical mounting means terminals are left and right of contact block. This allows close spacing of adjacent operators with easy access to terminals.

Locating nib hole or notch is 0.14 in (3.6 mm) #29 drill.

Drilling Dimensions in Inches (mm)

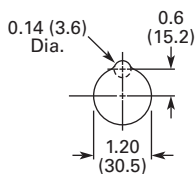

1

Dimensions

Approximate Dimensions in Inches (mm)

Mechanically Interlocked Pushbutton Operators

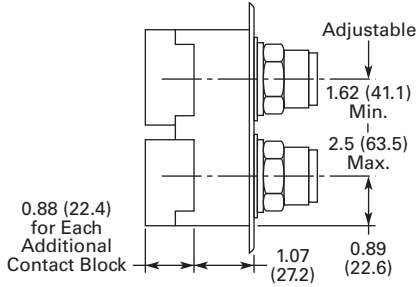

Lockout Pushbutton Operator Padlockable in the Down Position

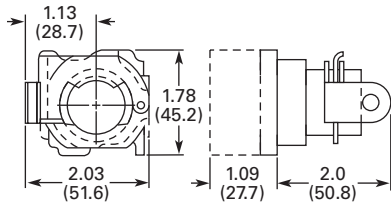

Lockout Pushbutton Operator Padlockable in the Up Position—Mushroom Head

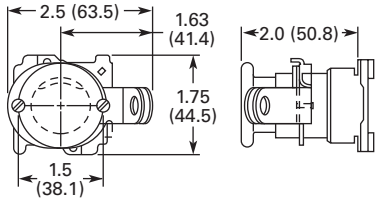

Lockout Pushbutton Operator Padlockable in the Up Position—Jumbo Mushroom Head

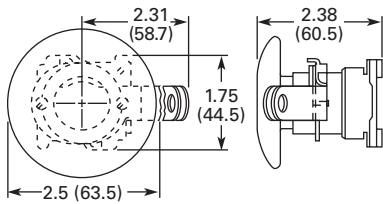

Potentiometer

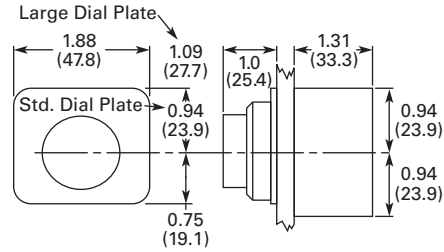

| Potentiometer | A | B | C |
|------------------------|-------------|-------------|-------------|
| 2 watt single | 1.31 (33.3) | 0.94 (23.9) | 0.94 (23.9) |
| 25 watt—up to 25 mohms | 2.38 (60.5) | 1.19 (30.2) | 0.81 (20.6) |
| 50 mohms | 2.56 (65.0) | 1.69 (42.9) | 1.25 (31.8) |

Two-Position Joystick Operator

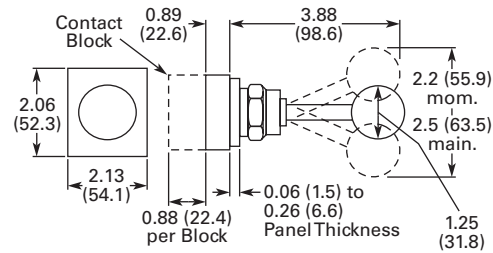

Four-Position Joystick Operator

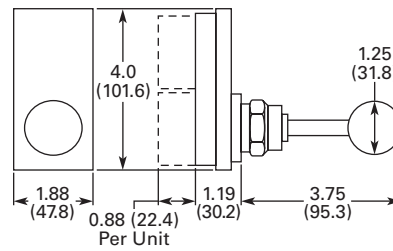

Approximate Dimensions in Inches (mm)

Key Operated Pushbutton Operator

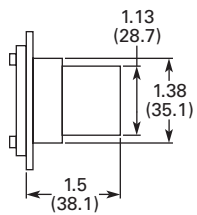

Operator and Cam

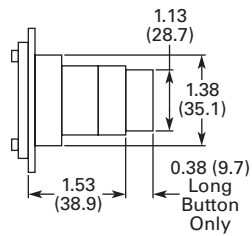

Latch-In, Twist-to-Release Operator Only with Button

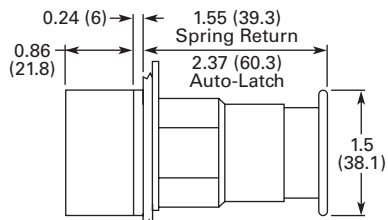

Special Rotor Latch

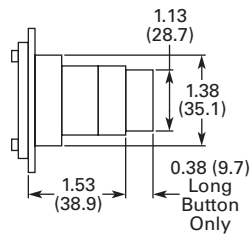

1

Approximate Dimensions in Inches (mm)

Surface Mounting

Die Cast, Polyester and Stainless Steel Enclosures

4 Mtg. Holes — 10-32 Screw Size for
 1 – 4 Element Die Cast/
 Stainless Steel Enclosure
 7/32 Screw Size for
 Polyester

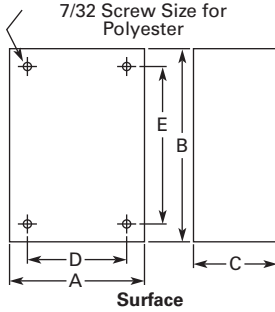

| Number of Elements | Element Arrangement | Wide A | High B | Deep C | Mounting D | E | Conduit Entrance |
|------------------------|---------------------|-------------|---------------|--------------------------|-------------|---------------|------------------|
| Die Cast | | | | | | | |
| 1 | In-line | 3.88 (98.6) | 4.00 (101.6) | 3.00 (76.3) ^① | 2.69 (68.3) | 3.25 (82.6) | 3/4 |
| 2 | | 3.88 (98.6) | 5.88 (149.4) | 3.00 (76.3) ^① | 2.69 (68.3) | 5.13 (130.3) | |
| 3 | | 3.88 (98.6) | 7.75 (196.9) | 3.00 (76.3) ^① | 2.69 (68.3) | 7.00 (177.8) | 1 |
| 4 | | 3.88 (98.6) | 9.63 (244.6) | 3.00 (76.3) ^① | 2.69 (68.3) | 8.88 (225.6) | |
| Polyester | | | | | | | |
| 1 | In-line | 3.81 (96.8) | 6.63 (168.4) | 3.38 (85.9) | 2.94 (74.7) | 4.88 (124.0) | ② |
| 2 | | 3.81 (96.8) | 6.63 (168.4) | 3.38 (85.9) | 2.94 (74.7) | 4.88 (124.0) | |
| 3 | | 3.81 (96.8) | 8.88 (225.6) | 3.38 (85.9) | 2.94 (74.7) | 7.13 (181.1) | |
| 4 | | 3.81 (96.8) | 11.13 (282.7) | 3.38 (85.9) | 2.94 (74.7) | 9.38 (238.3) | |
| Stainless Steel | | | | | | | |
| 1 | In-line | 3.00 (76.2) | 3.50 (88.9) | 3.00 (76.2) | 1.50 (38.1) | 4.25 (108.0) | ② |
| 2 | | 3.50 (88.9) | 6.75 (171.5) | 3.00 (76.2) | 1.50 (38.1) | 7.50 (190.5) | |
| 3 | | 3.50 (88.9) | 9.00 (228.6) | 3.00 (76.2) | 1.50 (38.1) | 9.00 (228.6) | |
| 4 | | 3.50 (88.9) | 11.25 (285.8) | 3.00 (76.2) | 1.50 (38.1) | 12.00 (304.8) | |

Notes

- ① Depth given is for two contact block deep stations. One contact block deep stations subtract 3/4 in (19.1 mm).
- ② No conduit entrance holes provided. Drill as required.

Approximate Dimensions in Inches (mm)

Flush Mounting

Die Cast and Stainless Steel Covers Only

4 Mtg. Holes - 10-32 Screw Size
for 1-11 Element Encl, 1/4-20
Screw Size for 12 Element
and Larger

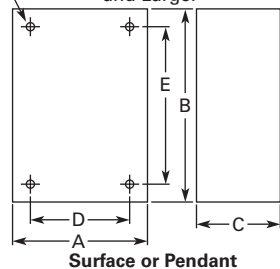

| Number of Elements | Wide A | High B | Deep C | Mounting D | E |
|------------------------|--------------|---------------|---------------|-------------|--------------|
| Die Cast | | | | | |
| 1 | 3.88 (98.6) | 4.00 (101.6) | 0.25 (6.4) ① | 3.50 (88.9) | 3.63 (92.2) |
| 2 | 3.88 (98.6) | 5.88 (149.4) | 0.25 (6.4) ① | 3.50 (88.9) | 5.50 (139.7) |
| 3 | 3.88 (98.6) | 7.75 (196.9) | 0.25 (6.4) ① | 3.50 (88.9) | 6.00 (152.4) |
| 4 | 3.88 (98.6) | 9.63 (244.6) | 0.25 (6.4) ① | 3.50 (88.9) | 9.25 (235.0) |
| Stainless Steel | | | | | |
| 1 | 5.00 (127.0) | 5.00 (127.0) | 2.50 (63.5) ② | 3.25 (82.6) | 1.88 (47.8) |
| 2 | 5.00 (127.0) | 6.88 (174.8) | 2.50 (63.5) ② | 3.25 (82.6) | 3.63 (92.2) |
| 3 | 5.00 (127.0) | 8.63 (219.2) | 2.50 (63.5) ② | 3.25 (82.6) | 5.50 (139.7) |
| 4 | 5.00 (127.0) | 10.50 (266.7) | 2.50 (63.5) ② | 3.25 (82.6) | 7.25 (184.2) |

Notes

- ① Depth given is for flat cover. Deep cover is 3/4 in (19.1 mm) deeper.
- ② Depth given includes pull box.

1.9

Pushbuttons and Indicating Lights

30.5 mm Heavy-Duty Watertight/Oiltight—10250T

1

Approximate Dimensions in Inches (mm)

Flush and Long Pushbutton Half Shroud

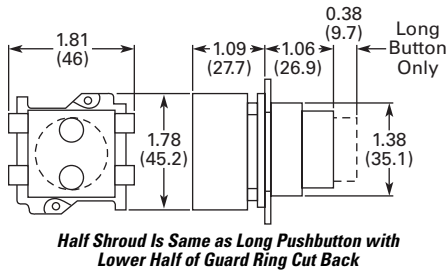

Push-Pull Switch

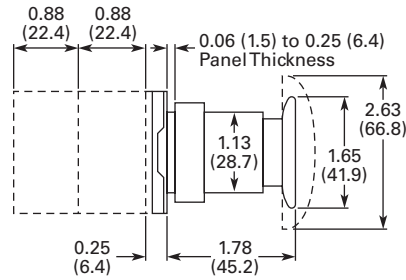

Mushroom and Jumbo Head Pushbutton

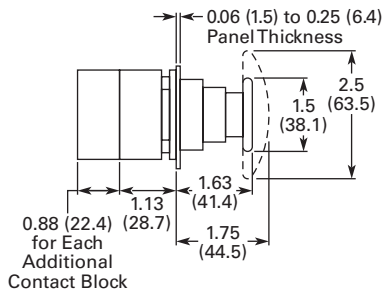

Flush Pushbutton Operator with Padlock Attachment

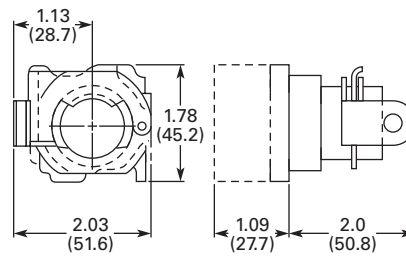

Pushbutton with Cylinder Lock

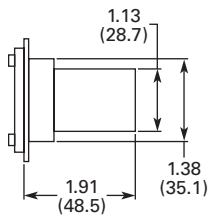

Mushroom Head Pushbutton Operator with Padlock Attachment

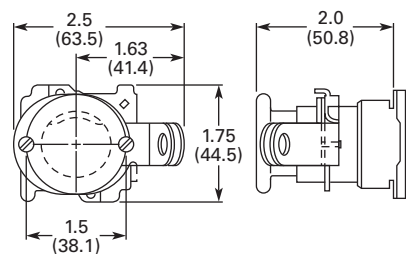

Illuminated Pushbutton

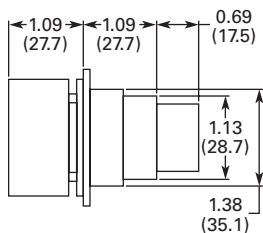

Indicating Light—Transformer Type

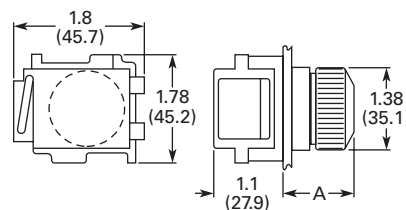

Approximate Dimensions in Inches (mm)

PresTest Indicating Light—Transformer Type

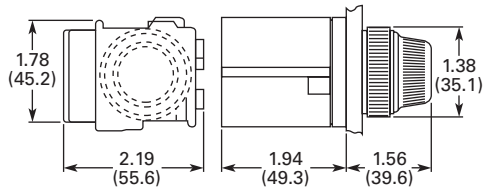

PresTest Indicating Light—Resistor Type

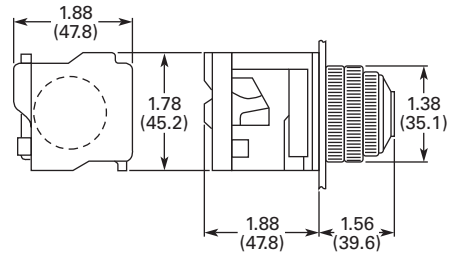

Jumbo Mushroom Head Pushbutton Operator with Padlock Attachment

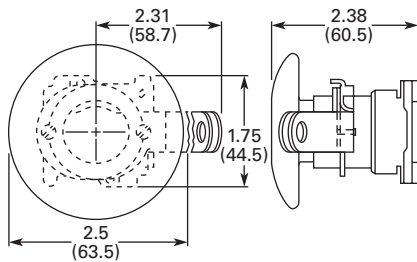

Master Test Indicating Light

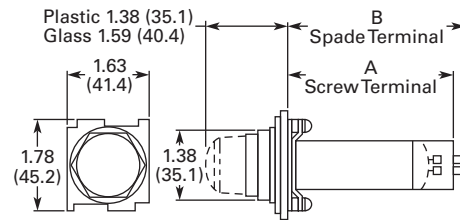

| Description | B | C |
|------------------|--------------|--------------|
| Relay type | 4.38 (111.2) | 4.28 (108.7) |
| Solid-state type | 2.94 (74.7) | 2.88 (73.2) |

Indicating Light—Resistor and Neon Type

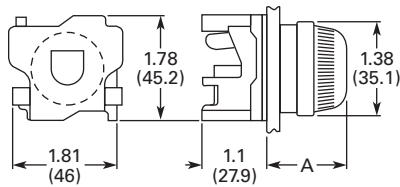

| Lens | A |
|---------|-------------|
| Plastic | 1.38 (35.1) |
| Glass | 1.56 (39.6) |

Potentiometer Shaft

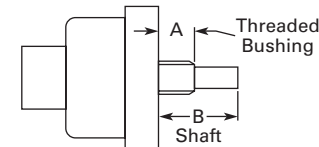

Shaft Dimensions of Potentiometer That C-H Operator Will Accept

| Operator Catalog Number | A | B |
|-------------------------|--------------------------------------|-------------------------------------|
| 10250T330 | 0.38 (9.7) dia. x 0.38 (9.7) long | 0.25 (6.4) dia. x 0.63 (16) long |

1.9

Pushbuttons and Indicating Lights

30.5 mm Heavy-Duty Watertight/Oiltight—10250T

1

Approximate Dimensions in Inches (mm)

Coin Operated Selector Switch

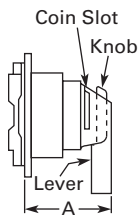

| Operator | Dim. A |
|-----------|-------------|
| Knob | 1.38 (35.1) |
| Lever | 1.50 (38.1) |
| Coin slot | 1.38 (35.1) |

Key Operated Selector Switch

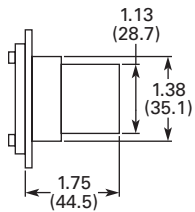

Illuminated Selector Switch

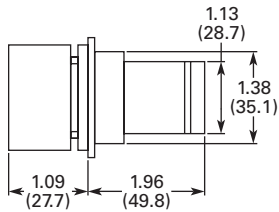

Roto-Push

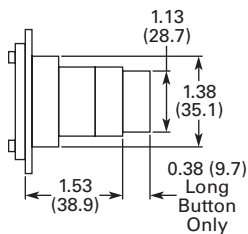

Wobble Stick Catalog No. 10250TA5

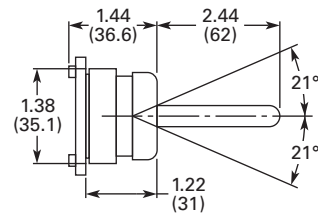

Lever Operator—For Use with Two Vertically Mounted Flush Pushbuttons Catalog No. 10250TA14

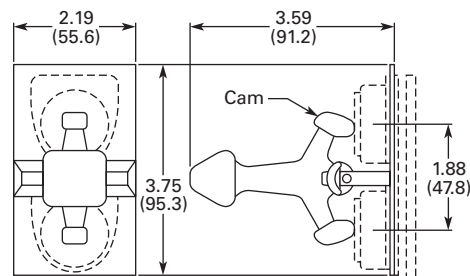

Flexible Boot—For Protecting Flush or Long Pushbutton Catalog No. 10250TA3 Typical

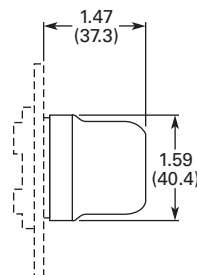

Transparent Flexible Boot—For Illuminated Pushbutton Catalog No. 10250TA25

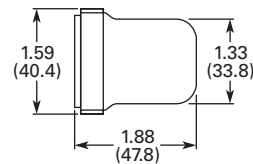

Approximate Dimensions in Inches (mm)

**Padlock Attachment—For Knob Selector Switch
Catalog No. 10250TA11**

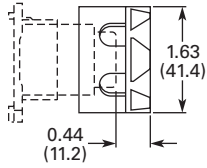

**Padlock Attachment—For Flush Pushbutton
Catalog No. 10250TA2**

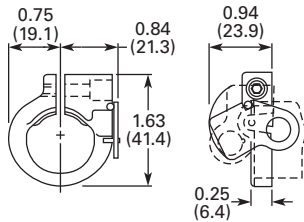

**Padlock Attachment—For Extended Pushbutton
Catalog No. 10250TA26**

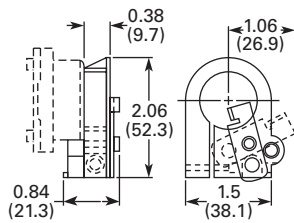

**Maintained Pushbutton
Catalog No. 10250TA66 Typical**

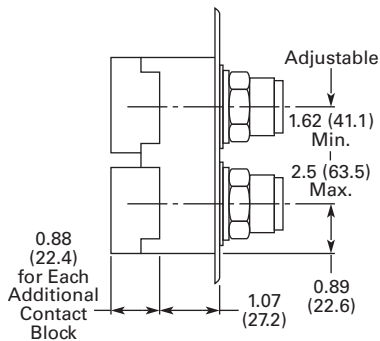

**Maintained Contact Attachment
Catalog No. 10250TA17 Typical**

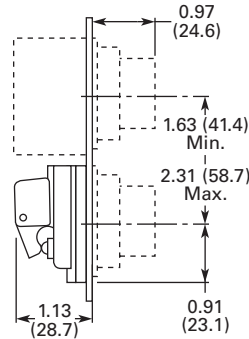

**Padlock Cover Guard for Flush Pushbutton
Catalog No. 10250TA36**

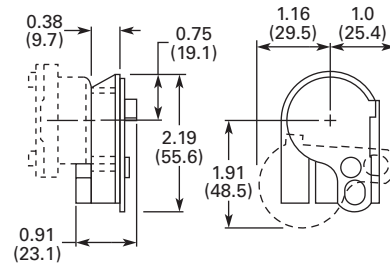

**Padlock Attachment for Maintained Push-Pull Operator
Catalog No. 10250TA64**

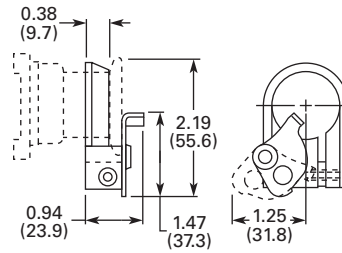

**Protecting Shroud for Jumbo Mushroom Head Button
Catalog No. 10250TA56**

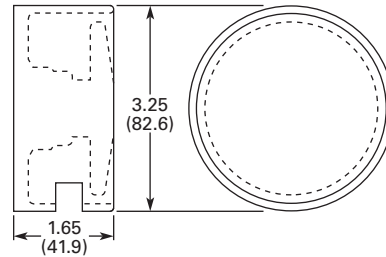

1.9

Pushbuttons and Indicating Lights

30.5 mm Heavy-Duty Watertight/Oiltight—10250T

1

Approximate Dimensions in Inches (mm)

Protecting Shroud for Mushroom Head Button Catalog No. 10250TA6

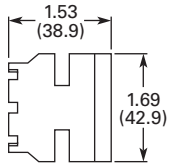

Extended Retaining Nut Catalog No. 10250TA12

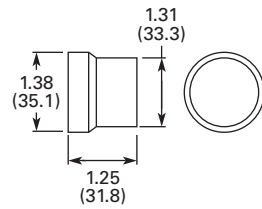

Panel Drilling and Minimum Spacing

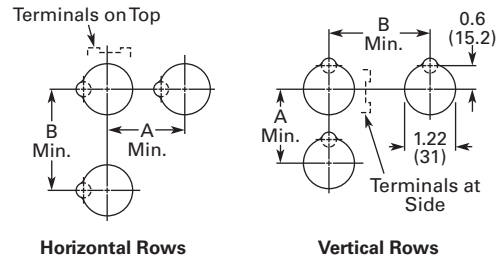

Protecting Shroud for Illuminated Pushbutton Catalog No. 10250TA15

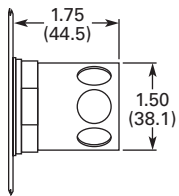

Lever for Roto-Push Operator Catalog No. 10250TA13

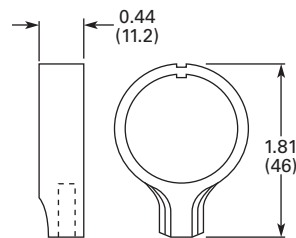

Padlock Hasp or Flip-Up Guard Catalog No. 10250TA38

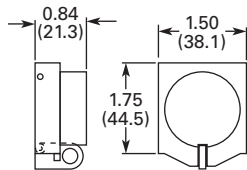

| Legend Plate | A Min. | B Min. |
|---|-------------|-------------|
| 1 or 2 Circuit Contact Blocks | | |
| Small or none | 1.63 (41.4) | 2.25 (57.2) |
| Standard | 1.75 (44.5) | 2.25 (57.2) |
| Jumbo ^① | 2.25 (57.2) | 2.25 (57.2) |
| Extra large | 2.50 (63.5) | 2.60 (66.0) |
| 4 Circuit Contact Block 10250T44 | | |
| Small or none | 1.88 (47.8) | 2.25 (57.2) |
| Standard | 1.88 (47.8) | 2.25 (57.2) |
| Jumbo ^① | 2.25 (57.2) | 2.25 (57.2) |
| Extra large | 2.50 (63.5) | 2.60 (66.0) |

Notes

Locating nib hole or notch is 1.36–1.4 in (34.5–35.6 mm) #29 drill.

^① If jumbo plates are to be placed one above the other vertically, add 0.13 (3.3) to minimum dimensions listed.

Approximate Dimensions in Inches (mm)

Multiple Button Guard

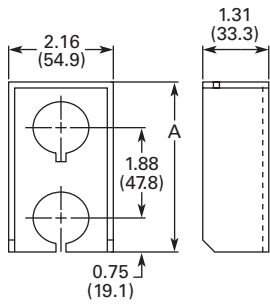

| Number of Elements | A |
|--------------------|---------------|
| 2 | 4.0 (101.6) |
| 3 | 5.88 (149.4) |
| 4 | 7.88 (200.2) |
| 7 | 13.38 (339.9) |

Chain Hook Bracket

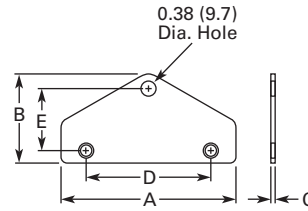

| Enclosure Size (No. of Elements) | Wide A | High B | Deep C | Mounting | |
|-------------------------------------|----------------|----------------|---------------|----------------|----------------|
| | | | | D | E |
| 2, 3 and 4 | 3.75 (95.3) | 1.94 (49.3) | 0.13 (3.3) | 2.69 (68.3) | 1.38 (35.1) |
| 6 and 7 | 4.0 (101.6) | 2.19 (55.6) | 0.13 (3.3) | 2.88 (73.2) | 1.63 (41.4) |

Master Test Module, Flasher Module and Legend Plate

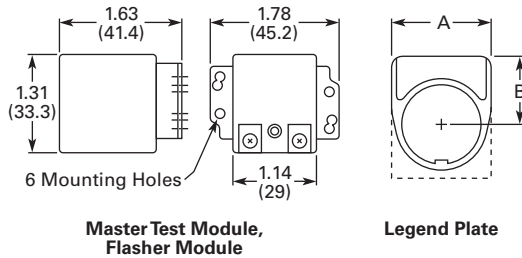

| Legend Plate | A | B |
|--------------------------------|-----------------|---------------|
| 1/2 Round Legend Plates | | |
| Small | 1.56 (39.6) | 0.91 (23.1) |
| Standard | 1.59 (40.4) | 1.07 (27.2) |
| Jumbo | 2.06 (52.3) | 1.53 (38.9) |
| Square Legend Plates | | |
| Small | 1.59 (40.4) sq. | 0.90 (22.9) |
| Standard | 1.75 (44.5) sq. | 1.06 (26.9) ① |
| Jumbo | 2.19 (55.6) sq. | 1.50 (38.1) |
| Extra large | 2.44 (62.0) sq. | 1.63 (41.4) |

Notes

Locating nib hole or notch is 1.36–1.4 in (34.5–35.6 mm) #29 drill.

① For plastic legend plate, Dimension B is 1.12 (28.4).