

3.4

Control Relays and Timers

General Purpose Plug-In Relays

Dimensions

Approximate Dimensions in Inches (mm)

D7PR1/D7PF1

3

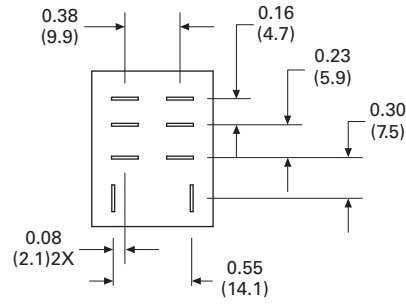
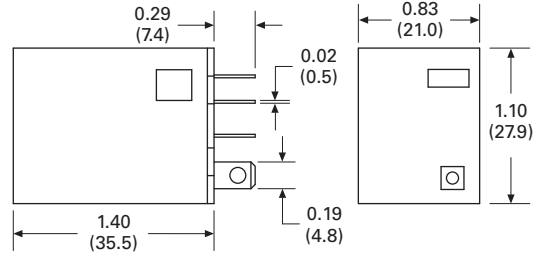
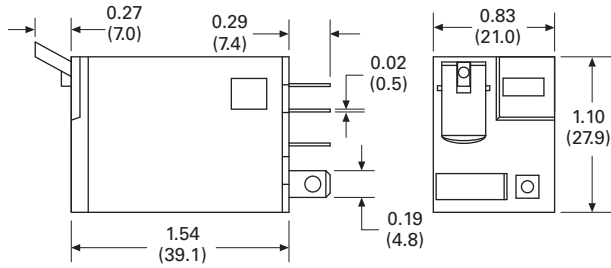

D7PR2/D7PF2

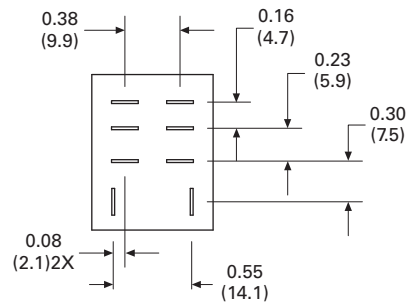
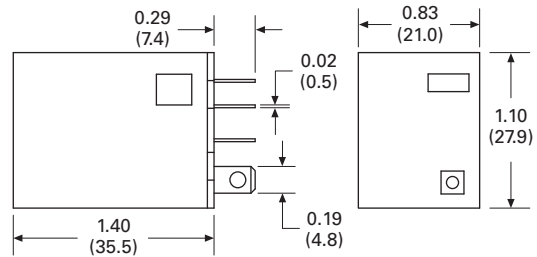
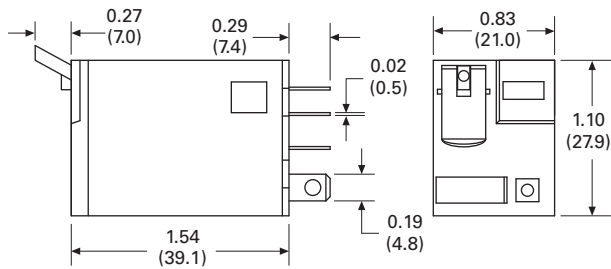

Approximate Dimensions in Inches (mm)

D7PR3/D7PF3

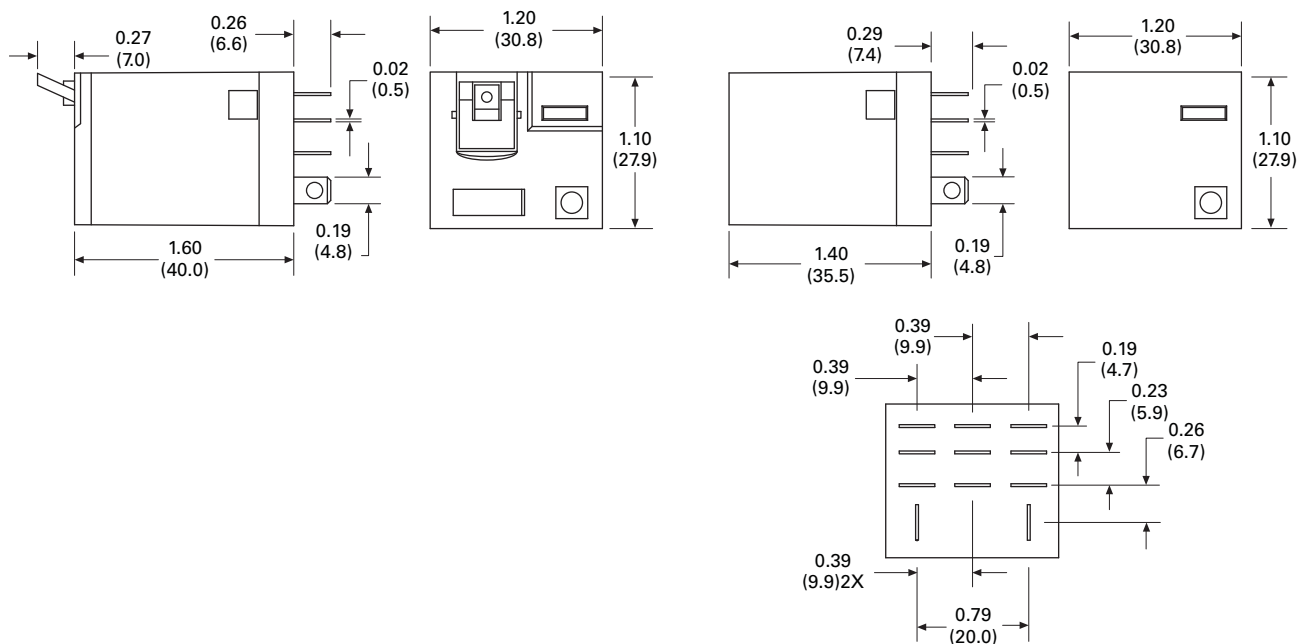

D7PR4/D7PF4

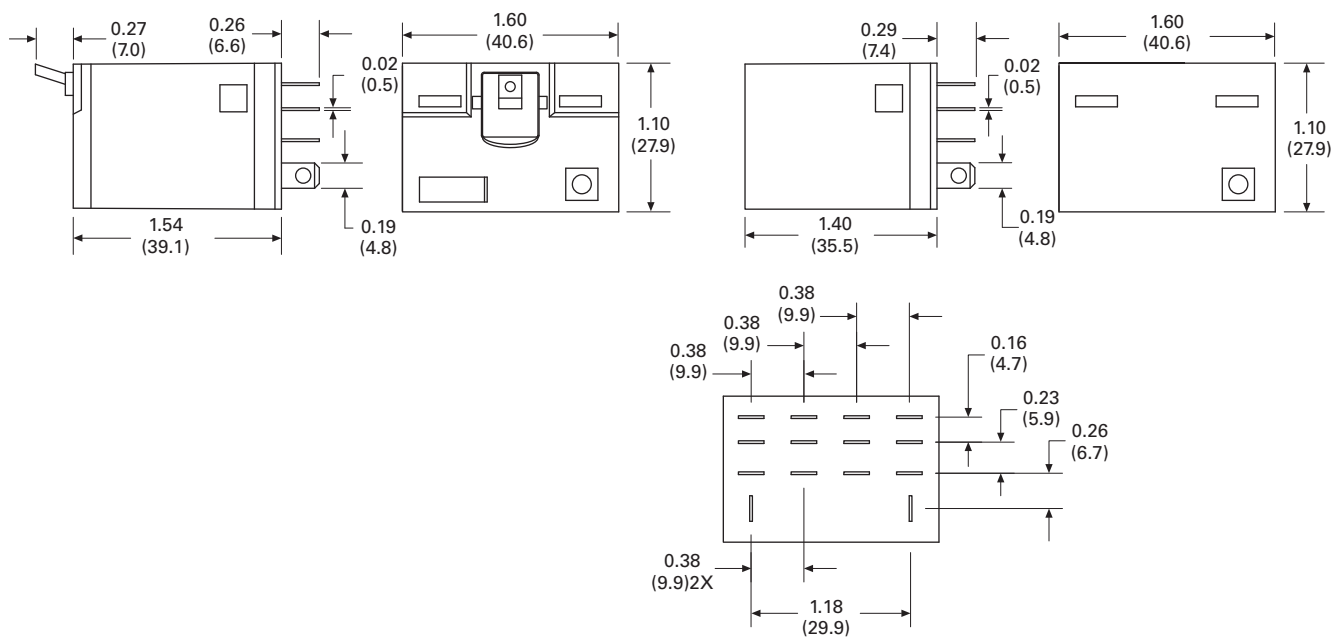

3.4

Control Relays and Timers

General Purpose Plug-In Relays

Approximate Dimensions in Inches (mm)

D7PA3

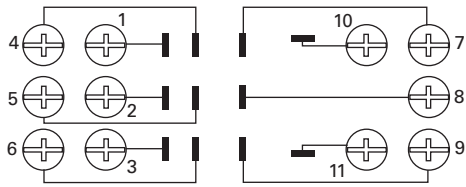

Wiring Diagram (Top View)

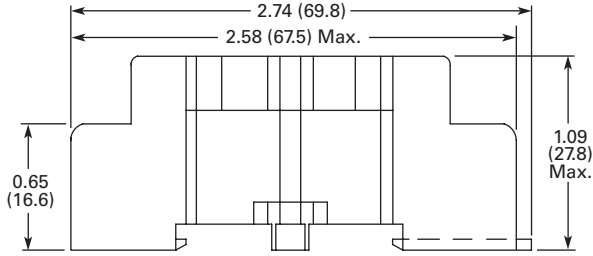

Combination Slotted/Phillips
Head Screws 6-32 x 5/16"

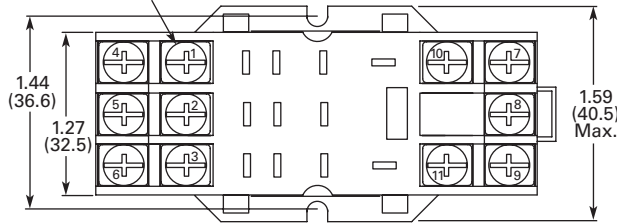

D7PA4

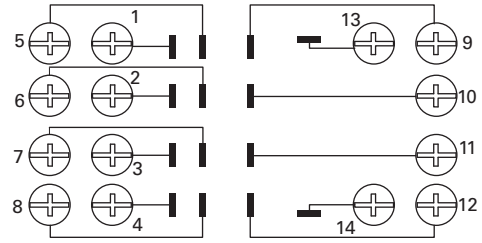

Wiring Diagram (Top View)

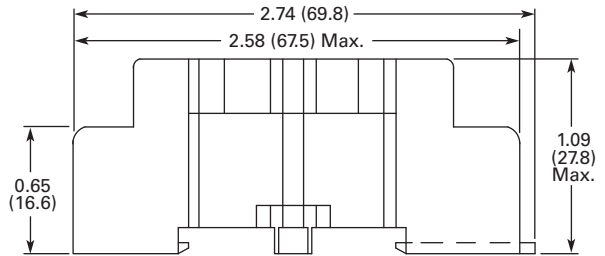

Combination Slotted/Phillips
Head Screws 6-32 x 5/16"

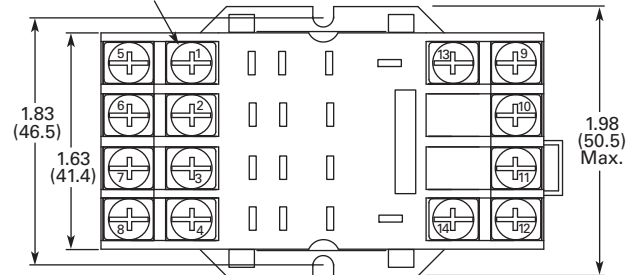

Approximate Dimensions in Inches (mm)

D7PA9 Standard Mount

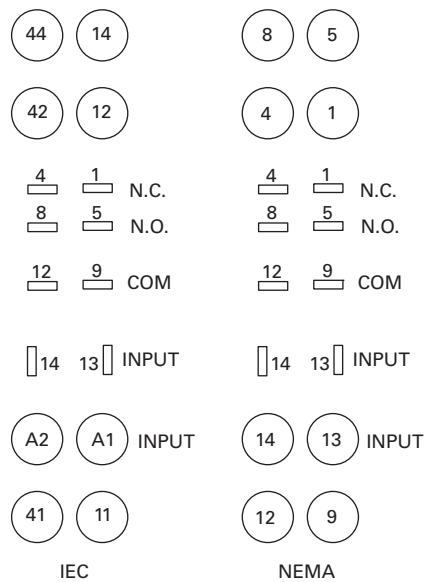
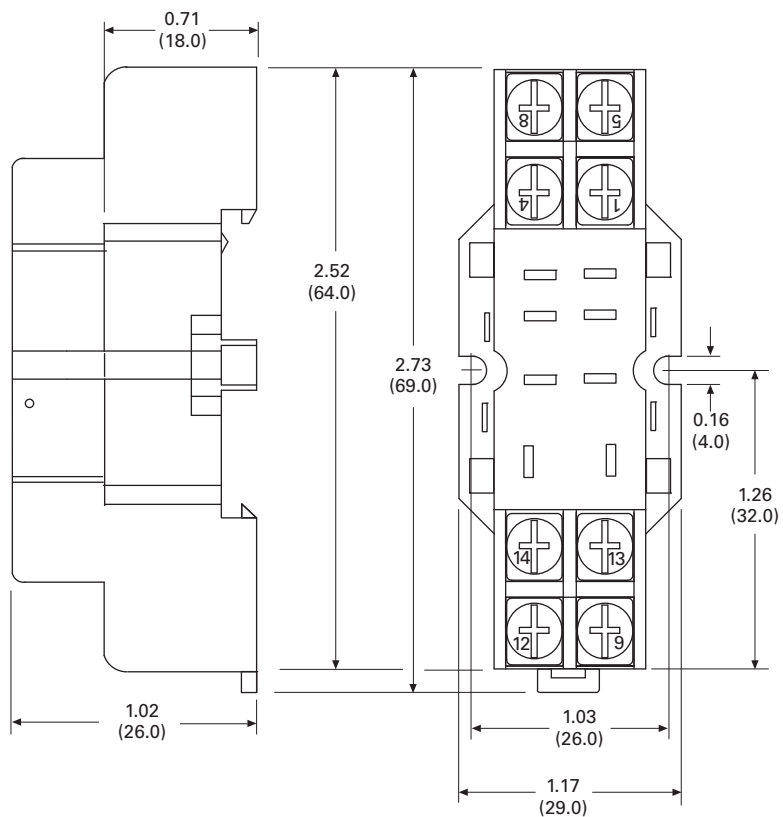

3.4

Control Relays and Timers

General Purpose Plug-In Relays

Approximate Dimensions in Inches (mm)

D7PAA

3

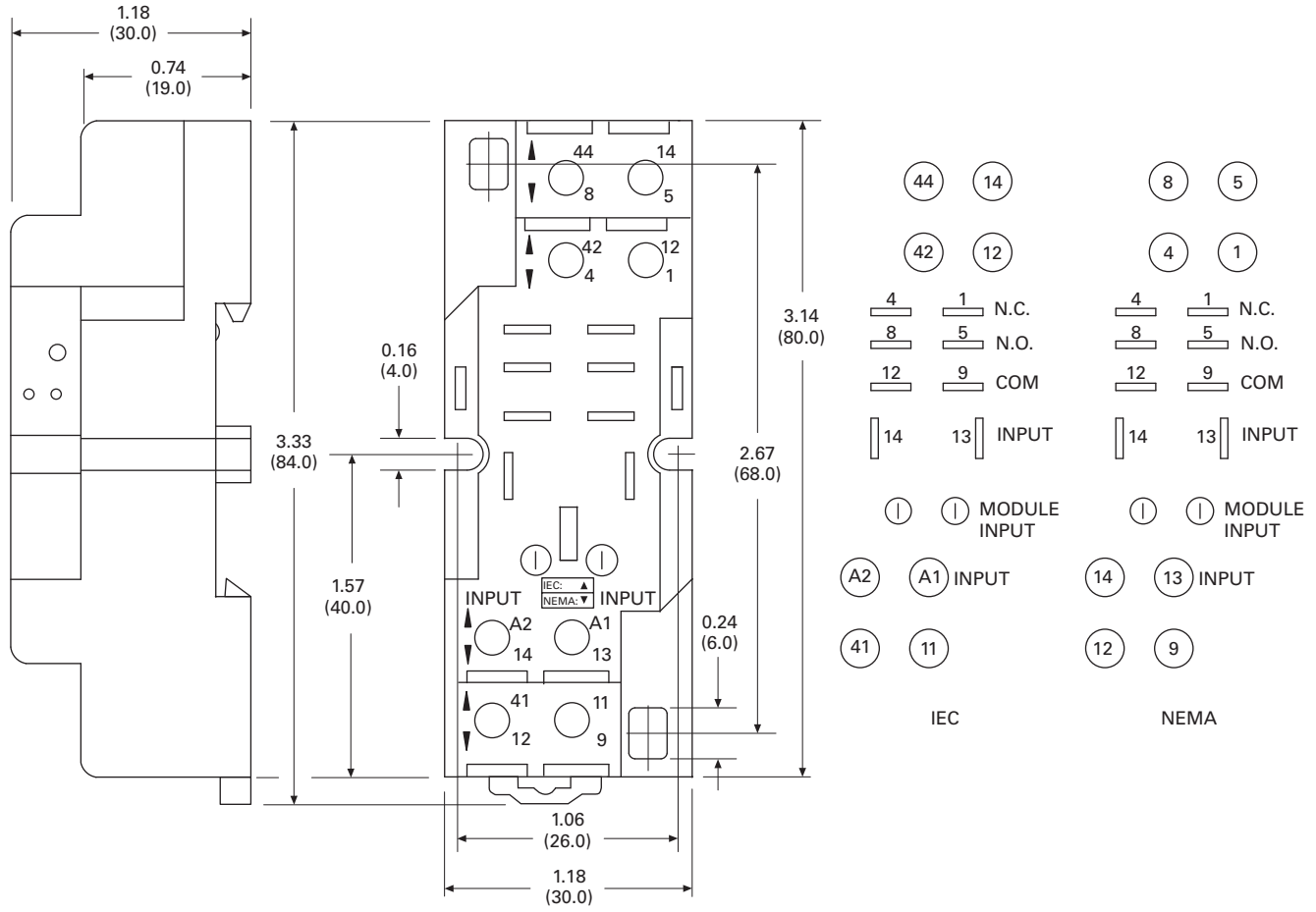

Approximate Dimensions in Inches (mm)

D7PAB

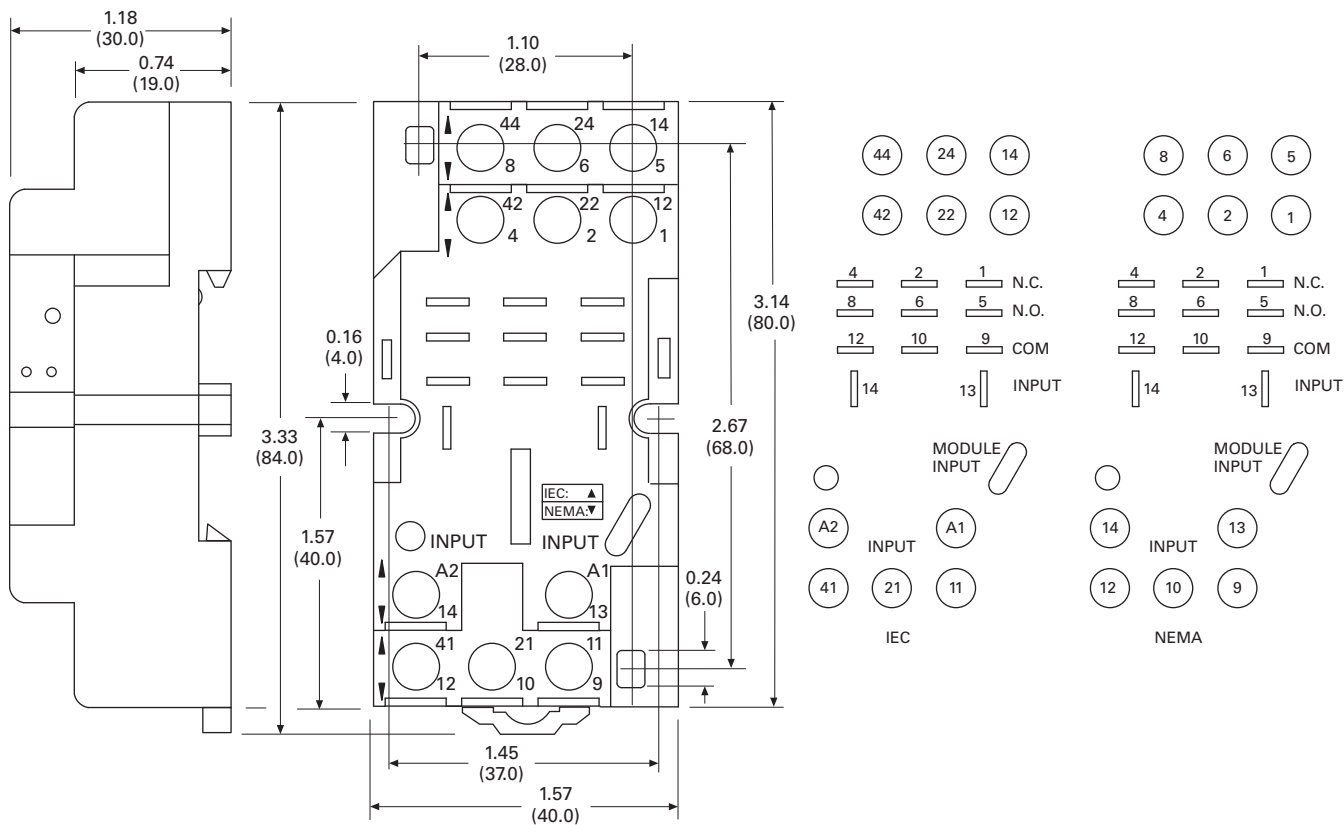

3.4

Control Relays and Timers

General Purpose Plug-In Relays

Approximate Dimensions in Inches (mm)

D7PAD

3

