

H-Max™ HVAC Drives

Quick Start Guide

Effective September 2011
Supersedes August 2011



EATON

Powering Business Worldwide

Disclaimer of Warranties and Limitation of Liability

The information, recommendations, descriptions, and safety notations in this document are based on Eaton Electrical Inc. and/or Eaton Corporation's ("Eaton") experience and judgment, and may not cover all contingencies. If further information is required, an Eaton sales office should be consulted.

Sale of the product shown in this literature is subject to the terms and conditions outlined in appropriate Eaton selling policies or other contractual agreement between Eaton and the purchaser.

THERE ARE NO UNDERSTANDINGS, AGREEMENTS, WARRANTIES, EXPRESSED OR IMPLIED, INCLUDING WARRANTIES OF FITNESS FOR A PARTICULAR PURPOSE OR MERCHANTABILITY, OTHER THAN THOSE SPECIFICALLY SET OUT IN ANY EXISTING CONTRACT BETWEEN THE PARTIES. ANY SUCH CONTRACT STATES THE ENTIRE OBLIGATION OF EATON. THE CONTENTS OF THIS DOCUMENT SHALL NOT BECOME PART OF OR MODIFY ANY CONTRACT BETWEEN THE PARTIES. In no event will Eaton be responsible to the purchaser or user in contract, in tort (including negligence), strict liability or otherwise for any special, indirect, incidental, or consequential damage or loss whatsoever, including but not limited to damage or loss of use of equipment, plant or power system, cost of capital, loss of power, additional expenses in the use of existing power facilities, or claims against the purchaser or user by its customers resulting from the use of the information, recommendations, and descriptions contained herein.

The information contained in this manual is subject to change without notice.

Cover Photo: Eaton H-Max HVAC Drives

Support Services

The goal of Eaton is to ensure your greatest possible satisfaction with the operation of our products. We are dedicated to providing fast, friendly, and accurate assistance. That is why we offer you so many ways to get the support you need. Whether it's by phone, fax, or e-mail, you can access Eaton's support information 24 hours a day, seven days a week. Our wide range of services is listed below.

You should contact your local distributor for product pricing, availability, ordering, expediting, and repairs.

Web Site

Use the Eaton Web site to find product information. You can also find information on local distributors or Eaton's sales offices.

Web Site Address

www.eaton.com/electrical

EatonCare Customer Support Center

Call the EatonCare Support Center if you need assistance with placing an order, stock availability or proof of shipment, expediting an existing order, emergency shipments, product price information, returns other than warranty returns, and information on local distributors or sales offices.

Voice: 877-ETN-CARE (386-2273) (8:00 a.m.–6:00 p.m. EST)

FAX: 800-752-8602

After-Hours Emergency: 800-543-7038
(6:00 p.m.–8:00 a.m. EST)

If you are in the U.S. or Canada, and have OI or PLC questions, you can take advantage of our toll-free line for technical assistance with hardware and software product selection, system design and installation, and system debugging and diagnostics. Technical support engineers are available for calls during regular business hours.

Technical Resource Center

Voice: 877-ETN-CARE (386-2273) (8:00 a.m.–5:00 p.m. EST)

FAX: 828-651-0549

e-mail: TRC@Eaton.com

European PanelMate Support Center

This engineering company, located in Zurich, Switzerland, provides high-level quality support and repair assistance for your PanelMate products. You will receive technical and application support.

For Customers in Europe, contact:

BFA Solutions, Ltd.

Voice: +41 1 806.64.44 (9:00 a.m.–5:00 p.m. CET)

e-mail: gk@bfa.ch

www.bfa.ch

Repair and Upgrade Service

Additional support is also available from our well-equipped Repair and Upgrade Service department. If you have questions regarding the repair or upgrade of an OI product, contact your local distributor.

Repair and Upgrade Service (support for OI)

Voice:

877-ETN-CARE (877-386-2273) (8:00 a.m.–5:00 p.m. EST)

414-449-7100 (8:00 a.m.–5:00 p.m. EST)

FAX: 614-882-3414

e-mail: TRC@eaton.com

HVAC Application

The Eaton HVAC drive contains a preloaded application for instant use.

The parameters of this application are listed in the complete Application Manual. **The Application Manual can be found at <http://www.eaton.com/Electrical/USA/ProductsandServices/AutomationandControl/AdjustableFrequencyDrives/H-Max/index.htm>.**

Specific Functions of Eaton HVAC Application

The Eaton HVAC application is an easy-to-use application for not only basic pump and fan applications where only one motor and one drive is needed, but also offers extensive possibilities for PID control.

Features

- Startup Wizard for extremely fast setup for basic pump or fan applications
- Mini-Wizards to ease the setup of applications
- Hand/Off/Auto button for easy change between Hand (keypad), OFF, and Auto (Remote control) place. The auto control place is selectable by parameter (I/O or Fieldbus)
- Control page for easy operation and monitoring of the most essential values
- Run interlock input (damper interlock). Drive will not start before this input is activated
- Different pre-heat modes used to avoid condensation problems
- Maximum output frequency 320 Hz
- Real-time clock and timer functions available (optional battery required). Possible to program three time channels to achieve different functions on the drive (for example, Start/Stop and Preset frequencies)
- External PID-controller available. Can be used to control a valve using the drive's I/O, for example
- Sleep mode function which automatically enables and disables drive running with user defined levels to save energy
- Two-zone PID-controller (two different feedback signals; minimum and maximum control)
- Two setpoint sources for the PID-control. Selectable with digital input
- PID setpoint boost function
- Feed forward function to improve the response to the process changes
- Process value supervision
- Multi-pump control
- Pressure loss compensation for compensating pressure losses in the pipework, for example, when sensor is incorrectly placed near the pump or fan

Example of Control Connections

Control Connections

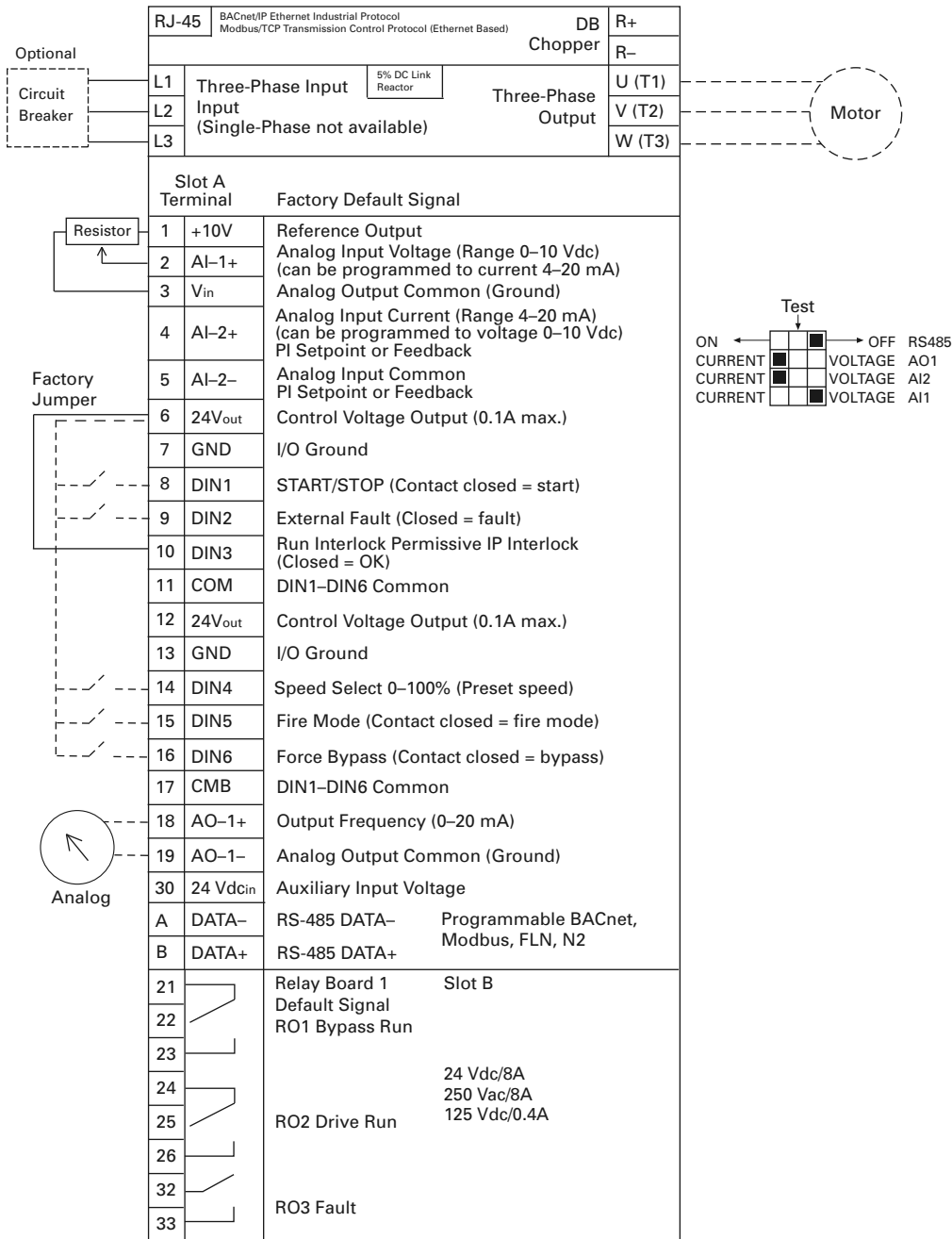

Keypad of the Drive

The control keypad is the interface between the Eaton H-MAX frequency converter and the user. With the control keypad it is possible to control the speed of a motor, to supervise the state of the equipment and to set the frequency converter's parameters.

There are two different keypads used with the H-MAX drive. The North American Keypad is slightly different than the EMEA Keypad. Functionality is quite similar. The EMEA keypad does not support the bypass functionality commonly used in the United States.

US Keypad Buttons

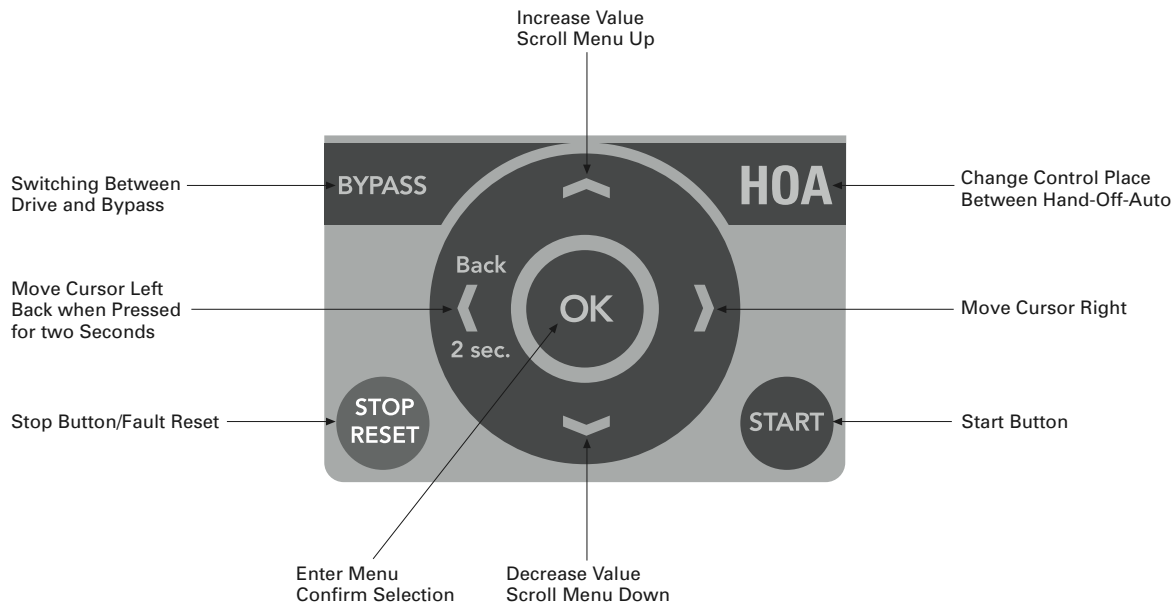

EMEA Keypad Buttons

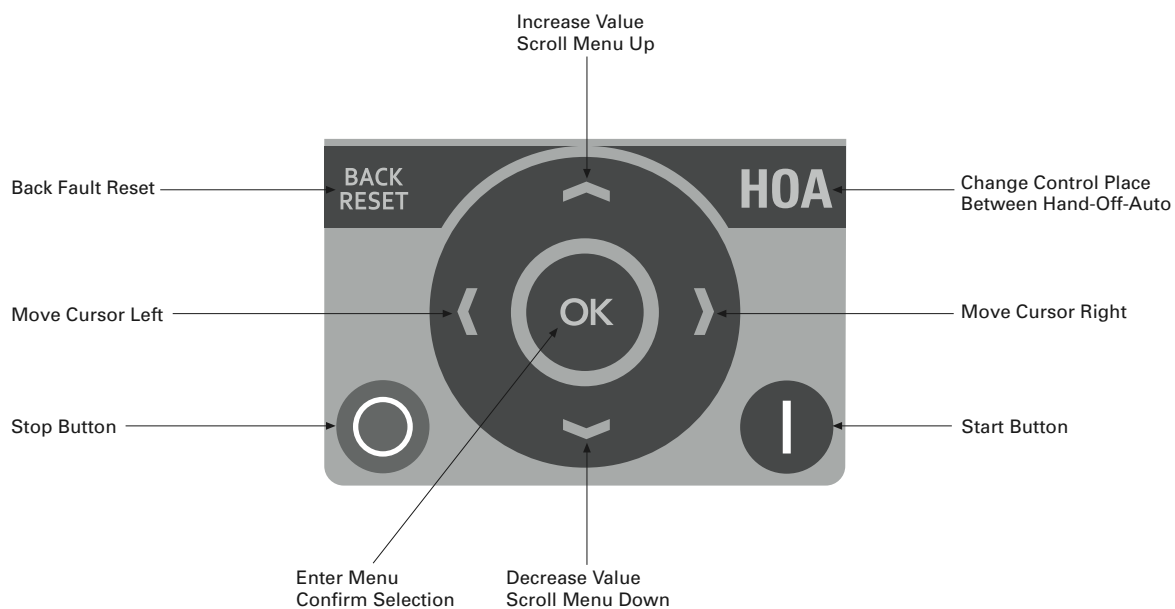

Keypad of the Drive

Keypad Display

The keypad display indicates the status of the motor and the drive and any irregularities in motor or drive functions. On the display, the user sees information about his present location in the menu structure and the item displayed.

Main Menu

The data on the control keypad are arranged in menus and submenus. Use the up and down arrows to move between the menus. Enter the group/item by pressing the OK button and return to the former level by pressing the Back/Reset button.

The *Location field* indicates your current location. The *Status field* gives information about the present status of the drive. See "Control Connections" on **Page 2**.

Main Menu

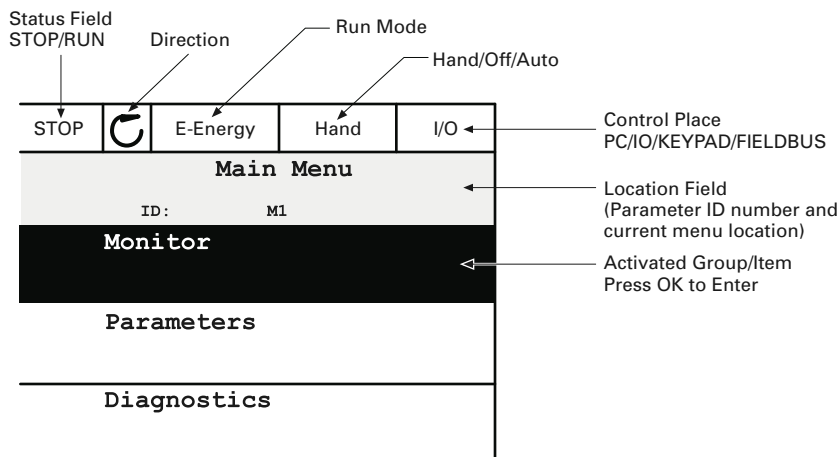

Using the Graphical Keypad

Editing Values

Change value of a parameter following the procedure below:

1. Locate the parameter.
2. Enter the *Edit* mode.
3. Set new value with the up/down arrow buttons. You can also move from digit to digit with the arrow buttons left/right if the value is numerical and then change the value with the up/down arrow buttons.
4. Confirm change with OK button or ignore change by returning to previous level with Back/Reset button.

Editing Values on Graphical Keypad

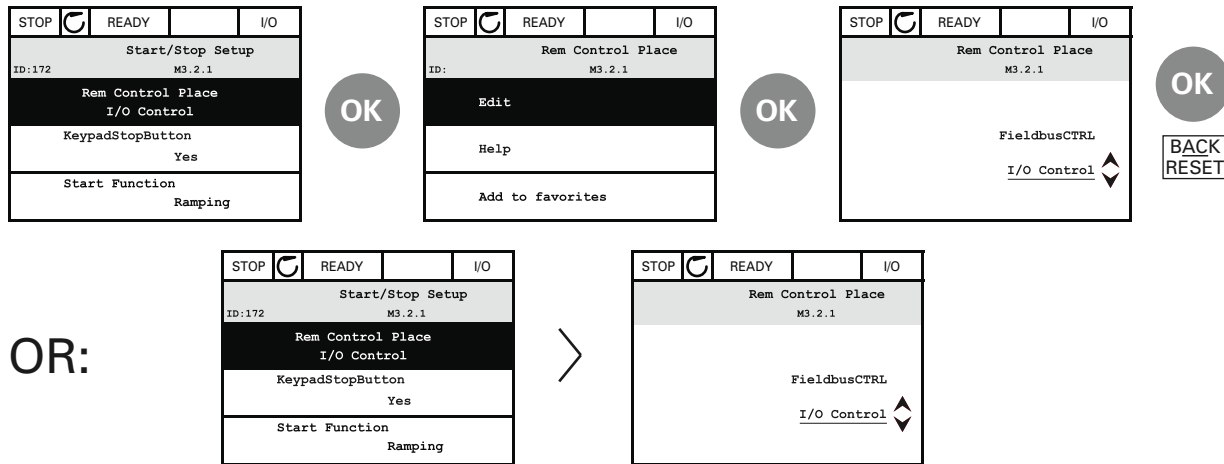

HOA Control Button

The HOA (Hand-Off-Auto) button is used for two functions: to quickly access the Control page and to easily change between the Hand (Keypad), Off, and Auto (Remote) control places.

Control Place

The *control place* is the source of control where the drive can be started and stopped. Every control place has its own parameter for selecting the frequency reference source. In the HVAC drive, the *Hand control place* is always the keypad. The *Auto control place* is determined by parameter P2.1.1 (Keypad, I/O Terminal, I/O three-wire, or Fieldbus CTRL). The selected control place can be seen on the status bar of the keypad.

Local Control

The keypad is always used as control place while in hand control. Hand control has higher priority than auto control. Therefore, if, for example, bypassed by parameter P2.1.17 through digital input while in *Remote*, the control place will still switch to Keypad if *Hand* is selected. Switching between Hand, Off, and Auto Control can be done by pressing the HOA button on the keypad.

Changing Control Place

Change of control place from *Hand* to *Auto* (keypad).

1. Anywhere in the menu structure, push the HOA button.
2. Push the *arrow up* or the *arrow down* button to select *Hand/Off/Auto* and confirm with the OK button.
3. On the next display, select *Hand, Off, or Auto* and again confirm with the OK button.
4. The display will return to the same location as it was when the HOA button was pushed. However, if the Remote control place was changed to Hand (Keypad) you will be prompted for keypad reference.

Keypad of the Drive

Accessing the Control Page

The *Control page* is meant for easy operation and monitoring of the most essential values.

1. Anywhere in the menu structure, push the *HOA* button.
2. Push the *arrow up* or the *arrow down* button to select *Control page* and confirm with the *OK* button.
3. The control page appears. If keypad control place and keypad reference are selected to be used, you can set the *Keypad reference* after having pressed the *OK* button. If other control places or reference values are used, the display will show Frequency reference which is not editable. The other values on the page are Multimonitoring values. You can choose which values appear here for monitoring (for this procedure, see Application Manual).

Accessing Control Page

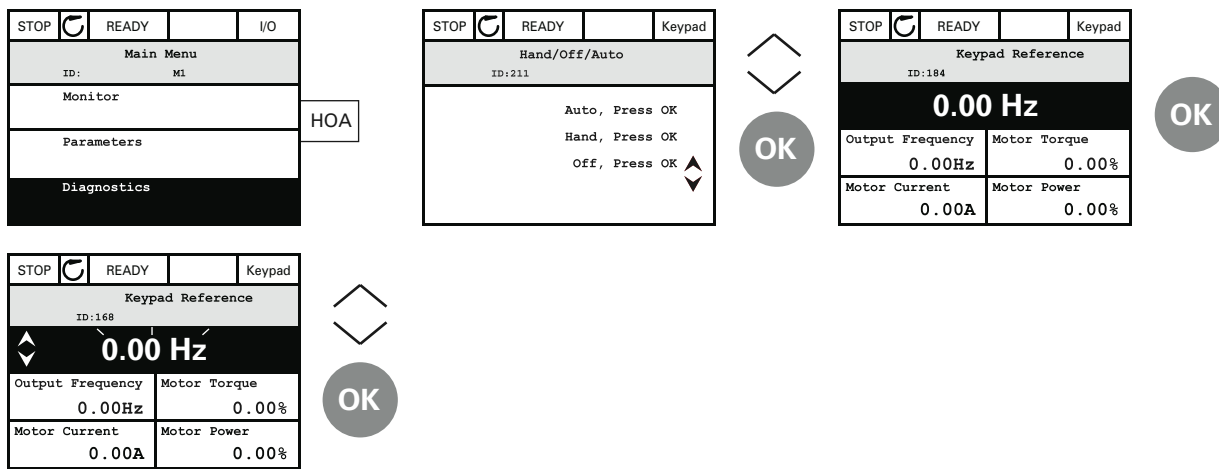

Help Texts

The graphical keypad features instant help and information displays for various items. All parameters offer an instant help display. Select Help and press the OK button. Text information is also available for faults, alarms and the Startup Wizard.

Help Text Example

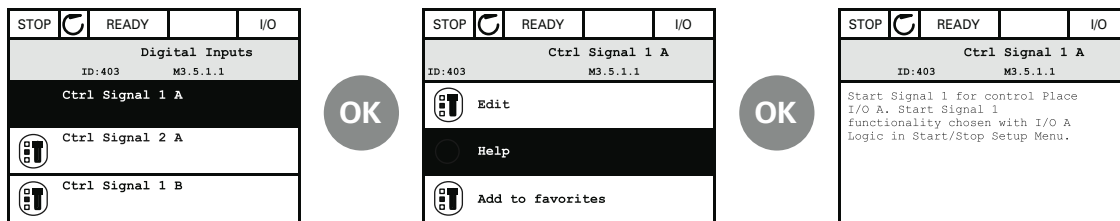

Eaton H-Max—Startup

Startup Wizard

In the *Startup Wizard*, you will be prompted for essential information needed by the drive so that it can start controlling your process. In the Wizard, you will need the following keypad buttons:



Left/Right arrows. Use these to easily move between digits and decimals.



Up/Down arrows. Use these to move between options in menu and to change value.



OK button. Confirm selection with this button.



Back/Reset button. Pressing this button, you can return to the previous question in the Wizard. If pressed at the first question, the Startup Wizard will be cancelled.

Once you have connected power to your Eaton H-Max frequency converter, follow these instructions to easily set up your drive.

1	Run Startup Wizard	Yes No
2	Language Select	Depends on language package
3	Daylight Saving ^①	Russia US EU OFF
4	Time ^①	hh:mm:ss
5	Day ^①	dd.mm.
6	Year ^①	yyyy

Note

^① These questions appear if battery is installed.

7	Application	H-Max Standard PID Multi-Pump
8	Bypass	Enabled Disabled
9	Motor Nominal Current	Min: 0.26A Max: Drive Dependent
10	Motor Nominal Voltage	Min: 180.0V Max: 690.0V
11	Motor Nominal Frequency	Min: 8 Hz Max: 320 Hz
12	Motor Nominal Speed	Min: 24 RPM Max: 19200 RPM
13	Min Frequency	Min: 0 Hz Max: 60 Hz
14	Max Frequency	Min: 12 Hz Max: 320 Hz
15	Accel Time 1	Min: 0.1s Max: 3000s
16	Decel Time 1	Min: 0.1s Max: 3000s
17	StartSourceHand	Keypad FieldbusCTRL I/O Three-Wire I/O Terminal
18	StartSourceAuto	I/O Terminal Keypad FieldbusCTRL I/O Three-Wire
19	SpeedSetptHand	Keypad Ref PID1 Activated AI1 + AI2 AI2 AI1 Fieldbus
20	SpeedSetptAuto	PID1 Activated AI1 + AI2 AI2 AI1 Fieldbus Keypad Ref

Now the Startup Wizard is done.

The Startup Wizard can be re-initiated by pressing and holding the back/reset button for two seconds. The Startup Wizard will appear upon next power up.

PID Mini-Wizard

The PID Mini-Wizard is activated in the Quick Setup menu. This Wizard presupposes that you are going to use the PID controller in the “one feedback/one setpoint” mode. The control place will be I/O A and the default process unit “%”.

The PID Mini-Wizard asks for the following values to be set:

1	FeedBack1 Srce	AI2 AI1 Not Used ProceDataIn8 ProceDataIn7 ProceDataIn6 ProceDataIn5 ProceDataIn4 ProceDataIn3 ProceDataIn2 ProceDataIn1 AI6 AI5 AI4 AI3
2	Process Unit Selection	(Several Selections)
3	Process Unit Min	—
4	Process Unit Max	—
5	P-Gain	Min: 0% Max: 200%
6	Integration Time	Min: 0.00s Max: 600.00s
7	SetPT1 Source	Keypad SP1 Not Used ProceDataIn8 ProceDataIn7 ProceDataIn6 ProceDataIn5 ProceDataIn4 ProceDataIn3 ProceDataIn2 ProceDataIn1 AI6 AI5 AI4 AI3 AI2 AI1

Multi-Pump

If Multi-Pump is the selected application, parameter group 2.16 will be visible in the menu structure. Default values may need to be adjusted to meet your application needs.

Parameter Group Name	Parameter Number	Parameter Name
Parameter Group 2.16: Multi-Pump	P2.16.1	Number of motors
	P2.16.2	Interlock function
	P2.16.3	Include FC
	P2.16.4	Autochange
	P2.16.5	Autochange interval
	P2.16.6	Autochange frequency limit
	P2.16.7	Autochange motor limit
	P2.16.8	Bandwidth
	P2.16.9	Bandwidth delay

Menu Structure

For more information, the complete Application Manual can be referenced at:

<http://www.eaton.com/Electrical/USA/ProductsandServices/AutomationandControl/AdjustableFrequencyDrives/H-Max/index.htm>.

Keypad Menus

Monitor	Basic	Diagnostics	Active Faults	
	Timer Functions		Reset Faults	
	Multimonitor		Fault History	
Parameters	Basic Parameters	I/O & Hardware	Total Counters	
	Analog Inputs		Trip Counters	
	Digital Inputs		Software Info	
	Analog Outputs		Basic I/O	
	Digital Outputs		Slot D	
	Drive Control		Slot E	
	Motor Control		Real Time Clock	
	Protections		Power Unit Settings	
	Fixed Frequencies		Keypad	
	Fire Mode		RS485	
	Multi-Pump			
	Braking		Ethernet	
	Fieldbus		User Settings	—
	Second Parameter Set		Favorites	—
	Timer Functions			

Parameter List

Parameter Group Name	Parameter Number	Parameter Name	ID
Parameter Group 2.1—Basic Parameters			
Basic	P2.1.1	Application	213
	P2.1.2	ByPass	214
	P2.1.3	HOA Control Stc	1359
	P2.1.4	Start Srce Hand	1300
	P2.1.5	Speed Setpt Hand	1301
	P2.1.6	Start Srce Auto	1302
	P2.1.7	Speed Setpt Auto	1303
	P2.1.8	Min Frequency	101
	P2.1.9	Max Frequency	102
	P2.1.10	Accel Time 1	103
	P2.1.11	Decel Time 1	104
	P2.1.12	Motor Nom Currnt	113
	P2.1.13	Motor Nom Voltg	110
	P2.1.14	Motor Nom Freq	111
	P2.1.15	Motor Nom Speed	112
	P2.1.16	MotorPowerFactor	120
	P2.1.17	Current Limit	107
	P2.1.18	Service Factor	1357
Parameter Group 2.2—Analog Inputs			
Analog Input 1	P2.2.1.1	AI1 Signal selection	377
	P2.2.1.2	AI1 Signal Inv	387
	P2.2.1.3	AI1 Signal Range	379
	P2.2.1.4	AI1 Custom Min	380
	P2.2.1.5	AI1 Custom Max	381
	P2.2.1.6	AI1 Filter Time	378
Analog Input 2	P2.2.2.1	AI2 Signal selection	388
	P2.2.2.2	AI2 Signal Inv	398
	P2.2.2.3	AI2 Signal Range	390
	P2.2.2.4	AI2 Custom Min	391
	P2.2.2.5	AI2 Custom Max	392
	P2.2.2.6	AI2 Filter Time	389
Analog Input 3	P2.2.3.1	AI3 Signal selection	141
	P2.2.3.2	AI3 Signal Inv	151
	P2.2.3.3	AI3 Signal Range	143
	P2.2.3.4	AI3 Custom Min	144
	P2.2.3.5	AI3 Custom Max	145
	P2.2.3.6	AI3 Filter Time	142

Parameter Group Name	Parameter Number	Parameter Name	ID
Parameter Group 2.2—Analog Inputs, continued			
Analog Input 4	P2.2.4.1	AI4 Signal selection	152
	P2.2.4.2	AI4 Signal Inv	162
	P2.2.4.3	AI4 Signal Range	154
	P2.2.4.4	AI4 Custom Min	155
	P2.2.4.5	AI4 Custom Max	156
	P2.2.4.6	AI4 Filter Time	153
Analog Input 5	P2.2.5.1	AI5 Signal selection	188
	P2.2.5.2	AI5 Signal Inv	198
	P2.2.5.3	AI5 Signal Range	190
	P2.2.5.4	AI5 Custom Min	191
	P2.2.5.5	AI5 Custom Max	192
	P2.2.5.6	AI5 Filter Time	189
Analog Input 6	P2.2.6.1	AI6 Signal selection	199
	P2.2.6.2	AI6 Signal Inv	209
	P2.2.6.3	AI6 Signal Range	201
	P2.2.6.4	AI6 Custom Min	202
	P2.2.6.5	AI6 Custom Max	203
	P2.2.6.6	AI6 Filter Time	200
Parameter Group 2.2—Basic Parameters			
Basic	P2.2.7.1	Ref Scale Min.	1307
	P2.2.7.2	Ref Scale Max.	1308
Parameter Group 2.3—Digital Inputs			
Digital Input 1	P2.3.1.1	DI1 Open Invert	Not accessible
	P2.3.1.2	DI1 Function	Not accessible
Digital Input 2	P2.3.2.1	DIN 2 Invert	1419
	P2.3.2.2	DIN2 Function	1320
Digital Input 3	P2.3.3.1	DIN 3 Invert	1420
	P2.3.3.2	DIN3 Function	1321
Digital Input 4	P2.3.4.1	DIN 4 Invert	1421
	P2.3.4.2	DIN4 Function	1322
Digital Input 5	P2.3.5.1	DIN 5 Invert	1422
	P2.3.5.2	DIN5 Function	1323
Digital Input 6	P2.3.6.1	DIN 6 Invert	1423
	P2.3.6.2	DIN6 Function	1324
Digital Input Ext 1	P2.3.7.1	Ext-D1 Terminal	1325
	P2.3.7.2	Ext-D1 Function	1326
Digital Input Ext 2	P2.3.8.1	Ext-D2 Terminal	1327
	P2.3.8.2	Ext-D2 Function	1328

Parameter List

Parameter Group Name	Parameter Number	Parameter Name	ID
Parameter Group 2.3—Basic Parameters			
Basic	P2.3.9.1	Start logic	1304
	P2.3.9.2	INTLK Timeout	1305
	P2.3.9.3	Delay Time	1306
	P2.3.9.4	Intrlk Stop Mode	1356
	P2.3.9.5	Interlock 1 Text	1315
	P2.3.9.6	Interlock 2 Text	1316
	P2.3.9.7	Interlock 3 Text	1317
Parameter Group 2.4—Analog Outputs			
Analog Output 1	P2.4.1.1	A01 Function	10050
	P2.4.1.2	A01 Filter Time	10051
	P2.4.1.3	A01 Min Signal	10052
	P2.4.1.4	A01 MinScale	10053
	P2.4.1.5	A01 MaxScale	10054
	P2.4.1.6	A01 Invert	10060
Parameter Group 2.5—Digital Outputs			
Digital Output 1	P2.5.1.1	RO1 function	11001
	P2.5.1.2	RO1 Invert	11020
	P2.5.1.3	RO1 ON delay	11002
	P2.5.1.4	RO1 OFF delay	11003
Digital Output 2	P2.5.2.1	RO2 function	11004
	P2.5.2.2	RO2 Invert	11021
	P2.5.2.3	RO2 ON delay	11005
	P2.5.2.4	RO2 OFF delay	11006
Digital Output 3	P2.5.3.1	RO3 function	11007
Supervision	P2.5.9.1	Superv1 Item	1622
	P2.5.9.2	Supervision #1 mode	1623
	P2.5.9.3	Supervision #1 limit	1624
	P2.5.9.4	Supervision #1 limit hysteresis	1625
	P2.5.9.5	Superv2 Item	1626
	P2.5.9.6	Supervision #2 mode	1627
	P2.5.9.7	Supervision #2 limit	1628
	P2.5.9.8	Supervision #2 limit hysteresis	1629

Parameter Group Name	Parameter Number	Parameter Name	ID
Parameter Group 2.6—Drive Control			
Basic	P2.6.1.1	Start Function	505
	P2.6.1.2	Stop Function	506
	P2.6.1.3	InhibitDirection	1336
	P2.6.1.4	Reference Unit	1362
	P2.6.1.5	Keypad Reference	184
	P2.6.1.6	Keypad Direction	123
	P2.6.1.7	Keypad Reference copy	181
	P2.6.1.8	Keypad Stop Button	114
	P2.6.1.9	Accel Time 2	502
	P2.6.1.10	Decel Time 2	503
	P2.6.1.11	RampselectMode	1333
	P2.6.1.12	Accel2Threshold	526
	P2.6.1.13	Decel2Threshold	1334
	P2.6.1.14	S-Ramp 1 Shape	500
	P2.6.1.15	S-Ramp 2 Shape	501
Skip Frequencies	P2.6.2.1	Range 1 Low Lim	509
	P2.6.2.2	Range 1 High Lim	510
	P2.6.2.3	Range 2 Low Lim	511
	P2.6.2.4	Range 2 High Lim	512
	P2.6.2.5	Range 3 Low Lim	513
	P2.6.2.6	Range 3 High Lim	514
	P2.6.2.7	Range 4 Low Lim	1337
	P2.6.2.8	Range 4 High Lim	1338
	P2.6.2.9	Range 5 Low Lim	1339
	P2.6.2.10	Range 5 High Lim	1340
	P2.6.2.11	Range 6 Low Lim	1341
	P2.6.2.12	Range 6 High Lim	1342
	P2.6.2.13	RampTimeFactor	518
Parameter Group 2.7—Motor Control			
Motor Control	P2.7.1	V/Hz RatioSelect	108
	P2.7.2	Field WeakngPnt	602
	P2.7.3	Voltage at FWP	603
	P2.7.4	V/Hz Mid Freq	604
	P2.7.5	V/Hz Mid Voltage	605
	P2.7.6	Zero Freq Voltg	606
	P2.7.7	Switching Freq	601

Parameter List

Parameter Group Name	Parameter Number	Parameter Name	ID
Parameter Group 2.8—Faults			
Faults	P2.8.1.1	AI Low Fault	700
	P2.8.1.2	Undervoltage Flt	727
	P2.8.1.3	OutputPhase Flt	702
	P2.8.1.4	Motor Duty Cycle	708
	P2.8.1.5	Underload Flt	713
	P2.8.1.6	Motor Therm Prot	704
	P2.8.1.7	MotAmbient Temp	705
	P2.8.1.8	ZeroSpeedCooling	706
	P2.8.1.9	ThermTimeConst	707
	P2.8.1.10	Thermistor Fault	732
	P2.8.1.11	External Fault	701
	P2.8.1.12	FieldbusComm Flt	733
	P2.8.1.13	InputPhaseFault	730
	P2.8.1.14	MotorStall Flt	709
	P2.8.1.15	PID1 Supervision	749
	P2.8.1.16	PID2 Supervision	757
	P2.8.1.17	SlotCommFlt	734
	P2.8.1.18	Preset Alarm Freq	183
Automatic Reset	P2.8.2.1	Automatic Reset	731
	P2.8.2.2	Restart function	719
	P2.8.2.3	Wait Time	717
	P2.8.2.4	Trial Time	718
	P2.8.2.5	Number of trials	759
	P2.8.2.6	Undervoltage Flt	720
	P2.8.2.7	Overvoltage Flt	721
	P2.8.2.8	Overcurrent Flt	722
	P2.8.2.9	AI Low Fault	723
	P2.8.2.10	UnitOverTemp Flt	724
	P2.8.2.11	MotorOverTempFlt	725
	P2.8.2.12	External Fault	726
	P2.8.2.13	IGBT temp	1358

Parameter Group Name	Parameter Number	Parameter Name	ID
Parameter Group 2.9—PID Controller			
PID Controller 1, Basic Settings	P2.9.1.1.1	Gain, PID Controller 1	118
	P2.9.1.1.2	Integration Time, PID Controller 1	119
	P2.9.1.1.3	Derivation Time, PID Controller 1	132
	P2.9.1.1.4	ProcessUnitSel, PID Controller 1	1036
	P2.9.1.1.5	ProcessUnitMin, PID Controller 1	1033
	P2.9.1.1.6	ProcessUnitMax, PID Controller 1	1034
	P2.9.1.1.7	ProcessUnitDecimals, PID Controller 1	1035
	P2.9.1.1.8	Error Inversion, PID Controller 1	340
	P2.9.1.1.9	Dead Band, PID Controller 1	1056
	P2.9.1.1.10	Dead band delay, PID Controller 1	1057
PID Controller 1, Setpoints	P2.9.1.2.1	Keypad SP 1, PID Controller 1	167
	P2.9.1.2.2	Keypad SP 2, PID Controller 1	168
	P2.9.1.2.3	Ramp Time, PID Controller 1	1068
	P2.9.1.2.4	SetPt 1 Source, PID Controller 1	332
	P2.9.1.2.5	SetPt 1 min, PID Controller 1	1069
	P2.9.1.2.6	SP 1 maximum, PID Controller 1	1070
	P2.9.1.2.7	SP 1 Sleep Freq, PID Controller 1	1016
	P2.9.1.2.8	SP 1 Sleep delay, PID Controller 1	1017
	P2.9.1.2.9	SP 1 WakeUpLevel, PID Controller 1	1018
	P2.9.1.2.10	SP 1 boost, PID Controller 1	1071
	P2.9.1.2.11	SP 2 Source, PID Controller 1	431
	P2.9.1.2.12	SP 2 minimum, PID Controller 1	1073
	P2.9.1.2.13	SP 2 maximum, PID Controller 1	1074
	P2.9.1.2.14	SP 2 Sleep Freq, PID Controller 1	1075
	P2.9.1.2.15	SP 2 Sleep delay, PID Controller 1	1076
	P2.9.1.2.16	SP 2 WakeUpLevel, PID Controller 1	1077
	P2.9.1.2.17	SP 2 boost, PID Controller 1	1078
PID Controller 1, Feedbacks	P2.9.1.3.1	Function, PID Controller 1	333
	P2.9.1.3.2	Gain, PID Controller 1	1058
	P2.9.1.3.3	FeedBack 1 Srce, PID Controller 1	334
	P2.9.1.3.4	FB 1 Minimum, PID Controller 1	336
	P2.9.1.3.5	FB 1 Maximum, PID Controller 1	337
	P2.9.1.3.6	FB 2 Source, PID Controller 1	335
	P2.9.1.3.7	FB 2 Minimum, PID Controller 1	338
	P2.9.1.3.8	FB 2 Maximum, PID Controller 1	339
PID Controller 1, Feedforward	P2.9.1.4.1	Function, PID Controller 1	1059
	P2.9.1.4.2	Gain, PID Controller 1	1060
	P2.9.1.4.3	FF 1 Source, PID Controller 1	1061
	P2.9.1.4.4	FF1 Minimum, PID Controller 1	1062
	P2.9.1.4.5	FF1 Maximum, PID Controller 1	1063
	P2.9.1.4.6	FF 2 Source, PID Controller 1	1064
	P2.9.1.4.7	FF2 Minimum, PID Controller 1	1065
	P2.9.1.4.8	FF2 Maximum, PID Controller 1	1066

Parameter List

Parameter Group Name	Parameter Number	Parameter Name	ID
Parameter Group 2.9—PID Controller, continued			
PID Controller 1, Process Supervision	P2.9.1.5.1	Enable Superv, PID Controller 1	735
	P2.9.1.5.2	Upper limit, PID Controller 1	736
	P2.9.1.5.3	Lower limit, PID Controller 1	758
	P2.9.1.5.4	Delay, PID Controller 1	737
PID Controller 1, Pressure Loss Compensation	P2.9.1.6.1	Enable SP 1, PID Controller 1	1529
	P2.9.1.6.2	SP 1 Max Comp., PID Controller 1	1530
	P2.9.1.6.3	Enable SP 2, PID Controller 1	1531
	P2.9.1.6.4	SP 2 Max Comp., PID Controller 1	1532
PID Controller 2, Basic Settings	P2.9.2.1.1	Gain, PID Controller 2	1631
	P2.9.2.1.2	Integration Time, PID Controller 2	1632
	P2.9.2.1.3	Derivation Time, PID Controller 2	1633
	P2.9.2.1.4	ProcessUnitSel, PID Controller 2	1635
	P2.9.2.1.5	ProcessUnitMin, PID Controller 2	1664
	P2.9.2.1.6	ProcessUnitMax, PID Controller 2	1665
	P2.9.2.1.7	ProcessUnitDecimals, PID Controller 2	1666
	P2.9.2.1.8	Error Inversion, PID Controller 2	1636
	P2.9.2.1.9	Dead Band, PID Controller 2	1637
	P2.9.2.1.10	Dead band delay, PID Controller 2	1638
PID Controller 2, Setpoints	P2.9.2.2.1	Keypad SP 1, PID Controller 2	1640
	P2.9.2.2.2	Keypad SP 2, PID Controller 2	1641
	P2.9.2.2.3	Ramp Time, PID Controller 2	1642
	P2.9.2.2.4	SetPt 1 Source, PID Controller 2	1643
	P2.9.2.2.5	SetPt 1 min, PID Controller 2	1644
	P2.9.2.2.6	SP 1 maximum, PID Controller 2	1645
	P2.9.2.2.7	SP 2 Source, PID Controller 2	1646
	P2.9.2.2.8	SP 2 minimum, PID Controller 2	1647
	P2.9.2.2.9	SP 2 maximum, PID Controller 2	1648
PID Controller 2, Feedbacks	P2.9.2.3.1	Function, PID Controller 2	1650
	P2.9.2.3.2	Gain, PID Controller 2	1651
	P2.9.2.3.3	FeedBack 1 Srce, PID Controller 2	1652
	P2.9.2.3.4	FB 1 Minimum, PID Controller 2	1653
	P2.9.2.3.5	FB 1 Maximum, PID Controller 2	1654
	P2.9.2.3.6	FB 2 Source, PID Controller 2	1655
	P2.9.2.3.7	FB 2 Minimum, PID Controller 2	1656
	P2.9.2.3.8	FB 2 Maximum, PID Controller 2	1657
PID Controller 2, Process Supervision	P2.9.2.4.1	Enable Superv, PID Controller 2	1659
	P2.9.2.4.2	Upper limit, PID Controller 2	1660
	P2.9.2.4.3	Lower limit, PID Controller 2	1661
	P2.9.2.4.4	Delay, PID Controller 2	1662

Parameter Group Name	Parameter Number	Parameter Name	ID
Parameter Group 2.10—Fixed Frequencies			
Fixed Frequencies	P2.10.1	Preset Freq 1	105
	P2.10.2	Preset Freq 2	106
	P2.10.3	Preset Freq 3	126
	P2.10.4	Preset Freq 4	127
	P2.10.5	Preset Freq 5	128
	P2.10.6	Preset Freq 6	129
	P2.10.7	Preset Freq 7	130
Parameter Group 2.11—Fire Mode			
Fire Mode	P2.11.1	Firemode Freq	1598
Parameter Group 2.12—Multi-Pump			
Multi-Pump	P2.12.1	Number of motors	1001
	P2.12.2	Interlock function	1032
	P2.12.3	Include FC	1028
	P2.12.4	Autochange	1027
	P2.12.5	Autochange interval	1029
	P2.12.6	Autochange: frequency limit	1031
	P2.12.7	Autochange: motor limit	1030
	P2.12.8	Bandwidth	1097
	P2.12.9	Bandwidth delay	1098
Parameter Group 2.13—Braking			
Braking	P2.13.1	DC Brake Current	507
	P2.13.2	DC Time Stop	508
	P2.13.3	DC BrakeFreqStop	515
	P2.13.4	StartMagnTime	516
	P2.13.5	StartMagnCurrent	517
	P2.13.6	Preheat Current	1335
Parameter Group 2.14—Fieldbus			
Fieldbus	P2.14.1	FB Data Out1 Sel	852
	P2.14.2	FB Data Out2 Sel	853
	P2.14.3	FB Data Out3 Sel	854
	P2.14.4	FB Data Out4 Sel	855
	P2.14.5	FB Data Out5 Sel	856
	P2.14.6	FB Data Out6 Sel	857
	P2.14.7	FB Data Out7 Sel	858
	P2.14.8	FB Data Out8 Sel	859
Parameter Group 2.15—Second Param Set			
Motor 2	P2.15.1.1	Motor Nom Currnt, Set2	1347
	P2.15.1.2	Motor Nom Voltg, Set2	1348
	P2.15.1.3	Motor Nom Freq, Set2	1349
	P2.15.1.4	Motor Nom Speed, Set2	1350
	P2.15.1.5	MotorPowerFactor, Set2	1351
	P2.15.1.6	Current Limit, Set2	1352
	P2.15.1.7	Motor Therm Prot, Set2	1353

Parameter List

Parameter Group Name	Parameter Number	Parameter Name	ID
Parameter Group 2.15—Second Param Set, continued			
Drive Control 2	P2.15.2.1	Min Frequency, Set2	1343
	P2.15.2.2	Max Frequency, Set2	1344
	P2.15.2.3	Accel Time 1, Set2	1345
	P2.15.2.4	Decel Time 1, Set2	1346
	P2.15.2.5	V/Hz RatioSelect, Set2	1355
Parameter Group 2.16—Timer Functions			
Interval 1	P2.16.1.1	ON Time, Interval 1	1670
	P2.16.1.2	Off Time, Interval 1	1671
	P2.16.1.3	From Day, Interval 1	1672
	P2.16.1.4	To Day, Interval 1	1673
	P2.16.1.5	Assign to channel, Interval 1	1674
Interval 2	P2.16.2.1	ON Time, Interval 2	1675
	P2.16.2.2	Off Time, Interval 2	1676
	P2.16.2.3	From Day, Interval 2	1677
	P2.16.2.4	To Day, Interval 2	1678
	P2.16.2.5	Assign to channel, Interval 2	1679
Interval 3	P2.16.3.1	ON Time, Interval 3	1680
	P2.16.3.2	Off Time, Interval 3	1681
	P2.16.3.3	From Day, Interval 3	1682
	P2.16.3.4	To Day, Interval 3	1683
	P2.16.3.5	Assign to channel, Interval 3	1684
Interval 4	P2.16.4.1	ON Time, Interval 4	1685
	P2.16.4.2	Off Time, Interval 4	1686
	P2.16.4.3	From Day, Interval 4	1687
	P2.16.4.4	To Day, Interval 4	1688
	P2.16.4.5	Assign to channel, Interval 4	1689
Interval 5	P2.16.5.1	ON Time, Interval 5	1690
	P2.16.5.2	Off Time, Interval 5	1691
	P2.16.5.3	From Day, Interval 5	1692
	P2.16.5.4	To Day, Interval 5	1693
	P2.16.5.5	Assign to channel, Interval 5	1694
Timer 1	P2.16.6.1	Duration	1695
	P2.16.6.2	Assign to channel	1696
Timer 2	P2.16.7.1	Duration	1697
	P2.16.7.2	Assign to channel	1698
Timer 3	P2.16.8.1	Duration	1699
	P2.16.8.2	Assign to channel	1700

Diagnostics

Under this menu, you can find *Active faults*, *Reset faults*, *Fault history*, *Counters* and *Software info*.

Active Faults

Menu	Function	Note
Active faults	When a fault/faults appear(s), the display with the name of the fault starts to blink. Press OK to return to the Diagnostics menu. The <i>Active faults</i> submenu shows the number of faults. Select the fault and push OK to see the fault-time data.	The fault remains active until it is cleared with the Reset button (push for 2s) or with a reset signal from the I/O terminal or Fieldbus or by choosing <i>Reset faults</i> (see below). The memory of active faults can store the maximum of 10 faults in the order of appearance.

Reset Faults

Menu	Function	Note
Reset faults	In this menu you can reset faults. For closer instructions.	 CAUTION! Remove external Control signal before resetting the fault to prevent unintentional restart of the drive.

Fault History

Menu	Function	Note
Fault history	40 latest faults are stored in the Fault history.	Entering the Fault history and clicking OK on the selected fault shows the fault time data (details).

Fault Codes

Fault Codes and Descriptions

Fault Code	Fault ID	Fault Name	Possible Cause	Remedy
1	1	Overcurrent (hardware fault)	AC drive has detected too high a current ($>4 \cdot I_H$) in the motor cable:	<ul style="list-style-type: none"> • Check loading • Check motor • Check cables and connections • Make identification run • Check ramp times
	2	Overcurrent (software fault)	<ul style="list-style-type: none"> • Sudden heavy load increase • Short circuit in motor cables • Unsuitable motor 	
2	10	Overvoltage (hardware fault)	The DC-link voltage has exceeded the limits defined:	<ul style="list-style-type: none"> • Make deceleration time longer • Use brake chopper or brake resistor (available as options) • Activate overvoltage controller • Check input voltage
	11	Overvoltage (software fault)	<ul style="list-style-type: none"> • Too short a deceleration time • Brake chopper is disabled • High overvoltage spikes in supply • Start/Stop sequence too fast 	
3	20	Earth fault (hardware fault)	Current measurement has detected that the sum of motor phase current is not zero:	Check motor cables and motor
	21	Earth fault (software fault)	<ul style="list-style-type: none"> • Insulation failure in cables or motor 	
5	40	Charging switch	The charging switch is open, when the START command has been given: <ul style="list-style-type: none"> • Faulty operation • Component failure 	<ul style="list-style-type: none"> • Reset the fault and restart • Should the fault re-occur, contact the distributor near to you

Fault Codes and Descriptions, continued

Fault Code	Fault ID	Fault Name	Possible Cause	Remedy	
7	60	Saturation	Various causes: <ul style="list-style-type: none"> Defective component Brake resistor short-circuit or overload 	<ul style="list-style-type: none"> Cannot be reset from keypad Switch off power DO NOT RECONNECT POWER! Contact factory If this fault appears simultaneously with F1, check motor cables and motor 	
8	600	System fault	Communication between control board and power unit has failed	Reset the fault and restart. Should the fault re-occur, contact the distributor near you	
	602		Watchdog has reset the CPU		
	603		Voltage of auxiliary power in power unit is too low		
	604		Phase fault: Voltage of an output phase does not follow the reference		
	605		CPLD has faulted but there is no detailed information about the fault		
	606		Control and power unit software are incompatible		Update software. Should the fault re-occur, contact the distributor near you
	607		Software version cannot be read. There is no software in power unit		Update power unit software. Should the fault re-occur, contact the distributor near you
	608		CPU overload. Some part of the software (for example application) has caused an overload situation. The source of fault has been suspended		Reset the fault and restart. Should the fault re-occur, contact the distributor near you
	609		Memory access has failed. For example, retain variables could not be restored		
	610		Necessary device properties cannot be read		
	647		Software error		Update software. Should the fault re-occur, contact the distributor near you
	648		Invalid function block used in application. System software and application are not compatible		
	649		Resource overload: <ul style="list-style-type: none"> Error when loading parameter initial values Error when restoring parameters Error when saving parameters 		
9	80	Undervoltage (fault)	DC link voltage is under the voltage limits defined: <ul style="list-style-type: none"> Most probable cause: Too low a supply voltage AC drive internal fault Defect input fuse External charge switch not closed Note: This fault is activated only if the drive is in Run state.	In case of temporary supply voltage break reset the fault and restart the AC drive. Check the supply voltage. If it is adequate, an internal failure has occurred. Contact the distributor near you	
	81	Undervoltage (alarm)			
10	91	Input phase	Input line phase is missing	Check supply voltage, fuses and cable	
11	100	Output phase supervision	Current measurement has detected that there is no current in one motor phase	Check motor cable and motor	

Fault Codes and Descriptions, continued

Fault Code	Fault ID	Fault Name	Possible Cause	Remedy
12	110	Brake chopper supervision (hardware fault)	<ul style="list-style-type: none"> No brake resistor installed Brake resistor is broken Brake chopper failure 	Check brake resistor and cabling. If these are OK, the chopper is faulty. Contact the distributor near you
	111	Brake chopper saturation alarm		
13	120	AC drive undertemperature (fault)	Too low temperature measured in power unit's heatsink or board. Heat-sink temperature is under -10°C	—
	121	AC drive overtemperature (alarm)		
14	130	AC drive overtemperature (fault, heatsink)	Too high temperature measured in power unit's heatsink or board. Heat-sink temperature is over 100°C	<ul style="list-style-type: none"> Check the correct amount and flow of cooling air Check the heatsink for dust Check the ambient temperature Make sure that the switching frequency is not too high in relation to ambient temperature and motor load
	131	AC drive overtemperature (alarm, heatsink)		
	132	AC drive overtemperature (fault, board)		
	133	AC drive overtemperature (alarm, board)		
15	140	Motor stalled	Motor is stalled	Check motor and load
16	150	Motor overtemperature	Motor is overloaded	Decrease motor load. If no motor overload exists, check the temperature model parameters
17	160	Motor underload	Motor is underloaded	Check load
19	180	Power overload (short-time supervision)	Drive power is too high	Decrease load
	181	Power overload (long-time supervision)		
25	—	Motor control fault	Start angle identification has failed. Generic motor control fault	—
32	312	Fan cooling	Fan lifetime is up	Change fan and reset fan lifetime counter
33	—	Fire mode enabled	Fire mode of the drive is enabled. The drive's protections are not in use	—
37	360	Device changed (same type)	Option board changed for one previously inserted in the same slot. The board's parameter settings are saved	Device is ready for use. Old parameter settings will be used
38	370	Device changed (same type)	Option board added. The option board was previously inserted in the same slot. The board's parameter settings are saved	Device is ready for use. Old parameter settings will be used
39	380	Device removed	Optional board removed from slot	Device no longer available
40	390	Device unknown	Unknown device connected (power unit/option board)	Device no longer available
41	400	IGBT temperature	IGBT temperature (unit temperature + I_2T) is too high	<ul style="list-style-type: none"> Check loading Check motor size Make identification run
43	420	Encoder fault	Encoder 1 channel A is missing	<ul style="list-style-type: none"> Check encoder connections Check encoder and encoder cable Check encoder board Check encoder frequency in open loop
	421		Encoder 1 channel B is missing	
	422		Both encoder 1 channels are missing	
	423		Encoder reversed	
	424		Encoder board missing	

Fault Codes and Descriptions, continued

Fault Code	Fault ID	Fault Name	Possible Cause	Remedy
44	430	Device changed (different type)	Option board changed for one not present in the same slot before. No parameter settings are saved	Set the option board parameters again
45	440	Device changed (different type)	Option board added. The option board was not previously present in the same slot. No parameter settings are saved	Set the option board parameters again
51	1051	External fault	Digital input	—
52	1052 1352	Keypad communication fault	The connection between the control keypad and frequency converter is broken	Check keypad connection and possible keypad cable
53	1053	Fieldbus communication fault	The data connection between the Fieldbus master and Fieldbus board is broken	Check installation and Fieldbus master
54	1354 1454 1654 1754	Slot A fault Slot B fault Slot D fault Slot E fault	Defective option board or slot	Check board and slot
65	1065	PC communication fault	The data connection between the PC and frequency converter is broken	—
66	1066	Thermistor fault	The thermistor input has detected an increase of motor temperature	<ul style="list-style-type: none"> • Check motor cooling and load • Check thermistor connection (if thermistor input is not in use it has to be short circuited)
69	1310 1311 1312	Fieldbus mapping error	<p>Non-existing ID number is used for mapping values to Fieldbus Process Data Out</p> <p>Not possible to convert one or more values for Fieldbus Process Data Out</p> <p>Overflow when mapping and converting values for Fieldbus Process Data Out (16-bit)</p>	<p>Check parameters in Fieldbus Data Mapping menu</p> <p>The value being mapped may be of undefined type. Check parameters in Fieldbus Data Mapping menu</p> <p>—</p>
101	1101	Process supervision fault (PID1)	PID controller: Feedback value outside of supervision limits (and the delay if set)	—
105	1105	Process supervision fault (PID2)	PID controller: Feedback value outside of supervision limits (and the delay if set)	—

Eaton is dedicated to ensuring that reliable, efficient and safe power is available when it's needed most. With unparalleled knowledge of electrical power management across industries, experts at Eaton deliver customized, integrated solutions to solve our customers' most critical challenges.

Our focus is on delivering the right solution for the application. But, decision makers demand more than just innovative products. They turn to Eaton for an unwavering commitment to personal support that makes customer success a top priority. For more information, **visit www.eaton.com/electrical**.

Eaton Corporation
Electrical Sector
1111 Superior Ave.
Cleveland, OH 44114
United States
877-ETN-CARE (877-386-2273)
Eaton.com

© 2011 Eaton Corporation
All Rights Reserved
Printed in USA
Publication No. MN04008004E / Z11541
September 2011

Document ID:



Eaton is a registered trademark of Eaton Corporation.

All other trademarks are property of their respective owners.