

PowerXL DH1 Series VFD

Quick Start Guide

Effective April 2018

Supersedes November 2017

CONTENTS

Step 1—PowerXL Series Overview	1
Step 2—Keypad Operation Overview	3
Step 3—Menu Navigation	6
Step 4—Startup Wizard	8
Step 5—Standard Parameter List	10
Appendix A—Fault and Warning Codes	40



Go to Eaton.com/DH1
Documents Tab: User manuals for DH1
Software Tab: To download Power Xpert *inControl* and software support

Step 1—PowerXL Series Overview

This chapter describes the purpose and contents of this manual, the receiving inspection recommendations and the PowerXL Series Open Drive catalog numbering system.

How to Use this Manual

The purpose of this manual is to provide you with information necessary to install, set and customize parameters, start up, troubleshoot and maintain the Eaton PowerXL Series variable frequency drive (VFD). To provide for safe installation and operation of the equipment, read the safety guidelines at the beginning of this manual and follow the procedures outlined in the following chapters before connecting power to the PowerXL Series VFD. Keep this operating manual handy and distribute to all users, technicians and maintenance personnel for reference.

Receiving and Inspection

The PowerXL Series VFD has met a stringent series of factory quality requirements before shipment. It is possible that packaging or equipment damage may have occurred during shipment. After receiving your PowerXL Series VFD, please check for the following:

Check to make sure that the package includes the Instruction Leaflet, Quick Start Guide, User Manual CD and accessory packet. The accessory packet includes:

- Rubber grommets
- Control cable grounding clamps
- Additional grounding screw

Inspect the unit to ensure it was not damaged during shipment.

Make sure that the part number indicated on the nameplate corresponds with the catalog number on your order.

If shipping damage has occurred, please contact and file a claim with the carrier involved immediately.

If the delivery does not correspond to your order, please contact your Eaton Electrical representative.

Note: Do not destroy the packing. The template printed on the protective cardboard can be used for marking the mounting points of the PowerXL VFD on the wall or in a cabinet.

Real Time Clock Battery Activation

To activate the real time clock (RTC) functionality in the PowerXL Series VFD, the RTC battery (already mounted in the drive) must be connected to the control board.

Simply remove the primary drive cover, locate the RTC battery directly below the keypad, and connect the white 2-wire connector to the receptacle on the control board.

Figure 1. RTC Battery Connection



Table 1. Common Abbreviations

Abbreviation	Definition
CT	Constant torque with high overload rating (150%)
VT	Variable torque with low overload rating (110%)
I _H	High Overload (150%)
I _L	Low Overload (110%)
VFD	Variable Frequency Drive

Rating Label

Figure 2. Rating Label

EATON
Powering Business Worldwide

Type: DH1-343D3FN-N21C
Style No.: 9712-1014-XX
Article No.: 9712-1014-XX
PowerXL™ DH1 VFD Factory ID: I

CT/VT		Input	Output
18.5KW/ 22KW	U(V~)	380-440 3Ø	0~Vin 3Ø
	F(Hz)	50/60 Hz	0-400 Hz
	I (A)	42.6	38/46
25HP/ 30HP	U(V~)	440-500 3Ø	0~Vin 3Ø
	F(Hz)	50/60 Hz	0-400 Hz
	I (A)	42.6	34/40

Enclosure Rating TYPE1 / IP21

User installation manual: MN040002EN
Serial No.: XXXXXXXXXX

Contains EAN Code: EAN: 4015081721450

Contains NAED Code: NAED: 786685878928

Contains SN, PN, Type, Date:

Field installed conductors must be copper rated at 75°C
XXXXXX www.eaton.com Made in China

Date Code: 20131118

Keypad Overview

Figure 3. Keypad and Display

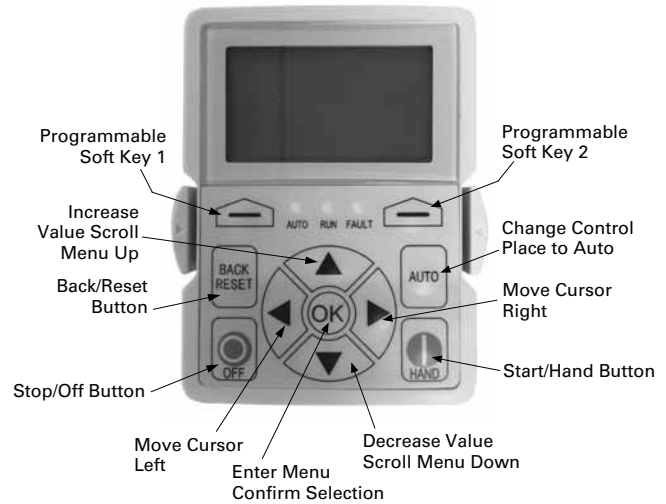

Carton Labels (U.S. and Europe)

Same as rating label shown above.



Step 2—Keypad Operation Overview

The keypad is the interface between the drive and the user. It features an LCD display, 3 LED lights and 11 buttons. With the control keypad, it is possible to control the speed of a motor, to supervise the state of the equipment and to set the frequency converter's parameters. See **Figure 3**.

Keypad Buttons



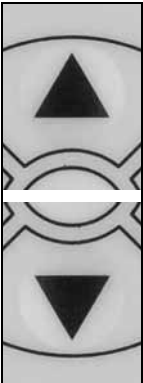

Buttons Description

Table 2. Keypad Buttons

Icon	Button	Description
	Soft Key 1, Soft Key 2	<p>Soft Key 1, Soft Key 2: The functions of these two buttons shall be the following: Forward/Reverse, this shall change motor's run direction. Reset, this shall ask MCU to reset after some parameters are modified.</p> <ul style="list-style-type: none"> • Menu, this shall return to main menu. • Details, this shall display the details of the fault. • Bypass, this shall make drive go into bypass. • Jog, this shall activate jog. • Favorite, this shall add this parameter to the Favorite menu. • Delete, this shall delete this parameter from the Favorite menu.
	Back/Reset	<p>Back/Reset: This button has three integrated functions. The button operates as backward button during normal mode. In edit mode, it is used as cancel operate. It is also used to reset faults when faults occur.</p> <ul style="list-style-type: none"> • Backs up one step. • Cancels Modify in edit mode. • Resets the active faults (all the active faults shall be reset by pressing this button more than 2s in any page).
	Auto	<p>Auto: This button switches the drive into the auto control place.</p>
	Up Down	<p>Up and Down Arrows:</p> <ul style="list-style-type: none"> • Move either up or down a menu list to select the desired menu item. • Editing a parameter bit by bit, while the active digit is scrolled. • Increase/decrease the reference value of the selected parameter. • In parameter comparison mode, scroll through the parameters of which current value is different from comparison parameter value. • In parameter page when in read mode, move to the previous or next brother parameter of this parameter.

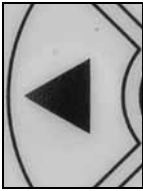
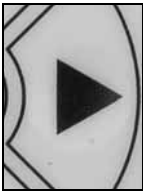

Step 2—Keypad Operation Overview

Table 2. Keypad Buttons, continued

Icon	Button	Description
	Left	<p>Left Arrow:</p> <ul style="list-style-type: none"> • Navigation button, movement to left when editing a parameter digit by digit. • Backs up one step.
	Right	<p>Right Arrow:</p> <ul style="list-style-type: none"> • Enter parameter group mode. • Enter parameter mode from group mode. • Enter parameter whole edit mode when this parameter can be written. • Enter parameter bit by bit edit mode from whole edit mode. • Navigation button, movement to right when editing a parameter bit by bit.
	OK	<p>OK:</p> <ul style="list-style-type: none"> • To clear all the Fault History if pressed for more than 5s (including 5s) in any page. • This button is used in the parameter edit mode to save the parameter setting. • To confirm the start-up list at the end of the Start-Up Wizard. • To confirm the comparison item in parameters comparison mode. <p>The following is the same with Right key:</p> <ul style="list-style-type: none"> • Enter parameter whole edit mode when this parameter can be written. • Enter parameter group mode. • Enter parameter mode from group mode.
	Stop/Off	<p>Stop/Off:</p> <p>This button operates as the motor stop button for normal operation and places the drive in the off control location. The Default is for this button to always be active. It can be changed in Parameter P4.1.3 to only when “Keypad” is selected as the control source.</p> <ul style="list-style-type: none"> • Motor stop from the keypad. • Transitions drive into an Off control location preventing start from any control source.
	Start/Hand	<p>Start/Hand:</p> <p>This button operates as motor start button for normal operation when the “Keypad” is selected as the active control source, as well as selects the Hand control place location.</p> <ul style="list-style-type: none"> • When Keypad is the reference place after hitting the start button, it will jump directly to the Keypad Ref Screen. • Places drive into Hand Control place. Hitting start again if keypad is in the control location will start the Drive.

LED Lights

Table 3. LED State Indicators

Indicator	Description
 Run	Run: Indicates that the VFD is running and controlling the load in Drive or Bypass. Blinks when a stop command has been given but the drive is still ramping down.
 Fault	Fault: Turn on when there is one or more active drive fault(s).
 Auto	Hand/OFF/Auto: Hand: If the Hand or Off control place is selected, turn off the light. Auto: If the Auto control place is selected, turn on the light.

LCD Display

The keypad LCD indicates the status of the motor and the drive and any faults in motor or drive functions. On the LCD, the user sees information about the current location in the menu structure and the item displayed.

Overview

Five lines shall be displayed in the screen. General view is as following in **Figure 4**.

Figure 4. General View of LCD

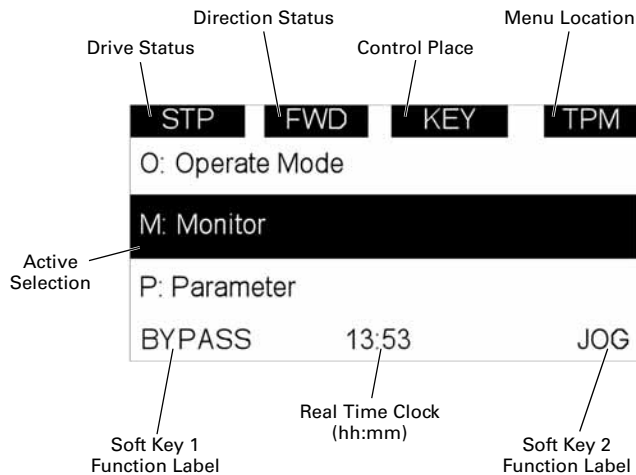

The lines definition is as below:

The first line is State line, shows:

- **RUN / STP / NRD / FIM / TFM**—If motor is running, the run state shall display "RUN"; otherwise the state display "STP". "RUN" blinks when the stop command is sent but the drive is decelerating. "NRD" is displayed if the drive is not ready or does not have a signal. "FIM" is displayed to indicate it is in Fire Mode and the drive is in a Run state. "TFM" is displayed when in the Fire Mode Test Mode and the drive is in a Run State.
- **FWD / REV / JOG**—If the motor running the direction is clockwise, it displays "FWD"; otherwise displays "REV" for counter clockwise. If "Jog" is displayed, it indicates Jog mode is active.
- **KEY / I/O / BPS / RBP / BUS / OFF**—If it is in bypass currently, display "BPS"; when run command is given, it will go to "RBP"; otherwise, if the current control source is I/O terminal, display "I/O". If it is keypad, then display "KEY"; otherwise display "BUS." When indicates "OFF", it indicates the drive will not accept a command from the Hand or Auto Control place.
- **PAR / MON / FLT / OPE / QSW / FAV / TPM / BUx**—If the current page is parameter menu, display "PAR"; If monitor menu, then display "MON"; If fault menu, then display "FLT"; If operation menu, then display "OPE"; If quick start wizard, then display "QSW"; If optional card menu, then display "BOA"; If favorite menu, then display "FAV"; If main menu, then display "TPM". "BUx" indicates the drive being a backup drive when in the redundant drive system.

The second line is Code line, which shows the menu code.

The third line is Name line, which shows the menu name or parameters name.

The fourth line is Value line, which shows the submenu name or parameters value.

The fifth line is Soft key line, the functions of Soft key 1 and Soft key 2 are changeable, and the real time is in the middle.

Step 3—Menu Navigation

Menu Structure

Table 4. Keypad Menu

Item	Description	Item	Description
Monitor	M1—Basic	Fault	F1—Active Fault
	M2—IO Status		F2—History Fault
	M3—Optional Boards		F3—Fault Log
	M4—Energy savings	Option Boards	B1—Slot A
	M5—FB Monitor Menu		B2—Slot B
	M6—PID Monitor	Favorite	
	M7—Timer/Interval Control	Operate Mode	O1—Output Frequency
	M8—User Defined Output		O2—Freq Reference
	M9—MWH Monitor		O3—Motor Speed
	M10—Multi-Monitoring		O4—Motor Current
			O5—Motor Torque
			O6—Motor Power
Parameters	P1—Basic Parameter		O7—Motor Voltage
	P2—Inputs		O8—DC-link Voltage
	P3—Outputs		O9—Unit Temperature
	P4—Drive Control		O10—Motor Temperature
	P5—Motor Control	R11—Keypad Reference	
	P6—Protections	R12—PID1 Keypad Set Point 1	
	P7—PID Controller 1	R13—PID1 Keypad Set Point 2	
	P8—PID Controller 2		
	P9—Fire Mode	Startup Wizard	S—Startup Wizard
	P10—Bypass		
	P11—Real Time Clock		
	P12—Communication		
	P13—System		

Note: Will vary depending on application selected.

Menu Navigation

This section provides basic instruction on navigating each section in the menu structure.

Figure 5. Main Menu Navigation

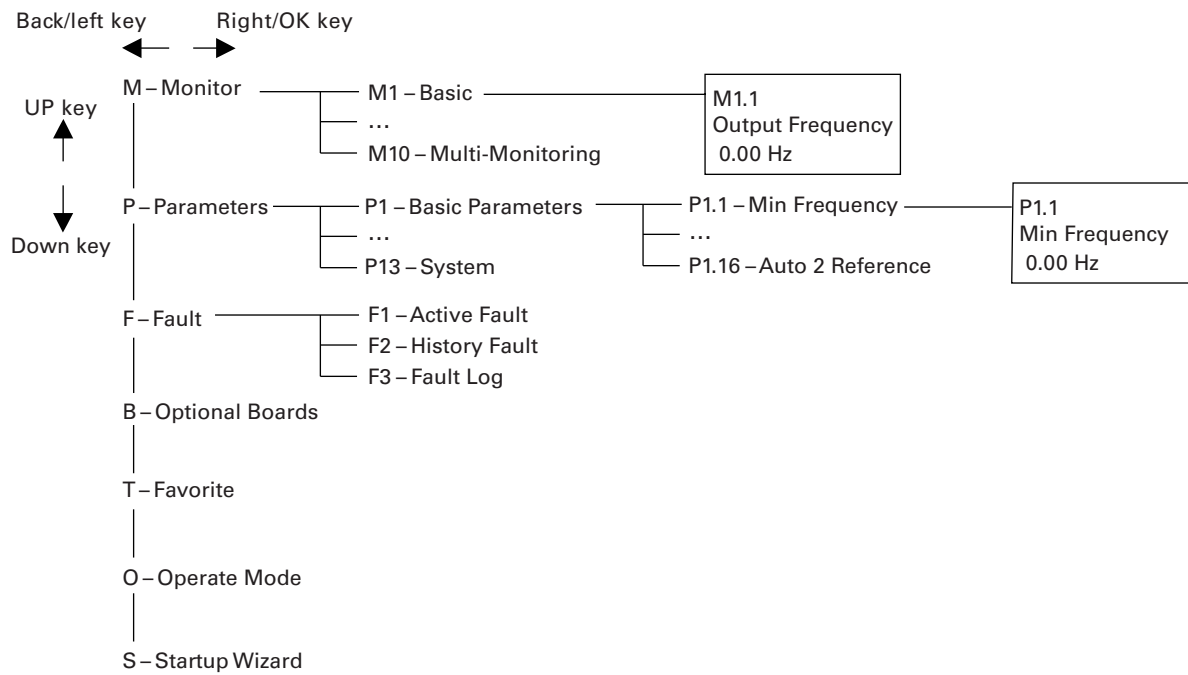

Step 4—Startup Wizard

Startup Wizard

In the *Startup Wizard*, you will be prompted for essential information needed by the drive so that it can start controlling your process. In the Wizard, you will need the following keypad buttons:



Up/Down buttons.

Use these to change value.



OK button.

Confirm selection with this button, and enter into next question.



Back/Reset button.

If this button was pressed at the first question, the Startup Wizard will be cancelled.

Once you have connected power to your Eaton PowerXL frequency converter, and the Startup Wizard is enabled, follow these instructions to easily set up your drive.

Table 5. Startup Wizard Instructions

Item	Description	
1	Startup Wizard	Press OK?
2	Application	0 = Basic 1 = PID 2 = Advanced
3	Language	0 = English 1 = 中文 2 = Deutsch
4	Real Time Clock	yy.mm.dd hh:mm:ss
5	Daylight Saving	0 = Off 1 = EU 2 = US
6	Min Frequency	Min: 0.00Hz Max: Max Frequency
7	Max Frequency	Min: Min Frequency Max: 400.00Hz
8	Motor Nom Current	Min: 0.1A Max: 500.0A
9	Current Limit	Min: $I_h * 1/10$ Max: $I_h * 2$
10	Motor Nom Speed	Min: $I_h * 1/10$ Max: $I_h * 2$
11	Motor PF	Min: 0.30 Max: 1.0
12	Motor Nom Voltage	Min: 180V Max: 690V
13	Motor Nom Frequency	Min: 30.00 Hz Max: 400.00 Hz
14	Accel Time 1	Min: 0.1 sec Max: 3000.0 sec
15	Decel Time 1	Min: 0.1 sec Max: 3000.0 sec
16	Hand Control Place	0 = Keypad 1 = I/O Terminal Start 1 2 = I/O Terminal Start 2 3 = Fieldbus

Table 5. Startup Wizard Instructions, continued

Item	Description	
17	Hand Reference	0 = AI1 1 = AI2 2 = Slot A: AI1 3 = Slot B: AI1 4 = AI1 Joystick 5 = AI2 Joystick 6 = Keypad 7 = Fieldbus 9 = Max Frequency 10 = AI1 + AI2 11 = AI1 –AI2 12 = AI2 –AI1 13 = AI1 * AI2 14 = AI1 or AI2 15 = Min(AI1,AI2) 16 = Max(AI1,AI2) 17 = PID1 Control Output 18 = PID2 Control Output
18	Auto 1 Control Place	0 = I/O Terminal Start 1 1 = Fieldbus 2 = I/O Terminal Start 2 3 = Keypad
19	Auto 1 Control Reference	0 = AI1 1 = AI2 2 = Slot A: AI1 3 = Slot B: AI1 4 = AI1 Joystick 5 = AI2 Joystick 6 = Keypad 7 = Fieldbus 9 = Max Frequency 10 = AI1 + AI2 11 = AI1 –AI2 12 = AI2 –AI1 13 = AI1 * AI2 14 = AI1 or AI2 15 = Min(AI1,AI2) 16 = Max(AI1,AI2) 17 = PID1 Control Output 18 = PID2 Control Output
20	Bypass Enabled	0 = Disabled 1 = Enabled
21	Application Mini-Wizard	Press OK?

Now the Startup Wizard is done. It won't show again when next power up. If you want to reset it, please set the Startup Wizard (P13.1.17) or select it from the main menu screen to enable and cycle the power to the drive.

Step 5—Standard Parameter List

Introduction

The Basic Application is designed for preloaded application sets for use with HVAC specific terminology and functions. It has the patent Active Energy Control algorithm that will improve your efficiency as well as minimize losses in your motor throughout the defined speed range. It provides the ability for the user to define its Hand and Auto control and reference signals with the standard Off condition as well. In addition there is the ability to scale the analog input and output signals to be read based off the desired motor response. There are also 8 digital inputs, 3 relay outputs, and 1 digital output that can be programmed to allow for control schemes that require the drive to have certain functions. It provides full customization on the motor control sequence with the ability to be in frequency or speed control mode, and tuning of the V/Hz curve can be selected. Drive/Motor protections can be customized to defined actions for added user control. Below is a list of other features that are available in the Basic Application.

Basic Application includes functions:

- Bypass control
- Fire mode
- Pre heat/cold weather mode
- Hand/Off/Auto in individual button for easy change of control mode
- Programmable protections
- Programmable digital/analog input/output function
- Programmable start/stop signal logic
- Voltage and current limiters
- Energy Savings Calculator
- Two independent set of Acceleration/Deceleration ramps
- Skip frequency
- Start source (Local/Remote control function)
- Reference source
- Flying start
- Volts per Hertz control programmable
- Real time clock—RTC time display
- Auto restart on fault to drive or bypass
- Programmable switching frequency
- Multi-preset speeds
- Fan control
- DC brake

I/O Controls

“Terminal To Function” (TTF) Programming

The design behind the programming of the digital inputs in the DH1 drive is to use “Terminal To Function” programming, which is composed of multiple functions that get assigned a digital input to that function. The parameters in the drive are set up with specific functions and by defining the digital input and slot in some cases, depending on which options are available. For use of the drives control board inputs, they will be referred to as DigIN:1 through DigIN:8. When additional option cards are used, they will be defined as DigIN:X:IOY:Z. The X indicates the slot that the card is being installed in, which will be either A or B. The IOY determines the type of card it is, which would be IO1 or IO5. The Z indicates which input is being used on that available option card.

“Function To Terminal” (FTT) Programming

The design behind the programming of the relay outputs and digital output in the DH1 drive is to use “Function To Terminal” programming. It is composed of a terminal, be it a relay output or a digital output, that is assigned a parameter. Within that parameter, it has different functions that can be set.

The parameters of the Standard Application are explained in Appendix A of application manual.

The explanations are arranged according to the parameter number. For the DI function, we use Terminal programming method to function (TTF), where there is a fixed input that gets programmed to a list of functions. This allows for multiple inputs to be used for different functions. Connecting a certain input with a certain parameter function is done by give a parameter an appropriate value. The value is formed by the location of the input, either being on the standard control board or an external option board and the slot it is located in.

Force Open/Force Close Selection

The Force Open Selection would make the selected function always off. Essentially this is a virtual switch that is always open. The Force Close Selection would make the selected function always on. Essentially this is a virtual switch that is always closed. These options are assigned to a function if we want to force a state without using a hardware input.

The standard options are DigIn: Force Open—indication that the parameter function is always going to be open, that being said depending on the logic of the function this could mean the function is always not active or always active. When the selection of a function is DigIn: Force Closed—indication that the parameter function is always going to be closed, that being said again depending on the location of the function this could mean the function is always active or not active. Examples of these options would be ID190 Start Signal 1, when set to “Force Open” and the drive is

looking at I/O terminals for control, in this case the drive would never start since this Function is always Open. If this function is set to “Force closed” the drive would always be in a start mode when in that control location.

Example:

If we set Run Enable to Force Closed the drive is always enabled. If we set the same function to Force Open the drive would never be Enabled. If a Digital input is to be used to activate this Run Enable the function should be assigned to a hardware input (See below for DIGIN Selections).

DIGIN Selection

This allows Assignment of a hardware digital input to a function, this is set in a format of DigIn:X where X is one of the 8 Digital inputs on the Main control board.

Example:

If we set Run Enable to DigI11

N:6 the drive will be enabled when digital input 6 (Terminal 8) is closed, and would not be enabled when digital input 6 (Terminal 8) is open.

Option Board digIN Selection

This allows Assignment of a hardware digital input on an option card to a function, this is set in a format of DigIn: Y:IO1:X where Y is the slot the option card is inserted on the Main control board and X is the Input on the Board and IO1 is the type of option board used.

Example:

If we set Run Enable to DigIn:A:IO5:6 the drive will be enabled when digital input 6 is closed on the IO5 option card which is inserted in Slot A, and would not be enabled when digital input 6 on the option card is open.

Timer Channel Selection

A Time Channel is a virtual path to link the digital output of a timer function to a digital input function. To utilize this feature a timer or interval would need to be assigned to a time channel 1 through 3, and the input function to be controlled would need to be assigned to the same time channel.

Example:

If we set Run Enable to DigIn:TimeChannel1 the drive will be enabled when the timer assigned to Time Channel 1 is active or High, and would not be enabled when the Time Channel is inactive or Low.

Table 6. Drive Communication Ports

Port	Communication
RJ45 Keypad Port	
Upload/Download Parameters	USB to RJ45
Remote Mount Keypad	Ethernet
Upgrade Drive Firmware	USB to RJ45
RJ45 Ethernet Port	
Upload/Download Parameters	Ethernet
BACnet/IP Communications	Ethernet
Modbus TCP Communications	Ethernet
RS-485 Serial Port ①	
Upload/Download Parameters	
Upgrade Drive Firmware	Two-Wire Twisted Pair
Modbus RTU Communications	Two-Wire Twisted Pair
BACnet MS/TP Communications	Two-Wire Twisted Pair

Note

① Shielded wire recommended.

Step 5—Standard Parameter List

Control I/O Configuration

- Run 240 Vac and 24 Vdc control wiring in separate conduit
- Communication wire to be shielded

Table 7. Analog Signals/Galaxy I/O Interface

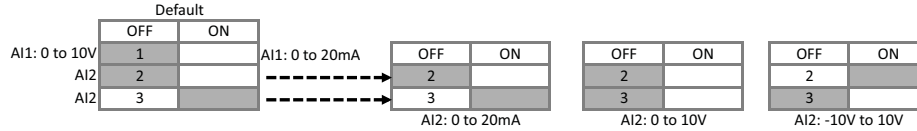

External Wiring ^①	Pin	Signal Name	Signal	Default Setting	Description
	1	+10V	Ref. Output Voltage	—	10 Vdc Supply Source
	2	AI1+ ^②	Analog Input 1	0–10V	Voltage Speed Reference (Programmable to 4 mA to 20 mA)
	3	AI1–	Analog Input 1 Ground	—	Analog Input 1 Common (Ground)
	4	AI2+ ^②	Analog Input 2	4 mA to 20 mA	Current Speed Reference (Programmable to 0–10V)
	5	AI2–	Analog Input 2 Ground	—	Analog Input 2 Common (Ground)
	6	GND	I/O Signal Ground	—	I/O Ground for Reference and Control
	7	DIN5	Digital Input 5	Preset Speed B0	Sets frequency output to Preset Speed 1
	8	DIN6	Digital Input 6	Fire Mode	Enables drive into Fire Mode
	9	DIN7	Digital Input 7	Bypass Start (TI–)	Enables drive into Bypass mode waiting for drive start
	10	DIN8	Digital Input 8	Force Auto (TI+)	Input forces drive into Auto Control place
	11	CMB	DI5 to DI8 Common	Grounded	Allows source input
	12	GND	I/O Signal Ground	—	I/O Ground for Reference and Control
	13	24V	+24 Vdc Output	—	Control voltage output (100 mA max.)
	14	DO1	Digital Output 1	Ready	Shows the drive is ready to run
	15	24Vo	+24 Vdc Output	—	Control voltage output (100 mA max.)
	16	GND	I/O Signal Ground	—	I/O Ground for Reference and Control
	17	AO1+	Analog Output 1	Output Frequency	Shows Output frequency to motor 0–60 Hz (4 mA to 20 mA)
	18	AO2+	Analog Output 2	Motor Current	Shows Motor current of motor 0–FLA (4 mA to 20 mA)
	19	24Vi	+24 Vdc Input	—	External control voltage input
	20	DIN1	Digital Input 1	Run Forward	Input starts drive in forward direction (start enable)
	21	DIN2	Digital Input 2	Run Reverse	Input starts drive in reverse direction (start enable)
	22	DIN3	Digital Input 3	External Fault	Input causes drive to fault
	23	DIN4	Digital Input 4	Fault Reset	Input resets active faults
	24	CMA	DI1 to DI4 Common	Grounded	Allows source input
	25	A/+	RS-485 Signal A	—	Fieldbus Communication (Modbus, BACnet)
	26	B/–	RS-485 Signal B	—	Fieldbus Communication (Modbus, BACnet)
	27	R3NO	Relay 3 Normally Open	Fault	Relay output 3 shows VFD is Faulted
	28	R1NC	Relay 1 Normally Closed	Bypass Run	Relay output 1 shows VFD is in a bypass run state
	29	R1CM	Relay 1 Common		
	30	R1NO	Relay 1 Normally Open		
	31	R3CM	Relay 3 Common	Fault	Relay output 3 shows VFD is Faulted
	32	R2NC	Relay 2 Normally Closed	Run	Relay output 2 shows VFD is in a drive run state
	33	R2CM	Relay 2 Common		
	34	R2NO	Relay 2 Normally Open		

Notes

- ^① The above wiring demonstrates a SINK configuration. It is important that CMA and CMB are wired to ground (as shown by dashed line). If a SOURCE configuration is desired, wire 24 V to CMA and CMB and close the inputs to ground. When using the +10 V for AI1, it is important to wire AI1–ground (as shown by dashed line). If using +10 V for AI1 or AI2, terminals 3, 5, and 6 need to be jumpered together.
- ^② AI1+ and AI2+ support 10K potentiometer.

Basic Application—Parameters List

On the next pages you will find the lists of parameters within the respective parameter groups. The parameter descriptions are given in Appendix A of application manual. The descriptions are arranged according to the parameter number.

Column explanations:

Code = Location indication on the keypad; shows the operator the present parameter number

Parameter = Name of parameter

Min = Minimum value of parameter

Max = Maximum value of parameter

Unit = Unit of parameter value; given if available

Default = Value preset by factory

ID = ID number of the parameter

Monitor

Table 8. Basic—M1

Code	Parameter	Min.	Max.	Unit	Default	ID	Note
M1.1	Output Frequency			Hz		1	
M1.2	Freq Reference			Hz		24	
M1.3	Motor Speed			rpm		2	
M1.4	Motor Current			A		3	
M1.5	Motor Torque			%		4	
M1.6	Motor Power			%		5	
M1.7	Motor Voltage			V		6	
M1.8	DC-link Voltage			V		7	
M1.9	Unit Temperature			°C		8	
M1.10	Motor Temperature			%		9	
M1.11	Latest Fault Code					28	
M1.12	Instant Motor Power			kW		1686	
M1.13	RTC Battery Status					583	0 = Not Installed 1 = Installed 2 = Change Battery 3 = OverVoltage

Notes

- ① Parameter value can only be changed after the drive has stopped.
② Parameter value will be set to be default when changing macros.

③ Input function is Level sensed.

④ Input function is Edge sensed.

⑤ Input function is Edge sensed when using StartP/StopP start logic.

Step 5—Standard Parameter List

Table 9. IO Status—M2

Code	Parameter	Min.	Max.	Unit	Default	ID	Note
M2.1	Analog Input 1			Varies		10	
M2.2	Analog Input 2			Varies		11	
M2.3	Analog Output 1			Varies		25	
M2.4	Analog Output 2			Varies		575	
M2.5	DI1, DI2, DI3					12	
M2.6	DI4, DI5, DI6					13	
M2.7	DI7, DI8					576	
M2.8	DO1, Virtual RO1, Virtual RO2					14	
M2.9	RO1, RO2, RO3					557	

Table 10. Optional Boards—M3

Code	Parameter	Min.	Max.	Unit	Default	ID	Note
M3.1	PT100 Temperature			°C	1000.0	27	

Table 11. Energy Savings—M4

Code	Parameter	Min.	Max.	Unit	Default	ID	Note
M4.1 ②	Energy Savings			Varies	0.000	2120	

Table 12. FB Monitor Menu—M5

Code	Parameter	Min.	Max.	Unit	Default	ID	Note
M5.1	Control Board DIDO Status					2209	Bit 0 = DIN1 Status Bit 1 = DIN2 Status Bit 2 = DIN3 Status Bit 3 = DIN4 Status Bit 4 = DIN5 Status Bit 5 = DIN6 Status Bit 6 = DIN7 Status Bit 7 = DIN8 Status Bit 8 = DO1 Status Bit 9 = RO1 Status Bit 10 = RO2 Status Bit 11 = RO3 Status Bit 12 = Slot A with Board Bit 13 = Slot B with Board Bit 14–15 = Not used

Notes

- ① Parameter value can only be changed after the drive has stopped.
- ② Parameter value will be set to be default when changing macros.

- ③ Input function is Level sensed.
- ④ Input function is Edge sensed.
- ⑤ Input function is Edge sensed when using StartP/StopP start logic.

Table 11. FB Monitor Menu—M5, continued

Code	Parameter	Min.	Max.	Unit	Default	ID	Note
M5.2	SlotA DIDO Status					2210	Bit 0 = I01_DIN1 Status Bit 1 = I01_DIN2 Status Bit 2 = I01_DIN3 Status Bit 3 = I01_DO1 Status Bit 4 = I01_DO2 Status Bit 5 = I01_DO3 Status Bite 6 = I03_R01 Status Bit 7 = I03_R02 Status Bit 8 = I03_R03 Status Bit 9 = I05_AC1 Status Bit 10 = I05_AC2 Status Bit 11 = I05_AC3 Status Bit 12 = I05_AC4 Status Bit 13 = I05_AC5 Status Bit 14 = I05_AC6 Status Bit 15 = Not Used
M5.3	SlotB DIDO Status					2211	Bit 0 = I01_DIN1 Status Bit 1 = I01_DIN2 Status Bit 2 = I01_DIN3 Status Bit 3 = I01_DO1 Status Bit 4 = I01_DO2 Status Bit 5 = I01_DO3 Status Bite 6 = I03_R01 Status Bit 7 = I03_R02 Status Bit 8 = I03_R03 Status Bit 9 = I05_AC1 Status Bit 10 = I05_AC2 Status Bit 11 = I05_AC3 Status Bit 12 = I05_AC4 Status Bit 13 = I05_AC5 Status Bit 14 = I05_AC6 Status Bit 15 = Not Used
M5.4	Application Status Word					29	Bit 0 = MC Ready Bit 1 = MC_Run Bit 2 = MC_Fault Bit 3 = FB_Ref_Active Bit 4 = MC_Stopping Bit 5 = MC_Reverse Bit 6 = MC_Warning/AR-Fault Bit 7 = MC_ZeroSpeed Bit 8 = I/O Control Indicate Bit 9 = Panel Control Indicator Bit 10 = Panel Fieldbus Indicator Bit 11 = MC_DC_Brake Bit 12 = RunEnable Bit 13 = Run Bypass Bit 14 = Ext Brake Control Bit 15 = Bypass Mode

Notes

- ① Parameter value can only be changed after the drive has stopped.
② Parameter value will be set to be default when changing macros.

③ Input function is Level sensed.

④ Input function is Edge sensed.

⑤ Input function is Edge sensed when using StartP/StopP start logic.

Step 5—Standard Parameter List

Table 11. FB Monitor Menu—M5, continued

Code	Parameter	Min.	Max.	Unit	Default	ID	Note
M5.5	Standard Status Word					2414	Bit 0 = See PAR ID 2415 (default = Ready) Bit 1 = See PAR ID 2416 (default = Run) Bit 2 = See PAR ID 2417 (default = Fault) Bit 3 = See PAR ID 2418 (default = Fault Invert) Bit 4 = See PAR ID 2419 (default = Warning) Bit 5 = See PAR ID 2420 (default = Reversed) Bit 6 = See PAR ID 2421 (default = At Speed) Bit 7 = See PAR ID 2422 (default = Zero Frequency) Bit 8–15 = Not Used

Table 13. User Defined Output—M8

Code	Parameter	Min.	Max.	Unit	Default	ID	Note
M8.1	Output			Varies		2445	
M8.2	Reference			Varies		2447	

Table 14. MWH Monitor—M9

Code	Parameter	Min.	Max.	Unit	Default	ID	Note
M9.1	Total MWh Count			Mwh		601	
M9.2	Total Power Day Count					603	
M9.3	Total Power Hr Count					606	
M9.4	Trip MWh Count			Mwh		604	
M9.5	Trip Power Day Count					636	
M9.6	Trip Power Hr Count					637	

Table 15. Multi-Monitoring—M10

Code	Parameter	Min.	Max.	Unit	Default	ID	Note
M10.1	Multi-Monitoring				0, 1, 2	30	

Notes

- ① Parameter value can only be changed after the drive has stopped.
- ② Parameter value will be set to be default when changing macros.

- ③ Input function is Level sensed.
- ④ Input function is Edge sensed.
- ⑤ Input function is Edge sensed when using StartP/StopP start logic.

Table 16. Operate Mode—O

Code	Parameter	Min.	Max.	Unit	Default	ID	Note
01	Output Frequency			Hz	0	1	
02	Freq Reference			Hz	0	24	
03	Motor Speed			rpm	0	2	
04	Motor Current			A	0	3	
05	Motor Torque			%	0	4	
06	Motor Power			%	0	5	
07	Motor Voltage			V	0	6	
08	DC-link Voltage			V	0	7	
09	Unit Temperature			°C	0	8	
010	Motor Temperature			%	0	9	
R11 ②	Keypad Reference	PAR ID 101	PAR ID 102	Hz	0	141	

Parameters

Table 17. Basic Parameters—P1

Code	Parameter	Min.	Max.	Unit	Default	ID	Note
P1.1 ①②	Min Frequency	0.00	See Par ID 102	Hz	0.00	101	
P1.2 ①②	Max Frequency	See Par ID 101	400.00	Hz	MaxFreqMFG	102	
P1.3 ②	Accel Time 1	0.1	3000.0	s	20.0	103	
P1.4 ②	Decel Time 1	0.1	3000.0	s	20.0	104	
P1.5 ①	Motor Nom Current	DriveNomCurr CT*1/10	DriveNomCurr CT*2	A	DriveNomCurrCT	486	
P1.6 ①	Motor Nom Speed	300	20000	rpm	MotorNomSpeed MFG	489	
P1.7 ①	Motor PF	0.30	1.00		0.85	490	
P1.8 ①	Motor Nom Voltage	180	690	V	MotorNomVoltMFG	487	
P1.9 ①	Motor Nom Frequency	8.00	400.00	Hz	MotorNomFreqMFG	488	
P1.10 ①②	HOA Source				0	2465	0 = I/O Terminal/Keypad/Fieldbus 1 = Keypad 2 = I/O Terminal 3 = Fieldbus
P1.11 ②	Hand Control Place				0	1695	0 = Keypad 1 = I/O Terminal Start 1 2 = I/O Terminal Start 2 3 = Fieldbus

Notes

- ① Parameter value can only be changed after the drive has stopped.
 ② Parameter value will be set to be default when changing macros.

- ③ Input function is Level sensed.
 ④ Input function is Edge sensed.
 ⑤ Input function is Edge sensed when using StartP/StopP start logic.

Step 5—Standard Parameter List

Table 17. Basic Parameters—P1, continued

Code	Parameter	Min.	Max.	Unit	Default	ID	Note
P1.12 ①②	Hand Reference				6	136	0 = AI1 1 = AI2 2 = Slot A: AI1 3 = Slot B: AI1 6 = Keypad 7 = Fieldbus Ref 9 = Max Frequency 10 = AI1 + AI2 11 = AI1 - AI2 12 = AI2 - AI1 13 = AI1 * AI2 14 = AI1 or AI2 15 = MIN(AI1,AI2) 16 = MAX(AI1,AI2)
P1.13 ②	Auto 1 Control Place				0	135	0 = I/O Terminal Start 1 1 = Fieldbus 2 = I/O Terminal Start 2 3 = Keypad
P1.14 ①②	Auto 1 Reference				1	137	See Par ID 136
P1.15 ②	Auto 2 Control Place				1	138	See Par ID 135
P1.16 ①②	Auto 2 Reference				7	139	See Par ID 136

Inputs

Table 18. Basic Setting—P2.1

Code	Parameter	Min.	Max.	Unit	Default	ID	Note
P2.1.4 ②	AI Ref Scale Min Value	0.00	See Par ID 145	Hz	0.00	144	
P2.1.5 ②	AI Ref Scale Max Value	See Par ID 144	400.00	Hz	0.00	145	

Table 19. Digital Input—P2.2

Code	Parameter	Min.	Max.	Unit	Default	ID	Note
P2.2.1 ①②	IO Terminal 1 Start Stop Logic				0	143	0 = Forward - Reverse 1 = Start - Reverse 2 = Start - Enable 3 = Start Pulse - Stop Pulse

Notes

- ① Parameter value can only be changed after the drive has stopped.
② Parameter value will be set to be default when changing macros.

- ③ Input function is Level sensed.
④ Input function is Edge sensed.
⑤ Input function is Edge sensed when using StartP/StopP start logic.

Table 18. Digital Input—P2.2, continued

Code	Parameter	Min.	Max.	Unit	Default	ID	Note
P2.2.2 ②⑤	IO Terminal 1 Start Signal 1				2	190	0 = DigIN:NormallyOpen 1 = DigIN:NormallyClose 2 = DigIN: 1 3 = DigIN: 2 4 = DigIN: 3 5 = DigIN: 4 6 = DigIN: 5 7 = DigIN: 6 8 = DigIN: 7 9 = DigIN: 8 10 = DigIN: A: IO1: 1 11 = DigIN: A: IO1: 2 12 = DigIN: A: IO1: 3 13 = DigIN: A: IO5: 1 14 = DigIN: A: IO5: 2 15 = DigIN: A: IO5: 3 16 = DigIN: A: IO5: 4 17 = DigIN: A: IO5: 5 18 = DigIN: A: IO5: 6 19 = DigIN: B: IO1: 1 20 = DigIN: B: IO1: 2 21 = DigIN: B: IO1: 3 22 = DigIN: B: IO5: 1 23 = DigIN: B: IO5: 2 24 = DigIN: B: IO5: 3 25 = DigIN: B: IO5: 4 26 = DigIN: B: IO5: 5 27 = DigIN: B: IO5: 6 31 = RO1 Function 32 = RO2 Function 33 = RO3 Function 34 = Virtual RO1 Function 35 = Virtual RO2 Function
P2.2.3 ②⑤	IO Terminal 1 Start Signal 2				3	191	See Par ID 190
P2.2.4 ① ②	IO Terminal 2 Start Stop Logic				0	2206	See Par ID 143
P2.2.5 ②⑤	IO Terminal 2 Start Signal 1				2	2207	See Par ID 190
P2.2.6 ②⑤	IO Terminal 2 Start Signal 2				3	2208	See Par ID 190
P2.2.7 ①②	Thermistor Input Select				0	881	0 = Digital Input 1 = Thermistor Input
P2.2.8 ②③	Reverse				0	198	See Par ID 190
P2.2.9 ②③	Ext. Fault 1 NO				4	192	See Par ID 190
P2.2.10 ②③	Ext. Fault 1 NC				1	193	See Par ID 190
P2.2.11 ②	Ext. Fault 1 Text				0	2297	0 = External Fault 1 = Vibration Cut out 2 = High Motor temp 3 = Low Pressure 4 = High Pressure 5 = Low Water 6 = Damper Interlock 7 = Run Enable 8 = Freeze Stat Trip 9 = Smoke Detect 10 = Seal Leakage 11 = Rod Breakage
P2.2.12 ②③	Ext. Fault 2 NO				0	2293	See Par ID 190

Notes

- ① Parameter value can only be changed after the drive has stopped.
② Parameter value will be set to be default when changing macros.

③ Input function is Level sensed.

④ Input function is Edge sensed.

⑤ Input function is Edge sensed when using StartP/StopP start logic.

Step 5—Standard Parameter List

Table 18. Digital Input—P2.2, continued

Code	Parameter	Min.	Max.	Unit	Default	ID	Note
P2.2.13 ②③	Ext. Fault 2 NC				1	2294	See Par ID 190
P2.2.14 ②	Ext. Fault 2 Text				1	2298	See Par ID 2297
P2.2.15 ②③	Ext. Fault 3 NO				0	2295	See Par ID 190
P2.2.16 ②③	Ext. Fault 3 NC				1	2296	See Par ID 190
P2.2.17 ②	Ext. Fault 3 Text				2	2299	See Par ID 2297
P2.2.18 ②④	Fault Reset				5	200	See Par ID 190
P2.2.19 ②③	Run Enable				1	194	See Par ID 190
P2.2.20 ②③	Preset Speed B0				6	205	See Par ID 190
P2.2.21 ②③	Preset Speed B1				0	206	See Par ID 190
P2.2.22 ②③	Preset Speed B2				0	207	See Par ID 190
P2.2.23 ②③	Jog Enable				0	199	See Par ID 190
P2.2.24 ②③	Accel/Decel Time Set				0	195	See Par ID 190
P2.2.25 ②③	Accel/Decel Prohibit				0	201	See Par ID 190
P2.2.26 ②④	No Access To Param				0	215	See Par ID 190
P2.2.27 ②③	Auto Control				9	196	See Par ID 190
P2.2.28 ②③	Hand Control				0	197	See Par ID 190
P2.2.29 ②③	Auto 1/2 Select				0	209	See Par ID 190
P2.2.30 ②③	HOA On/Off				1	2395	See Par ID 190
P2.2.32 ②④	Parameter Set1/2 Sel				0	2312	See Par ID 190
P2.2.33 ②③	AI Ref Source Select				0	208	See Par ID 190
P2.2.34 ②④	Bypass Start				8	218	See Par ID 190
P2.2.35 ②③	Bypass Overload				0	1246	See Par ID 190
P2.2.40 ②③	DC Brake Active				0	202	See Par ID 190
P2.2.42 ②③	Fire Mode				7	220	See Par ID 190
P2.2.43 ②③	Fire Mode Ref 1/2 Select				0	221	See Par ID 190
P2.2.44 ②③	Fire Mode Reverse				0	2119	See Par ID 190

Table 19. Preset Speed—P2.3

Code	Parameter	Min.	Max.	Unit	Default	ID	Note
P2.3.1 ②	Preset Speed 1	0.00	See Par ID 102	Hz	5.00	105	
P2.3.2 ②	Preset Speed 2	0.00	See Par ID 102	Hz	10.00	106	
P2.3.3 ②	Preset Speed 3	0.00	See Par ID 102	Hz	15.00	118	
P2.3.4 ②	Preset Speed 4	0.00	See Par ID 102	Hz	20.00	119	
P2.3.5 ②	Preset Speed 5	0.00	See Par ID 102	Hz	25.00	120	
P2.3.6 ②	Preset Speed 6	0.00	See Par ID 102	Hz	30.00	121	
P2.3.7 ②	Preset Speed 7	0.00	See Par ID 102	Hz	35.00	122	
P2.3.8 ②	Jog Reference	See Par ID 101	See Par ID 102	Hz	0.00	117	

Notes

- ① Parameter value can only be changed after the drive has stopped.
- ② Parameter value will be set to be default when changing macros.

- ③ Input function is Level sensed.
- ④ Input function is Edge sensed.
- ⑤ Input function is Edge sensed when using StartP/StopP start logic.

Table 20. AI1 Settings—P2.4

Code	Parameter	Min.	Max.	Unit	Default	ID	Note
P2.4.1	AI1 Mode				1	222	0 = 0–20 mA 1 = 0–10 V
P2.4.2 ②	AI1 Signal Range				0	175	0 = 0–100%/0–20 mA/0–10 V 1 = 20–100%/4–20 mA/2–10 V 2 = Customized
P2.4.3 ②	AI1 Custom Min	0.00	See Par ID 177	%	0.00	176	
P2.4.4 ②	AI1 Custom Max	See Par ID 176	100.00	%	100.00	177	
P2.4.5 ②	AI1 Filter Time	0.00	10.00	s	0.10	174	
P2.4.6 ②	AI1 Signal Invert				0	181	0 = Not Inverted 1 = Inverted

Table 21. AI2 Settings—P2.5

Code	Parameter	Min.	Max.	Unit	Default	ID	Note
P2.5.1	AI2 Mode				0	223	0 = 0–20 mA 1 = 0–10 V 2 = -10– +10 V
P2.5.2 ②	AI2 Signal Range				1	183	0 = 0–100%/0–20 mA/ 0–10 V/-10–10 V 1 = 20–100%/4–20 mA/ 2–10 V/-6–10 V 2 = Customized
P2.5.3 ②	AI2 Custom Min	0.00	See Par ID 185	%	0.00	184	
P2.5.4 ②	AI2 Custom Max	See Par ID 184	100.00	%	100.00	185	
P2.5.5 ②	AI2 Filter Time	0.00	10.00	s	0.10	182	
P2.5.6 ②	AI2 Signal Invert				0	189	See Par ID 181

Table 22. Digital Output—P3.1

Code	Parameter	Min.	Max.	Unit	Default	ID	Note
P3.1.1 ②	DO1 Function				1	151	0 = Not Used 1 = Ready 2 = Run 3 = Fault 4 = Fault Invert 5 = Warning 6 = Reversed 7 = At Speed 8 = Zero Frequency 9 = Freq Limit 1 Superv 10 = Freq Limit 2 Superv 13 = OverHeat Fault 14 = OverCurrent Regular 15 = OverVoltage Regular 16 = UnderVoltage Regular 17 = 4mA Ref Fault/Warning 20 = Torq Limit Superv 21 = Ref Limit Superv 22 = Control from I/O 23 = Un-Requested Rotation Direction 24 = Thermistor Fault Output

Notes

- ① Parameter value can only be changed after the drive has stopped.
② Parameter value will be set to be default when changing macros.

③ Input function is Level sensed.

④ Input function is Edge sensed.

⑤ Input function is Edge sensed when using StartP/StopP start logic.

Step 5—Standard Parameter List

Table 22. Digital Output—P3.1, continued

Code	Parameter	Min.	Max.	Unit	Default	ID	Note
P3.1.1 ②, continued	DO1 Function				1	151	25 = Fire Mode 26 = In Bypass Mode 27 = Ext Fault/Warning 28 = Auto Control 29 = Jog Speed Select 30 = Motor Therm Protection 31 = FB Digital Input 1 32 = FB Digital Input 2 33 = FB Digital Input 3 34 = FB Digital Input 4 40 = Power Limit Superv 41 = Temp Limit Superv 42 = Analog Input Superv 51 = Motor Current 1 Supv 52 = Motor Current 2 Supv 53 = Second AI Limit Supv 54 = DC Charge Switch Close 55 = Preheat Active 56 = Cold Weather Active 58 = 2th Stage Ramp Frequency Active 59 = STO Fault Output 60 = Run Bypass/Drive 61 = Bypass Overload 62 = Bypass Run
P3.1.2 ②	RO1 Function				62	152	See Par ID 151
P3.1.3 ②	RO1 On Delay	0.0	320.0	s	0.0	2112	
P3.1.4 ②	RO1 Off Delay	0.0	320.0	s	0.0	2113	
P3.1.5 ②	RO2 Function				2	153	See Par ID 151
P3.1.6 ②	RO2 On Delay	0.0	320.0	s	0.0	2114	
P3.1.7 ②	RO2 Off Delay	0.0	320.0	s	0.0	2115	
P3.1.8 ②	RO3 Function				3	538	See Par ID 151
P3.1.9 ②	RO3 On Delay	0.0	320.0	s	0.0	2116	
P3.1.10 ②	RO3 Off Delay	0.0	320.0	s	0.0	2117	
P3.1.11 ②	RO3 Reverse				0	2118	0 = No 1 = Yes
P3.1.12 ②	Virtual RO1 Function				0	2463	See Par ID 151
P3.1.13 ②	Virtual RO2 Function				0	2464	See Par ID 151

Table 23. Supervisions—P3.2

Code	Parameter	Min.	Max.	Unit	Default	ID	Note
P3.2.1 ②	Freq Limit 1 Supv				0	154	0 = No Limit 1 = Low Limit Superv 2 = High Limit Superv
P3.2.2 ②	Freq Limit 1 Supv Val	0.00	See Par ID 102	Hz	0.00	155	
P3.2.3 ②	Freq Limit 1 Supv Hyst	0.10	1.00	Hz	0.10	2200	
P3.2.4 ②	Freq Limit 2 Supv				0	157	See Par ID 154
P3.2.5 ②	Freq Limit 2 Supv Val	0.00	See Par ID 102	Hz	0.00	158	
P3.2.6 ②	Freq Limit 2 Supv Hyst	0.10	1.00	Hz	0.10	2201	
P3.2.7 ②	Torque Limit Supv				0	159	See Par ID 154

Notes

- ① Parameter value can only be changed after the drive has stopped.
 ② Parameter value will be set to be default when changing macros.

- ③ Input function is Level sensed.
 ④ Input function is Edge sensed.
 ⑤ Input function is Edge sensed when using StartP/StopP start logic.

Table 23. Supervisions—P3.2, continued

Code	Parameter	Min.	Max.	Unit	Default	ID	Note
P3.2.8 ②	Torque Limit Supv Val	-1000.0	1000.0	%	100.0	160	
P3.2.9 ②	Torque Limit Supv Hyst	1.0	5.0	%	1.0	2202	
P3.2.10 ②	Ref Limit Supv				0	161	See Par ID 154
P3.2.11 ②	Ref Limit Supv Val	0.00	See Par ID 102	Hz	0.00	162	
P3.2.12 ②	Ref Limit Supv Hyst	0.10	1.00	Hz	0.10	2203	
P3.2.13 ②	Temp Limit Supv				0	165	See Par ID 154
P3.2.14 ②	Temp Limit Supv Val	-10.0	75.0	°C	40.0	166	
P3.2.15 ②	Temp Limit Supv Hyst	1.0	10.0	°C	1.0	2204	
P3.2.16 ②	Power Limit Supv				0	167	See Par ID 154
P3.2.17 ②	Power Limit Supv Val	-200.0	200.0	%	0.0	168	
P3.2.18 ②	Power Limit Supv Hyst	0.1	10.0	%	0.1	2205	
P3.2.19 ②	AI Supv Select				0	170	0 = AI1 1 = AI2
P3.2.20 ②	AI Limit Supv				0	171	See Par ID 154
P3.2.21 ②	AI Limit Supv Val	0.00	100.00	%	0.00	172	
P3.2.22 ②	AI Supv Hyst	1.00	10.00	%	1.00	2198	
P3.2.23 ②	Motor Current 1 Supv				0	2189	See Par ID 154
P3.2.24 ②	Motor Current 1 Supv Value	0.0	DriveNomCurr CT*2	A	DriveNomCurrCT	2190	
P3.2.25 ②	Motor Current 1 Supv Hyst	0.1	1.0	A	0.1	2196	
P3.2.26 ②	Motor Current 2 Supv				0	2191	See Par ID 154
P3.2.27 ②	Motor Current 2 Supv Value	0.0	DriveNomCurr CT*2	A	DriveNomCurrCT	2192	
P3.2.28 ②	Motor Current 2 Supv Hyst	0.1	1.0	A	0.1	2197	
P3.2.29 ②	Second AI Supv Select				0	2193	See Par ID 170
P3.2.30 ②	Second AI Limit Supv				0	2194	See Par ID 154
P3.2.31 ②	Second AI Limit Supv Val	0.00	100.00	%	0.00	2195	
P3.2.32 ②	Second AI Supv Hyst	1.00	10.00	%	1.00	2199	

Notes

- ① Parameter value can only be changed after the drive has stopped.
 ② Parameter value will be set to be default when changing macros.

③ Input function is Level sensed.

④ Input function is Edge sensed.

⑤ Input function is Edge sensed when using StartP/StopP start logic.

Step 5—Standard Parameter List

Table 24. Analog Output 1—P3.3

Code	Parameter	Min.	Max.	Unit	Default	ID	Note
P3.3.1 ②	AO1 Mode				0	227	See Par ID 222
P3.3.2 ②	AO1 Function				1	146	0 = Not Used 1 = Output Frequency 2 = Freq Reference 3 = Motor Speed (0–Nom) 4 = Motor Current (0–Nom) 5 = Motor Torque (0–Nom) 6 = Motor Power (0–Nom) 7 = Motor Voltage (0–Nom) 8 = DC-Bus Voltage 19 = AI1 20 = AI2 21 = Output Freq (-2+2N) 22 = Motor Torque (-2+2N) 23 = Motor Power (-2+2N) 24 = PT100 Temperature 33 = SlotA PT100 Temp Channel 1 34 = SlotA PT100 Temp Channel 2 35 = SlotA PT100 Temp Channel 3 36 = SlotB PT100 Temp Channel 1 37 = SlotB PT100 Temp Channel 2 38 = SlotB PT100 Temp Channel 3 39 = User Defined Output 40 = Motor Current (-2+2N)
P3.3.3 ②	AO1 Minimum				1	149	0 = 0 V / 0 mA 1 = 2 V / 4 mA
P3.3.4 ②	AO1 Filter Time	0.00	10.00	s	1.00	147	
P3.3.5 ②	AO1 Scale	10	1000	%	100	150	
P3.3.6 ②	AO1 Inversion				0	148	See Par ID 181
P3.3.7 ②	AO1 Offset	-100.00	100.00	%	0.00	173	

Table 25. Analog Output 2—P3.4

Code	Parameter	Min.	Max.	Unit	Default	ID	Note
P3.4.1 ②	AO2 Mode				0	228	See Par ID 222
P3.4.2 ②	AO2 Function				4	229	See Par ID 146
P3.4.3 ②	AO2 Minimum				1	232	See Par ID 149
P3.4.4 ②	AO2 Filter Time	0.00	10.00	s	1.00	230	
P3.4.5 ②	AO2 Scale	10	1000	%	100	233	
P3.4.6 ②	AO2 Inversion				0	231	See Par ID 181
P3.4.7 ②	AO2 Offset	-100.00	100.00	%	0.00	234	

Notes

- ① Parameter value can only be changed after the drive has stopped.
- ② Parameter value will be set to be default when changing macros.

- ③ Input function is Level sensed.
- ④ Input function is Edge sensed.
- ⑤ Input function is Edge sensed when using StartP/StopP start logic.

Drive Control

Table 26. Basic Setting—P4.1

Code	Parameter	Min.	Max.	Unit	Default	ID	Note
P4.1.1 ②	Keypad Reference	See Par ID 101	See Par ID 102	Hz	0.00	141	
P4.1.2 ②	Keypad Direction				0	116	0 = Forward 1 = Reverse
P4.1.3 ②	Keypad Stop				1	114	0 = Enabled-Keypad Operation 1 = Always Enabled
P4.1.4 ②	Hand Key Enable				0	1724	0 = Enabled 1 = Disabled
P4.1.5 ①	Reverse Enable				0	1679	0 = Disabled 1 = Enabled
P4.1.6	Change PhaseSequence Motor				0	2515	0 = Change Disable 1 = Change Enable
P4.1.7 ②	Power Up HOA Select				0	1685	0 = Hold Last 1 = Hand Control 2 = Auto control 3 = Off
P4.1.9 ②	Run Delay Time	0	32500	s	0	2423	
P4.1.10 ②	Start Mode				0	252	0 = Ramp 1 = Flying Start
P4.1.11 ②	Stop Mode				0	253	0 = Coasting 1 = Ramp
P4.1.12 ②	Ramp 1 Shape	0.0	10.0	s	0.0	247	
P4.1.13 ②	Ramp 2 Shape	0.0	10.0	s	0.0	248	
P4.1.14 ②	Accel Time 2	0.1	3000.0	s	10.0	249	
P4.1.15 ②	Decel Time 2	0.1	3000.0	s	10.0	250	
P4.1.16 ②	Power Loss Function				0	267	See Par ID 1679
P4.1.17 ②	Power Loss Time	0.3	5.0	s	2.0	268	
P4.1.18 ①②	2nd Stage Ramp Frequency	See Par ID 101	See Par ID 102	Hz	30.00	2444	

Table 27. Brake—P4.2

Code	Parameter	Min.	Max.	Unit	Default	ID	Note
P4.2.1 ①②	DC-Brake Current	DriveNomCurr CT*15/100	DriveNomCurr CT*15/10	A	DriveNomCurr CT*1/2	254	
P4.2.2 ①②	Start DC-Brake Time	0.00	600.00	s	0.00	263	
P4.2.3 ①②	Stop DC-Brake Frequency	0.10	10.00	Hz	1.50	262	
P4.2.4 ①②	Stop DC-Brake Time	0.00	600.00	s	0.00	255	
P4.2.5 ①②	Brake Chopper Define				0	251	0 = Disabled 1 = B(Run) T(Rdy) 2 = External 3 = B(Rdy) T(Rdy) 4 = B(Run) T(No)
P4.2.6 ①②	Flux Brake				0	266	0 = Off 1 = On
P4.2.7 ①②	Flux Brake Current	ActiveMotor NomCurr*1/10	See Par ID 107	A	ActiveMotorNom Curr*1/2	265	

Notes

- ① Parameter value can only be changed after the drive has stopped.
 ② Parameter value will be set to be default when changing macros.

③ Input function is Level sensed.

④ Input function is Edge sensed.

⑤ Input function is Edge sensed when using StartP/StopP start logic.

Step 5—Standard Parameter List

Table 28. Skip Frequency—P4.3

Code	Parameter	Min.	Max.	Unit	Default	ID	Note
P4.3.1 ②	Skip Range Ramp Factor	0.1	10.0		1.0	264	
P4.3.2 ②	Skip F1 Low Limit	0.00	See Par ID 257	Hz	0.00	256	
P4.3.3 ②	Skip F1 High Limit	See Par ID 256	400.00	Hz	0.00	257	
P4.3.4 ②	Skip F2 Low Limit	0.00	See Par ID 259	Hz	0.00	258	
P4.3.5 ②	Skip F2 High Limit	See Par ID 258	400.00	Hz	0.00	259	
P4.3.6 ②	Skip F3 Low Limit	0.00	See Par ID 261	Hz	0.00	260	
P4.3.7 ②	Skip F3 High Limit	See Par ID 260	400.00	Hz	0.00	261	

Table 29. Energy Savings Calc—P4.4

Code	Parameter	Min.	Max.	Unit	Default	ID	Note
P4.4.1 ②	Currency				0	2122	0 = \$ 1 = £ 2 = € 3 = ¥ 4 = Rs 5 = R\$ 6 = Fr 7 = kr
P4.4.2 ②	Energy Cost			Varies	0.00	2123	
P4.4.3 ②	Data Type				0	2124	0 = Cumulative 1 = Daily Avg 2 = Weekly Avg 3 = Monthly Avg 4 = Yearly Avg
P4.4.4	Energy Savings Reset					2125	0 = Not Reset 1 = Reset

Motor Control

Table 30. Basic Setting—P5.1

Code	Parameter	Min.	Max.	Unit	Default	ID	Note
P5.1.1 ①②	Motor Control Mode				0	287	0 = Freq Control 1 = Speed Control
P5.1.2 ①	Current Limit	DriveNomCurr CT*1/10	DriveNomCurr CT*2	A	DriveNomCurrCT*2	107	
P5.1.3 ①②	V/Hz Optimization				0	109	See Par ID 1679
P5.1.4 ①②	V/Hz Ratio				3	108	0 = Linear 1 = Squared 2 = Programmable 3 = Linear + Flux Optimization
P5.1.5 ①②	Field Weakening Point	8.00	400.00	Hz	FieldWeakPointMFG	289	
P5.1.6 ①②	Voltage at FWP	10.00	200.00	%	100.00	290	
P5.1.7 ①②	V/Hz Mid Frequency	0.00	See Par ID 289	Hz	VHzCurveMidFreq MFG	291	
P5.1.8 ①②	V/Hz Mid Voltage	0.00	100.00	%	100.00	292	
P5.1.9 ①②	Zero Frequency Voltage	0.00	40.00	%	0.00	293	

Notes

- ① Parameter value can only be changed after the drive has stopped.
② Parameter value will be set to be default when changing macros.

- ③ Input function is Level sensed.
④ Input function is Edge sensed.
⑤ Input function is Edge sensed when using StartP/StopP start logic.

Table 30. Basic Setting—P5.1, continued

Code	Parameter	Min.	Max.	Unit	Default	ID	Note
P5.1.10 ②	Switching Frequency	MinSwitchFreq	MaxSwitchFreq	kHz	DefaultSwitchFreqCT	2522	
P5.1.11 ②	Sine Filter Enable				0	1665	See Par ID 1679
P5.1.12 ① ②	OverVoltage Control				1	294	See Par ID 1679

Protections

Table 31. Motor—P6.1

Code	Parameter	Min.	Max.	Unit	Default	ID	Note
P6.1.1 ① ②	Output Phase Fault				2	308	0 = No Action 1 = Warning 2 = Fault 3 = Fault, Coast
P6.1.2 ① ②	Ground Fault				2	309	See Par ID 308
P6.1.3 ②	Ground Fault Limit	0	30	%	15	2158	
P6.1.4 ① ②	Motor Thermal Protection				2	310	See Par ID 308
P6.1.5 ②	Motor Thermal F0 Current	0.0	150.0	%	40.0	311	
P6.1.6 ②	Motor Thermal Time	1	200	min	12	312	
P6.1.7 ① ②	Stall Protection				0	313	See Par ID 308
P6.1.8 ②	Stall Current Limit	0.1	ActiveMotorNomCurr*2	A	ActiveMotorNomCurr*13/10	314	
P6.1.9 ②	Stall Time Limit	1.0	120.0	s	15.0	315	
P6.1.10 ②	Stall Frequency Limit	1.00	See Par ID 102	Hz	25.00	316	
P6.1.11 ① ②	Underload Protection				0	317	See Par ID 308
P6.1.12 ②	Underload Fnom Torque	10.0	150.0	%	50.0	318	
P6.1.13 ②	Underload F0 Torque	5.0	150.0	%	10.0	319	
P6.1.14 ②	Underload Time Limit	2.00	600.00	s	20.00	320	
P6.1.15 ① ②	Thermistor Fault Response				2	333	See Par ID 308
P6.1.16 ① ②	PT100 Fault Response				2	337	See Par ID 308
P6.1.17 ②	Preheat Mode				0	2159	See Par ID 1679

Notes

- ① Parameter value can only be changed after the drive has stopped.
 ② Parameter value will be set to be default when changing macros.

- ③ Input function is Level sensed.
 ④ Input function is Edge sensed.
 ⑤ Input function is Edge sensed when using StartP/StopP start logic.

Step 5—Standard Parameter List

Table 31. Motor—P6.1, continued

Code	Parameter	Min.	Max.	Unit	Default	ID	Note
P6.1.18 ②	Preheat Control Source				31	2160	0 = DigIN:NormallyOpen 1 = DigIN:NormallyClose 2 = DigIN: 1 3 = DigIN: 2 4 = DigIN: 3 5 = DigIN: 4 6 = DigIN: 5 7 = DigIN: 6 8 = DigIN: 7 9 = DigIN: 8 10 = DigIN: A: IO1: 1 11 = DigIN: A: IO1: 2 12 = DigIN: A: IO1: 3 13 = DigIN: A: IO5: 1 14 = DigIN: A: IO5: 2 15 = DigIN: A: IO5: 3 16 = DigIN: A: IO5: 4 17 = DigIN: A: IO5: 5 18 = DigIN: A: IO5: 6 19 = DigIN: B: IO1: 1 20 = DigIN: B: IO1: 2 21 = DigIN: B: IO1: 3 22 = DigIN: B: IO5: 1 23 = DigIN: B: IO5: 2 24 = DigIN: B: IO5: 3 25 = DigIN: B: IO5: 4 26 = DigIN: B: IO5: 5 27 = DigIN: B: IO5: 6 28 = Time Channel 1 29 = Time Channel 2 30 = Time Channel 3 31 = Drive Temperature 32 = SlotA PT100 Temp Channel 1 33 = SlotA PT100 Temp Channel 2 34 = SlotA PT100 Temp Channel 3 35 = SlotA Max PT100 Temp 36 = SlotB PT100 Temp Channel 1 37 = SlotB PT100 Temp Channel 2 38 = SlotB PT100 Temp Channel 3 39 = SlotB Max PT100 Temp 40 = SlotA and SlotB Max PT100 Temp
P6.1.19 ②	Preheat Enter Temp	0.0	19.9	°C	10.0	2161	
P6.1.20 ②	Preheat Quit Temp	20.0	40.0	°C	20.0	2162	
P6.1.21 ②	Preheat Output Volt	0.0	20.0	%	2.0	2163	

Notes

- ① Parameter value can only be changed after the drive has stopped.
- ② Parameter value will be set to be default when changing macros.

- ③ Input function is Level sensed.
- ④ Input function is Edge sensed.
- ⑤ Input function is Edge sensed when using StartP/StopP start logic.

Table 32. Drive—P6.2

Code	Parameter	Min.	Max.	Unit	Default	ID	Note
P6.2.1 ②	Line Start Lockout				2	750	0 = Disabled, No Change 1 = Enable, No Change 2 = Disabled, Changed 3 = Enable, Changed
P6.2.2 ②	Fault Reset Start				0	2483	0 = Start/Stop After Fault Reset 1 = Restart After Fault Reset
P6.2.3 ① ②	4mA Input Fault				0	306	0 = No Action 1 = Warning 2 = Warning: Previous Freq 3 = Warning: Preset Freq 4 = Fault 5 = Fault, Coast
P6.2.4 ① ②	4mA Fault Frequency	0.00	See Par ID 102	Hz	0.00	331	
P6.2.5 ① ②	External Fault				2	307	See Par ID 308
P6.2.6 ① ②	Input Phase Fault				2	332	See Par ID 308
P6.2.7 ① ②	Uvolt Fault Response				2	330	See Par ID 308
P6.2.8 ① ②	Unit Under Temp Prot				2	1564	See Par ID 308
P6.2.9 ① ②	RTC Fault				1	955	See Par ID 308
P6.2.10 ① ②	Replace Battery Fault Response				1	1256	See Par ID 308
P6.2.11 ① ②	Replace Fan Fault Response				1	1257	See Par ID 308
P6.2.12 ②	Cold Weather Mode				0	2126	See Par ID 1679
P6.2.13 ②	Cold Weather Volt. Level	0.0	20.0	%	2.0	2127	
P6.2.14 ②	Cold Weather Time Out	0	10	min	3	2128	
P6.2.15	Cold Weather Password					2129	
P6.2.16	Under Temp Fault Override					2130	See Par ID 2118
P6.2.17 ②	STO Fault Response				2	2427	0 = No Action 1 = Warning 2 = Fault

Table 33. Communication—P6.3

Code	Parameter	Min.	Max.	Unit	Default	ID	Note
P6.3.1 ① ②	Fieldbus Fault Response				2	334	0 = No Action 1 = Warning 2 = Fault 3 = Fault, Coast 4 = Warning, Coast
P6.3.2 ① ②	OPTCard Fault Response				2	335	See Par ID 308
P6.3.3 ① ②	IP Address Confliction Resp				1	1678	See Par ID 308
P6.3.4 ① ②	Keypad Comm Fault Response				2	2157	See Par ID 308

Notes

- ① Parameter value can only be changed after the drive has stopped.
② Parameter value will be set to be default when changing macros.

③ Input function is Level sensed.

④ Input function is Edge sensed.

⑤ Input function is Edge sensed when using StartP/StopP start logic.

Step 5—Standard Parameter List

Table 34. Auto Restart—P6.4

Code	Parameter	Min.	Max.	Unit	Default	ID	Note
P6.4.1 ②	AR Wait Time	1.00	300.00	s	1.00	321	
P6.4.2 ②	AR Trail Time	0.00	600.00	s	30.00	322	
P6.4.3 ②	AR Start Function				0	323	0 = Flying Start 1 = Ramp
P6.4.4 ②	Undervoltage Attempts	0	10		1	324	
P6.4.5 ②	OverVoltage Attempts	0	10		1	325	
P6.4.6 ②	OverCurrent Attempts	0	3		0	326	
P6.4.7 ②	4mA Fault Attempts	0	10		0	327	
P6.4.8 ②	Motor Temp Fault Attempts	0	10		0	329	
P6.4.9 ②	External Fault Attempts	0	10		0	328	
P6.4.10 ②	Underload Attempts	0	10		0	336	

Table 35. Fire Mode—P9

Code	Parameter	Min.	Max.	Unit	Default	ID	Note
P9.1 ① ②	Fire Mode Function				0	535	0 = Closing Contact 1 = Opening Contact
P9.2 ① ②	Fire Mode Ref Select Function				0	536	0 = Fire Mode Min Frequency 1 = Fire Mode Ref 2 = Fieldbus Ref 3 = AI1 4 = AI2 5 = AI1 + AI2
P9.3 ②	Fire Mode Min Frequency	See Par ID 101	See Par ID 102	Hz	15.00	537	
P9.4 ②	Fire Mode Freq Ref 1	0.0	100.0	%	75.0	565	
P9.5 ②	Fire Mode Freq Ref 2	0.0	100.0	%	100.0	564	
P9.6	Fire Mode Test Enable					2443	See Par ID 1679

Notes

- ① Parameter value can only be changed after the drive has stopped.
- ② Parameter value will be set to be default when changing macros.

- ③ Input function is Level sensed.
- ④ Input function is Edge sensed.
- ⑤ Input function is Edge sensed when using StartP/StopP start logic.

Bypass

Table 36. Basic Setting—P10.1

Code	Parameter	Min.	Max.	Unit	Default	ID	Note
P10.1.1 ①②	Bypass Enable				1	1418	See Par ID 1679
P10.1.2 ①②	Bypass Start Delay	1	32765	s	1	544	
P10.1.3 ①②	Auto Bypass				1	542	See Par ID 1679
P10.1.4 ①②	Auto Bypass Delay	0	32765	s	10	543	
P10.1.5 ①②	OverCurrent Bypass Enable				0	547	See Par ID 1679
P10.1.6 ①②	IGBT Fault Bypass Enable				0	546	See Par ID 1679
P10.1.7 ①②	4mA Fault Bypass Enable				0	548	See Par ID 1679
P10.1.8 ①②	UnderVoltage Bypass Enable				0	545	See Par ID 1679
P10.1.9 ①②	OverVoltage Bypass Enable				0	549	See Par ID 1679
P10.1.10 ①②	Motor OverTemp Bypass Enable				0	1698	See Par ID 1679
P10.1.11 ①②	UnderLoad Bypass Enable				0	1699	See Par ID 1679
P10.1.12 ①②	External Bypass Enable				0	1700	See Par ID 1679
P10.1.13 ①②	Charge Switch Fault Bypass Enable				0	1701	See Par ID 1679
P10.1.14 ①②	Saturation Trip Fault Bypass Enable				0	1702	See Par ID 1679
P10.1.15 ①②	Under Temp Fault Bypass Enable				0	1703	See Par ID 1679
P10.1.16 ①②	EEPROM Fault Bypass Enable				0	1704	See Par ID 1679
P10.1.17 ①②	FRAM Fault Bypass Enable				0	1705	See Par ID 1679
P10.1.18 ①②	Watchdog Fault Bypass Enable				0	1706	See Par ID 1679
P10.1.19 ①②	Fan Cooling Fault Bypass Enable				0	1707	See Par ID 1679
P10.1.20 ①②	Keypad Com Fault Bypass Enable				0	1708	0 = Disabled 2 = Enabled
P10.1.21 ①②	Option Card Fault Bypass Enable				0	1709	See Par ID 1679
P10.1.22 ①②	RTC Clock Fault Bypass Enable				0	1710	See Par ID 1679
P10.1.23 ①②	Ctrl Board OverTemp Fault Bypass Enable				0	1711	See Par ID 1679
P10.1.24 ①②	Speed Search Start Fault Bypass Enable				0	1712	See Par ID 1679
P10.1.25 ①②	Fieldbus Fault Bypass Enable				0	1713	See Par ID 1679

Notes

- ① Parameter value can only be changed after the drive has stopped.
 ② Parameter value will be set to be default when changing macros.

③ Input function is Level sensed.

④ Input function is Edge sensed.

⑤ Input function is Edge sensed when using StartP/StopP start logic.

Communication

Table 37. FB Process Data Input Sel—P12.1

Code	Parameter	Min.	Max.	Unit	Default	ID	Note
P12.1.1 ②	FB Process Data Input 1 Sel	0	2560		0	2533	
P12.1.2 ②	FB Process Data Input 2 Sel	0	2560		2542	2534	
P12.1.3 ②	FB Process Data Input 3 Sel	0	2560		2550	2535	
P12.1.4 ②	FB Process Data Input 4 Sel	0	2560		103	2536	
P12.1.5 ②	FB Process Data Input 5 Sel	0	2560		104	2537	
P12.1.6 ②	FB Process Data Input 6 Sel	0	2560		107	2538	
P12.1.7 ②	FB Process Data Input 7 Sel	0	2560		0	2539	
P12.1.8 ②	FB Process Data Input 8 Sel	0	2560		0	2540	

Table 38. FB Process Data Output Sel—P12.2

Code	Parameter	Min.	Max.	Unit	Default	ID	Note
P12.2.1 ②	FB Process Data Output 1 Sel				1	1556	
P12.2.2 ②	FB Process Data Output 2 Sel				2	1557	
P12.2.3 ②	FB Process Data Output 3 Sel				3	1558	
P12.2.4 ②	FB Process Data Output 4 Sel				4	1559	
P12.2.5 ②	FB Process Data Output 5 Sel				5	1560	
P12.2.6 ②	FB Process Data Output 6 Sel				6	1561	
P12.2.7 ②	FB Process Data Output 7 Sel				7	1562	
P12.2.8 ②	FB Process Data Output 8 Sel				28	1563	

Notes

- ① Parameter value can only be changed after the drive has stopped.
- ② Parameter value will be set to be default when changing macros.

- ③ Input function is Level sensed.
- ④ Input function is Edge sensed.
- ⑤ Input function is Edge sensed when using StartP/StopP start logic.

Table 38. FB Process Data Output Sel—P12.2, continued

Code	Parameter	Min.	Max.	Unit	Default	ID	Note
P12.2.9 ②	Standard Status Word Bit0 Function Select				1	2415	0 = Not Used 1 = Ready 2 = Run 3 = Fault 4 = Fault Invert 5 = Warning 6 = Reversed 7 = At Speed 8 = Zero Frequency 9 = Freq Limit 1 Superv 10 = Freq Limit 2 Superv 13 = OverHeat Fault 14 = OverCurrent Regular 15 = OverVoltage Regular 16 = UnderVoltage Regular 17 = 4mA Ref Fault/Warning 20 = Torq Limit Superv 21 = Ref Limit Superv 22 = Control from I/O 23 = Un-Requested Rotation Direction 24 = Thermistor Fault Output 25 = Fire Mode 26 = In Bypass Mode 27 = Ext Fault/Warning 28 = Auto Control 29 = Jog Speed Select 30 = Motor Therm Protection 31 = FB Digital Input 1 32 = FB Digital Input 2 33 = FB Digital Input 3 34 = FB Digital Input 4 40 = Power Limit Superv 41 = Temp Limit Superv 42 = Analog Input Superv 51 = Motor Current 1 Supv 52 = Motor Current 2 Supv 53 = Second AI Limit Supv 54 = DC Charge Switch Close 55 = Preheat Active 56 = Cold Weather Active 58 = 2th Stage Ramp Frequency Active 59 = STO Fault Output 60 = Run Bypass/Drive 61 = Bypass Overload 62 = Bypass Run
P12.2.10 ②	Standard Status Word Bit1 Function Select				2	2416	See Par ID 2415
P12.2.11 ②	Standard Status Word Bit2 Function Select				3	2417	See Par ID 2415
P12.2.12 ②	Standard Status Word Bit3 Function Select				4	2418	See Par ID 2415
P12.2.13 ②	Standard Status Word Bit4 Function Select				5	2419	See Par ID 2415

Notes

- ① Parameter value can only be changed after the drive has stopped.
② Parameter value will be set to be default when changing macros.

③ Input function is Level sensed.

④ Input function is Edge sensed.

⑤ Input function is Edge sensed when using StartP/StopP start logic.

Step 5—Standard Parameter List

Table 38. FB Process Data Output Sel—P12.2, continued

Code	Parameter	Min.	Max.	Unit	Default	ID	Note
P12.2.14 ②	Standard Status Word Bit5 Function Select				6	2420	See Par ID 2415
P12.2.15 ②	Standard Status Word Bit6 Function Select				7	2421	See Par ID 2415
P12.2.16 ②	Standard Status Word Bit7 Function Select				8	2422	See Par ID 2415

RS-485 Bus

Table 39. Basic Setting—P12.3.1

Code	Parameter	Min.	Max.	Unit	Default	ID	Note
P12.3.1.1 ①	RS485 Comm Set				0	586	0 = Modbus RTU 1 = BACnet MS/TP

Table 40. Modbus RTU—P12.3.2

Code	Parameter	Min.	Max.	Unit	Default	ID	Note
P12.3.2.1 ①	Slave Address	1	247		1	587	
P12.3.2.2 ①	Baud Rate				1	584	0 = 9600 1 = 19200 2 = 38400 3 = 57600 4 = 115200
P12.3.2.3 ①	Parity Type				2	585	0 = None 1 = Odd 2 = Even
P12.3.2.4	Modbus RTU Protocol Status					588	0 = Initial 1 = Stopped 2 = Operational 3 = Faulted
P12.3.2.5	Comm Timeout Modbus RTU 0		60000	ms	10000	593	
P12.3.2.6	Modbus RTU Fault Response				0	2516	0 = in Fieldbus Control 1 = in all Control

Table 41. BACnet MS/TP—P12.3.3

Code	Parameter	Min.	Max.	Unit	Default	ID	Note
P12.3.3.1 ①	MSTP Baud Rate				2	594	0 = 9600 1 = 19200 2 = 38400 3 = 76800 4 = 115200
P12.3.3.2 ①	MSTP Device Address	0	127		1	595	
P12.3.3.3 ①	MSTP Instance Number	0	4194302		0	596	
P12.3.3.4	MSTP Comm Timeout	0	60000	ms	10000	598	
P12.3.3.5	MSTP Protocol Status					599	0 = Stopped 1 = Operational 2 = Faulted

Notes

- ① Parameter value can only be changed after the drive has stopped.
② Parameter value will be set to be default when changing macros.

- ③ Input function is Level sensed.
④ Input function is Edge sensed.
⑤ Input function is Edge sensed when using StartP/StopP start logic.

Table 41. BACnet MS/TP—P12.3.3, continued

Code	Parameter	Min.	Max.	Unit	Default	ID	Note
P12.3.3.6	MSTP Fault Code					600	0 = None 1 = Sole Master 2 = Duplicate MAC ID 3 = Baud rate fault
P12.3.3.7 ②	MSTP Fault Response				0	2526	See Par ID 2516
P12.3.3.8 ①	MSTP Max Master				127	1537	

EtherNet Bus

Table 42. Basic Setting—P12.4.1

Code	Parameter	Min.	Max.	Unit	Default	ID	Note
P12.4.1.1 ①	IP Address Mode				1	1500	0 = Static IP 1 = DHCP with AutoIP
P12.4.1.2	Active IP Address					1507	
P12.4.1.3	Active Subnet Mask					1509	
P12.4.1.4	Active Default Gateway					1511	
P12.4.1.5	MAC Address					1513	
P12.4.1.6 ①	Static IP Address				192.168.1.254	1501	
P12.4.1.7 ①	Static Subnet Mask				255.255.255.0	1503	
P12.4.1.8 ①	Static Default Gateway				192.168.1.1	1505	
P12.4.1.9 ①	Enable BACnetIP				0	1725	See Par ID 1679

Table 43. Modbus TCP—P12.4.2

Code	Parameter	Min.	Max.	Unit	Default	ID	Note
P12.4.2.1	Connection Limit				5	609	
P12.4.2.2	Modbus TCP Unit ID				1	610	
P12.4.2.3	Comm Timeout Modbus TCP 0		60000	ms	10000	611	
P12.4.2.4	Modbus TCP Protocol Status					612	See Par ID 599
P12.4.2.5	Modbus TCP Fault Response				0	2517	See Par ID 2516

Notes

- ① Parameter value can only be changed after the drive has stopped.
② Parameter value will be set to be default when changing macros.

- ③ Input function is Level sensed.
④ Input function is Edge sensed.
⑤ Input function is Edge sensed when using StartP/StopP start logic.

Step 5—Standard Parameter List

Table 44. BACnet IP—P12.4.3

Code	Parameter	Min.	Max.	Unit	Default	ID	Note
P12.4.3.1 ① ②	BACnet IP UDP port number				47808	1733	47808 = BAC0 47809 = BAC1 47810 = BAC2 47811 = BAC3 47812 = BAC4 47813 = BAC5 47814 = BAC6 47815 = BAC7 47816 = BAC8 47817 = BAC9 47818 = BACA 47819 = BACB 47820 = BACC 47821 = BACD 47822 = BACE 47823 = BACF
P12.4.3.2 ②	BACnet IP Foreign Device				0	1734	See Par ID 1679
P12.4.3.3 ②	BACnet IP BBMD IP				0.0.0.0	1735	
P12.4.3.4 ②	BACnet IP BBMD Port				47808	1737	See Par ID 1733
P12.4.3.5 ②	BACnet IP Registration Interval	0	65535		10	1738	
P12.4.3.6 ②	BACnet IP Comm Timeout	0	60000		0	1739	
P12.4.3.7	BACnet IP Protocol Status					1740	See Par ID 599
P12.4.3.8 ②	BACnet IP Fault Behavior				0	1741	See Par ID 2516
P12.4.3.9 ①	BACnetIP Instance Number	0	4194302		0	1742	

System

Table 45. Basic Setting—P13.1

Code	Parameter	Min.	Max.	Unit	Default	ID	Note
P13.1.1	Language				0	340	0 = English 1 = 中文 2 = Deutsch
P13.1.2 ①	Application					142	0 = Basic 1 = PID 2 = Advanced
P13.1.3 ①	Parameter Sets					619	0 = No 1 = Reload Defaults 2 = Reload Set 1 3 = Reload Set 2 4 = Store Set 1 5 = Store Set 2 6 = Reset 7 = Reload Defaults VM
P13.1.4	Up To Keypad					620	See Par ID 2118
P13.1.5 ①	Down From Keypad					621	0 = No 1 = All Parameters 2 = All, No Motor 3 = App Parameters

Notes

- ① Parameter value can only be changed after the drive has stopped.
② Parameter value will be set to be default when changing macros.

- ③ Input function is Level sensed.
④ Input function is Edge sensed.
⑤ Input function is Edge sensed when using StartP/StopP start logic.

Table 45. Basic Setting—P13.1, continued

Code	Parameter	Min.	Max.	Unit	Default	ID	Note
P13.1.6	Parameter Comparison					623	0 = No 1 = Compare with Keypad 2 = Compare with Default 3 = Compare with Set 1 4 = Compare with Set 2
P13.1.7	Password	0	9999		0	624	
P13.1.8	Parameter Lock				0	625	0 = Change Enable 1 = Change Disable
P13.1.9	Multimonitor Set				0	627	See Par ID 625
P13.1.10	Default Page				0	628	0 = None 1 = Main Menu 2 = Multi-Monitor 3 = Favorite Menu 4 = Keypad Reference
P13.1.11	Timeout Time	0	65535	s	30	629	
P13.1.12	Contrast Adjust	5	18		12	630	
P13.1.13	Backlight Time	1	65535	min	10	631	
P13.1.14	Fan Control				2	632	0 = Continuous 1 = Temperature 2 = Run Follow 3 = Calculate IGBT Temp
P13.1.15	Keypad ACK Timeout	200	5000	ms	200	633	
P13.1.16	Keypad Retry Number	1	10		5	634	
P13.1.17	Startup Wizard				0	626	0 = Yes 1 = No
P13.1.18 ②	Jog Softkey Hidden				0	2412	See Par ID 1679
P13.1.19 ②	Reverse Softkey Hidden				0	2413	See Par ID 1679

Notes

- ① Parameter value can only be changed after the drive has stopped.
 ② Parameter value will be set to be default when changing macros.

③ Input function is Level sensed.

④ Input function is Edge sensed.

⑤ Input function is Edge sensed when using StartP/StopP start logic.

Step 5—Standard Parameter List

Table 45. Basic Setting—P13.1, continued

Code	Parameter	Min.	Max.	Unit	Default	ID	Note
P13.1.20 ②	Output Display Unit				45	2424	0 = % 1 = l/min 2 = rpm 3 = ppm 4 = pps 5 = l/s 6 = l/min 7 = l/h 8 = kg/s 9 = kg/min 10 = kg/h 11 = m3/s 12 = m3/min 13 = m3/h 14 = m/s 15 = mbar 16 = bar 17 = Pa 18 = kPa 19 = mVS 20 = kW 21 = °C 22 = GPM 23 = gal/s 24 = gal/min 25 = gal/h 26 = lb/s 27 = lb/min 28 = lb/h 29 = CFM 30 = ft3/s 31 = ft3/min 32 = ft3/h 33 = ft/s 34 = in wg 35 = ft wg 36 = PSI 37 = lb/in2 38 = HP 39 = °C 40 = PA 41 = WC 42 = HG 43 = ft 44 = m 45 = Hz 46 = strokes/min
P13.1.21 ②	Output Display Unit Min	-60000.00	See Par ID 2425	Varies	0.00	2460	
P13.1.22 ②	Output Display Unit Max	See Par ID 2460	60000.00	Varies	MotorNomFreqMFG	2425	

Notes

- ① Parameter value can only be changed after the drive has stopped.
- ② Parameter value will be set to be default when changing macros.

- ③ Input function is Level sensed.
- ④ Input function is Edge sensed.
- ⑤ Input function is Edge sensed when using StartP/StopP start logic.

Table 46. Version Info—P13.2

Code	Parameter	Min.	Max.	Unit	Default	ID	Note
P13.2.1	Keypad Software Version					640	
P13.2.2	Motor Control Software Version					642	
P13.2.3	Application Software Version					644	
P13.2.4	Software Bundle Version					1714	

Table 47. Application Info—P13.3

Code	Parameter	Min.	Max.	Unit	Default	ID	Note
P13.3.1	Brake Chopper					646	See Par ID 2118
P13.3.2	Brake Resistor Status					647	See Par ID 2118
P13.3.3	Serial Number					648	

Table 48. User Info—P13.4

Code	Parameter	Min.	Max.	Unit	Default	ID	Note
P13.4.1	Real Time Clock				0.0.0.1:1:13	566	
P13.4.2	Daylight Saving				0	582	0 = Off 1 = EU 2 = US
P13.4.3	Total MWh Count			Mwh		601	
P13.4.4	Total Power Day Count					603	
P13.4.5	Total Power Hr Count					606	
P13.4.6	Trip MWh Count			Mwh		604	
P13.4.7	Clear Trip MWh Count					635	See Par ID 2125
P13.4.8	Trip Power Day Count					636	
P13.4.9	Trip Power Hr Count					637	
P13.4.10	Clear Trip Power Count					639	See Par ID 2125

Notes

- ① Parameter value can only be changed after the drive has stopped.
 ② Parameter value will be set to be default when changing macros.

- ③ Input function is Level sensed.
 ④ Input function is Edge sensed.
 ⑤ Input function is Edge sensed when using StartP/StopP start logic.

Appendix A—Fault and Warning Codes

Under this menu, you can find Active faults, History faults and Fault codes.

Table 49. Active Faults

Menu	Function	Note
Active Faults	When a fault/faults appear(s), the display with the name and fault time of the fault will be pop. Press DETAIL to see the fault data. The Active Faults submenu shows the list of faults. Select the fault and push DETAIL to see the fault data.	The fault remains active until it is cleared with the Reset button (push for 2s) or with a reset signal from the I/O terminal or Fieldbus. The memory of active faults can store the maximum of 10 faults in the order of appearance.

Table 50. History Faults

Menu	Function	Note
History Faults	10 latest faults are stored in the Fault history, Select the fault and push DETAIL to see the fault data.	The history fault will be stored until it is cleared with the OK button (push for 5s). The memory of active faults can store the maximum of 10 faults in the order of appearance.

Fault Codes and Descriptions

Configurable ☉ = The fault type of this fault is configurable, fault type can be configured as
0 = No Action; 1 = Warning; 2 = Fault; 3= Fault, Coast

Table 51. Fault Codes and Descriptions

Fault Code	Fault Name	Fault Type	Default Fault Type	Possible Cause	Remedy
1	Over Current	Fault		AC drive has detected too high a current (>4*I _H) in the motor cable: <ul style="list-style-type: none"> • Sudden heavy load increase • Short circuit in motor cables • Unsuitable motor 	<ul style="list-style-type: none"> • Check loading • Check motor • Check cables and connections • Make identification run • Check ramp times
2	Over Voltage	Fault		The DC-link voltage has exceeded the limits defined: <ul style="list-style-type: none"> • Too short a deceleration time • Brake chopper is disabled • High overvoltage spikes in supply • Start/Stop sequence too fast 	<ul style="list-style-type: none"> • Make deceleration time longer • Use brake chopper or brake resistor (available as options) • Activate overvoltage controller • Check input voltage
3	Earth Fault	Configurable	Fault	Current measurement has detected that the sum of motor phase current is not zero: <ul style="list-style-type: none"> • Insulation failure in cables or motor 	Check motor cables and motor
5	Charging Switch	Fault		The charging switch is open, when the START command has been given: <ul style="list-style-type: none"> • Faulty operation • Component failure 	<ul style="list-style-type: none"> • Reset the fault and restart • Should the fault re-occur, contact the distributor near you
7	Saturation Trip	Fault		<ul style="list-style-type: none"> • Short circuit in motor cables • IGBT module is damaged 	Check cables and connections Reset the fault and restart Verify that EMC screw is installed Should the fault re-occur, contact the distributor near you

Table 51. Fault Codes and Descriptions, continued

Fault Code	Fault Name	Fault Type	Default Fault Type	Possible Cause	Remedy
9	UnderVoltage	Configurable	Fault	DC link voltage is under the voltage limits defined: <ul style="list-style-type: none"> • Most probable cause: Too low a supply voltage • AC drive internal fault • Defect input fuse • External charge switch not closed Note: This fault is activated only if the drive is in Run state.	In case of temporary supply voltage break, reset the fault and restart the AC drive Check the supply voltage. If it is adequate, an internal failure has occurred. Contact the distributor near you
10	Input Phase Superv	Configurable	Fault	Input line phase is missing	Check supply voltage, fuses and cable
11	Output Phase Superv	Configurable	Fault	Current measurement has detected that there is no current in one motor phase	Check motor cable and motor
12	Brake Chopper Superv	Fault	Fault	<ul style="list-style-type: none"> • No brake resistor installed • Brake resistor is broken • Brake chopper failure 	Check brake resistor and cabling. If these are OK, the chopper is faulty. Contact the distributor near you
13	Drive UnderTemp	Configurable	Warning	Too low temperature measured in power unit's heat sink or board. Heat sink temperature is under -10°C	
14	Drive OverTemp	Fault	Fault	Too high temperature measured in power unit's heat sink or board. Heat sink temperature is over 90°C	<ul style="list-style-type: none"> • Check the correct amount and flow of cooling air • Check the heat sink for dust • Check the ambient temperature • Make sure that the switching frequency is not too high in relation to ambient temperature and motor load
15	Motor Stalled	Configurable	No Action	Motor is stalled	Check motor and load
16	Motor Over Temp	Configurable	No Action	Motor is too hot, based on either the drive's estimate or on temperature feedback	Decrease motor load. If no motor overload exists, check the temperature model parameters
17	Motor Under Load	Configurable	No Action	Condition defined by parameter P1.9.15–P1.9.17 have been valid longer than the time defined by P1.9.18	Check load
18	IP Address Conflict	Configurable	Warning	IP setting issue.	Check settings for IP address, verify no duplicates are on the network.
19	Power Board EEPROM Fault	Fault	Fault	Power board EEPROM fault, memory lost in EEPROM.	Cycle power to drive. Try updating software. If issue continues, contact distributor near you.
20	FRAM Fault	Fault	Fault	FRAM data error in FRAM memory.	Cycle power to drive. Try updating software. If issue continues, contact distributor near you.
21	S-Flash Fault	warning	Warning	Serial flash error, serial flash memory failed.	Cycle power to drive. Try updating software. If issue continues, contact distributor near you.
25	MCU WatchDog Fault	Fault	Fault	Watchdog register overflows in MCU	Cycle power to drive. Try updating software. If issue continues, contact distributor near you.
26	Start-up Prevent	Fault	Fault	The time when Interlock signal activates is over setting time.	Stop drive and resend start command.
29	Thermistor Fault	Configurable	Fault	Option board or control board thermistor resistor larger than 4.7K	Thermistor open or short, over temperature
32	Fan Cooling	Fault	Fault	Fan is damaged or stalled.	Check fan and fan connected wires, verify 24 Vdc is supplied to fan.

Appendix A—Fault and Warning Codes

Table 51. Fault Codes and Descriptions, continued

Fault Code	Fault Name	Fault Type	Default Fault Type	Possible Cause	Remedy
36	Compatibility Fault	Fault		The control board isn't matched with the power board.	Cycle power to drive. Try updating software. If issue continues, contact distributor near you.
37	Device Change	Warning		Power board or option card change.	Alarm will reset
38	Device Added	Warning		Power board or option board added.	Device is ready for use Old parameter settings will be used
39	Device Removed	Fault		Optional board removed from slot, or power board removed from control board.	Device no longer available in drive.
40	Device Unknown	Fault		Unknown device connected (power board/option board)	Check EEPROM connection. Check board connection on slot A/B Power cycle to drive.
41	IGBT Over Temp	Fault		IGBT temperature is too high.	<ul style="list-style-type: none"> • Check output loading • Check motor size • Decrease switching frequency
50	AI < 4mA (4to20mA)	Configurable	No Action	Loss in analog input signal, dropped below 4 mA.	Verify analog input current reference value on either AI1 or AI2, check cabling.
51	External Fault	Configurable	Fault	Digital input is activated for external fault input.	Check digital input settings and verify input level, could be an external device causing fault.
52	Keypad Comm Fault	Configurable	Fault	The connection between the control keypad and frequency converter is broken when the local reference is keypad or the local control place is keypad.	Check keypad connection and possible keypad cable.
54	Option Card Fault	Configurable	Fault	Defective option card or option card slot	Check right option card and option card slot connections. Check Board Status on Keypad for exact cause of fault. Contact distributor nearest you.
55	Realtime Clock Fault	Configurable	Warning	<ul style="list-style-type: none"> • Communication between MCU and RTC chip isn't normal • The power of RTC chip isn't normal • The real time isn't normal 	Check the RTC chip, power cycle to drive. If issue continues, contact distributor near you.
56	PT100 Fault	Configurable	Fault	Temperature is beyond the limit of sensing capacity of PT100	PT100 short, open or over temperature, check PT100 temperature probe.
57	Motor ID fault	Fault		The Motor parameters Identification running was not completed successfully	Check motor size Verify the input and output wiring is connected properly.
58	Current Measure Fault	Fault		Current measurement is out of range	Restart the drive again. Should the fault re-occur, contact the distributor near you
59	Power Wiring Error	Fault		Power wiring connected to output of drive.	Verify power input wiring is connected to L1, L2 and L3 terminals and that they are properly torqued.
60	Control Board OverTemp	Fault		Control board is over +85 degrees or under -30 degrees	Check NTC resistor Check control board temperature
61	Internal Control Supply	Fault		+24V port voltage is over 27V or under 17V	Check voltage range of +24V on terminals 12 to 13. If voltage is out of range, contact distributor near you.
62	Speed Search Fault	Fault		Speed searching failed when performing flying start.	Check motor parameters' setting and motor connections.
64	Replace Battery	Configurable	Warning	RTC battery voltage is too low.	Check the RTC battery voltage, contact distributor near you for replacement battery.

Table 51. Fault Codes and Descriptions, continued

Fault Code	Fault Name	Fault Type	Default Fault Type	Possible Cause	Remedy
65	Replace Fan	Configurable	Warning	Fan life is less than 2 months	Check the fan, clean out any contamination, contact distributor near you for replacement fan.
66	Safety Torque Off	Fault		STO Triggered, STO input is open.	Reset STO Trigger and verify wiring. Reset fault after input is enabled.
67	Current Limit Control	Warning		The output current has reached the current limit value	Check the load Set the acceleration time longer
68	Over Voltage Control	Warning		The DC link voltage has reached its voltage limit value	Check the input voltage Set the acceleration/deceleration time longer
69	System Fault	Fault		Thermistor SPI communication error.	Check thermistor chip.
70	System Fault	Fault		MCU send wrong parameters to DSP.	Restart the drive again. Should the fault re-occur, contact the distributor near you.
80	FieldBus Fault	Configurable	Fault	Loss of communication with BACnet/IP, and the fieldbus reference is the remote reference OR the fieldbus control place is the remote control place	Check RS-485 communication wiring. Verify drive parameters are set correctly. Check master programming to verify proper addressing.
81	FieldBus Fault	Configurable	Fault	Loss of communication with SA Bus, and the fieldbus reference is the remote reference OR the fieldbus control place is the remote control place	Check RS-485 communication wiring. Verify drive parameters are set correctly. Check master programming to verify proper addressing.
82	Bypass Overload	Fault		Over load when motor is in bypass mode	Check motor connection situation
83	FieldBus Fault	Configurable	Fault	Loss of communication with Modbus RTU, and the fieldbus reference is the remote reference OR the fieldbus control place is the remote control place	Check RS-485 communication wiring. Verify drive parameters are set correctly. Check master programming to verify proper addressing.
84	FieldBus Fault	Configurable	Fault	Loss of communication with Modbus TCP, and the fieldbus reference is the remote reference OR the fieldbus control place is the remote control place	Check Ethernet communication wiring. Verify drive parameters are set correctly. Check master programming to verify proper addressing.
85	FieldBus Fault	Configurable	Fault	Loss of communication with BACnet, and the fieldbus reference is the remote reference OR the fieldbus control place is the remote control place, and the fault protection is not "NO action"	Check RS-485 communication wiring. Verify drive parameters are set correctly. Check BACnet master configuration programming to verify proper addressing.
86	FieldBus Fault	Configurable	Fault	Loss of communication with EtherNet/IP, and the fieldbus reference is the remote reference OR the fieldbus control place is the remote control place, and the fault protection is not "NO action"	Check Ethernet communication wiring. Verify drive parameters are set correctly. Check EIP master configuration programming to verify proper addressing.
87	FieldBus Fault	Configurable	Fault	Loss of communication with Profibus/CANopen/DeviceNet master on Slot A, and the fieldbus reference is the remote reference OR the fieldbus control place is the remote control place, and the fault protection is not "NO action"	Check Profibus/CANopen/DeviceNet communication wiring. Verify drive parameter are set correctly. Check Profibus/CANopen/DeviceNet master configuration programming to verify proper addressing.
88	FieldBus Fault	Configurable	Fault	Loss of communication with Profibus/CANopen/DeviceNet master on Slot B, and the fieldbus reference is the remote reference OR the fieldbus control place is the remote control place, and the fault protection is not "NO action"	Check Profibus/CANopen/DeviceNet communication wiring. Verify drive parameter are set correctly. Check Profibus/CANopen/DeviceNet master configuration programming to verify proper addressing.
89	Under Voltage Stop	Fault		The DC link voltage has reached the Drive under voltage stop limit value.	Check the input voltage.

Table 51. Fault Codes and Descriptions, continued

Fault Code	Fault Name	Fault Type	Default Fault Type	Possible Cause	Remedy
90	Drive Under Temp	Warning/Fault		<ul style="list-style-type: none"> • Cold weather mode is not enabled, and unit temperature is less than -10 degree. • Cold weather mode is enabled and Under Temp Fault Override is not set, unit temperature is less than -30 degree. • Cold weather mode is enabled and Under Temp Fault Override is not set, unit temperature is -20~ -30 degree. The temp <-20 degree when cold weather start times out. 	<p>If unit temp -20 ~ -10 degree, start motor in cold weather mode.</p> <p>If unit temp <-20°, warm up unit above -20°C for proper operation using cold weather mode.If still < -20° when cold weather mode times out, try higher output voltage in cold weather mode.</p>
91	Option Card Fault	Configurable	Fault	External supply on the DeviceNet communication connector is not present.	Check voltage and wiring of power supply of the DeviceNet communication.
92	External Fault 2	Configurable	Fault	Digital input is activated for external fault input.	Check digital input settings and verify input level, could be an external device causing fault.
93	External Fault 3	Configurable	Fault	Digital input is activated for external fault input.	Check digital input settings and verify input level, could be an external device causing fault.
103	Drive OverTemp Warning	Warning		Drive degree greater than (DCI_wDriveOverTempThreshold value -10 degree) and less than DCI_wDriveOverTempThreshold value,report drive over temperature warning.	Check the drive degree
104	Compatibility Fault	Warning		DSP firmware is not compatible with MCB firmware	Check the DSP firmware revision
105	Compatibility Fault	Warning		Keypad firmware is not compatible with MCB firmware	Check the keypad firmware revision
106	Compatibility Fault	Warning		IO1 card firmware is not compatible with MCB firmware	Check the IO1 card firmware revision
107	Compatibility Fault	Warning		IO2 card firmware is not compatible with MCB firmware	Check the IO2 card firmware revision
108	Compatibility Fault	Warning		IO3 card firmware is not compatible with MCB firmware	Check the IO3 card firmware revision
109	Compatibility Fault	Warning		IO4 card firmware is not compatible with MCB firmware	Check the IO4 card firmware revision
110	Compatibility Fault	Warning		IO5 card firmware is not compatible with MCB firmware	Check the IO5 card firmware revision
111	Compatibility Fault	Warning		Profibus card firmware is not compatible with MCB firmware	Check the Profibus card firmware revision