

Application manual



Disclaimer of warranties and limitation of liability

The information, recommendations, descriptions, and safety notations in this document are based on Eaton's experience and judgment and may not cover all contingencies. If further information is required, an Eaton sales office should be consulted. Sale of the product shown in this literature is subject to the terms and conditions outlined in appropriate Eaton selling policies or other contractual agreement between Eaton and the purchaser.

THERE ARE NO UNDERSTANDINGS, AGREEMENTS, WARRANTIES, EXPRESSED OR IMPLIED, INCLUDING WARRANTIES OF FITNESS FOR A PARTICULAR PURPOSE OR MERCHANTABILITY, OTHER THAN THOSE SPECIFICALLY SET OUT IN ANY EXISTING CONTRACT BETWEEN THE PARTIES. ANY SUCH CONTRACT STATES THE ENTIRE OBLIGATION OF EATON. THE CONTENTS OF THIS DOCUMENT SHALL NOT BECOME PART OF OR MODIFY ANY CONTRACT BETWEEN THE PARTIES.

In no event will Eaton be responsible to the purchaser or user in contract, in tort (including negligence), strict liability, or otherwise for any special, indirect, incidental, or consequential damage or loss whatsoever, including but not limited to damage or loss of use of equipment, plant or power system, cost of capital, loss of power, additional expenses in the use of existing power facilities, or claims against the purchaser or user by its customers resulting from the use of the information, recommendations, and descriptions contained herein. The information contained in this manual is subject to change without notice.

Cover Photo: Eaton PowerXL® Series Drives

Support services

Support services

The goal of Eaton is to ensure your greatest possible satisfaction with the operation of our products. We are dedicated to providing fast, friendly, and accurate assistance. That is why we offer you so many ways to get the support you need. Whether it is by phone, fax, or email, you can access Eaton's support information 24 hours a day, seven days a week.

Our wide range of services is listed below.

You should contact your local distributor for product pricing, availability, ordering, expediting, and repairs.

Website

Use the Eaton Website to find product information. You can also find information on local distributors or Eaton's sales offices.

Website address

www.eaton.com/drives

EatonCare customer support center

Call the EatonCare Support Center if you need assistance with placing an order, stock availability or proof of shipment, expediting an existing order, emergency shipments, product price information, returns other than warranty returns, and information on local distributors or sales offices.

Technical support contact information

	Americas	EMEA	APAC
Website	www.eaton.com/drives	www.eaton.eu/electrical	www.eaton.com.cn/electrical
Email	VFDaftermarketEG@eaton.com	AfterSalesEGBonn@eaton.com	CustomerServicePDCNA@eaton.com
Phone	1-877-386-2273 (8:00 a.m. to 6:00 p.m. Eastern Time U. S. [UTC-5]) 800-543-7038 (6:00 p.m. to 8:00 a.m. Eastern Time U.S. [UTC-5]) TRCDrivesTechSupport@eaton.com	+49 (0) 180 5 223822	800 9881203

Table of contents

DISCLAIMER OF WARRANTIES AND LIMITATION OF LIABILITY	II
SUPPORT SERVICES	III
Support services	iii
Website	iii
Website address	iii
EatonCare customer support center	iii
Technical support contact information	iii
SAFETY	VIII
Definitions and symbols	viii
Hazardous high voltage	viii
Warnings and cautions	viii
CHAPTER 1 - POWERXL DM1 SERIES OVERVIEW	1
How to use this manual	1
Rating label	1
Carton labels (U.S. and Europe)	2
CHAPTER 2 - KEYPAD OVERVIEW	3
Main keypad buttons	4
Main keypad display	5
Menu navigation - main keypad	6
Remote keypad overview	7
Remote keypad buttons	8
LED lights	10
LCD display	10
Menu navigation - remote keypad	11
CHAPTER 3 - STARTUP	12
Start-up wizard	12
CHAPTER 4 - STANDARD	16
CHAPTER 5 - FAN CONTROL APPLICATION	45
Introduction	45
I/O controls	45
Control I/O configuration	46
Fan application - parameters list	47

Table of contents, continued

CHAPTER 6 - PUMP CONTROL APPLICATION	85
Introduction	85
I/O controls	85
Control I/O configuration	86
Pump application - parameters list	87
CHAPTER 7- MULTI-PURPOSE APPLICATION	134
Introduction	134
Control I/O configuration	135
Multi-purpose application - parameters list	139
APPLICATION NOTES	230
Faults and warning codes	230
Fault codes and descriptions	230
Recommended secure hardening guidelines	234
References	236

List of figures

Figure 1. Rating label	1
Figure 2. Carton rating label	2
Figure 3. Main keypad and display	3
Figure 4. Main keypad display and labels	5
Figure 5. Main keypad menu navigation	6
Figure 6. Remote keypad and display	7
Figure 7. General view of LCD	10
Figure 8. Remote keypad menu navigation	11
Figure 9. Example application with three auxiliary drives	136
Figure 10. Multi-pump control curve	137
Figure 11. Multi-drive/multi-pump layout	137
Figure 12. Bandwidth feedback	138

List of tables

Table 1. Common abbreviations.....	1
Table 2. Keypad buttons.....	4
Table 3. Remote keypad buttons.....	8
Table 4. LED state indicators.....	10
Table 5. Start-up wizard instructions.....	12
Table 7. Operate mode - O.....	18
Table 8. Parameters	18
Table 9. Inputs	20
Table 10. Outputs	25
Table 11. Drive control	26
Table 12. Motor control	27
Table 13. Protections	29
Table 14. PI Controller	31
Table 15. Setpoint	33
Table 16. Feedback	34
Table 17. Serial communication.....	34
Table 18. Ethernet communication.....	38
Table 19. System.....	42
Table 20. Fan application default I/O connection.....	46
Table 21. Monitor.....	47
Table 22. Parameters	49
Table 23. Inputs.....	51
Table 24. Outputs	59
Table 25. Drive control	61
Table 26. Motor control.....	64
Table 27. Protections.....	65
Table 28. PI Controller.....	67
Table 29. Setpoint.....	69
Table 30. Feedback	71
Table 31. HVAC parameters	72
Table 32. Serial communication.....	75
Table 33. Ethernet communication.....	77
Table 34. System (Cont.).....	81
Table 35. Multi-Pump application default I/O connection.....	86
Table 36. Monitor	87
Table 37. Multi-pump status.....	89
Table 38. Multi-pump measurement.....	91
Table 39. Parameters	95
Table 40. Inputs.....	97
Table 41. Outputs.....	106
Table 42. Drive control	108
Table 43. Motor control	111
Table 44. Protections	112
Table 45. PI Controller	114
Table 46. Setpoint.....	116
Table 47. Feedback	118
Table 48. Pump parameters	119

List of table, continued

Table 49. Serial communication	124
Table 50. Ethernet communication	127
Table 51. System	131
Table 52. Multi-purpose application default I/O connection..	135
Table 53. Monitor	139
Table 54. Multi-pump status.	142
Table 55. Multi-pump measurement	145
Table 56. Parameters.	148
Table 57. Inputs	150
Table 58. Outputs.	165
Table 59. Drive control.	174
Table 60. Motor control.	180
Table 61. Protections.	184
Table 62. PI Controller	193
Table 63. Setpoint	195
Table 64. Feedback	198
Table 65. HVAC parameters.	198
Table 66. Pump parameters	201
Table 67. Fieldbus (FB) status	206
Table 68. Serial communication	217
Table 69. Ethernet communication	220
Table 70. System	224
Table 71. Active faults.	230
Table 72. History faults.	230

Safety

WARNING! **DANGEROUS ELECTRICAL VOLTAGE!**

Read this manual thoroughly and make sure you understand the procedures before you attempt to install, set up, operate or carry out any maintenance work on this PowerXL Adjustable Frequency Drive.

Definitions and symbols

WARNING

This symbol indicates high voltage. It calls your attention to items or operations that could be dangerous to you and other persons operating this equipment. Read the message and follow the instructions carefully.



This symbol is the "Safety Alert Symbol." It occurs with either of two signal words: CAUTION or WARNING, as described below.

WARNING

Indicates a potentially hazardous situation which, if not avoided, can result in serious injury or death.

CAUTION

Indicates a potentially hazardous situation which, if not avoided, can result in minor to moderate injury, or serious damage to the product. The situation described in the CAUTION may, if not avoided, lead to serious results. Important safety measures are described in CAUTION (as well as WARNING).

Hazardous high voltage

WARNING

Motor control equipment and electronic controllers are connected to hazardous line voltages. When servicing drives and electronic controllers, there may be exposed components with housings or protrusions at or above line potential. Extreme care should be taken to protect against shock.

- Stand on an insulating pad and make it a habit to use only one hand when checking components.
- Always work with another person in case an emergency occurs.
- Disconnect power before checking controllers or performing maintenance.
- Be sure equipment is properly earthed.
- Wear safety glasses whenever working on electronic controllers or rotating machinery.

WARNING

The components in the drive's power section remain energized after the supply voltage has been switched off. After disconnecting the supply, wait at least five minutes before removing the cover to allow the intermediate circuit capacitors to discharge.

Pay attention to hazard warnings!



DANGER
5 MIN

WARNING

Electric shock hazard—risk of injuries! Carry out wiring work only if the unit is de-energized.

WARNING

Do not perform any modifications on the AC drive when it is connected to mains.

Warnings and cautions

WARNING

Be sure to ground the unit following the instructions in this manual. Ungrounded units may cause electric shock and/or fire.

WARNING

This equipment should only be installed, adjusted, and serviced by qualified electrical maintenance personnel familiar with the construction and operation of this type of equipment and the hazards involved. Failure to observe this precaution could result in death or severe injury.

WARNING

Components within the drive are live when it is connected to power. Contact with this voltage is extremely dangerous and may cause death or severe injury.

WARNING

Line terminals (L1, L2, L3), motor terminals (U, V, W) and the brake resistor terminals (R+, R-) are live when the drive is connected to power, even if the motor is not running. Contact with this voltage is extremely dangerous and may cause death or severe injury.

EMC warnings and cautions

WARNING

In a residential environment, this product may cause radio interference, in which case supplementary mitigation measures may be required.

WARNING

- This type of PDS is not intended to be used on a low-voltage public network which supplies residential premises.
- Radio frequency interference is expected if used on such a network.

CAUTION

This device complies with part 15 of the FCC Rules. Operation is subject to the following two conditions: (1) This device may not cause harmful interference, and (2) this device must accept any interference received, including interference that may cause undesired operation.

WARNING

Even though the control I/O-terminals are isolated from line voltage, the relay outputs and other I/O-terminals may have dangerous voltage present even when the drive is disconnected from power. Contact with this voltage is extremely dangerous and may cause death or severe injury.

WARNING

This equipment has a large capacitive leakage current during operation, which can cause enclosure parts to be above ground potential. Proper grounding, as described in this manual, is required. Failure to observe this precaution could result in death or severe injury.

WARNING

Before applying power to this drive, make sure that the front and cable covers are closed and fastened to prevent exposure to potential electrical fault conditions. Failure to observe this precaution could result in death or severe injury.

WARNING

An upstream disconnect/protective device must be provided as required by the National Electric Code® (NEC®). Failure to follow this precaution may result in death or severe injury.

WARNING

This drive can cause a DC current in the protective earthing conductor. Where a residual current-operated protective (RCD) or monitoring (RCM) device is used for protection in case of direct or indirect contact, only an RCD or RCM of Type B is allowed on the supply side of this product.

WARNING

Carry out wiring work only after the drive has been correctly mounted and secured.

WARNING

Before opening the drive covers:

- Disconnect all power to the drive, including external control power that may be present
- Wait a minimum of five minutes after all the lights on the keypad are off. This allows time for the DC bus capacitors to discharge
- A hazard voltage may still remain in the DC bus capacitors even if the power has been turned off. Confirm that the capacitors have fully discharged by measuring their voltage using a multimeter set to measure the DC voltage

Failure to follow these precautions may cause death or severe injury.

WARNING

The opening of the branch-circuit protective device may be an indication that a fault current has been interrupted. To reduce the risk of fire or electric shock, current-carrying parts and other components of the controller should be examined and replaced if damaged. If burnout of the current element of an overload relay occurs, the complete overload relay must be replaced.

WARNING

Operation of this equipment requires detailed installation and operation instructions provided in the Installation/Operation manual intended for use with this product. It should be retained with this device at all times. A hard copy of this information may be ordered from literature fulfillment.

⚠ WARNING

Before servicing the drive:

- Disconnect all power to the drive, including external control power that may be present.
- Place a “DO NOT TURN ON” label on the disconnect device. Lock the disconnect device in the open position.

Failure to follow these precautions may cause death or severe injury.

⚠ WARNING

The drive outputs (U, V, W) must not be connected to the input voltage or the utility line power as severe damage to the device may occur and there may be a risk of fire.

⚠ WARNING

The heat sink and/or outer enclosure may reach a high temperature.

Pay attention to hazard warnings!



Hot Surface—Risk of Burn. DO NOT TOUCH!

⚠ WARNING

In a domestic environment, this product may cause radio interference, in which case supplementary mitigation measures may be required.

Chapter 1 - PowerXL DM1 series overview

This chapter describes the purpose and contents of this manual, the receiving inspection recommendations and the PowerXL Series Open Drive catalog numbering system.

How to use this manual

The purpose of this manual is to provide you with information necessary to install, set and customize parameters, start up, troubleshoot, and maintain the Eaton PowerXL Series variable frequency drive (VFD). To provide for safe installation and operation of the equipment, read the safety guidelines at the beginning of this manual and follow the procedures outlined in the following chapters before connecting power to the PowerXL Series VFD. Keep this operating manual handy and distribute to all users, technicians and maintenance personnel for reference.

Table 1. Common abbreviations.

Abbreviation	Definition
CT	Constant torque with high overload rating (150%)
VT	Variable torque with low overload rating (110%)
IH	High overload current (150%)
I _L	Low overload current (110%)
VFD	Variable frequency drive
RTC	Real time clock









Rating label

Figure 1. Rating label.



Carton labels (U.S. and Europe)

Figure 2. Carton rating label.

 Powering Business Worldwide			
Cat. No.: DM1-321D6EB-S20S			
Style No.: 3-5001-001A			
PowerXL™ DM1 VFD Factory ID: T			
CT/VT		Input	Output
0.25HP/ 0.5HP (0.18KW/ 0.37KW)	U(V~)	208-240 3Ø	0~Vin 3Ø
	F(Hz)	50/60 Hz	0-400 Hz
	I (A)	3.3	1.6/2.5
Enclosure Rating	IP20 / UL Open Type IP20 / NEMA 1 / UL Type 1 with NEMA 1 kit installed		
User installation manual:TBD			
Serial No.: XXXXXXXXXX			
 EAN: XXXXXXXXXX			
 NAED: XXXXXXXXXX			
			
			
Contains FCC ID: 2ADXE-HY-40R204PC			
N.W.: XX.XX KG		G.W.: XX.XX KG	
190524 Assembled in Dominican Republic			

Chapter 2 - Keypad overview

The keypad is the interface between the drive and the user. It features an LCD display, speed potentiometer, and navigation buttons. With the control keypad, it is possible to control the speed of a motor, to supervise the state of the equipment, and to set the frequency converter's parameters (see **Figure 3**).

Figure 3. Main keypad and display.

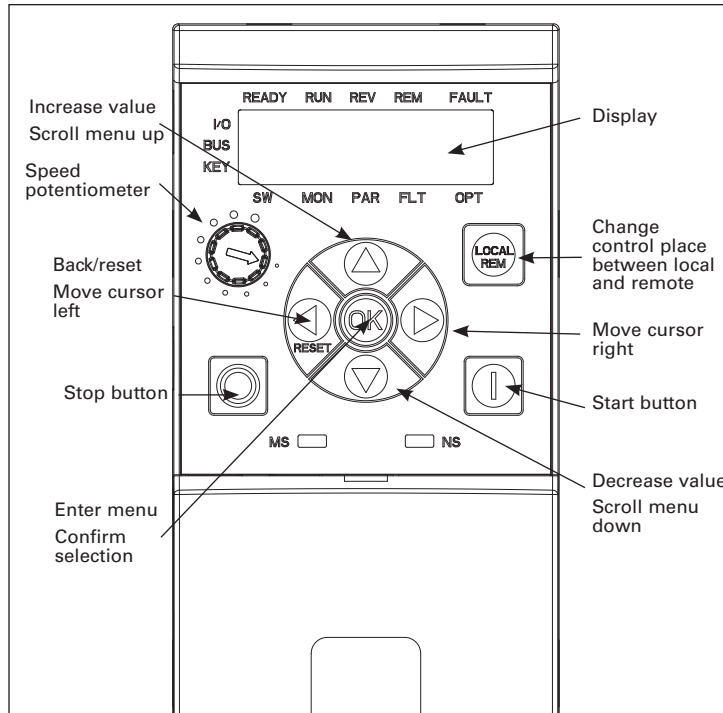

Main keypad buttons

Buttons description

Table 2. Keypad buttons.







Icon	Button	Description
	Local/Remote	Local/Remote: Switches between LOCAL and REMOTE control for start and speed reference. The control locations corresponding to local and remote shall be selected within an application.
	Start	Start: This button operates as motor start button for normal operation when the “Keypad” is selected as the active control source. When Keypad is the reference place after hitting the start button, it will jump directly to the Keypad Ref Screen.
	Stop	Stop: This button operates as motor stop button for normal operation when the “Keypad” is selected as the control source and keypad stop button is active, or stop button is always enabled regardless of control source. <ul style="list-style-type: none"> Motor stop from the keypad.
	Up	Up and Down arrows: <ul style="list-style-type: none"> Move either up or down a menu list to select the desired menu item. Editing a parameter bit by bit, while the active digit is scrolled. Increase/decrease the reference value of the selected parameter. In parameter page when in read mode, move to the previous or next brother parameter of this parameter.
	Down	
	Left/Back/Reset	Left arrow: <ul style="list-style-type: none"> Navigation button, movement to left when editing a parameter digit by digit. Backs up one step. At Main Menu page by hitting Back/Reset takes to Default Page. Back/Reset: This button has three integrated functions. The button operates as backward button during normal mode. In edit mode, it is used as cancel operate. It is also used to reset faults when faults occur. <ul style="list-style-type: none"> Backs up one step Cancel Modify in edit mode Resets the active faults (all the active faults shall be reset by pressing this button more than 2s in any page) Hold Stop and Back Reset for 5 seconds to return drive to factory default At Main Menu page by hitting Back/Reset takes to Default Page.

Table 2. Keypad buttons (Cont.).

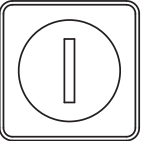
Icon	Button	Description
	Right	<p>Right arrow:</p> <ul style="list-style-type: none"> • Enter parameter group mode. • Enter parameter mode from group mode. • Enter parameter whole edit mode when this parameter can be written. • Enter parameter bit by bit edit mode from whole edit mode. • Navigation button, movement to right when editing a parameter bit by bit.
	OK	<p>OK:</p> <ul style="list-style-type: none"> • To clear all the Fault History if pressed for more than 5 s (including 5 s) in any page. • This button is used in the parameter edit mode to save the parameter setting. • To confirm the start-up list at the end of the Start-Up Wizard. • To confirm the comparison item in parameters comparison mode. <p>The following is the same with Right key:</p> <ul style="list-style-type: none"> • Enter parameter whole edit mode when this parameter can be written. • Enter parameter group mode. • Enter parameter mode from group mode.

Main keypad display

The main keypad LCD display indicates the status of the motor and the drive and any faults in motor or drive functions. On the display, the user sees information about the current location in the menu structure and the item displayed.

Figure 4. Main keypad display and labels.

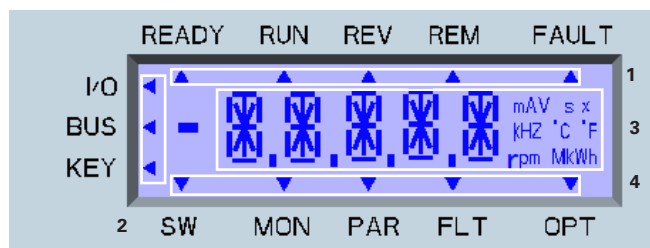

Overview

The display on the main keypad is a customized LCD with four information areas:

1. **(Top line)** The top line is state line and indicates whether the device state is:
 - Ready/NRD; Remote/Local;
 - RUN/STP;
 - REV/FWD;
 - Remote/Local; or
 - Fault (lit)/Warning (flashing).

2. **(Left line)** The left line indicates the control source:
 - IO;
 - BUS; or
 - KEY.
3. **(Middle line)** The middle line is the parameter:
 - Path;
 - Value; or
 - Unit.
4. **(Bottom line)** The bottom line is the menu line. It indicates which parameter menu is selected. The choices are:
 - SW: Start-up wizard;
 - MON: Monitor;
 - PAR: Parameter;
 - FLT: Fault; or
 - OPT: Option cards.

Menu navigation - main keypad

This section provides basic instruction on navigating each section in the menu structure from the main keypad.

Figure 5. Main keypad menu navigation.

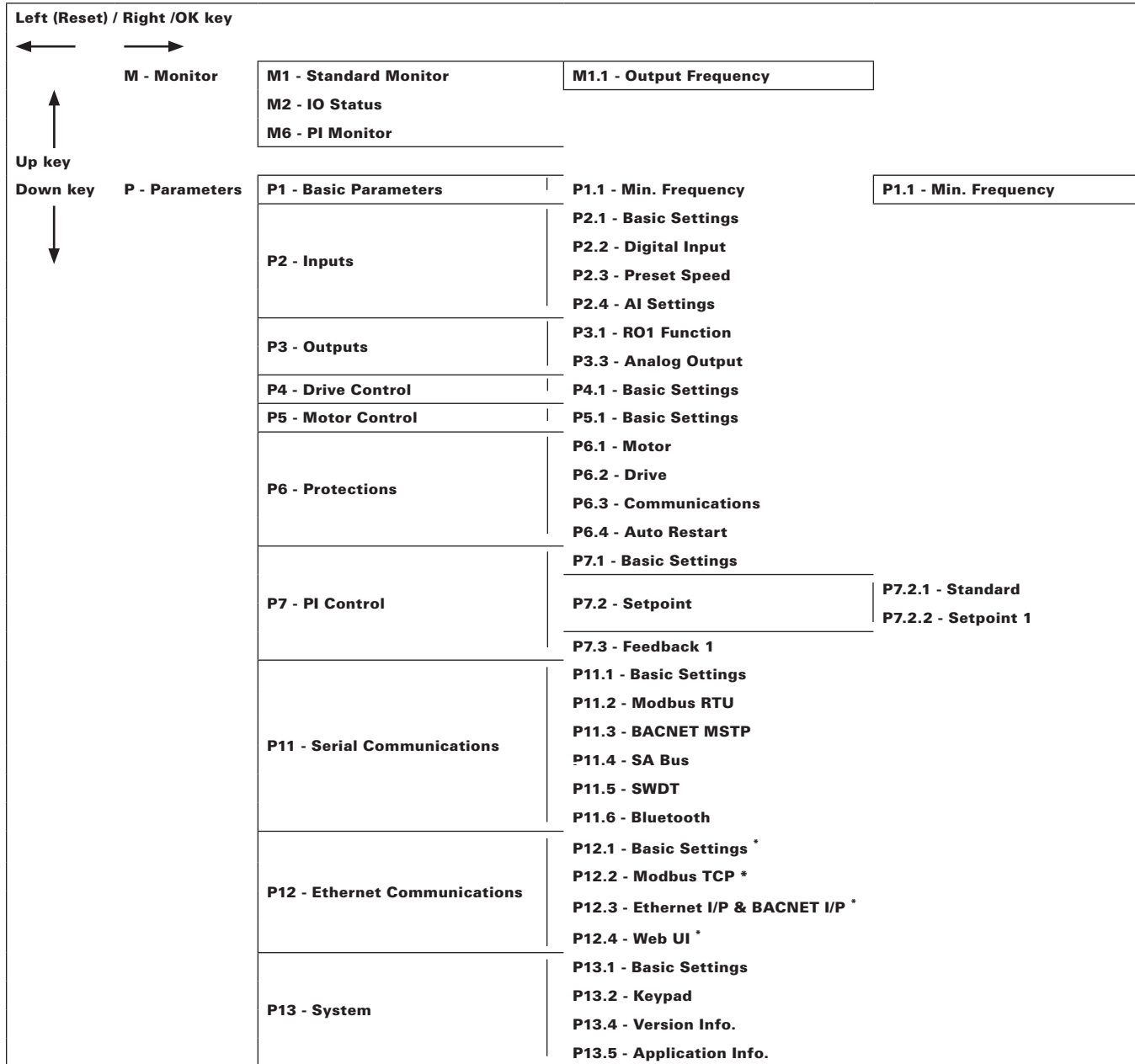

* = DM1 PRO Only.

Remote keypad overview

The remote keypad is another interface between the drive and the user. It features an LCD display, 3 LED lights and 11 buttons. With the control keypad, it is possible to control the speed of a motor, to supervise the state of the equipment, and to set the frequency converter's parameters.

Figure 6. Remote keypad and display.

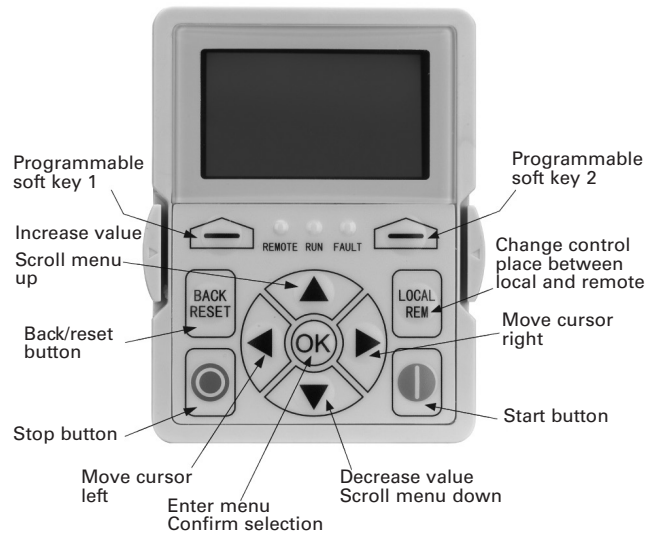

Remote keypad buttons

Buttons description

Table 3. Remote keypad buttons.









Icon	Button	Description
	Soft key 1, Soft key 2	Soft key 1, soft key 2: Soft keys 1 and 2 have no functionality with the DM1 device.
	Back/Reset	Back/Reset: This button has three integrated functions. The button operates as backward button during normal mode. In edit mode, it is used as cancel operate. It is also used to reset faults when faults occur. <ul style="list-style-type: none"> • Backs up one step. • Cancels Modify in edit mode. • Resets the active faults (all the active faults shall be reset by pressing this button more than 2 seconds in any page). • Hold Stop and Back Reset for 5 seconds to return drive to factory default. • At Main Menu page, pressing Back/Reset takes the user to the Default page.
	Local/Remote	Local/Remote: Switches between Local and Remote control for start and speed reference. The control locations corresponding to Local and Remote shall be selected within an application.
	Up Down	Up and down arrows: <ul style="list-style-type: none"> • Move either up or down a menu list to select the desired menu item. • Editing a parameter bit by bit, while the active digit is scrolled. • Increase/decrease the reference value of the selected parameter. • In Parameter Comparison mode, scroll through the parameters of which current value is different from the comparison parameter value. • In the Parameter page when in read mode, move to the previous or next brother parameter of this parameter.

Table 3. Remote keypad buttons (Cont.).

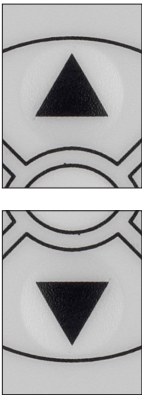
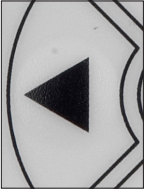
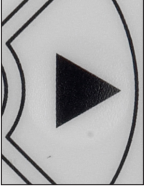
	Left	<p>Left arrow:</p> <ul style="list-style-type: none"> • Navigation button, movement to left when editing a parameter digit by digit. • Backs up one step. • At Main Menu page by hitting Back/Reset takes the user to the Default page.
	Right	<p>Right arrow:</p> <ul style="list-style-type: none"> • Enter parameter group mode. • Enter parameter mode from group mode. • Enter parameter whole edit mode when this parameter can be written. • Enter parameter bit by bit edit mode from whole edit mode. • Navigation button, movement to right when editing a parameter bit by bit.
	OK	<p>OK:</p> <ul style="list-style-type: none"> • To clear all the Fault History if pressed for more than 5 seconds (including 5 seconds) in any page. • This button is used in the parameter edit mode to save the parameter setting. • To confirm the start-up list at the end of the Start-Up Wizard. • To confirm the comparison item in parameters comparison mode. <p>The following is the same with Right key:</p> <ul style="list-style-type: none"> • Enter parameter whole edit mode when this parameter can be written. • Enter parameter group mode. • Enter parameter mode from group mode..
	Stop	<p>Stop:</p> <p>This button operates as motor stop button for normal operation when the “Keypad” is selected as the control source and keypad stop button is active, or stop button is always enabled regardless of control source.</p> <ul style="list-style-type: none"> • Motor stop from the keypad.
	Start	<p>Start:</p> <p>This button operates as motor start button for normal operation when the “Keypad” is selected as the active control source. When Keypad is the reference place after hitting the start button, it will jump directly to the Keypad Ref Screen.</p>

LED lights

Table 4. LED state indicators.

Indicator	Description
 Run	Green Run: Indicates that the VFD is running and controlling the load in Drive or Bypass. Blinks when a stop command has been given but the drive is still ramping down.
 Fault	Red Fault: Turns on when there is one or more active drive fault(s).
 Remote	Yellow Local/Remote: Local: If the local control place is selected, turns off the light. Remote: If the remote control place is selected, turns on the light.

LCD display

The keypad LCD indicates the status of the motor and the drive and any faults in motor or drive functions. On the LCD, the user sees information about the current location in the menu structure and the item displayed.

Overview

Five lines shall be displayed in the screen. General view is as following in Figure 3.

Figure 7. General view of LCD.

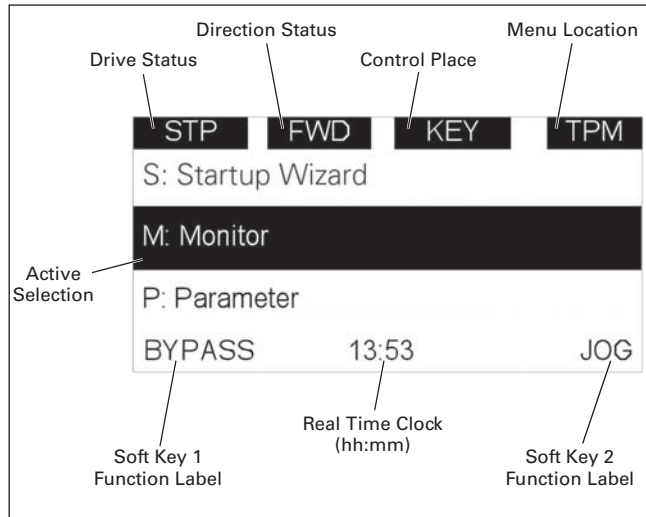

The lines definition is as below.

The first line is State line, shows:

- **RUN/STP/NRD/FIM/TFM** - If motor is running, the run state shall display "RUN"; otherwise the state display "STP". "RUN" blinks when the stop command is sent but the drive is decelerating. "NRD" is displayed if the drive is not ready or does not have a signal "FIM" is displayed to indicate it is in Fire Mode and the drive is in a Run state. "TFM" is displayed when in the Fire Mode Test Mode and the drive is in a Run State.
- **FWD/REV/JOG** - If the motor running direction is clockwise, display "FWD"; otherwise display "REV". "Jog" if the drive is in Jog mode the status indication will occur.
- **KEY/I/O/BPS/RBP/BUS/OFF** - If it is in bypass currently, display "BPS"; when run command is given it will got to "RBP"; otherwise, if the current control source is I/O terminal, display "I/O". If it is keypad, then display "KEY"; otherwise display "BUS." If HOA enabled and switch to OFF, it shall show OFF.
- **PAR/MON/FLT/OPE/QSW/FAV/TPM/MS1/SL1/SL2/SL3/SL4/BUx** - If the current page is parameter menu, display "PAR". If monitor menu, then display "MON". If fault menu, then display "FLT". If operation menu, then display "OPE". If quick start wizard, then display "QSW". If optional card menu, then display "BOA". If favorite menu, then display "FAV". If main menu, then display "TPM". When doing the Multi-drive Pump and Fan mode, the drive mode will be defined with MS- Master and SL being a slave drive. The 1 through 5 will indicate the number in the series it is. "BUx" indicates the drive being a backup drive when in the redundant drive system.

The second line is Code line, shows the menu code.

The third line is Name line, shows the menu name or parameters name.

The fourth line is Value line, shows the submenu name or parameters value.

The fifth line is Soft Key line, the functions of Soft Key 1 and Soft Key 2 are changeable, and the real time is in the middle.

Menu navigation - remote keypad

This section provides basic instruction on navigating each section in the menu structure from the remote keypad.

Figure 8. Remote keypad menu navigation.

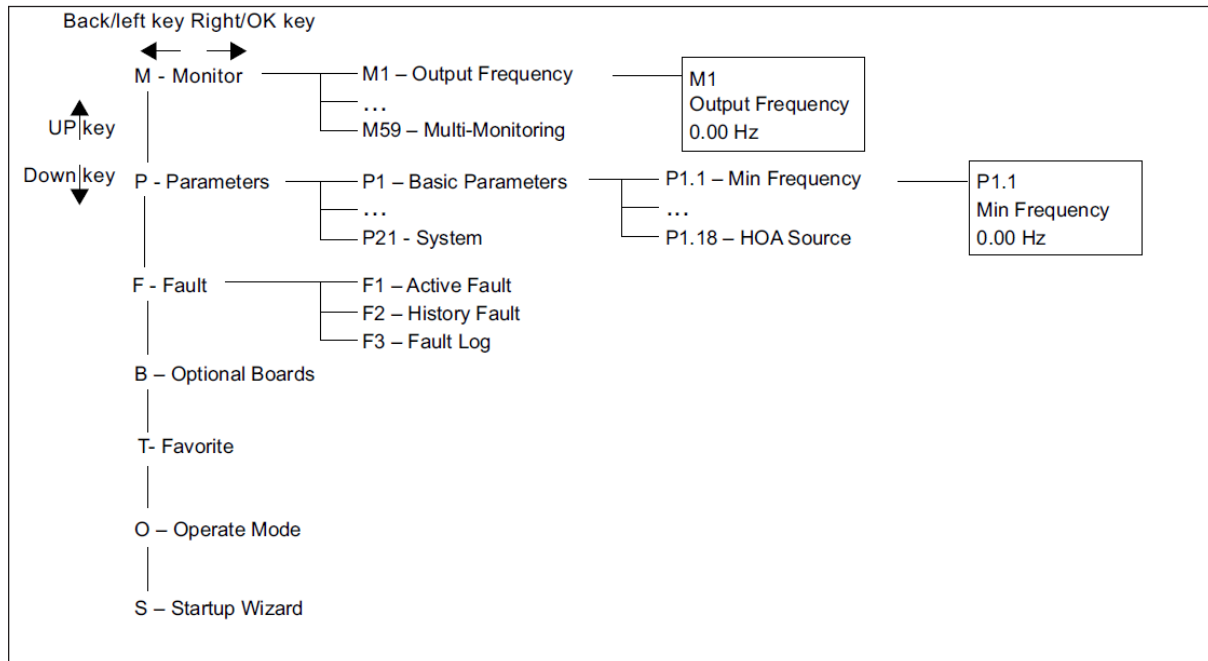

Chapter 3 - Startup

Start-up wizard

In the *Start-up Wizard*, you will be prompted for essential information needed by the drive so that it can start controlling your process. In the Wizard, you will need the following keypad buttons:

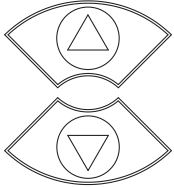

Up/down buttons.

Use these to changes value(s).



OK button.

Confirm selection with this button, and enter into next question.



Left/back/reset button.

If this button was pressed at the first question, the Start-up Wizard will be cancelled.

If this button is pressed in any step on the Start-up Wizard, the Start-up Wizard will be cancelled.

Once you have connected power to your Eaton PowerXL frequency converter, and the Start-up Wizard is enabled, follow these instructions to easily set up your drive.

Table 5. Start-up wizard instructions .

P13.1.7	Parameter lock PIN			ID 624
Minimum value:	0	Maximum value:	9999	Default value: 0
Description:	<p>The application selection can be protected against unauthorized changes with the password function. When the password function is enabled, the user will be prompted to enter a password before application changes, parameter value changes, or password changes.</p> <p>By default, the password function is not in use. If you want to activate the password, change the value of this parameter to any number between 1 and 9999.</p> <p>To deactivate the password, reset the parameter value to 0.</p>			
P1.1²	Minimum frequency			ID 101
Minimum value:	0.00 Hz	Maximum value:	400.00 Hz	Default value: 0.00 Hz
Description:	<p>These define the frequency limits of the frequency converter. The maximum value for these parameters is 400 Hz. The minimum frequency has to be below the maximum frequency level. These will limit other frequency parameter settings; preset speeds, jog speed, 4 mA fault preset speed, fire mode speed, and brake speed settings.</p>			
P1.2²	Maximum frequency			ID 102
Minimum value:	0.00 Hz	Maximum value:	400.00 Hz	Default value: MaxFreqMFG
Description:	<p>These define the frequency limits of the frequency converter. The maximum value for these parameters is 400 Hz. The minimum frequency has to be below the maximum frequency level. These will limit other frequency parameter settings; preset speeds, jog speed, 4 mA fault preset speed, fire mode speed, and brake speed settings.</p>			

Table 5. Start-up wizard instructions (Cont.).

P1.6^①	Motor nominal current	ID 486
Minimum value:	DriveNomCurrCT*1/10 A	Maximum value: DriveNomCurrCT*2 A
Default value:	DriveNomCurrCT	
Description:	Motor nominal nameplate full load current. Find this value on the rating plate of the motor.	

The diagram shows a motor with a callout box containing a simulated nameplate. The nameplate has the following fields:

- Top left: 230/400V (labeled as Motor Nom. Voltage)
- Top right: 4.0/2.3A (labeled as Motor Nom. Current)
- Middle left: 0.75 kW
- Middle right: cos φ 0.67 (labeled as Motor PF)
- Bottom left: 1410 min⁻¹ (labeled as Motor Nom. Speed)
- Bottom right: 50 Hz (labeled as Motor Nom. Frequency)

P1.7^①	Motor nominal speed	ID 489
Minimum value:	300 rpm	Maximum value: 20,000 rpm
Default value:	MotorNomSpeedMFG	
Description:	Motor nominal nameplate base speed. Find this value on the rating plate of the motor.	
P1.8^①	Motor power factor	ID 490
Minimum value:	0.30	Maximum value: 1.00
Default value:	0.85	
Description:	Motor nominal nameplate full load power factor. Find this value on the rating plate of the motor.	
P1.9^①	Motor nominal voltage	ID 487
Minimum value:	180 V	Maximum value: 690 V
Default value:	MotorNomVoltMFG	
Description:	Motor nominal nameplate base voltage. Find this value on the rating plate of the motor.	
P1.10^①	Motor nominal frequency	ID 488
Minimum value:	8.00 Hz	Maximum value: 400.00 Hz
Default value:	MotorNomFreqMFG	
Description:	Motor nominal nameplate frequency. Find this value on the rating plate of the motor. This parameter sets the field weakening point (P8.4) to the same.	
P1.3^②	Acceleration time 1	ID 103
Minimum value:	0.1 s	Maximum value: 3000.0 s
Default value:	20.0 s	
Description:	The time required for the output frequency to accelerate from zero frequency to maximum frequency (P1.2). When accelerating from different frequency levels, the acceleration time will be a fraction of the total ramp time.	

Table 5. Start-up wizard instructions (Cont.).

P1.4^②	Deceleration time 1			ID 104
Minimum value:	0.1 s	Maximum value:	3000.0 s	Default value: 20.0 s
Description:	The time required for the output frequency to decelerate from maximum frequency (P1.2) to zero frequency. When decelerating from different frequency levels, the deceleration time will be a fraction of the total deceleration time.			
<p>The values for the acceleration time t_1 and the deceleration time t_2 are calculated as follows:</p> $t_1 = \frac{(\text{Max. Frequency} - \text{Min. Frequency}) \times \text{Accel. Time 1}}{\text{Max. Frequency}}$ $t_2 = \frac{(\text{Max. Frequency} - \text{Min. Frequency}) \times \text{Decel. Time 1}}{\text{Max. Frequency}}$ <p>① When setting a minimum output frequency (decal time greater than 0 Hz), the acceleration and deceleration time of the drive is reduced to t_1 or t_2</p>				
P1.13^②	Remote control place			ID 135
Minimum value:	N.A.	Maximum value:	N.A.	Default value: 0
Options:	0 = I/O terminal; 1 = Fieldbus; or 3 = Keypad.			
Description:	Selects where the drive will look for the start command in the remote location: I/O terminals would be from the digital hard-wired inputs; fieldbus would be a communication bus; and keypad display will indicate what mode is selected			
P1.14^{①②}	Remote reference			ID 137
Minimum value:	N.A.	Maximum value:	N.A.	Default value: 0
Options:	0 = AI; 1 = Drive reference pot; 2 = AI joystick; 3 = Motor pot; 4 = Maximum frequency; 5 = PI control output; 6 = Keypad; or 7 = Fieldbus reference.			
Description:	This parameter determines the reference for remote 1 control mode. This value can be fed from an analog input, keypad, or fieldbus reference signal			
P13.5.3	Keypad lock PIN			ID 75
Minimum value:	0	Maximum value:	9999	Default value: 0
Description:	<p>The keypad can be protected against unauthorized changes with the keypad lock function after no keys are pressed after five minutes.</p> <p>When the password function is enabled, the user will be prompted to enter a password before the keypad display parameter or response to key press except up/down/left/right.</p> <p>By default, the password function is not in use. If you want to activate the password, change the value of this parameter to any number between 1 and 9999.</p> <p>To deactivate the password, reset the parameter value to 0.</p>			

Table 5. Start-up wizard instructions (Cont.).

P11.6.1	<i>Blue tooth enabled</i>			ID 1895
Minimum value:	N.A.	Maximum value:	N.A.	Default value: N.A.
Options:	0 = Disabled; or 1 = Enable.			
Description:	Blue tooth enable.			

① Parameter value can only be changed after the drive has stopped.

② Parameter value will be set to be default when changing macros.

Now the Start-up Wizard is done. It will not show again at the next power up. If you want to reset it, please select it from the main menu ("Start-up Wizard").

The PID Mini-Wizard is activated in the Quick Setup menu

Chapter 4 - Standard

On the next pages you will find the lists of parameters within the respective parameter groups. Each parameter section within the table lists:

- Parameter code (location indication on the keypad; shows the operator the present parameter number);
- Parameter name;
- ID (number of the parameter);

and where applicable:

- Minimum value and units;
- Maximum value and units;
- Default value and units;
- Options (when available); and
- Description of the parameter.

Table 6. Monitor.

M1 - standard.				
M1.1	<i>Output frequency</i>			ID 1
Minimum value:	Hz	Maximum value:	Hz	Default value: Hz
Description:	Output frequency (Hz).			
M1.2	<i>Frequency reference</i>			ID 24
Minimum value:	Hz	Maximum value:	Hz	Default value: Hz
Description:	Reference frequency (Hz).			
M1.3	<i>Motor speed</i>			ID 2
Minimum value:	rpm	Maximum value:	rpm	Default value: rpm
Description:	Motor output speed (rpm).			
M1.4	<i>Motor current</i>			ID 3
Minimum value:	A	Maximum value:	A	Default value: A
Description:	Motor output current RMS (Amps).			
M1.5	<i>Motor torque</i>			ID 4
Minimum value:	%	Maximum value:	%	Default value: %
Description:	Percent motor torque calculated from nameplate values and measured motor current (%).			
M1.6	<i>Motor power</i>			ID 5
Minimum value:	%	Maximum value:	%	Default value: %
Description:	Percent motor power calculated from nameplate values and measured motor current (%).			
M1.7	<i>Motor voltage</i>			ID 6
Minimum value:	V	Maximum value:	V	Default value: V
Description:	Output ac motor voltage (Vac).			
M1.8	<i>DC-link voltage</i>			ID 7
Minimum value:	V	Maximum value:	V	Default value: V
Description:	DC bus voltage (Vdc).			
M1.9	<i>Unit temperature</i>			ID 8
Minimum value:	°C	Maximum value:	°C	Default value: °C
Description:	Heat sink temperature (deg C).			

Table 6. Monitor (Cont.).

M1 - standard (Cont.).					
M1.10	Motor temperature				ID 9
Minimum value:	%	Maximum value:	%	Default value:	%
Description:	Motor temperature value calculated from nameplate values and measured motor current (%).				
M1.11	Latest fault code				ID 28
Minimum value:	N.A.	Maximum value:	N.A.	Default value:	N.A.
Description:	Last active fault code value. See fault codes for the value shown here.				
M1.12	Instant motor power				ID 1686
Minimum value:	kW	Maximum value:	kW	Default value:	kW
Description:	Instantaneous motor power (kW).				
M2 - I/O status.					
M2.1	Analog input 1				ID 10
Minimum value:	Varies	Maximum value:	Varies	Default value:	Varies
Description:	Analog input 1 measured value (Vdc or Amps) selectable with dipswitch.				
M2.2	Keypad pot voltage				ID 1858
Minimum value:	V	Maximum value:	V	Default value:	V
Description:	Keypad potentiometer measured value (Vdc). DM1 PRO only.				
M2.3	Analog output				ID 25
Minimum value:	Varies	Maximum value:	Varies	Default value:	Varies
Description:	Analog output 1 measured value (Vdc or Amps) selectable with parameter.				
M2.4	DI1, DI2, DI3				ID 12
Minimum value:	N.A.	Maximum value:	N.A.	Default value:	N.A.
Description:	Digital input 1/2/3 status.				
M2.5	DI4				ID 13
Minimum value:	N.A.	Maximum value:	N.A.	Default value:	N.A.
Description:	Digital input 4 status.				
M2.8	RO1, RO2				ID 557
Minimum value:	N.A.	Maximum value:	N.A.	Default value:	N.A.
Description:	Relay output 1 and 2 4 status.				
M5 - PI monitor.					
M5.1	PI set point				ID 16
Minimum value:	Varies	Maximum value:	Varies	Default value:	Varies
Description:	PI set point in process units.				
M5.2	PI feedback				ID 18
Minimum value:	Varies	Maximum value:	Varies	Default value:	Varies
Description:	PI feedback level in process units.				
M5.3	PI error value				ID 20
Minimum value:	Varies	Maximum value:	Varies	Default value:	Varies
Description:	PI error in process units.				
M5.4	PI output				ID 22
Minimum value:	%	Maximum value:	%	Default value:	%
Description:	PI output.				

Table 6. Monitor (Cont.).

M5.5	PI status				ID 23
Minimum value:	N.A.	Maximum value:	N.A.	Default value:	N.A.
Options:	0 = Stopped; 1 = Running; or 2 = Sleep mode.				
Description:	PI status indication, indicates if drive is stopped, running in PI mode, or in PI sleep mode.				
M9 - Multi-monitoring.					
M9.1	Multi-monitoring				ID 30
Minimum value:	N.A.	Maximum value:	N.A.	Default value:	0, 1, 2.
Description:	Displays any three monitoring values in a single screen. The values are selectable via the keypad menu. Multi-monitor page could see three lines of monitoring values. Up and down keys can be used to select the row and then hitting the left arrow key will allow for editing the value then by going up and down.				

Table 7. Operate mode - O.

Code	Parameter	Min.	Max.	Unit	Default	ID	Note
01	Output frequency			Hz		1	
02	Freq. reference			Hz		24	
03	Motor speed			rpm		2	
04	Motor current			A		3	
05	Motor torque			%		4	
06	Motor power			%		5	
07	Motor voltage			V		6	
08	DC-link voltage			V		7	
09	Unit temperature			°C		8	
010	Motor temperature			%		9	
R11 [Ⓢ]	Keypad reference	<i>Minimum frequency</i>	<i>Maximum frequency</i>	Hz	0.00	141	
R12 [Ⓢ]	PI keypad setpoint 1	<i>PI process minimum</i>	<i>PI process maximum</i>	Varies	0.00	1307	

[Ⓢ] Parameter value will be set to be default when changing macros.

Table 8. Parameters .

P1 - Basic parameters.					
P1.1[Ⓢ]	Minimum frequency				ID 101
Minimum value:	0.00 Hz	Maximum value:	400.00 Hz	Default value:	0.00 Hz
Description:	Defines the lowest frequency at which the drive will operate. This setting will limit other frequency parameter settings. 1 = Fire mode minimum frequency. 2 = Derag. 3 = MPFC staging frequency. 4 = MPFC master fixed frequency. 5 = Prime pump frequency. 6 = Prime pump frequency 2.				

Table 8. Parameters (Cont.).

P1.2^②	Maximum frequency			ID 102
Minimum value:	0.00 Hz	Maximum value:	400.00 Hz	Default value: MaxFreqMFG
Description:	Defines the highest frequency at which the drive will operate. This will limit other frequency parameters. 1 = Keypad reference. 3 = Motor potentiometer. 3 = Jog speed. 4 = 2nd stage ramp frequency. 5 = Fire mode minimum frequency. 6 = Derag. 7 = MPFC staging frequency. 8 = MPFC master fixed frequency. 9 = Prime pump frequency. 10 = Prime pump frequency 2. 11 = Preset speed frequency. 12 = Frequency limit value. 13 = Reference limit value. 14 = Speed control_fs2. 15 = Stall frequency limit. 16 = 4 mA fault frequency. 17 = MPFC de-staging frequency. 18 = Pipe fill loss frequency low. 19 = Pipe fill loss frequency high. 20 = Broken pipe frequency limit.			
P1.3^②	Accel. time 1			ID 103
Minimum value:	0.1 s	Maximum value:	3,000.0 s	Default value: 20.0 s
Description:	Defines the time required for the output frequency to accelerate from zero frequency to maximum frequency.			
P1.4^②	Decel. time 1			ID 104
Minimum value:	0.1 s	Maximum value:	3,000.0 s	Default value: 20.0 s
Description:	Defines the time required for the output frequency to decelerate from maximum frequency to zero frequency.			
P1.6^①	Motor nom. current			ID 486
Minimum value:	DriveNomCurrCT*1/10 A	Maximum value:	DriveNomCurrCT*2 A	Default value: DriveNomCurrCT A
Description:	Motor nameplate rated full load current. This value is found on the rating plate of the motor.			
P1.7^①	Motor nom. speed			ID 489
Minimum value:	300 rpm	Maximum value:	20,000 rpm	Default value: MotorNomSpeedMFG
Description:	Motor nameplate rated speed. This value is found on the rating plate of the motor.			
P1.8^①	Motor PF			ID 490
Minimum value:	0.30	Maximum value:	1.00	Default value: 0.85
Description:	Motor nameplate rated power factor. This value is found on the rating plate of the motor.			
P1.9^①	Motor nom. voltage			ID 487
Minimum value:	180 V	Maximum value:	690 V	Default value: MotorNomVoltMFG V
Description:	Motor nameplate rated voltage. This value is found on the rating plate of the motor.			
P1.10^①	Motor nom. frequency			ID 488
Minimum value:	8.00 Hz	Maximum value:	400.00 Hz	Default value: MotorNomFreqMFG Hz
Description:	Motor nameplate rated frequency. This value is found on the rating plate of the motor.			
P1.11^②	Local control place			ID 1695
Minimum value:	N.A.	Maximum value:	N.A.	Default value: 0
Options:	0 = keypad; 1 = I/O terminal; or 3 = fieldbus.			
Description:	Defines the signal location for the start command in local mode. I/O terminals would be from the digital hard-wired inputs or keypad for Start/Stop buttons on the drive. Keypad display will indicate which mode is selected.			

Table 8. Parameters (Cont.).

P1.12^{①②}	Local reference			ID 136
Minimum value:	N.A.	Maximum value:	N.A.	Default value: 1
Options:	0 = AI; 1 = drive ref. pot; 4 = maximum frequency; 6 = keypad; or 7 = fieldbus ref.			
Description:	Defines the signal location for the speed reference in local mode.			
P1.13^②	Remote control place			ID 135
Minimum value:	N.A.	Maximum value:	N.A.	Default value: 0
Options:	0 = I/O terminal; 1 = fieldbus; or 3 = keypad.			
Description:	Defines the signal location for the start command in remote mode. I/O terminals would be from the digital hard-wired inputs or keypad for Start/Stop buttons on the drive. Keypad display will indicate which mode is selected.			
P1.14^{①②}	Remote reference			ID 137
Minimum value:	N.A.	Maximum value:	N.A.	Default value: 0
Options:	0 = AI; 1 = drive reference pot; 4 = maximum frequency; 6 = keypad; or 7 = fieldbus reference.			
Description:	Defines the signal location for the speed reference in remote mode.			

① Parameter value can only be changed after the drive has stopped.

② Parameter value will be set to be default when changing macros.

Table 9. Inputs.

P2.1 - Basic settings.

P2.1.3^{①②}	IO terminal Start/Stop logic			ID 143
Minimum value:	N.A.	Maximum value:	N.A.	Default value: 0
Options:	0 = Forward - reverse: maintained input on start signal 1 to run forward and a maintained signal on start signal 2 for reverse. 1 = Start - reverse: maintained input on start signal 1 to run forward and a maintained signal on start signal 2 for reverse. 2 = Start - enable: maintained input on start signal 1 to run forward and a maintained signal on start signal 2 to enable the drive to run. 3 = Start pulse - Stop pulse: used for three wire operation. Start signal 1 uses a normally open start and start signal 2 uses a normally closed stop.			
Description:	Defines the functionality for start signal 1 and start signal 2. By default, start signal 1 is DI1 and start signal 2 is DI2. 0 = P3.2: DI closed contact = start forward P3.3: DI closed contact = start reverse. This would be considered 2-wire control with either a contact used on the start FWD or start REV commands. When contacts open, the motor stops.			

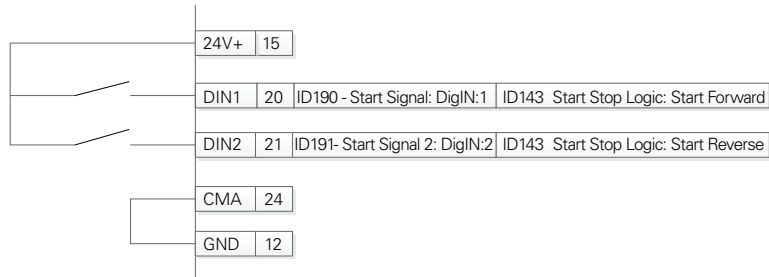
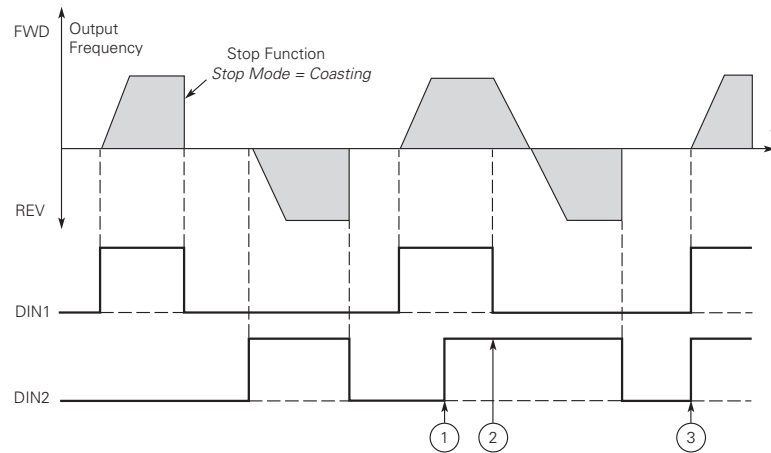

Table 9. Inputs (Cont.)



- Notes:**
- ① The first selected direction has the highest priority.
 - ② When the DIN1 contact opens the direction of rotation starts to change.
 - ③ If start forward (DIN1) and start reverse (DIN2) signals are active simultaneously the start forward signal (DIN1) has priority.

1 = P3.2: DI closed contact = start /open contact = stop P3.3: DI closed contact = reverse / open contact = forward. This would be considered 2-wire control with a contact on start/stop, contact open it stops and direction on 2nd start signal.

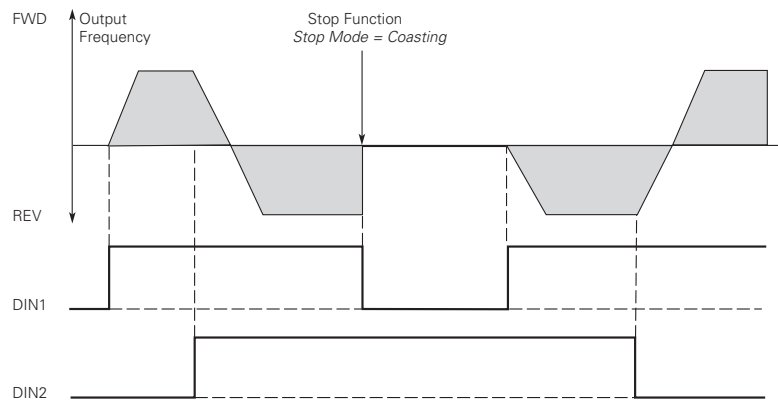
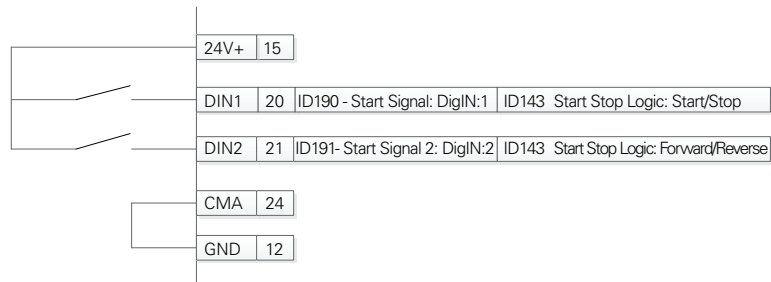
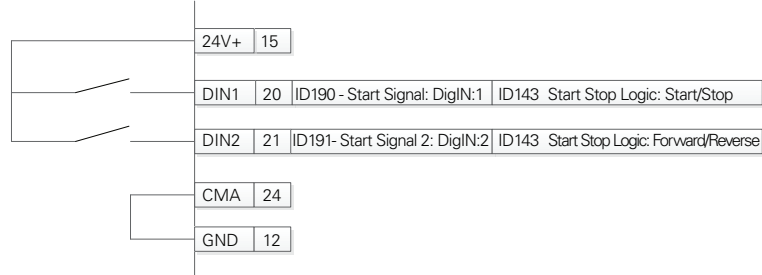

Table 9. Inputs (Cont.).

2 = P3.2: DI closed contact = start/open contact = stop P3.3: DI closed contact = start enabled/open contact = start disabled and drive stopped if running motor direction keeps forward. This would be considered 3-wire control with start signal 2 required to be closed to enable start on start signal 1.



3 = Three-wire connection (pulse control): P3.2: DI changes from open to closed = start pulse P3.3: DI changes from closed to open = stop pulse P3.5: DI closed contact = reverse/open contact = forward. This would be considered 3-wire control with start signal 1 being the start pulse and start signal 2 being the NC stop.

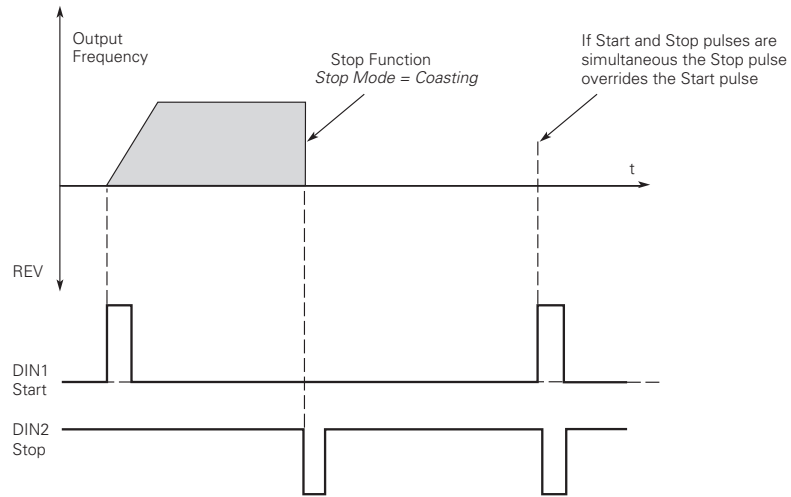
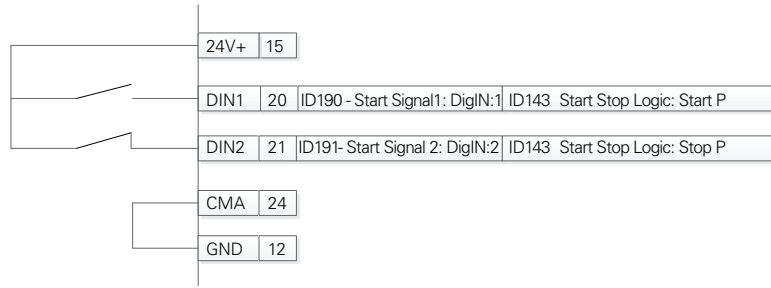

Table 9. Inputs (Cont.).

P2.2 - Digital input.					
P2.2.5[®]	DI3 function				ID 1805
Minimum value:	N.A.	Maximum value:	N.A.	Default value:	4
Options:	0 = Not used, no action. 1 = IO terminal start signal 1 - when the control source is set to IO terminal, this input when closed will perform the action defined by P2.1.3. 2 = IO terminal start signal 2 - when the control source is set to IO terminal, this input when closed will perform the action defined by P2.1.3. 3 = Reverse - when Start/Stop logic is set to 3 start pulse stop pulse, this input will cause the drive to start in the reverse direction. 4 = Ext. fault 1 - when closed, ext. fault 1 will be activated. 7 = Fault reset - when closed, all active faults will be reset. 8 = Run enable - when closed the drive will allow a start command and be in the ready state. 9 = Preset speed B0 - the seven preset speeds are selected via three binary inputs, this is least significant bit in that binary input. 10 = Preset speed B1 - the seven preset speeds are selected via three binary inputs. 11 = Preset speed B2 - the seven preset speeds are selected via three binary inputs, this is most significant bit in that binary input. 16 = Accel./decel. time set - when open, accel./decel. time 1 will be used, when closed accel./decel. time 2 will be used. 19 = Remote control - when closed, the drive will be forced to the remote control place. 20 = Local control - when closed, the drive will be forced to the local control place. 22 = PI controller - when closed, the drive will force the reference source to PI controller output. 23 = PI setpoint select - when open, parameter setpoint 1 is active, when closed, setpoint 2 is active. 24 = Motor interlock 1 - when closed, motor will be enabled to run. 29 = DC brake active - when closed, DC injection braking will be active. 31 = Derag. enable - when closed. The Derag. cycle for pumps will be initiated.				
Description:	Defines the function of digital input 3.				
P2.2.7[®]	DI4 function				ID 1807
Minimum value:	N.A.	Maximum value:	N.A.	Default value:	7
Options:	0 = Not used, no action. 1 = IO terminal start signal 1 - when the control source is set to IO terminal, this input when closed will perform the action defined by P2.1.3. 2 = IO terminal start signal 2 - when the control source is set to IO terminal, this input when closed will perform the action defined by P2.1.3. 3 = Reverse - when Start/Stop logic is set to 3 start pulse stop pulse, this input will cause the drive to start in the reverse direction. 4 = Ext. fault 1 - when closed, ext. fault 1 will be activated. 7 = Fault reset - when closed, all active faults will be reset. 8 = Run enable - when closed the drive will allow a start command and be in the ready state. 9 = Preset speed B0 - the seven preset speeds are selected via three binary inputs, this is least significant bit in that binary input. 10 = Preset speed B1 - the seven preset speeds are selected via three binary inputs. 11 = Preset speed B2 - the seven preset speeds are selected via three binary inputs, this is most significant bit in that binary input. 16 = Accel./decel. time set - when open, accel./decel. time 1 will be used, when closed accel./decel. time 2 will be used. 19 = Remote control - when closed, the drive will be forced to the remote control place. 20 = Local control - when closed, the drive will be forced to the local control place. 22 = PI controller - when closed, the drive will force the reference source to PI controller output. 23 = PI setpoint select - when open, parameter setpoint 1 is active, when closed, setpoint 2 is active. 24 = Motor interlock 1 - when closed, motor will be enabled to run. 29 = DC brake active - when closed, DC injection braking will be active. 31 = Derag. enable - when closed. The Derag. cycle for pumps will be initiated.				
Description:	Defines the function of digital input 4.				
P2.3 - Preset speed.					
P2.3.1[®]	Preset speed 1				ID 105
Minimum value:	0.00 Hz	Maximum value:	MaxFreq Hz	Default value:	5.00 Hz
Description:	Preset speed is selected with digital inputs using a binary input.				
P2.3.2[®]	Preset speed 2				ID 106
Minimum value:	0.00 Hz	Maximum value:	MaxFreq Hz	Default value:	10.00 Hz
Description:	Preset speed is selected with digital inputs using a binary input.				
P2.3.3[®]	Preset speed 3				ID 118
Minimum value:	0.00 Hz	Maximum value:	MaxFreq Hz	Default value:	15.00 Hz
Description:	Preset speed is selected with digital inputs using a binary input.				

Table 9. Inputs (Cont.).

P2.3.4 ^②	Preset speed 4			ID 119
Minimum value:	0.00 Hz	Maximum value:	MaxFreq Hz	Default value: 20.00 Hz
Description:	Preset speed is selected with digital inputs using a binary input.			
P2.3.5 ^②	Preset speed 5			ID 120
Minimum value:	0.00 Hz	Maximum value:	MaxFreq Hz	Default value: 25.00 Hz
Description:	Preset speed is selected with digital inputs using a binary input.			
P2.3.6 ^②	Preset speed 6			ID 121
Minimum value:	0.00 Hz	Maximum value:	MaxFreq Hz	Default value: 30.00 Hz
Description:	Preset speed is selected with digital inputs using a binary input.			
P2.3.7 ^②	Preset speed 7			ID 122
Minimum value:	0.00 Hz	Maximum value:	MaxFreq Hz	Default value: 35.00 Hz
Description:	Preset speed is selected with digital inputs using a binary input.			

P2.4 - AI settings.

P2.4.1	AI mode			ID 222
Minimum value:	N.A.	Maximum value:	N.A.	Default value: 1
Options:	0 = 0 - 20 mA; or 1 = 0 - 10 V.			
Description:	<p>Defines the analog input mode to current or voltage the DIP switches on control board will need to be set to the same mode as this parameter.</p> <p>*DM1 PRO CN5 terminals 8 and 9 for current or voltage, also need to set DIP switches SW2 2 and 3 on control board, near the RJ45 port.</p> <p>DIP switches SW2 2 and 3 off for voltage.</p> <p>Current mode, if using the +10 V supply on CN5 terminals 13 of the DM1 / DM1 Pro, it will require DIP switches SW2 2 and 3 on to complete the current loop. When doing a current loop with an external supply, the DIP switches SW2 2 off and 3 on.</p>			

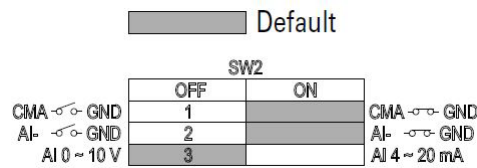
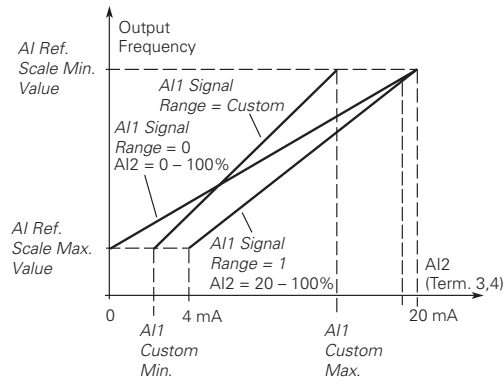

Table 9. Inputs (Cont.).

P2.4.2[ⓐ]	AI signal range			ID 175
Minimum value:	N.A.	Maximum value:	N.A.	Default value: 0
Options:	0 = 0-100%/0-20 mA/0-10 V. 1 = 20-100%/4-20 mA/2-10 V.			
Description:	With this parameter, you can select the analog input 1 signal range. For selection "Customized," see "AI Custom Min" and "AI Custom Max", this enables a customized signal range.			



[ⓐ] Parameter value can only be changed after the drive has stopped.
[ⓑ] Parameter value will be set to be default when changing macros.

Table 10. Outputs .

P3.1 - Digital output.				
P3.1.1[ⓐ]	RO1 function			ID 152
Minimum value:	N.A.	Maximum value:	N.A.	Default value: 2
Options:	0 = Not used - no action. 1 = Ready - drive is ready for operation. 2 = Run - drive is running. 3 = Fault - drive is faulted. 4 = Fault invert - drive is not faulted. 5 = Warning - drive has a warning message. 6 = Reverse - drive is outputting reverse phase rotation. 7 = At speed - output frequency has reached the set reference. 8 = Zero frequency - drive output is at zero frequency. 24 = STO fault output - safe torque off input is activated. 26 = Remote control - remote is the control place. 37 = PI sleep - PI controller is in a sleep state.			
Description:	Defines the function associated with changing the state of relay output 1.			
P3.1.4[ⓐ]	RO2 function			ID 153
Minimum value:	N.A.	Maximum value:	N.A.	Default value: 3
Options:	0 = Not used - no action. 1 = Ready - drive is ready for operation. 2 = Run - drive is running. 3 = Fault - drive is faulted. 4 = Fault invert - drive is not faulted. 5 = Warning - drive has warning message. 6 = Reverse - drive is outputting reverse phase rotation. 7 = At speed - output frequency has reached the set reference. 8 = Zero frequency - drive output is at zero frequency. 24 = STO fault output - safe torque off input is activated. 26 = Remote control - remote is the control place. 37 = PI sleep - PI controller is in a sleep state.			
Description:	Defines the function associated with changing the state of relay output 2.			

Table 10. Outputs (Cont.).

P3.3 - Analog output.				
P3.3.1 ^②	AO mode			ID 227
Minimum value:	N.A.	Maximum value:	N.A.	Default value: 0
Options:	0 = 0 - 20 mA; or 1 = 0 - 10 V.			
Description:	Defines the analog output mode to current or voltage.			
P3.3.2 ^②	AO function			ID 146
Minimum value:	N.A.	Maximum value:	N.A.	Default value: 1
Options:	1 = Output frequency (0 - maximum frequency). 2 = Frequency reference (0 - max frequency). 3 = Motor speed rpm (0 - nameplate rpm). 4 = Motor current (0 - nameplate current). 5 = Motor torque (0 - calculated nominal). 6 = Motor power (0 - calculated nominal). 7 = Motor voltage (0 - nameplate voltage). 8 = DC bus voltage (0 - 1,000 Vdc). 12 = Analog input (0% - 100%).			
Description:	Select the function desired to the terminal AO1.			

② Parameter value will be set to be default when changing macros.

Table 11. Drive control.

P4.1 - Basic settings.				
P4.1.1 ^②	Keypad reference			ID 141
Minimum value:	MinFreq	Maximum value:	MaxFreq	Default value: 0.00 Hz
Description:	Keypad reference value.			
P4.1.3 ^②	Keypad stop			ID 114
Minimum value:	N.A.	Maximum value:	N.A.	Default value: 1
Options:	0 = Enabled - keypad operation - In this mode, the keypad stop will only operate when the control source is set to keypad. 1 = Always enabled - In this mode, the stop button will always stop the drive regardless of control mode.			
Description:	Enabled or always enabled keypad operation.			
P4.1.4 ^①	Reverse enabled			ID 1679
Minimum value:	N.A.	Maximum value:	N.A.	Default value: 1
Options:	0 = Disabled; or 1 = Enabled.			
Description:	Enables or disables the reverse motor direction.			
P4.1.5	Change phase sequence motor			ID 2515
Minimum value:	N.A.	Maximum value:	N.A.	Default value: 0
Options:	0 = Change disable; or 1 = Change enable.			
Description:	This parameter allows for swapping the motor phase output from u, v, w to u, w, v.			
P4.1.6 ^②	Power up local remote select			ID 1685
Minimum value:	N.A.	Maximum value:	N.A.	Default value: 0
Options:	0 = Hold last; 1 = Local control; or 2 = Remote control.			
Description:	Selects what control place the drive will start at after power is applied. The default setting will hold the last state that the drive was in when powered down, selecting Local or Remote will cause the drive to start in that mode regardless of last state.			

Table 11. Drive control (Cont.).

P4.1.8^②	Start mode			ID 252
Minimum value:	N.A.	Maximum value:	N.A.	Default value: 0
Options:	0 = Ramp - The drive starts from 0 Hz and ramps to the frequency reference value. 1 = Flying start from stop frequency - The drive will catch a spinning motor. This setting searches for the current frequency using the last operating frequency as a starting point. 2 = Flying start from maximum frequency - The drive will catch a spinning motor. This setting searches for the current frequency using the maximum operating frequency as a starting point.			
Description:	Selects the start mode operation.			
P4.1.9^②	Stop mode			ID 253
Minimum value:	N.A.	Maximum value:	N.A.	Default value: 1
Options:	0 = Coasting - After a stop command, the motor coasts to a stop uncontrolled by the drive. 1 = Ramp - After the stop command, the speed of the motor is decelerated according to the set deceleration parameters.			
Description:	Selects the stop mode operation.			
P4.1.10^②	Ramp 1 shape			ID 247
Minimum value:	0.0 s	Maximum value:	10.0 s	Default value: 0.0 s
Description:	The start and end of the acceleration and deceleration ramps can be smoothed with these parameters. Setting a value of 0.00 seconds gives a linear ramp shape that causes acceleration and deceleration to react immediately to the changes in the reference signal. Setting a value from 0.10 to 10.00 seconds for this parameter produces an S-shaped acceleration/deceleration at the start and stop of the slope.			

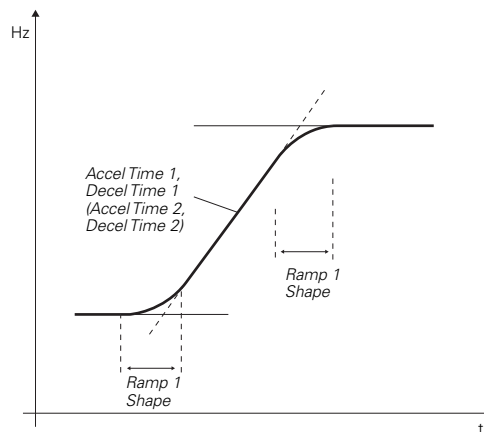

① Parameter value can only be changed after the drive has stopped.
 ② Parameter value will be set to be default when changing macros.

Table 12. Motor control.

P5.1 - Basic settings.				
P5.1.1^{①②}	Motor control mode			ID 287
Minimum value:	N.A.	Maximum value:	N.A.	Default value: 0
Options:	0 = Frequency control - Output frequency is controlled directly by the frequency reference. 1 = Speed control - Output frequency is controlled by giving a frequency reference to it with slip compensation. 2 = Open loop vector control - Similar to the standard speed control mode, higher performance slip calculation requires running a motor identification. 3 = PM control 1 - PM motor control mode 1, used for SPM (surface mounted permanent magnet) and it also can be used for IPM. 4 = PM control 2 - PM motor control mode 2, used for IPM (internally mounted permanent magnet) and it can not be used for SPM.			
Description:	Selects the motor control mode.			

Table 12. Motor control (Cont.).

P5.1.2^①	Current limit			ID 107
Minimum value:	DriveNomCurrCT*1/10 A	Maximum value:	DriveNomCurrCT*2 A	Default value: DriveNomCurrCT*3/2 A
Description:	This parameter determines the maximum output current allowed from the drive. The parameter value range differs from size to size. Once the motor current hits this level, it goes into the current limiter controller and tries to limit the output current.			
P5.1.3^{①②}	V/Hz optimization			ID 109
Minimum value:	N.A.	Maximum value:	N.A.	Default value: 0
Options:	0 = Disable torque boost function. 1 = Enable torque boost function.			
Description:	Automatic torque boost - the voltage to the motor increases automatically, which assists the motor to produce sufficient torque to start and run at low frequencies with high loads.			
P5.1.4^{①②}	V/Hz ratio			ID 108
Minimum value:	N.A.	Maximum value:	N.A.	Default value: 0
Options:	0 = Linear - the voltage of the motor changes linearly with the frequency in the constant flux area from 0 Hz to the field weakening point where the nominal voltage is supplied. A linear V/Hz ratio should be used in constant torque applications. 1 = Squared - the voltage of the motor changes following a squared curve with the frequency in the area from 0 Hz to the field weakening point where the nominal voltage is supplied. The motor runs under magnetized below the field weakening point and produces less torque and electromechanical noise. A squared V/Hz ratio can be used in applications where the torque demand of the load is proportional to the square of the speed. 2 = Programmable V/Hz curve - the V/Hz curve can be programmed with three different points. These points are the 0 frequency voltage, midpoint, and weakening point. A programmable V/Hz curve can be used if the other settings do not satisfy the needs of the application. 3 = Linear with flux optimization - the drive starts to search for the minimum motor current in order to save energy. This mode is called Eaton's Active Energy Control which will reduce the voltage and current but still maintain the desired speed.			
Description:	Selects the V/Hz ratio. 0 = Linear; 1 = Squared; 2 = Programmable; or 3 = Linear + flux optimization.			

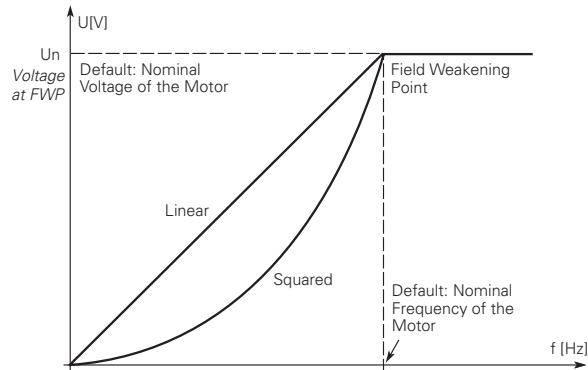

P5.1.10^②	Switching frequency			ID 288
Minimum value:	MinSwitchFreq kHz	Maximum value:	MaxSwitchFreq kHz	Default value: DefaultSwitchFreqCT kHz
Description:	Sets the switching frequency for the PWM output waveform.			
P5.1.16^{①②}	Identification			ID 299
Minimum value:	N.A.	Maximum value:	N.A.	Default value: 0
Options:	0 = Not action. 1 = Identification only stator resistor - does not spin the motor. This can be done with load attached. 2 = Identification with run - motor stator resistor is completed then the motor is run. This must be completed with unloaded motor. 3 = Identification no run - motor is supplied with current and voltage but at zero frequency. 4 = Identification only inertia - identification for the system inertia only.			
Description:	This parameter enables the drive to make an motor identification cycle of the motor once complete the drive will adjust tuning parameters to improve starting torque and open loop vector control performance. Once set and a run command is given, the operation will be active then set back to 0 when completed. When a run command is issued, the message on the keypad will indicate "Auto tuning" is being performed. If there is an issue with the motor identification, a fault message will be displayed.			

① Parameter value can only be changed after the drive has stopped.

② Parameter value will be set to be default when changing macros.

Table 13. Protections.

P6.1 - Motor.				
P6.1.4^{①②}	Motor thermal protection			ID 310
Minimum value:	N.A.	Maximum value:	N.A.	Default value: 2
Options:	0 = No response. 1 = Warning. 2 = Fault, stop mode after fault according to parameter stop mode. 3 = Fault, stop mode after fault always by coasting.			
Description:	If a fault condition is selected, the drive will stop and activate the fault stage based off the % of calculated motor temperature. The calculated motor temp is based off the install power on values of the drive and monitoring values as the drive is running. Deactivating this protection, i.e., setting parameter to 0, will reset the thermal stage of the motor to 0%.			
P6.1.5^②				
Motor thermal FO current				
Minimum value:	0.00%	Maximum value:	150.00%	Default value: 100.00%
Description:	The current can be set between 0 - 150.0% x InMotor. This parameter sets the value for thermal current at zero frequency. The default value is set assuming that there is no external fan cooling the motor. If an external fan is used, this parameter can be set to 90% (or even higher).			
	<p>Note: The value is set as a percentage of the motor nameplate data, P1.6 (nominal current of the motor), not the drive's nominal output current. The motor's nominal current is the current that the motor can withstand in direct on-line use without being overheated. If you change the parameter nominal current of motor, this parameter is automatically restored to the default value. Setting this parameter does not affect the maximum output current of the drive.</p>			
P6.2 - Drive.				
P6.2.2^{①②}	Input phase fault			ID 332
Minimum value:	N.A.	Maximum value:	N.A.	Default value: 2
Options:	0 = No response; 1 = Warning; 2 = Fault, stop mode after fault according to parameter stop mode; 3 = Fault, stop mode after fault always by coasting; or 4 = Single phase power limit.			
Description:	The input phase supervision ensures that the input phases of the frequency converter have approximately equal current draw.			
P6.2.3^{①②}				
4 mA input fault				
Minimum value:	N.A.	Maximum value:	N.A.	Default value: 0
Options:	0 = No response. 1 = Warning. 2 = Warning, the frequency from 10 seconds back is set as reference. 3 = Warning, the preset frequency P6.2.4 is set as reference. 4 = Fault, stop mode after fault according to parameter stop mode. 5 = Fault, stop mode after fault always by coasting.			
Description:	A warning or a fault action and message is generated if the 4 - 20 mA reference signal is used and the signal falls below 4 mA for 5 seconds, or below 0.5 mA for 0.5 seconds. The information can also be programmed into relay outputs RO1 and RO2.			

Table 13. Protections (Cont.).

P6.2.4^{①②}	4 mA fault frequency			ID 331
Minimum value:	0.00 Hz	Maximum value:	MaxFreq Hz	Default value: 0.00
Description:	When 4 mA fault happens, the output frequency of drive goes to this preset speed when P6.2.3 = 3.			
P6.2.5^{①②}	External fault			ID 307
Minimum value:	N.A.	Maximum value:	N.A.	Default value: 2
Options:	0 = No action; 1 = Warning; 2 = Fault, stop mode after fault according to parameter stop mode. 3 = Fault, stop mode after fault always by coasting.			
Description:	A warning or a fault action and message is generated from the external fault signal in the programmable (digital inputs function select external fault). The status information can also be programmed into digital output relay outputs R01 and R02.			
P6.2.11^②	STO fault response			ID 2427
Minimum value:	N.A.	Maximum value:	N.A.	Default value: 2
Options:	0 = No Action - drive will stop, no indication shown, no reset required, have to cycle start command. 1 = Warning - drive indicate warning/if STO clears drive will run without reset. 2 = Fault - drive will indicate fault/require reset to start again.			
Description:	STO fault response defines the function of how the STO input will be seen on the keypad and how the drive functions to it.			
P6.2.12^①	PI feedback AI loss response			ID 2401
Minimum value:	N.A.	Maximum value:	N.A.	Default value: 0
Options:	0 = No action; 1 = Warning; 2 = Fault; or 3 = Warning: preset frequency (P6.2.13).			
Description:	This parameter defines the function of the PI feedback analog input loss response. If the AI feedback is lost based off the programed AI feedback.			
P6.2.13^{①②}	PI feedback AI loss pre-frequency			ID 2402
Minimum value:	0.00 Hz	Maximum value:	400.00 Hz	Default value: 0.00 Hz
Description:	This parameter defines the frequency the master would run to if a feedback is lost and P6.2.12 was set to option 3.			
P6.2.14^②	PI feedback AI loss pipe fill			ID 2403
Minimum value:	0.00 varies	Maximum value:	1000.00 varies	Default value: 0.00 varies
Description:	Detects loss of prime in the pump based off the measured level. If the value drops below this level for the time in P6.2.15 and below, the frequency in P6.2.13 "loss of prime" occurs.			
P6.2.15^②	PI feedback AI loss pre-frequency timeout			ID 2404
Minimum value:	0.0 s	Maximum value:	6,000.0 s	Default value: 0.0 s
Description:	PI feedback AI loss pre-frequency timeout - when P6.2.12 is set to 3 or 4, when the feedback signal is lost, the drive will run at the frequency in P6.2.15 for the time set here. After this time, the drive will fault out on "feedback loss". The time is disabled when set to 0 seconds.			
P6.3 - Communications.				
P6.3.1^{①②}	Fieldbus fault response			ID 334
Minimum value:	N.A.	Maximum value:	N.A.	Default value: 2
Options:	0 = No action; 1 = Warning; 2 = Fault; or 3 = Fault, coast.			
Description:	This sets the response mode for the fieldbus fault when a fieldbus mode is used and communication is lost between the PLC and communication port. Each protocol has another parameter to select in all control or only in fieldbus control to set fault or warning.			

Table 13. Protections (Cont.).

P6.3.2^{①②}	OPTcard fault response			ID 335
Minimum value:	N.A.	Maximum value:	N.A.	Default value: 2
Options:	0 = No action; 1 = Warning; 2 = Fault; or 3 = Fault, coast.			
Description:	This sets the response mode for a board slot fault caused by a missing or failed option board not communicating to the central processor.			

① Parameter value can only be changed after the drive has stopped.

② Parameter value will be set to be default when changing macros.

Table 14. PI Controller.

P7.1 - Basic settings.				
P7.1.1^②	PI control gain			ID 1294
Minimum value:	0.00%	Maximum value:	200.00%	Default value: 100.00%
Description:	Defines the gain of the PI Controller. It adjust the slope of the speed increase according to the initial of the load. If this value is set to 100%, a change of 10% in the error value causes the controller output to change 10%.			
P7.1.2^②	PI control itime			ID 1295
Minimum value:	0.00 s	Maximum value:	600.00 s	Default value: 1.00 s
Description:	Defines the integration time of the PI controller. Over the time, the integral time contributes to the deviation between the reference and the feedback signal. If this value is set to 1.00 sec., a change of 10% in the error value causes the controller output to change by 10.00%/s.			

Table 14. PI Controller (Cont.).

P7.1.3^{①②}	PI process unit			ID 1297
Minimum value:	N.A.	Maximum value:	N.A.	Default value: 0
Options:	0 = %; 1 = 1/min.; 2 = rpm; 3 = ppm; 4 = pps; 5 = l/s; 6 = l/min.; 7 = l/h; 8 = kg/s; 9 = kg/min.; 10 = kg/h; 11 = m ³ /s; 12 = m ³ /min.; 13 = m ³ /h; 14 = m/s; 15 = mbar; 16 = bar; 17 = Pa; 18 = kPa; 19 = mV/S; 20 = kW; 21 = Deg. C; 22 = GPM; 23 = gal/s; 24 = gal/min.; 25 = gal/h; 26 = lb/s; 27 = lb/min.; 28 = lb/h; 29 = CFM; 30 = ft ³ /s; 31 = ft ³ /min.; 32 = ft ³ /h; 33 = ft/s; 34 = in. wg; 35 = ft wg; 36 = PSI; 37 = lb/in.2; 38 = HP; 39 = Deg. F; 40 = PA; 41 = WC; 42 = HG; 43 = ft; 44 = m;			
Description:	Defines the unit type for PI feedback unit.			
P7.1.4^②	PI process unit minimum			ID 1298
Minimum value:	-99999.99 varies	Maximum value:	PI Process Unit Max	Default value: 0.00 varies
Description:	Defines the minimum process unit value.			
P7.1.5^②	PI process unit maximum			ID 1300
Minimum value:	PI Process Unit Min	Maximum value:	99999.99 varies	Default value: 100.00 varies
Description:	Defines the maximum process unit value.			
P7.1.6^{①②}	PI error inversion			ID 1303
Minimum value:	N.A.	Maximum value:	N.A.	Default value: 0
Options:	0 = Normal - if feedback is less than set-point, PI controller output increases. 1 = Inverted - if feedback is less than set-point, PI controller output decreases.			
Description:	Defines the way the process value output reacts to the feedback signal.			

① Parameter value can only be changed after the drive has stopped.

② Parameter value will be set to be default when changing macros.

Table 15. Setpoint.

P7.2.1 - Standard.					
P7.2.1.1 ^②	PI keypad setpoint 1				ID 1307
Minimum value:	PI Process Unit Min	Maximum value:	PI Process Unit Max	Default value:	0.00 varies
Description:	Keypad PI reference value set point 1.				
P7.2.1.3 ^③	PI wake-up action				ID 2466
Minimum value:	N.A.	Maximum value:	N.A.	Default value:	0
Options:	0 = Wake-up when below wake-up level. 1 = Wake-up when above wake-up-level. 2 = Wake-up when below wake-up level % from PI setpoint. 3 = Wake-up when above wake-up level %from PI setpoint.				
Description:	This parameter defines the wake-up function action.				
P7.2.2 - Setpoint 1.					
P7.2.2.1 ^①	PI setpoint 1 source				ID 1312
Minimum value:	N.A.	Maximum value:	N.A.	Default value:	1
Options:	0 = Not used; 1 = PI keypad setpoint 1; 2 = PI keypad setpoint 2; 3 = AI; 4 = Drive reference pot; 5 = FB process data input 1; 6 = FB process data input 2; 7 = FB process data input 3; 8 = FB process data input 4; 9 = FB process data input 5; 10 = FB process data input 6; 11 = FB process data input 7; 12 = FB process data input 8; 13 = FB PI setpoint 1; or 14 = FB PI setpoint 2.				
Description:	Defines source of the setpoint value the drive uses. This can either be an internal preset value, keypad setpoint, analog signal, or fieldbus message.				
P7.2.2.2 ^①	PI setpoint 1 sleep enable				ID 1315
Minimum value:	N.A.	Maximum value:	N.A.	Default value:	0
Options:	0 = Disabled; or 1 = Enabled.				
Description:	This function will disable the output when the frequency drops below the sleep frequency for the sleep delay time. The output re-engages when feedback rises above the wake-up level.				
P7.2.2.3 ^③	PI setpoint 1 sleep delay				ID 1317
Minimum value:	0 s	Maximum value:	3,000 s	Default value:	0 s
Description:	This parameter sets the delay time after the setpoint drops below the sleep level for this amount of time and then the drives output will shut off till the wake up level is met. It is to prevent large fluctuations when going into the sleep function to save motor run time.				
P7.2.2.4 ^③	PI setpoint 1 wake-up level				ID 1318
Minimum value:	-99999.99 varies	Maximum value:	99999.99 varies	Default value:	0.00 varies
Description:	Defines the level for the PI feedback value to go above top enable the PI output to be re enabled. This value is based of the % of feedback which can be scaled based off the PI unit min./max, values.				
P7.2.2.5 ^③	PI setpoint 1 boost				ID 1320
Minimum value:	-2.00 varies	Maximum value:	2.00 varies	Default value:	1.00 varies
Description:	The setpoint can be boosted via a multiplier value.				

Table 15. Setpoint (Cont.).

P7.2.2.6^①	PI setpoint 1 sleep level			ID 2450
Minimum value:	MinFreqMin Hz	Maximum value:	MaxFreq Hz	Default value: 0.00 Hz
Description:	Defines the level of which the unit value is used to look at to go into the sleep mode. When the unit drops below this level for the sleep delay time, it will put the drive into the sleep mode.			
P7.2.2.7^②	SP1 sleep mode over cycle time			ID 1842
Minimum value:	0	Maximum value:	10	Default value: 0
Description:	Defines the count the drive come in and out of sleep mode. If multiple times done in this time frame, the drive would trip on "pump over cycle" fault. One cycle is defined when the drive transfers from normal mode to sleep mode. 0 value means do not do the sleep over cycle check and clear "pump over cycle" fault.			
P7.2.2.8^②	SP1 sleep mode maximum cycle time			ID 1843
Minimum value:	0 s	Maximum value:	3,600 s	Default value: 300 s
Description:	Defines the maximum time for sleep over cycle checking.			

① Parameter value can only be changed after the drive has stopped.

② Parameter value will be set to be default when changing macros.

Table 16. Feedback.

P7.3.2 - Feedback 1.				
P7.3.2.1^①	PI feedback 1 source			ID 1332
Minimum value:	N.A.	Maximum value:	N.A.	Default value: 2
Options:	0 = Not used; 1 = AI; 2 = Drive reference pot; 3 = FB process data input 1; or 11 = FB PI feedback.			
Description:	Defines where feedback signal is being fed into the drive, via analog or fieldbus data value.			

① Parameter value can only be changed after the drive has stopped.

Table 17. Serial communication.

P11.1 - Basic settings.				
P11.1.1^①	Serial communication			ID 586
Minimum value:	N.A.	Maximum value:	N.A.	Default value: 0
Options:	0 = Modbus RTU; 1 = BACnet MSTP; or 2 = SWD.			
Description:	This parameter defines the communication protocol for RS-485.			
P11.2 - Modbus RTU.				
P11.2.1^①	Slave address			ID 587
Minimum value:	1	Maximum value:	247	Default value: 1
Description:	This parameter defines the slave address for RS-485 communication.			

Table 17. Serial communication (Cont.).

P11.2.2^①	Baud rate			ID 584
Minimum value:	N.A.	Maximum value:	N.A.	Default value: 1
Options:	0 = 9,600; 1 = 19,200; 2 = 38,400; 3 = 57,600; or 4 = 115,200			
Description:	This parameter defines communication speed for RS-485 communication.			
P11.2.3^①	Parity type			ID 585
Minimum value:	N.A.	Maximum value:	N.A.	Default value: 2
Options:	0 = None; 1 = Odd; or 2 = Even.			
Description:	This parameter defines parity type for RS-485 communication.			
P11.2.4	Modbus RTU protocol status			ID 588
Minimum value:	N.A.	Maximum value:	N.A.	Default value: N.A.
Options:	0 = Initial; 1 = Stopped; 2 = Operational; or 3 = Faulted.			
Description:	This parameter shows the protocol status for RS-485 communication.			
P11.2.5	Communication timeout modbus RTU			ID 593
Minimum value:	0 ms	Maximum value:	60,000 ms	Default value: 10,000 ms
Description:	Selects the time to wait before a communication fault occurs over modbus RTU if a message is not received.			
P11.2.6	Modbus RTU fault response			ID 2516
Minimum value:	N.A.	Maximum value:	N.A.	Default value: 0
Options:	0 - Only in fieldbus control mode. When fieldbus is the control place and fieldbus fault is active, the drive will fault on loss of communications; if not in fieldbus control, place will not fault. 1 - In all control modes. No matter the control place setting, if communication is lost, fieldbus fault response will occur.			
Description:	Defines the fieldbus fault condition for modbus RTU communication.			
P11.3 - BACnet RTU MSTP.				
P11.3.1^①	MSTP baud rate			ID 594
Minimum value:	N.A.	Maximum value:	N.A.	Default value: 2
Options:	0 = 9,600; 1 = 19,200; 2 = 38,400; 3 = 76,800; or 4 = 115,200.			
Description:	This parameter defines the communication speed for RS-485 communication.			
P11.3.2^①	MSTP device address			ID 595
Minimum value:	0	Maximum value:	127	Default value: 1
Description:	Defines the device address of the drive on the BACnet MSTP network.			
P11.3.3^①	MSTP instance number			ID 596
Minimum value:	0	Maximum value:	4,194,302	Default value: 0
Description:	Defines the instance number of the drive on the BACnet MSTP network.			
P11.3.4	MSTP communication timeout			ID 598
Minimum value:	0 ms	Maximum value:	60,000 ms	Default value: 10,000 ms
Description:	Selects the time to wait before a communication fault occurs over BACnet MSTP if a message is not received.			

Table 17. Serial communication (Cont.).

P11.3.5	MSTP protocol status			ID 599
Minimum value:	N.A.	Maximum value:	N.A.	Default value: N.A.
Options:	0 = Stopped; 1 = Operational; or 2 = Faulted.			
Description:	This parameter shows the protocol status for BACnet MSTP communication.			
P11.3.6	MSTP fault code			ID 600
Minimum value:	N.A.	Maximum value:	N.A.	Default value: N.A.
Options:	0 = None; 1 = Sole master; 2 = Duplicate MAC ID; or 3 = Baud rate fault.			
Description:	This parameter shows the protocol status for BACnet MSTP communication.			
P11.3.7	MSTP fault response			ID 2526
Minimum value:	N.A.	Maximum value:	N.A.	Default value: 0
Options:	0 = Only in fieldbus control mode - when fieldbus is the control place and fieldbus fault is active, the drive will fault on loss of communications. If not in fieldbus control, place will not fault. 1 = In all control modes - no matter the control place setting. If communication is lost, fieldbus fault response will occur.			
Description:	Defines the fieldbus fault condition for BACnet MSTP communication.			
P11.3.8	MSTP maximum master			ID 1537
Minimum value:	1	Maximum value:	127	Default value: 127
Description:	Defines the maximum number of masters that can establish connections with the drive.			
P11.4 - SA bus.				
P11.4.1^①	SA bus device address			ID 1726
Minimum value:	204	Maximum value:	254	Default value: 204
Description:	This parameter is used to set the SA bus address at which the drive will be located on instance node.			
P11.4.2^①	SA bus baud rate			ID 1727
Minimum value:	N.A.	Maximum value:	N.A.	Default value: 2
Options:	0 = 9,600; 1 = 19,200; 2 = 38,000; 3 = 57,600; or 4 = 115,200.			
Description:	This parameter defines communication speed for SA bus communication.			
P11.4.3^①	SA instance number			ID 1728
Minimum value:	0	Maximum value:	4,194,302	Default value: 0
Description:	Defines the instance number of the drive on the SA bus network.			
P11.4.4	SA communication timeout			ID 1730
Minimum value:	0	Maximum value:	60,000	Default value: 10,000
Description:	Selects the time to wait before a communication fault occurs over SA bus if a message is not received.			
P11.4.5	SA bus protocol status			ID 1731
Minimum value:	N.A.	Maximum value:	N.A.	Default value: N.A.
Options:	0 = Stopped; 1 = Operational; or 2 = Faulted.			
Description:	This parameter shows the protocol status for SA bus communication.			

Table 17. Serial communication (Cont.).

P11.4.6	SA bus fault response			ID 1732
Minimum value:	N.A.	Maximum value:	N.A.	Default value: 0
Options:	0 = Only in fieldbus control mode - when fieldbus is the control place and fieldbus fault is active. The drive will fault on loss of communications. If not in fieldbus control, place will not fault. 1 = In all control modes - no matter the control place setting, if communication is lost, fieldbus fault response will occur.			
Description:	Defines the fieldbus fault condition for SA bus communication.			
P11.5 - SWD.				
P11.5.1	Parameter access			ID 2630
Minimum value:	N.A.	Maximum value:	N.A.	Default value: 1
Options:	0 = No permission to read/write on acyclic channel. 1 = Acyclic read/write are allowed on Profibus.			
Description:	PNU927 which specifies the operation priority of parameters for acyclic communication.			
P11.5.2^①	Parameter data access			ID 2631
Minimum value:	N.A.	Maximum value:	N.A.	Default value: 4
Options:	0 = Local control; 1 = Fieldbus; 2 = Mixed interface; 4 = NET, local on fault; or 5 = Dual mode.			
Description:	PNU928 which specifies the control priority of the device for cyclic communication.			
P11.5.3	Fault situation counter			ID 2632
Minimum value:	N.A.	Maximum value:	N.A.	Default value: N.A.
Description:	PNU952 which specifies the fault situation counter. Only write of 0 is allowed, then the whole fault buffer (actual fault situation and all other fault situations) and the fault message counter (parameter 944) are erased.			
P11.5.4	Board status			ID 2609
Minimum value:	N.A.	Maximum value:	N.A.	Default value: 0
Description:	Status of the board. B0-DCOM communication fault. B1-Board HW fault B2-IO1 24 volt overload fault. B3-Profibus communication fault. B4-fieldbus fault.			
P11.5.5	Firmware version			ID 2610
Minimum value:	N.A.	Maximum value:	N.A.	Default value: N.A.
Description:	This parameter provides the firmware version of the SWD.			
P11.5.6	Protocol status			ID 2612
Minimum value:	N.A.	Maximum value:	N.A.	Default value: 0
Options:	0 = Not configured; 1 = Operational; or 2 = Diagnostics.			
Description:	This parameter specifies the protocol status for SWD card.			
P11.6 - Bluetooth.				
P11.6.1	Bluetooth enabled			ID 1895
Minimum value:	N.A.	Maximum value:	N.A.	Default value: 0
Options:	0 = Disabled; or 1 = Enabled.			
Description:	Bluetooth enabled.			

Table 17. Serial communication (Cont.).

P11.6.2^②	Bluetooth broadcast mode			ID 2920
Minimum value:	N.A.	Maximum value:	N.A.	Default value: 0
Options:	0 = Off; or 1 = On.			
Description:	Bluetooth broadcast mode.			
P11.6.3	Bluetooth pairing reset			ID 2935
Minimum value:	N.A.	Maximum value:	N.A.	Default value: N.A.
Options:	0 = Not reset; or 1 = Reset.			
Description:	Bluetooth pairing reset.			

① Parameter value can only be changed after the drive has stopped.

② Parameter value will be set to be default when changing macros.

Table 18. Ethernet communication .

P12.1 - Basic settings.				
P12.1.1^①	IP address mode			ID 1500
Minimum value:	N.A.	Maximum value:	N.A.	Default value: 0
Options:	0 = Static IP; or 1 = DHCP with AutoIP.			
Description:	This parameter defined the IP address configuration mode for EIP/modbus TCP.			
P12.1.2	Active IP address			ID 1507
Minimum value:	N.A.	Maximum value:	N.A.	Default value: N.A.
Description:	Reads the current active IP address.			
P12.1.3	Active subnet mask			ID 1509
Minimum value:	N.A.	Maximum value:	N.A.	Default value: N.A.
Description:	Reads the current active subnet mask.			
P12.1.4	Active default gateway			ID 1511
Minimum value:	N.A.	Maximum value:	N.A.	Default value: N.A.
Description:	Reads the current active default gateway.			
P12.1.5	MAC address			ID 1513
Minimum value:	N.A.	Maximum value:	N.A.	Default value: N.A.
Description:	Reads the current MAC address.			
P12.1.6^①	Static IP address			ID 1501
Minimum value:	N.A.	Maximum value:	N.A.	Default value: 192.168.1.254
Description:	Defines the static IP address.			
P12.1.7^①	Static subnet mask			ID 1503
Minimum value:	N.A.	Maximum value:	N.A.	Default value: 255.255.255.0
Description:	Defines the static subnet mask.			
P12.1.8^①	Static default gateway			ID 1505
Minimum value:	N.A.	Maximum value:	N.A.	Default value: 192.168.1.1
Description:	Defines the static default gateway.			
P12.1.9	Ethernet communication timeout			ID 611
Minimum value:	0 ms	Maximum value:	60,000 ms	Default value: 10,000 ms
Description:	Selects the time it waits before a communication fault occurs over ethernet.			

Table 18. Ethernet communication (Cont.).

P12.2 - Trusted IP filter (DM1 PRO only).					
P12.2.1	Trusted IP white list				ID 68
Minimum value:	N.A.	Maximum value:	N.A.	Default value:	0.0.0.0 0.0.0.0 192.168.1.255
Description:	Defines the IP addresses in the white list. A setting of 192.168.1.255 enables all connections on the local subnet.				
P12.2.2	Trusted IP filter enable				ID 76
Minimum value:	N.A.	Maximum value:	N.A.	Default value:	1
Options:	0 = Disabled; or 1 = Enabled.				
Description:	Enables IP white listing. Devices not in the white list will not be able to establish communications with the drive.				
P12.3 - Modbus TCP (DM1 PRO only).					
P12.3.1^①	Modbus TCP enable				ID 1942
Minimum value:	N.A.	Maximum value:	N.A.	Default value:	0
Options:	0 = Disable; or 1 = Enable.				
Description:	Enables modbus TCP communications, must be enabled to connect to Power Xpert inControl.				
P12.3.2	Modbus TCP connection limit				ID 609
Minimum value:	N.A.	Maximum value:	N.A.	Default value:	5
Description:	Maximum number of connections allowed to the drive.				
P12.3.3	Modbus TCP unit identifier number				ID 610
Minimum value:	N.A.	Maximum value:	N.A.	Default value:	1
Description:	Unit identifier unit value for modbus TCP.				
P12.3.4	Modbus TCP protocol status				ID 612
Minimum value:	N.A.	Maximum value:	N.A.	Default value:	N.A.
Options:	0 = Stopped; 1 = Operational; or 2 = Faulted.				
Description:	This parameter shows the protocol status for modbus TCP communication.				
P12.3.5	Modbus TCP fault response				ID 2517
Minimum value:	N.A.	Maximum value:	N.A.	Default value:	0
Options:	0 = Only in fieldbus control mode - when fieldbus is the control place and fieldbus fault is active, the drive will fault on loss of communications. If not in fieldbus control, place will not fault. 1 = In all control modes - no matter the control place setting, if communication is lost, fieldbus fault response will occur.				
Description:	Defines the fieldbus fault condition for modbus TCP communication.				
P12.4 - Ethernet IP (DM1 PRO only).					
P12.4.1^①	Ethernet based protocol select				ID 1997
Minimum value:	N.A.	Maximum value:	N.A.	Default value:	0
Options:	0 = Disabled; or 2 = BACnet IP.				
Description:	Selects the active communication protocol on the ethernet I/P port.				
P12.4.2	Ethernet IP protocol status				ID 608
Minimum value:	N.A.	Maximum value:	N.A.	Default value:	N.A.
Options:	0 = Off; 1 = Operational; or 2 = Faulted.				
Description:	Indicates if ethernet protocol is active or not.				

Table 18. Ethernet communication (Cont.)

P12.4.3	Ethernet IP fault response			ID 2518
Minimum value:	N.A.	Maximum value:	N.A.	Default value: 0
Options:	0 = Only in fieldbus control mode - when fieldbus is the control place and Fieldbus fault is active, the drive will fault on loss of communications. If not in fieldbus control, place will not fault. 1 = In all control modes - no matter the control place setting. If communication is lost, fieldbus fault response will occur.			
Description:	Defines the fieldbus fault condition for ethernet IP communication.			
P12.5 - BACnet IP (DM1 PRO only).				
P12.5.1^①	BACnet IP UDP port number			ID 1733
Minimum value:	N.A.	Maximum value:	N.A.	Default value: 47,808
Options:	47808 = BAC0; 47809 = BAC1; 47810 = BAC2; 47811 = BAC3; 47812 = BAC4; 47813 = BAC5; 47814 = BAC6; 47815 = BAC7; 47816 = BAC8; 47817 = BAC9; 47818 = BACA; 47819 = BACB; 47820 = BACC; 47821 = BACD; 47822 = BACE; or 47823 = BACF.			
Description:	Defines the BACnet UDP port number.			
P12.5.2^①	BACnet IP foreign device			ID 1734
Minimum value:	N.A.	Maximum value:	N.A.	Default value: 0
Options:	0 = Disabled; or 1 = Enabled.			
Description:	Enables BACNET IP foreign device configuration.			
P12.5.3^①	BACnet IP BBMD IP			ID 1735
Minimum value:	N.A.	Maximum value:	N.A.	Default value: 0.0.0.0
Description:	Displays the BACnet BBMD IP address.			
P12.5.4^①	BACnet IP UDP port			ID 1737
Minimum value:	N.A.	Maximum value:	N.A.	Default value: 47,808
Options:	47808 = BAC0; 47809 = BAC1; 47810 = BAC2; 47811 = BAC3; 47812 = BAC4; 47813 = BAC5; 47814 = BAC6; 47815 = BAC7; 47816 = BAC8; 47817 = BAC9; 47818 = BACA; 47819 = BACB; 47820 = BACC; 47821 = BACD; 47822 = BACE; or 47823 = BACF.			
Description:	Displays the BACnet BBMD UDP port number.			
P12.5.5^①	BACnet IP registration interval			ID 1738
Minimum value:	0	Maximum value:	65,535	Default value: 10
Description:	Defines the registration interval.			

Table 18. Ethernet communication (Cont.).

P12.5.6	BACnet IP communication timeout			ID 1739
Minimum value:	0	Maximum value:	60,000	Default value: 0
Description:	Selects the time it waits before a communication fault occurs over BACnet IP.			
P12.5.7	BACnet IP protocol status			ID 1740
Minimum value:	N.A.	Maximum value:	N.A.	Default value: 0
Options:	0 = Stopped; 1 = Operational; or 2 = Faulted.			
Description:	This parameter shows the protocol status for BACnet IP communication.			
P12.5.8	BACnet IP fault behavior			ID 1741
Minimum value:	N.A.	Maximum value:	N.A.	Default value: 0
Options:	0 = Only in fieldbus control mode - when fieldbus is the control place and Fieldbus fault is active, the drive will fault on loss of communications. If not in fieldbus control, place will not fault. 1 = In all control modes - no matter the control place setting. If communication is lost, fieldbus fault response will occur.			
Description:	Defines the fieldbus fault condition for BACnet IP communication.			
P12.5.9^①	BACnet IP instance number			ID 1742
Minimum value:	0	Maximum value:	4,194,302	Default value: 0
Description:	Displays the BACnet instance number.			
P12.6 - Web UI (DM1 PRO only).				
P12.6.1	Web UI protocol status			ID 2915
Minimum value:	N.A.	Maximum value:	N.A.	Default value: N.A.
Options:	0 = Off; 1 = Operational; or 2 = Faulted.			
Description:	This parameter shows the protocol status for web server communication.			
P12.6.2	Web UI fault response			ID 2916
Minimum value:	N.A.	Maximum value:	N.A.	Default value: 0
Options:	0 = Only in fieldbus control mode - when fieldbus is the control place and fieldbus fault is active, the drive will fault on loss of communications. If not in fieldbus control, place will not fault. 1 = In all control modes - no matter the control place setting. If communication is lost, fieldbus fault response will occur.			
Description:	Defines the fieldbus fault condition for web server communication.			
P12.6.3	Web UI communication timeout			ID 2919
Minimum value:	30,000 ms	Maximum value:	60,000 ms	Default value: 60,000 ms
Description:	Selects the time it waits before a communication fault occurs over the web server.			
P12.6.4^①	Web UI enable			ID 2921
Minimum value:	N.A.	Maximum value:	N.A.	Default value: 0
Options:	0 = Disabled; or 1 = Enabled.			
Description:	Enables web server configuration and monitoring page.			
P12.7.2	IOT connection status			ID 3001
Minimum value:	N.A.	Maximum value:	N.A.	Default value: 0
Options:	0 = Disconnected; or 1 = Connected.			
Description:	IOT connection status.			

Table 18. Ethernet communication (Cont.).

P12.7.3	Proxy enable				ID 3003
Minimum value:	N.A.	Maximum value:	N.A.	Default value:	1
Options:	0 = Disabled; or 1 = Enabled.				
Description:	Proxy enable.				

① Parameter value can only be changed after the drive has stopped.

Table 19. System.

P13.1 - Basic settings.					
P13.1.1	Language				ID 340
Minimum value:	N.A.	Maximum value:	N.A.	Default value:	0
Options:	0 = English; 1 = English; or 2 = English.				
Description:	This parameter offers the ability to control the frequency converter through the keypad in the language of your choice. Currently available language is English only.				
P13.1.2 ①	Application				ID 142
Minimum value:	N.A.	Maximum value:	N.A.	Default value:	N.A.
Options:	0 = Standard; 1 = Pump; 2 = Fan; or 3 = Multi-purpose.				
Description:	This parameter sets the active application if multiple applications have been loaded.				
P13.1.3 ①	Parameter sets				ID 619
Minimum value:	N.A.	Maximum value:	N.A.	Default value:	N.A.
Options:	0 = No; 1 = Reload defaults; 2 = Reload set 1; 3 = Reload set 2; 4 = Store set 1; 5 = Store set 2; 6 = Reset; or 7 = Reload defaults VM.				
Description:	This parameter allows you to reload the factory default parameter values, and to store and load two customized parameter sets.				
P13.1.4	Up to keypad				ID 620
Minimum value:	N.A.	Maximum value:	N.A.	Default value:	N.A.
Options:	0 = No; or 1 = Yes (all parameters).				
Description:	This function uploads all existing parameter groups to the keypad.				
P13.1.5 ①	Down from keypad				ID 621
Minimum value:	N.A.	Maximum value:	N.A.	Default value:	N.A.
Options:	0 = No; 1 = All parameters; 2 = All, no motor; or 3 = Application parameters.				
Description:	This function downloads one or all parameter groups from the keypad to the drive.				

Table 19. System (Cont.).

P13.1.7	Parameter lock PIN			ID 624
Minimum value:	0	Maximum value:	9,999	Default value: 0
Description:	<p>The application selection can be protected against unauthorized changes with the password function. When the password function is enabled, the user will be prompted to enter a password before application changes, parameter value changes, or password changes.</p> <p>By default, the password function is not in use. If you want to activate the password, change the value of this parameter to any number between 1 and 9,999.</p> <p>To deactivate the password, reset the parameter value to 0.</p>			
P13.1.8	Keypad parameter lock			ID 625
Minimum value:	N.A.	Maximum value:	N.A.	Default value: 0
Options:	0 = Change enable; or 1 = Change disable.			
Description:	<p>This function allows the user to prohibit changes to the parameters. If the parameter lock is activated, the text "locked" will appear on the display if you try to edit a parameter value.</p> <p>Note: This function does not prevent unauthorized editing of parameter values.</p>			
P13.1.9	Start-up Wizard			ID 626
Minimum value:	N.A.	Maximum value:	N.A.	Default value: 0
Options:	0 = Enabled. 1 = Disabled.			
Description:	<p>The Start-up Wizard facilitates commissioning the DM1 PRO. If selected "Enable", the Start-up Wizard prompts the operator for the application desired and then advances parameters through the start-up parameter list/Application Mini wizard in keypad. After completion, it allows the user to go to the main menu or default page and this parameter is set to "Disabled". The Start-up Wizard is always enabled for the initial power up of the DM1 PRO. By setting this parameter to "Disable" without going through the Start-up Wizard, it will not cause it to be active on start-up. If user goes into Start-up Wizard after completion, or defaults drive, the Start-up Wizard will be "Enabled".</p>			
P13.2 - Keypad.				
P13.2.4	Timeout time			ID 629
Minimum value:	1 s	Maximum value:	65,535 s.	Default value: 30 s
Description:	<p>The timeout time setting defines the time after which the keypad display returns to the Default Page.</p> <p>Note: If the default page value is 0, the timeout time setting has no effect.</p>			
P13.2.5	Contrast adjust			ID 630
Minimum value:	5	Maximum value:	18	Default value: 12
Description:	If the remote keypad display is not clear, you can adjust the keypad contrast with this parameter.			
P13.2.6	Backlight time			ID 631
Minimum value:	1 min.	Maximum value:	65,535 min.	Default value: 10 min.
Description:	This parameter determines how long the backlight stays on before going out.			
P13.2.7	Fan control			ID 632
Minimum value:	N.A.	Maximum value:	N.A.	Default value: 2
Options:	<p>0 = Continuous - fan runs continuously.</p> <p>1 = Temperature - based on the temperature of the unit. The fan is switched on automatically when the heat sink temperature reaches 60°C (140°F). The fan receives a stop command when the heat sink temperature falls to 55°C (131°F). The fan runs for about a minute after receiving the stop command or switching on the power, as well as after changing the value from "Continuous" to "Temperature".</p> <p>2 = Run follow - after power up, the fan is stopped until the run command is given and then fan runs continuously. This is mainly made for common DC-bus systems to prevent cooling fans to load charging resistors on power up moment.</p>			
Description:	This function allows you to control the DM1 PRO's cooling fan.			

Table 19. System (Cont.).

P13.4 - Version information.					
P13.4.1	Keypad software version				ID 640
Minimum value:	N.A.	Maximum value:	N.A.	Default value:	N.A.
Description:	Keypad firmware version.				
P13.4.2	Motor control software version				ID 642
Minimum value:	N.A.	Maximum value:	N.A.	Default value:	N.A.
Description:	DSP/motor control software version.				
P13.4.3	Application software version				ID 644
Minimum value:	N.A.	Maximum value:	N.A.	Default value:	N.A.
Description:	MCU/application software version.				
P13.4.4	Software bundle version				ID 1714
Minimum value:	N.A.	Maximum value:	N.A.	Default value:	N.A.
Description:	Software bundle version.				
P13.5 - Application information.					
P13.5.1	Serial number				ID 648
Minimum value:	N.A.	Maximum value:	N.A.	Default value:	N.A.
Description:	Product serial number.				
P13.5.2	Multi-monitor set				ID 627
Minimum value:	N.A.	Maximum value:	N.A.	Default value:	0
Options:	0 = Change enable; or 1 = Change disable.				
Description:	The keypad display can display three actual monitored values at the same time. This parameter determines if the operator is allowed to replace the values monitored with other values.				
P13.5.3	Keypad lock PIN				ID 75
Minimum value:	0	Maximum value:	9,999	Default value:	0
Description:	<p>The keypad can be protected against unauthorized changes with the keypad lock function after keys are not pressed five minutes. When the password function is enabled, the user will be prompted to enter a password before the keypad display parameter or response to key press except up/down/left/right.</p> <p>By default, the password function is not in use. If you want to activate the password, change the value of this parameter to any number between 1 and 9,999.</p> <p>To deactivate the password, reset the parameter value to 0.</p>				
P13.5.4	Drive application name				ID 2922
Minimum value:	N.A.	Maximum value:	N.A.	Default value:	N.A.

① Parameter value can only be changed after the drive has stopped.

Chapter 5 - Fan control application

Introduction

The fan application builds on the features included in standard. In addition to all of the features in the standard application, the fan application provides features specific for HVAC applications and fan related protective features.

Fan application includes functions:

- Damper control;
- Fire mode;
- Smoke purge; and
- Broken belt protection.

I/O controls

“Function to terminal” (FTT) programming

The design behind programming of the digital inputs and outs of the DM1 uses “function to terminal” programming. It is composed of a terminal, be it a relay output or a digital output, that is assigned a parameter. Within that parameter, it has different functions that can be set.

Chapter 5 - Fan control application

Control I/O configuration

- Run 240 Vac and 24 Vdc control wiring in separate conduit.
- Communication wire to be shielded.

Table 20. Fan application default I/O connection.

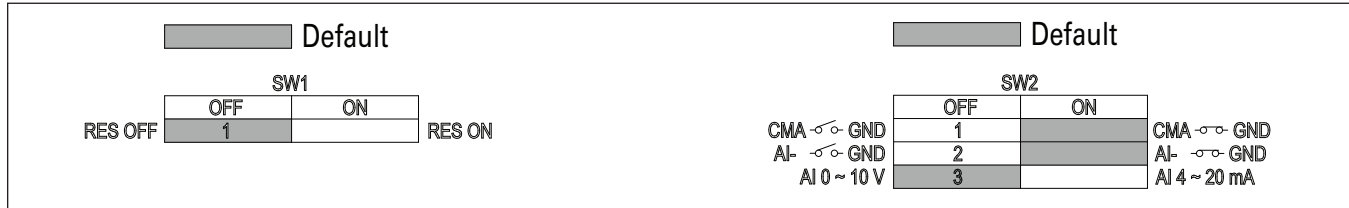

External wiring	Terminal	Short name	Name	Default setting	Description
	1	DI1	Digital input 1	Run forward	Starts the motor in the forward direction.
	2	DI2	Digital input 2	Run reverse	Start the motor in the reverse direction.
	3	DI3	Digital input 3	External fault	Triggers a fault in the drive.
	4	DI4	Digital input 4	Fault reset	Resets active faults in the drive.
	5	CMA	DI1 to DI4 common	Grounded	Allows for sourced input.
	6	A	RS-485 signal A	—	Fieldbus communication (Modbus RTU, BACNet).
	7	B	RS-485 signal B	—	Fieldbus communication (Modbus RTU, BACNet).
	8	AI1+ [Ⓢ]	Analog input 1	0 - 10 V	Voltage speed reference (programmable to 4 mA to 20 mA).
	9	AI1-	Analog input 1 ground	—	Analog input 1 common (ground).
	10	GND	I/O signal ground	—	I/O ground for reference and control.
	11	AO1+	Analog output 1	Output frequency	Shows output frequency to motor 0 - 60 Hz (4 mA to 20 mA).
	12	GND	I/O signal ground	—	I/O ground for reference and control.
	13	10 V	10 Vdc reference output	10.3 Vdc +/- 3%	10 Vdc reference voltage.
	14	24 V	24 Vdc control output	24 Vdc In/Out	Control voltage input/output (100 mA max.).
	15	STO_com	Safe torque common	—	Safe torque Off common.
	16	STO2	Safe torque Off 2	—	Safe torque Off 2 input.
	17	STO1	Safe torque Off 1	—	Safe torque Off 1 input.
	18	R1NO	Relay 1 normally open	Run	Changes state when the drive is in the run state.
	19	R1CM	Relay 1 common		
	20	R1NC	Relay 1 normally closed		
	21	R2NO	Relay 2 normally open	Fault	Changes state when the drive is in the fault state.
	22	R2CM	Relay 2 common		

Notes:

The above wiring demonstrates a SINK configuration. It is important that CMA is wired to ground (as shown by dashed line). If a SOURCE configuration is desired, wire 24 V to CMA and close the inputs to ground. When using the +10 V for AI1, it is important to wire AI1- to ground (as shown by dashed line). If using +10 V for AI1, terminals 9 and 10 need to be jumpered together.

Ⓢ AI1+ support 10 K potentiometer.

Fan application - parameters list

On the next pages you will find the lists of parameters within the respective parameter groups. Each parameter section within the table lists:

- Parameter code (location indication on the keypad; shows the operator the present parameter number);
- Parameter name;
- ID (number of the parameter);

and where applicable:

- Minimum value and units;
- Maximum value and units;
- Default value and units;
- Options (when available); and
- Description of the parameter.

Table 21. Monitor .

M1 - standard.				
M1.1	Output frequency			ID 1
Minimum value:	Hz	Maximum value:	Hz	Default value: Hz
Description:	Output frequency (Hz).			
M1.2	Frequency reference			ID 24
Minimum value:	Hz	Maximum value:	Hz	Default value: Hz
Description:	Reference frequency (Hz).			
M1.3	Motor speed			ID 2
Minimum value:	rpm	Maximum value:	rpm	Default value: rpm
Description:	Motor output speed (rpm).			
M1.4	Motor current			ID 3
Minimum value:	A	Maximum value:	A	Default value: A
Description:	Motor output current RMS (Amps).			
M1.5	Motor torque			ID 4
Minimum value:	%	Maximum value:	%	Default value: %
Description:	Percent motor torque calculated from nameplate values and measured motor current (%).			
M1.6	Motor power			ID 5
Minimum value:	%	Maximum value:	%	Default value: %
Description:	Percent motor power calculated from nameplate values and measured motor current (%).			
M1.7	Motor voltage			ID 6
Minimum value:	V	Maximum value:	V	Default value: V
Description:	Output ac motor voltage (Vac).			
M1.8	DC-link voltage			ID 7
Minimum value:	V	Maximum value:	V	Default value: V
Description:	DC bus voltage (Vdc).			

Table 21. Monitor (Cont.).

M1 - standard (Cont.).				
M1.9	Unit temperature			ID 8
Minimum value:	°C	Maximum value:	°C	Default value: °C
Description:	Heat sink temperature (deg. C).			
M1.10	Motor temperature			ID 9
Minimum value:	%	Maximum value:	%	Default value: %
Description:	Motor temperature value calculated from nameplate values and measured motor current (%).			
M1.11	Latest fault code			ID 28
Minimum value:	N.A.	Maximum value:	N.A.	Default value: N.A.
Description:	Last active fault code value. See fault codes for the value shown here.			
M1.12	Instant motor power			ID 1686
Minimum value:	kW	Maximum value:	kW	Default value: kW
Description:	Instantaneous motor power (kW).			
M2 - I/O status.				
M2.1	Analog input 1			ID 10
Minimum value:	Varies	Maximum value:	Varies	Default value: Varies
Description:	Analog input 1 measured value (Vdc or Amps) selectable with dipswitch.			
M2.2	Keypad pot voltage			ID 1858
Minimum value:	V	Maximum value:	V	Default value: V
Description:	Keypad potentiometer measured value (Vdc). DM1 PRO only.			
M2.3	Analog output			ID 25
Minimum value:	Varies	Maximum value:	Varies	Default value: Varies
Description:	Analog output 1 measured value (Vdc or Amps) selectable with parameter.			
M2.4	DI1, DI2, DI3			ID 12
Minimum value:	N.A.	Maximum value:	N.A.	Default value: N.A.
Description:	Digital input 1/2/3 status.			
M2.5	DI4			ID 13
Minimum value:	N.A.	Maximum value:	N.A.	Default value: N.A.
Description:	Digital input 4 status.			
M2.8	RO1, RO2			ID 557
Minimum value:	N.A.	Maximum value:	N.A.	Default value: N.A.
Description:	Relay output 1 and 2 status.			
M5 - PI monitor.				
M5.1	PI setpoint			ID 16
Minimum value:	Varies	Maximum value:	Varies	Default value: Varies
Description:	PI setpoint in process units.			
M5.2	PI feedback			ID 18
Minimum value:	Varies	Maximum value:	Varies	Default value: Varies
Description:	PI feedback level in process units.			
M5.3	PI error value			ID 20
Minimum value:	Varies	Maximum value:	Varies	Default value: Varies
Description:	PI error in process units.			

Table 21. Monitor (Cont.).

M5.4	PI output			ID 22
Minimum value:	%	Maximum value:	%	Default value: %
Description:	PI output.			
M5.5	PI status			ID 23
Minimum value:	N.A.	Maximum value:	N.A.	Default value: N.A.
Options:	0 = Stopped; 1 = Running; or 2 = Sleep mode.			
Description:	PI status indication, indicates if drive is stopped, running in PI mode, or in PI sleep mode.			
M9 - Multi-monitoring.				
M9.1	Multi-monitoring			ID 30
Minimum value:	N.A.	Maximum value:	N.A.	Default value: 0, 1, 2.
Description:	Displays any three monitoring values in a single screen. The values are selectable via the keypad menu. Multi-monitor page could see three lines of monitoring values. Up and down keys can be used to select the row and then hitting the left arrow key will allow for editing the value then by going up and down.			

Table 22. Parameters .

P1 - Basic parameters.				
P1.1²	Minimum frequency			ID 101
Minimum value:	0.00 Hz	Maximum value:	400.00 Hz	Default value: 0.00 Hz
Description:	Defines the lowest frequency at which the drive will operate. This setting will limit other frequency parameter settings. 1 = Fire mode minimum frequency. 2 = Derag. 3 = MPFC staging frequency. 4 = MPFC master fixed frequency. 5 = Prime pump frequency. 6 = Prime pump frequency 2.			
P1.2²	Maximum frequency			ID 102
Minimum value:	0.00 Hz	Maximum value:	400.00 Hz	Default value: MaxFreqMFG
Description:	Defines the highest frequency at which the drive will operate. This will limit other frequency parameters. 1 = Keypad reference. 3 = Motor potentiometer. 3 = Jog speed. 4 = 2nd stage ramp frequency. 5 = Fire mode minimum frequency. 6 = Derag. 7 = MPFC staging frequency. 8 = MPFC master fixed frequency. 9 = Prime pump frequency. 10 = Prime pump frequency 2. 11 = Preset speed frequency. 12 = Frequency limit value. 13 = Reference limit value. 14 = Speed control_fs2. 15 = Stall frequency limit. 16 = 4 mA fault frequency. 17 = MPFC de-staging frequency. 18 = Pipe fill loss frequency low. 19 = Pipe fill loss frequency high. 20 = Broken pipe frequency limit.			
P1.3²	Accel. time 1			ID 103
Minimum value:	0.1 s	Maximum value:	3,000.0 s	Default value: 20.0 s
Description:	Defines the time required for the output frequency to accelerate from zero frequency to maximum frequency.			

Chapter 5 - Fan control application

Table 22. Parameters (Cont.)

P1.4^②	<i>Decel. time 1</i>			ID 104
Minimum value:	0.1 s	Maximum value:	3,000.0 s	Default value: 20.0 s
Description:	Defines the time required for the output frequency to decelerate from maximum frequency to zero frequency.			
P1.6^①	<i>Motor nom. current</i>			ID 486
Minimum value:	DriveNomCurrCT*1/10 A	Maximum value:	DriveNomCurrCT*2 A	Default value: DriveNomCurrCT A
Description:	Motor nameplate rated full load current. This value is found on the rating plate of the motor.			
P1.7^①	<i>Motor nom. speed</i>			ID 489
Minimum value:	300 rpm	Maximum value:	20,000 rpm	Default value: MotorNomSpeedMFG
Description:	Motor nameplate rated speed. This value is found on the rating plate of the motor.			
P1.8^①	<i>Motor PF</i>			ID 490
Minimum value:	0.30	Maximum value:	1.00	Default value: 0.85
Description:	Motor nameplate rated power factor. This value is found on the rating plate of the motor.			
P1.9^①	<i>Motor nom. voltage</i>			ID 487
Minimum value:	180 V	Maximum value:	690 V	Default value: MotorNomVoltMFG V
Description:	Motor nameplate rated voltage. This value is found on the rating plate of the motor.			
P1.10^①	<i>Motor nom. frequency</i>			ID 488
Minimum value:	8.00 Hz	Maximum value:	400.00 Hz	Default value: MotorNomFreqMFG Hz
Description:	Motor nameplate rated frequency. This value is found on the rating plate of the motor.			
P1.11^②	<i>Local control place</i>			ID 1695
Minimum value:	N.A.	Maximum value:	N.A.	Default value: 0
Options:	0 = keypad; 1 = I/O terminal; or 3 = fieldbus.			
Description:	Defines the signal location for the start command in local mode. I/O terminals would be from the digital hard-wired inputs or keypad for Start/Stop buttons on the drive. Keypad display will indicate which mode is selected.			
P1.12^{①②}	<i>Local reference</i>			ID 136
Minimum value:	N.A.	Maximum value:	N.A.	Default value: 1
Options:	0 = AI; 1 = drive ref. pot; 4 = maximum frequency; 6 = keypad; or 7 = fieldbus ref.			
Description:	Defines the signal location for the speed reference in local mode.			
P1.13^②	<i>Remote control place</i>			ID 135
Minimum value:	N.A.	Maximum value:	N.A.	Default value: 0
Options:	0 = I/O terminal; 1 = fieldbus; or 3 = keypad.			
Description:	Defines the signal location for the start command in remote mode. I/O terminals would be from the digital hard-wired inputs or keypad for Start/Stop buttons on the drive. Keypad display will indicate which mode is selected.			
P1.14^{①②}	<i>Remote reference</i>			ID 137
Minimum value:	N.A.	Maximum value:	N.A.	Default value: 0
Options:	0 = AI; 1 = drive reference pot; 4 = maximum frequency; 6 = keypad; or 7 = fieldbus reference.			
Description:	Defines the signal location for the speed reference in remote mode.			

Table 23. Inputs .

P2.1 - Basic settings.				
P2.1.1 ^②	AI reference scale minimum value			ID 144
Minimum value:	0.00 Hz	Maximum value:	RefScaleMax Hz	Default value: 0.00 Hz
Description:	Defines the minimum frequency associated with 0% input from the analog input. Setting AI reference scale minimum value and AI reference scale maximum value both to zero will cause the analog input to scale to the minimum and maximum frequencies.			
P2.1.2 ^②	AI reference scale maximim value			ID 145
Minimum value:	RefScaleMin Hz	Maximum value:	400.00 Hz	Default value: 0.00 Hz
Description:	Defines the maximum frequency associated with 100% input from the analog input. Setting AI reference scale minimum value and AI reference scale maximum value both to zero will cause the analog input to scale to the minimum and maximum frequencies.			
P2.1.3 ^{①②}	IO terminal Start/Stop logic			ID 143
Minimum value:	N.A.	Maximum value:	N.A.	Default value: 0
Options:	0 = Forward - reverse: maintained input on start signal 1 to run forward and a maintained signal on start signal 2 for reverse. 1 = Start - reverse: maintained input on start signal 1 to run forward and a maintained signal on start signal 2 for reverse. 2 = Start - enable: maintained input on start signal 1 to run forward and a maintained signal on start signal 2 to enable the drive to run. 3 = Start pulse - stop pulse: used for three-wire operation, start signal 1 uses a normally open start and start signal 2 uses a normally closed stop.			
Description:	Defines the functionality for start signal 1 and start signal 2. By default, start signal 1 is DI1 and start signal 2 is DI2. 0 = P3.2: IO terminal start signal 1 = start forward - P3.3: IO terminal start signal 2 = start reverse. This would be considered 2-wire control with either a contact used on the start FWD or start REV commands. When contacts open, the motor stops.			

Table 23. Inputs (Cont.).

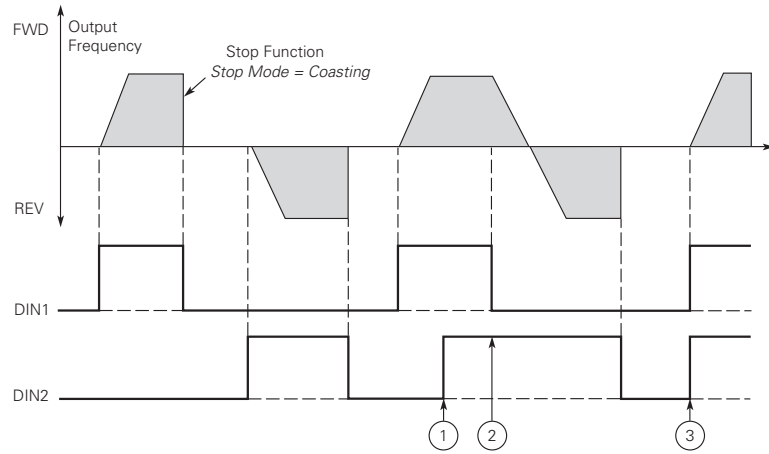

- Notes:**
- ① The first selected direction has the highest priority.
 - ② When the DIN1 contact opens the direction of rotation starts to change.
 - ③ If start forward (DIN1) and start reverse (DIN2) signals are active simultaneously the start forward signal (DIN1) has priority.

1 = P3.2: IO terminal start signal 1 = start forward - P3.3: IO terminal start signal 2 = start reverse. This would be considered 2-wire control with a contact on start/stop, contact open it stops and direction on 2nd start signal.

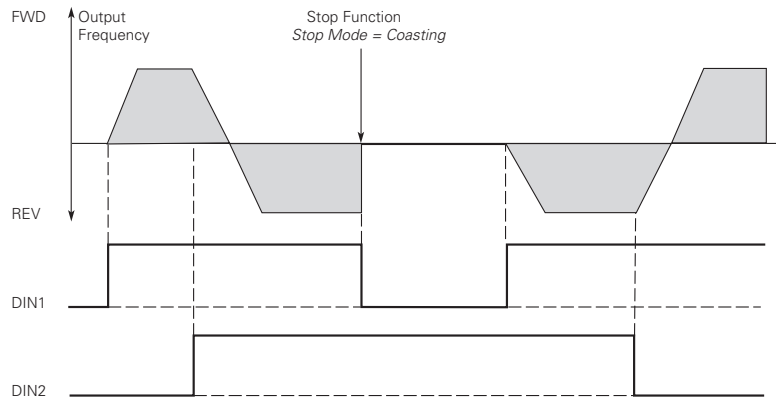
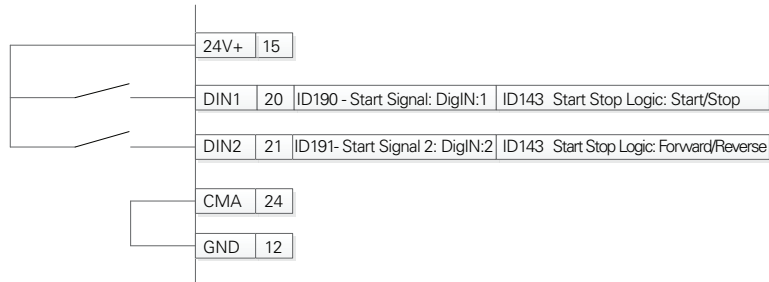
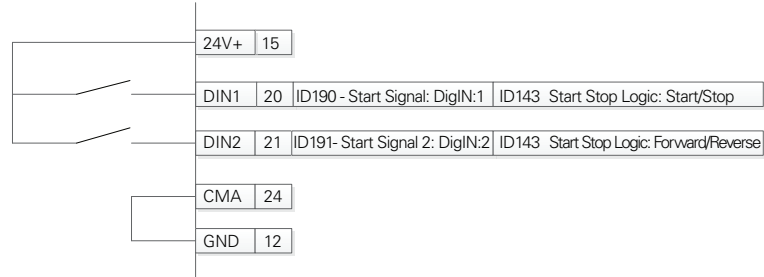

Table 23. Inputs (Cont.).

2 = P3.2: DI closed contact = start/open contact = stop P3.3: IO terminal start signal 1 = start forward - P3.3: IO terminal start signal 2 = start reverse. This would be considered 3-wire control with start signal 2 required to be closed to enable start on start signal 1.



3 = Three-wire connection (pulse control): P3.2: IO terminal start signal 1 = start forward - P3.3: IO terminal start signal 2 = start reverse. This would be considered 3-wire control with start signal 1 being the start pulse and start signal 2 being the NC stop.

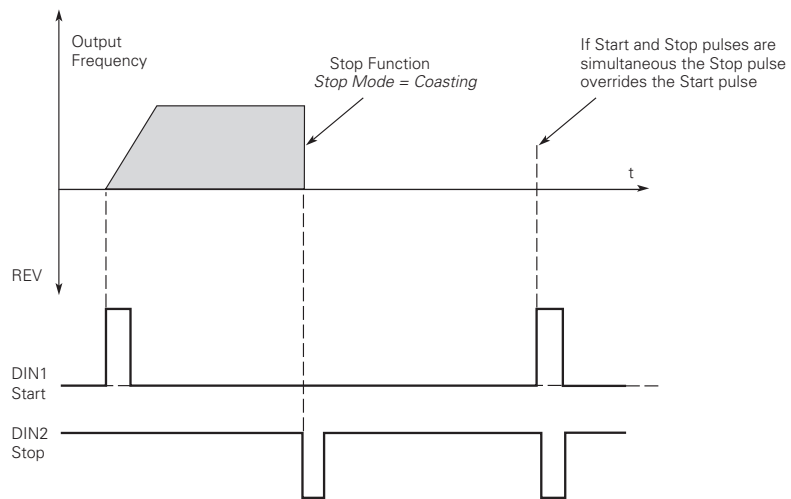
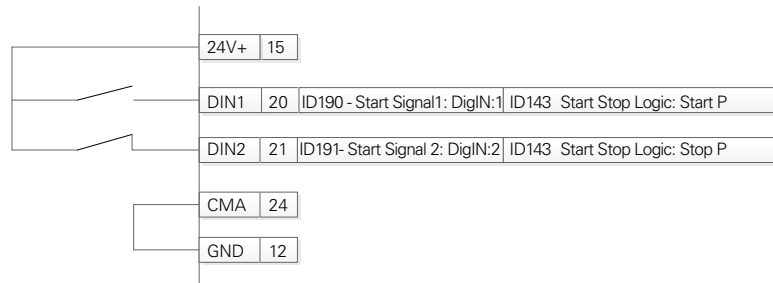

Table 23. Inputs (Cont.).

P2.2 - Digital input.					
P2.2.1[Ⓢ]	DI1 function				ID 1801
Minimum value:	N.A.	Maximum value:	N.A.	Default value:	1
Options:	0 = Not used, no action. 1 = IO terminal start signal 1, when the control source is set to IO terminal, this input when closed will perform the action defined by P2.1.3. 2 = IO terminal start signal 2, when the control source is set to IO terminal, this input when closed will perform the action defined by P2.1.3. 3 = Reverse, when Start/Stop logic is set to 3 start pulse stop pulse, this input will cause the drive to start in the reverse direction. 4 = Ext. fault 1, when closed, Ext. fault 1 will be activated. 5 = Ext. fault 2, when closed, Ext. fault 2 will be activated. 6 = Ext. fault 3, when closed, Ext. fault 3 will be activated. 7 = Fault reset, when closed all active faults will be reset. 8 = Run enable, when closed, the drive will allow a start command and be in the ready state. 9 = Preset speed B0, the seven preset speeds are selected via three binary inputs. This is least significant bit in that binary input. 10 = Preset speed B1, the seven preset speeds are selected via three binary inputs. 11 = Preset speed B2, the seven preset speeds are selected via three binary inputs. This is most significant bit in that binary input. 12 = Jog enable, when closed, the jog speed defined at P2.3.8 will override the frequency reference. 13 = Accel. pot value, when closed, the motor potentiometer value will increment at the rate defined by motor pot ramp time. 14 = Decel. pot value, when closed, the motor potentiometer value will decrement at the rate defined by motor pot ramp time. 15 = Reset pot zero, when closed, the motor potentiometer value will reset to zero. 16 = Accel./Decel. time set, when open, Accel./Decel. time 1 will be used. When closed, Accel./Decel. time 2 will be used. 17 = Accel./Decel. prohibit, when closed, the drive will hold the output frequency and ignore changes to the reference value. 18 = No access to param., when closed, no changes can be made to any setting in the drive. 19 = Remote control, when closed, the drive will be forced to the remote control place. 20 = Local control, when closed, the drive will be forced to the local control place. 21 = Parameter 1/2 Sel., when open, parameter set 1 is active. When closed, parameter set 2 is active. 22 = PI controller, when closed, the drive will force the reference source to PI controller output. 23 = PI setpoint select, when open, parameter setpoint 1 is active. When closed setpoint 2 is active. 24 = Motor interlock 1, when closed, motor will be enabled to run. 25 = Smoke mode, when closed, smoke mode will be active. 26 = Fire mode, when closed, the fire mode will be active. 27 = Fire mode Ref. 1/2 select, when fire mode is active and this input is open, fire mode Ref. 1 will be active. When closed, fire mode Ref. 2 will be active. 28 = Fire mode reverse, when fire mode is active and this input is open, the direction will be forward. When closed, the direction will be reverse. 29 = DC brake active, when closed, DC injection braking will be active. 30 = Preheat active, when closed, the preheat mode will be active. 31 = Derag. enable, when closed, the Derag. cycle for pumps will be initiated.				
Description:	Defines the function of digital input 1.				

Table 23. Inputs (Cont.).

P2.2.3^②	D12 function				ID 1803
Minimum value:	N.A.	Maximum value:	N.A.	Default value:	2
Options:	0 = Not used, no action. 1 = IO terminal start signal 1, when the control source is set to IO terminal, this input when closed will perform the action defined by P2.1.3. 2 = IO terminal start signal 2, when the control source is set to IO terminal, this input when closed will perform the action defined by P2.1.3. 3 = Reverse, when Start/Stop logic is set to three start pulse stop pulse, this input will cause the drive to start in the reverse direction. 4 = Ext. fault 1, when closed, Ext. fault 1 will be activated. 5 = Ext. fault 2, when closed, Ext. fault 2 will be activated. 6 = Ext. fault 3, when closed, Ext. fault 3 will be activated. 7 = Fault reset, when closed, all active faults will be reset. 8 = Run enable, when closed, the drive will allow a start command and be in the ready state. 9 = Preset speed B0, the seven preset speeds are selected via three binary inputs. This is least significant bit in that binary input. 10 = Preset speed B1, the seven preset speeds are selected via three binary inputs. 11 = Preset speed B2, the seven preset speeds are selected via three binary inputs. This is most significant bit in that binary input. 12 = Jog enable, when closed, the jog speed defined at P2.3.8 will override the frequency reference. 13 = Accel. pot value, when closed, the motor potentiometer value will increment at the rate defined by motor pot ramp time. 14 = Decel. pot value, when closed, the motor potentiometer value will decrement at the rate defined by motor pot ramp time. 15 = Reset pot zero, when closed, the motor potentiometer value will reset to zero. 16 = Accel./decel. time set, when open, accel./decel. time 1 will be used. When closed, accel./decel. time 2 will be used. 17 = Accel./decel. prohibit, when closed, the drive will hold the output frequency and ignore changes to the reference value. 18 = No access to param., when closed, no changes can be made to any setting in the drive. 19 = Remote control, when closed, the drive will be forced to the remote control place. 20 = Local control, when closed, the drive will be forced to the local control place. 21 = Parameter 1/2 Sel., when open, parameter set 1 is active. When closed, Parameter set 2 is active. 22 = PI controller, when closed, the drive will force the reference source to PI controller output. 23 = PI setpoint select, when open, parameter setpoint 1 is active. When closed, setpoint 2 is active. 24 = Motor interlock 1, when closed, the motor will be enabled to run. 25 = Smoke mode, when closed, smoke mode will be active. 26 = Fire mode, when closed, fire mode will be active. 27 = Fire mode Ref. 1/2 Sel., when fire mode is active and this input is open, fire mode Ref. 1 will be active. When closed, fire mode Ref. 2 will be active. 28 = Fire mode reverse, when fire mode is active and this input is open, the direction will be forward. When closed, the direction will be reverse. 29 = DC brake active, when closed, DC injection braking will be active. 30 = Preheat active, when closed, preheat mode will be active. 31 = Derag. enable, when closed, the Derag. cycle for pumps will be initiated.				
Description:	Defines the function of digital input 2.				
P2.2.5^②	D13 function				ID 1805
Minimum value:	N.A.	Maximum value:	N.A.	Default value:	4
Options:	0 = Not used, no action. 1 = IO terminal start signal 1 - when the control source is set to IO terminal, this input when closed will perform the action defined by P2.1.3. 2 = IO terminal start signal 2 - when the control source is set to IO terminal, this input when closed will perform the action defined by P2.1.3. 3 = Reverse - when Start/Stop logic is set to 3 start pulse stop pulse, this input will cause the drive to start in the reverse direction. 4 = Ext. fault 1 - when closed, ext. fault 1 will be activated. 7 = Fault reset - when closed, all active faults will be reset. 8 = Run enable - when closed the drive will allow a start command and be in the ready state. 9 = Preset speed B0 - the seven preset speeds are selected via three binary inputs, this is least significant bit in that binary input. 10 = Preset speed B1 - the seven preset speeds are selected via three binary inputs. 11 = Preset speed B2 - the seven preset speeds are selected via three binary inputs, this is most significant bit in that binary input. 16 = Accel./decel. time set - when open, accel./decel. time 1 will be used, when closed accel./decel. time 2 will be used. 19 = Remote control - when closed, the drive will be forced to the remote control place. 20 = Local control - when closed, the drive will be forced to the local control place. 22 = PI controller - when closed, the drive will force the reference source to PI controller output. 23 = PI setpoint select - when open, parameter setpoint 1 is active, when closed, setpoint 2 is active. 24 = Motor interlock 1 - when closed, motor will be enabled to run. 29 = DC brake active - when closed, DC injection braking will be active. 31 = Derag. enable - when closed. The Derag. cycle for pumps will be initiated.				
Description:	Defines the function of digital input 3.				

Chapter 5 - Fan control application

Table 23. Inputs (Cont.).

P2.2.7[Ⓢ]	D14 function			ID 1807
Minimum value:	N.A.	Maximum value:	N.A.	Default value: 7
Options:	0 = Not Used, no action; 1 = IO terminal start signal 1 - when the control source is set to IO terminal this input when closed will perform the action defined by P2.1.3; 2 = IO terminal start signal 2 - when the control source is set to IO terminal this input when closed will perform the action defined by P2.1.3; 3 = Reverse - when start/stop logic is set to 3 start pulse stop pulse, this input will cause the drive to start in the reverse direction; 4 = Ext. fault 1 - when closed, ext. fault 1 will be activated; 5 = Ext. fault 2 - when closed, ext. fault 2 will be activated; 6 = Ext. fault 3 - when closed, ext. fault 3 will be activated; 7 = Fault reset - when closed, all active faults will be reset; 8 = Run enable - when closed, the drive will allow a start command and be in the ready state; 9 = Preset speed B0 - the 7 preset speeds are selected via 3 binary inputs, this is least significant bit in that binary input; 10 = Preset speed B1 - the 7 preset speeds are selected via 3 binary inputs; 11 = Preset speed B2 - the 7 preset speeds are selected via 3 binary inputs, this is most significant bit in that binary input; 12 = Jog enable - when closed, the jog speed defined at P2.3.8 will override the frequency reference; 13 = Accel. pot value - when closed, the motor potentiometer value will increment at the rate defined by motor pot ramp time; 14 = Decel. pot value - when closed, the motor potentiometer value will decrement at the rate defined by motor pot ramp time; 15 = Reset pot zero - when closed, the motor potentiometer value will reset to zero; 16 = Accel./decel. time set - when open, accel./decel. time 1 will be used ; when closed accel./decel. time 2 will be used; 17 = Accel./decel. prohibit - when closed, the drive will hold the output frequency and ignore changes to the reference value; 18 = No access to parameters - when closed, no changes can be made to any setting in the drive; 19 = Remote control - when closed, the drive will be forced to the remote control place; 20 = Local control - when closed, the drive will be forced to the Local control place; 21 = Parameter 1/2 sel. - when open, parameter set 1 is active: when closed parameter set 2 is active; 22 = PI controller - when closed, the drive will force the reference source to PI controller output; 23 = PI set point select - when open, parameter set point 1 is active: when closed, set point 2 is active; 24 = Motor interlock 1 - when closed, motor will be enabled to run; 25 = Smoke mode - when closed, smoke mode will be active; 26 = Fire mode - when closed, fire mode will be active; 27 = Fire mode reference 1/2 sel. - when fire mode is active and this input is open, fire mode reference 1 will be active: when closed, fire mode reference 2 will be active; 28 = Fire mode reverse - when fire mode is active and this input is open, direction will be forward: when closed, reverse; 29 = DC brake active - when closed, DC injection braking will be active; 30 = Preheat active - when closed, preheat mode will be active; or 31 = Derag. enable - when closed, the Derag. cycle for pumps will be initiated.			
Description:	Defines the function of digital input 4.			
P2.3 - Preset speed.	Preset speed 1			105
P2.3.1[Ⓢ]	Preset speed 1			ID 105
Minimum value:	0.00 Hz	Maximum value:	MaxFreq Hz	Default value: 5.00 Hz
Description:	Preset speed is selected with digital inputs using a binary input.			
P2.3.2[Ⓢ]	Preset speed 2			ID 106
Minimum value:	0.00 Hz	Maximum value:	MaxFreq Hz	Default value: 5.00 Hz
Description:	Preset speed is selected with digital inputs using a binary input.			
P2.3.3[Ⓢ]	Preset speed 3			ID 118
Minimum value:	0.00 Hz	Maximum value:	MaxFreq Hz	Default value: 15.00 Hz
Description:	Preset speed is selected with digital inputs using a binary input.			
P2.3.4[Ⓢ]	Preset speed 4			ID 119
Minimum value:	0.00 Hz	Maximum value:	MaxFreq Hz	Default value: 20.00 Hz
Description:	Preset speed is selected with digital inputs using a binary input.			
P2.3.5[Ⓢ]	Preset speed 5			ID 120
Minimum value:	0.00 Hz	Maximum value:	MaxFreq Hz	Default value: 25.00 Hz
Description:	Preset speed is selected with digital inputs using a binary input.			
P2.3.6[Ⓢ]	Preset speed 6			ID 121
Minimum value:	0.00 Hz	Maximum value:	MaxFreq Hz	Default value: 30.00 Hz
Description:	Preset speed is selected with digital inputs using a binary input.			

Table 23. Inputs (Cont.).

P2.3.7[®]	Preset speed 7			ID 122
Minimum value:	0.00 Hz	Maximum value:	MaxFreq Hz	Default value: 35.00 Hz
Description:	Preset speed is selected with digital inputs using a binary input.			

P2.4 - AI settings.

P2.4.1	AI mode			ID 222
Minimum value:	N.A.	Maximum value:	N.A.	Default value: 1

Options: 0 = 0 - 20 mA; or
1 = 0 - 10 V.







Description: Defines the analog input mode to current or voltage the DIP switches on control board will need to be set to the same mode as this parameter.

*DM1 PRO CN5 terminals 8 and 9 for current or voltage, also need to set DIP switches SW2 2 and 3 on control board, near the RJ45 port.

DIP switches SW2 2 and 3 off for voltage.

Current mode, if using the +10 V supply on CN5 terminals 13 of the DM1 / DM1 Pro, it will require DIP switches SW2 2 and 3 on to complete the current loop. When doing a current loop with an external supply, the DIP switches SW2 2 off and 3 on.

 Default

		SW2			
		OFF	ON		
CMA		1		CMA	
AI		2		AI	
AI 0 ~ 10 V		3		AI 4 ~ 20 mA	

Chapter 5 - Fan control application

Table 23. Inputs (Cont.).

P2.4.2^②	AI signal range			ID 175
Minimum value:	N.A.	Maximum value:	N.A.	Default value: 0
Options:	0 = 0-100%/0-20 mA/0-10 V. 1 = 20-100%/4-20 mA/2-10 V.			
Description:	With this parameter, you can select the analog input 1 signal range. For selection "Customized," see "AI Custom Min" and "AI Custom Max", this enables a customized signal range.			

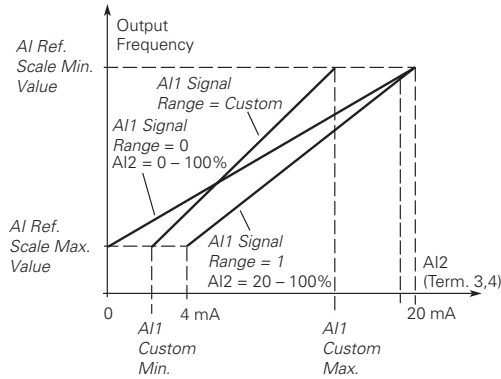

^① Parameter value can only be changed after the drive has stopped.

^② Parameter value will be set to be default when changing macros.

Table 24. Outputs.

P3.1 - Digital output.					
P3.1.1^②	RO1 function				ID 152
Minimum value:	N.A.	Maximum value:	N.A.	Default value:	2
Options:	0 = Not used - no action; 1 = Ready - drive is ready for operation; 2 = Run - drive is running; 3 = Fault - drive is faulted; 4 = Fault invert - drive is not faulted; 5 = Warning - drive has a warning message; 6 = Reverse - drive is outputting reverse phase rotation; 7 = At speed - drive output frequency has reached the set reference; 8 = Zero frequency - drive output is at zero frequency; 9 = Frequency limit supervision - supervision for frequency limit 1 is activated; 10 = PI supervision - supervision for PI controller is activated; 11 = Torque limit supervision - supervision for torque limit; 12 = Reference limit supervision - supervision for reference limit; 13 = Power limit supervision - supervision for power limit; 14 = Temperature limit supervision - supervision for drive temperature limit; 15 = Analog input supervision - supervision for analog input limit; 16 = Motor current supervision - supervision for motor current limit; 17 = Over heat fault - drive over heat fault has occurred; 18 = Over current regular - over current regulator is enabled; 19 = Over volt regular - over volt regulator is enabled; 20 = Under volt regular - under volt regulator is enabled; 21 = 4 mA fault - 4 mA fault has occurred; 22 = External fault - external fault has occurred; 23 = Motor thermal fault - motor thermal fault has occurred; 24 = STO fault output - safe torque Off input is activated; 25 = Control from IO - I/O is the selected start command location; 26 = Remote control - remote is the control place; 27 = Unrequested rotation direction - active direction is not the same as the reference direction; 28 = Fire mode - drive is in fire mode; 29 = Damper control - damper control output; 30 = Valve control - valve control output; 31 = Jog speed - drive is in jog mode; 32 = Fieldbus input 1 - controller by fieldbus control word; 33 = Fieldbus input 2 - controlled by fieldbus control word; 34 = DC charge switch close - DC pre-charge relay is closed; 35 = Preheat active - preheat control mode is activated; 36 = Cold weather active - cold weather mode is active ; 37 = PI sleep - PI controller is in a sleep state; 38 = 2nd stage ramp frequency active - Accel/Decel time 2 is active 39 = Prime pump active - drive is running in prime pump mode; 40 = Master drive state - indicates it is the master drive in the multi-pump control mode; 41 = Slave drive state - indicates it is the slave drive in the multi-pump control mode; or 43 = Single drive control - indicates the motor contactor is open or close in multi-pump control mode.				
Description:	Defines the function associated with changing the state of relay output 1.				

Table 24. Outputs (Cont.).

P3.1.4^②	RO2 function				ID 153
Minimum value:	N.A.	Maximum value:	N.A.	Default value:	3
Options:	0 = Not used - no action; 1 = Ready - drive is ready for operation; 2 = Run - drive is running; 3 = Fault - drive is faulted; 4 = Fault invert - drive is not faulted; 5 = Warning - drive has a warning message; 6 = Reverse - drive is outputting reverse phase rotation; 7 = At speed - drive output frequency has reached the set reference; 8 = Zero frequency - drive output is at zero frequency; 9 = Frequency limit supervision - supervision for frequency limit 1 is activated; 10 = PI supervision - supervision for PI controller is activated; 11 = Torque limit supervision - supervision for torque limit; 12 = Reference limit supervision - supervision for reference limit; 13 = Power limit supervision - supervision for power limit; 14 = Temperature limit supervision - supervision for drive temperature limit; 15 = Analog input supervision - supervision for analog input limit; 16 = Motor current supervision - supervision for motor current limit; 17 = Over heat fault - drive over heat fault has occurred; 18 = Over current regular - over current regulator is enabled; 19 = Over volt regular - over volt regulator is enabled; 20 = Under volt regular - under volt regulator is enabled; 21 = 4 mA fault - 4 mA fault has occurred; 22 = External fault - external fault has occurred; 23 = Motor thermal fault - motor thermal fault has occurred; 24 = STO fault output - safe torque Off input is activated; 25 = Control from IO - I/O is the selected start command location; 26 = Remote control - remote is the control place; 27 = Unrequested rotation direction - active direction is not the same as the reference direction; 28 = Fire mode - drive is in fire mode; 29 = Damper control - damper control output; 30 = Valve control - valve control output; 31 = Jog speed - drive is in jog mode; 32 = Fieldbus input 1 - controller by fieldbus control word; 33 = Fieldbus input 2 - controlled by fieldbus control word; 34 = DC charge switch close - DC pre-charge relay is closed; 35 = Preheat active - preheat control mode is activated; 36 = Cold weather active - cold weather mode is active ; 37 = PI sleep - PI controller is in a sleep state; 38 = 2nd stage ramp frequency active - Accel/Decel time 2 is active 39 = Prime pump active - drive is running in prime pump mode; 40 = Master drive state - indicates it is the master drive in the multi-pump control mode; 41 = Slave drive state - indicates it is the slave drive in the multi-pump control mode; or 43 = Single drive control - indicates the motor contactor is open or close in multi-pump control mode.				
Description:	Defines the function associated with changing the state of relay output 2.				
P3.3 - Analog output.					
P3.3.1^②	AO mode				ID 227
Minimum value:	N.A.	Maximum value:	N.A.	Default value:	0
Options:	0 = 0 - 20 mA; or 1 = 0 - 10 V.				
Description:	Defines the analog output mode to current or voltage.				

Table 24. Outputs (Cont.).

P3.3.2 [Ⓜ]	AO function			ID 146
Minimum value:	N.A.	Maximum value:	N.A.	Default value: 1
Options:	1 = Output frequency (0 max frequency); 2 = Frequency reference (0 - max frequency); 3 = Motor speed RPM (0 - nameplate RPM); 4 = Motor current (0 - nameplate current); 5 = Motor torque (0 - calculated nominal); 6 = Motor power (0 - calculated nominal); 7 = Motor voltage (0 - nameplate voltage); 8 = DC bus voltage (0 - 1000 Vdc); 9 = PI setpoint (process unit minimum - process unit maximum); 10 = PI error value (process unit minimum - process unit maximum); 11 = PI output (process unit minimum - process unit maximum); 12 = Analog input (0% - 100%); 13 = Drive reference potentiometer (0% - 100%); 14 = Fieldbus process data input 1 (0% - 100%); 15 = Fieldbus process data input 2 (0% - 100%); 16 = Fieldbus process data input 3 (0% - 100%); 17 = Fieldbus process data input 4 (0% - 100%); 18 = Fieldbus process data input 5 (0% - 100%); 19 = Fieldbus process data input 6 (0% - 100%); 20 = Fieldbus process data input 7 (0% - 100%); 21 = Fieldbus process data input 8 (0% - 100%); 22 = User defined output (user defined minimum - user defined maximum); 23 = Motor torque (0% - 200%); or 24 = Motor power absolute value (0% - 100%).			
Description:	Select the function desired to the terminal AO1.			

[Ⓜ] Parameter value will be set to be default when changing macros.

Table 25. Drive control.

P4.1 - Basic settings.				
P4.1.1 [Ⓜ]	Keypad reference			ID 141
Minimum value:	MinFreq	Maximum value:	MaxFreq	Default value: 0.00 Hz
Description:	Keypad reference value.			
P4.1.3 [Ⓜ]	Keypad stop			ID 114
Minimum value:	N.A.	Maximum value:	N.A.	Default value: 1
Options:	0 = Enabled - keypad operation - In this mode, the keypad stop will only operate when the control source is set to keypad. 1 = Always enabled - In this mode, the stop button will always stop the drive regardless of control mode.			
Description:	Enabled or always enabled keypad operation.			
P4.1.4 [Ⓜ]	Reverse enabled			ID 1679
Minimum value:	N.A.	Maximum value:	N.A.	Default value: 1
Options:	0 = Disabled; or 1 = Enabled.			
Description:	Enables or disables the reverse motor direction.			
P4.1.5	Change phase sequence motor			ID 2515
Minimum value:	N.A.	Maximum value:	N.A.	Default value: 0
Options:	0 = Change disable; or 1 = Change enable.			
Description:	This parameter allows for swapping the motor phase output from u, v, w to u, w, v.			

Table 25. Drive control (Cont.)

P4.1.6^②	Power up local remote select			ID 1685
Minimum value:	N.A.	Maximum value:	N.A.	Default value: 0
Options:	0 = Hold last; 1 = Local control; or 2 = Remote control.			
Description:	Selects what control place the drive will start at after power is applied. The default setting will hold the last state that the drive was in when powered down, selecting Local or Remote will cause the drive to start in that mode regardless of last state.			
P4.1.8^②	Start mode			ID 252
Minimum value:	N.A.	Maximum value:	N.A.	Default value: 0
Options:	0 = Ramp - The drive starts from 0 Hz and ramps to the frequency reference value. 1 = Flying start from stop frequency - The drive will catch a spinning motor. This setting searches for the current frequency using the last operating frequency as a starting point. 2 = Flying start from maximum frequency - The drive will catch a spinning motor. This setting searches for the current frequency using the maximum operating frequency as a starting point.			
Description:	Selects the start mode operation.			
P4.1.9^②	Stop mode			ID 253
Minimum value:	N.A.	Maximum value:	N.A.	Default value: 1
Options:	0 = Coasting - After a stop command, the motor coasts to a stop uncontrolled by the drive. 1 = Ramp - After the stop command, the speed of the motor is decelerated according to the set deceleration parameters.			
Description:	Selects the stop mode operation.			
P4.1.10^②	Ramp 1 shape			ID 247
Minimum value:	0.0 s	Maximum value:	10.0 s	Default value: 0.0 s
Description:	The start and end of the acceleration and deceleration ramps can be smoothed with these parameters. Setting a value of 0.00 seconds gives a linear ramp shape that causes acceleration and deceleration to react immediately to the changes in the reference signal. Setting a value from 0.10 to 10.00 seconds for this parameter produces an S-shaped acceleration/deceleration at the start and stop of the slope.			

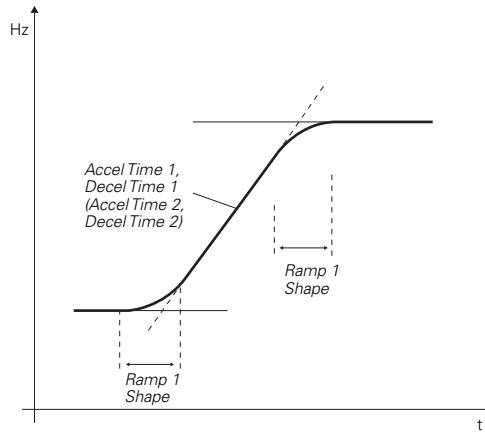

Table 25. Drive control (Cont.)

P4.1.11^②	Ramp 2 shape			ID 248
Minimum value:	0.0 s	Maximum value:	10.0 s	Default value: 0.0 s
Description:	<p>The start and end of the acceleration and deceleration ramps can be smoothed with these parameters. Setting a value of 0.00 gives a linear ramp shape that causes acceleration and deceleration to react immediately to the changes in the reference signal.</p> <p>Setting a value from 0.10 to 10.00 seconds for this parameter produces an S-shaped acceleration/deceleration at the start and stop of the slope.</p>			
P4.1.12^②	Accel. time 2			ID 249
Minimum value:	0.1 s	Maximum value:	3000.0 s	Default value: 10.0 s
Description:	<p>These values correspond to the time required for the output frequency to accelerate from the zero frequency to the set maximum frequency.</p> <p>These parameters provide the possibility to set two different acceleration/deceleration time sets for one application. The active set can be selected with the programmable digital input.</p>			
P4.1.13^②	Decel. time 2			ID 250
Minimum value:	0.1 s	Maximum value:	3000.0 s	Default value: 10.0 s
Description:	<p>These values correspond to the time required for the output frequency to decelerate from the set maximum frequency to the zero frequency.</p> <p>These parameters provide the possibility to set two different acceleration/deceleration time sets for one application. The active set can be selected with the programmable digital input.</p>			
P4.1.14^{①②}	2nd Stage ramp frequency			ID 2444
Minimum value:	MinFreq.	Maximum value:	MaxFreq.	Default value: 30.00 Hz
Description:	<p>When 2nd stage ramp frequency is the frequency level at which the drive will enable the 2nd stage ramp frequency output function. This then can be used for other inputs or devices to signal a frequency level.</p>			

① Parameter value can only be changed after the drive has stopped.

② Parameter value will be set to be default when changing macros.

Table 26. Motor control.

P5.1 - Basic settings.				
P5.1.1^{①②}	Motor control mode			ID 287
Minimum value:	N.A.	Maximum value:	N.A.	Default value: 0
Options:	0 = Frequency control - Output frequency is controlled directly by the frequency reference. 1 = Speed control - Output frequency is controlled by giving a frequency reference to it with slip compensation. 2 = Open loop vector control - Similar to the standard speed control mode, higher performance slip calculation requires running a motor identification. 3 = PM control 1 - PM motor control mode 1, used for SPM (surface mounted permanent magnet) and it also can be used for IPM. 4 = PM control 2 - PM motor control mode 2, used for IPM (internally mounted permanent magnet) and it can not be used for SPM.			
Description:	Selects the motor control mode.			
P5.1.2^①	Current limit			ID 107
Minimum value:	DriveNomCurrCT*1/10 A	Maximum value:	DriveNomCurrCT*2 A	Default value: DriveNomCurrCT*3/2 A
Description:	This parameter determines the maximum output current allowed from the drive. The parameter value range differs from size to size. Once the motor current hits this level, it goes into the current limiter controller and tries to limit the output current.			
P5.1.3^{①②}	V/Hz optimization			ID 109
Minimum value:	N.A.	Maximum value:	N.A.	Default value: 0
Options:	0 = Disable torque boost function. 1 = Enable torque boost function.			
Description:	Automatic torque boost - the voltage to the motor increases automatically, which assists the motor to produce sufficient torque to start and run at low frequencies with high loads.			
P5.1.4^{①②}	V/Hz ratio			ID 108
Minimum value:	N.A.	Maximum value:	N.A.	Default value: 0
Options:	0 = Linear - the voltage of the motor changes linearly with the frequency in the constant flux area from 0 Hz to the field weakening point where the nominal voltage is supplied. A linear V/Hz ratio should be used in constant torque applications. 1 = Squared - the voltage of the motor changes following a squared curve with the frequency in the area from 0 Hz to the field weakening point where the nominal voltage is supplied. The motor runs under magnetized below the field weakening point and produces less torque and electromechanical noise. A squared V/Hz ratio can be used in applications where the torque demand of the load is proportional to the square of the speed. 2 = Programmable V/Hz curve - the V/Hz curve can be programmed with three different points. These points are the 0 frequency voltage, midpoint, and weakening point. A programmable V/Hz curve can be used if the other settings do not satisfy the needs of the application. 3 = Linear with flux optimization - the drive starts to search for the minimum motor current in order to save energy. This mode is called Eaton's Active Energy Control which will reduce the voltage and current but still maintain the desired speed.			
Description:	Selects the V/Hz ratio. 0 = Linear; 1 = Squared; 2 = Programmable; or 3 = Linear + flux optimization.			
 <p style="text-align: center;">0 = Linear and 1 = Squared.</p>				
P5.1.10^②	Switching frequency			ID 288
Minimum value:	MinSwitchFreq kHz	Maximum value:	MaxSwitchFreq kHz	Default value: DefaultSwitchFreqCT kHz
Description:	Sets the switching frequency for the PWM output waveform.			

Table 26. Motor control (Cont.).

P5.1.16^{①②}	Identification			ID 299
Minimum value:	N.A.	Maximum value:	N.A.	Default value: 0
Options:	0 = Not action. 1 = Identification only stator resistor - does not spin the motor. This can be done with load attached. 2 = Identification with run - motor stator resistor is completed then the motor is run. This must be completed with unloaded motor. 3 = Identification no run - motor is supplied with current and voltage but at zero frequency. 4 = Identification only inertia - identification for the system inertia only.			
Description:	This parameter enables the drive to make an motor identification cycle of the motor once complete the drive will adjust tuning parameters to improve starting torque and open loop vector control performance. Once set and a run command is given, the operation will be active then set back to 0 when completed. When a run command is issued, the message on the keypad will indicate "Auto tuning" is being performed. If there is an issue with the motor identification, a fault message will be displayed.			

① Parameter value can only be changed after the drive has stopped.

② Parameter value will be set to be default when changing macros.

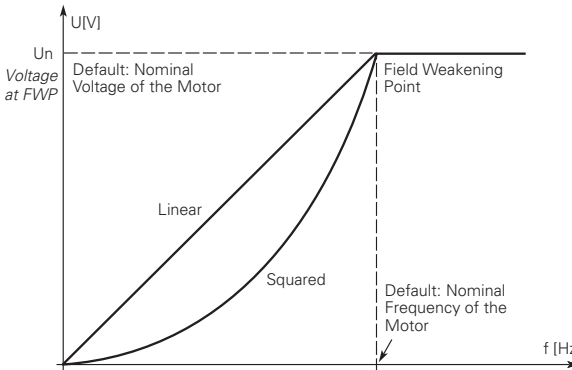
Table 27. Protections .

P6.1 - Motor.				
P6.1.4^{①②}	Motor thermal protection			ID 310
Minimum value:	N.A.	Maximum value:	N.A.	Default value: 2
Options:	0 = No response. 1 = Warning. 2 = Fault, stop mode after fault according to parameter stop mode. 3 = Fault, stop mode after fault always by coasting.			
Description:	If a fault condition is selected, the drive will stop and activate the fault stage based off the % of calculated motor temperature. The calculated motor temp is based off the install power on values of the drive and monitoring values as the drive is running. Deactivating this protection, i.e., setting parameter to 0, will reset the thermal stage of the motor to 0%.			
P6.1.5^②	Motor thermal FO current			ID 311
Minimum value:	0.00%	Maximum value:	150.00%	Default value: 100.00%
Description:	The current can be set between 0 - 150.0% x InMotor. This parameter sets the value for thermal current at zero frequency. The default value is set assuming that there is no external fan cooling the motor. If an external fan is used, this parameter can be set to 90% (or even higher).			
	<p>Note: The value is set as a percentage of the motor nameplate data, P1.6 (nominal current of the motor), not the drive's nominal output current. The motor's nominal current is the current that the motor can withstand in direct on-line use without being overheated. If you change the parameter nominal current of motor, this parameter is automatically restored to the default value. Setting this parameter does not affect the maximum output current of the drive.</p>			

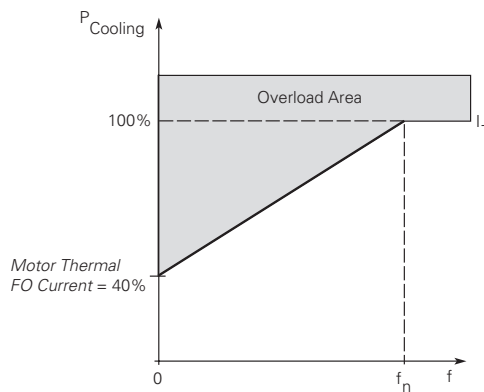

Chapter 5 - Fan control application

Table 27. Protections (Cont.).

P6.2.2^{①②}	Input phase fault			ID 332
Minimum value:	N.A.	Maximum value:	N.A.	Default value: 2
Options:	0 = No response; 1 = Warning; 2 = Fault, stop mode after fault according to parameter stop mode; 3 = Fault, stop mode after fault always by coasting; or 4 = Single phase power limit.			
Description:	The input phase supervision ensures that the input phases of the frequency converter have approximately equal current draw.			
P6.2.3^{①②}	4 mA input fault			ID 306
Minimum value:	N.A.	Maximum value:	N.A.	Default value: 0
Options:	0 = No response. 1 = Warning. 2 = Warning, the frequency from 10 seconds back is set as reference. 3 = Warning, the preset frequency P6.2.4 is set as reference. 4 = Fault, stop mode after fault according to parameter stop mode. 5 = Fault, stop mode after fault always by coasting.			
Description:	A warning or a fault action and message is generated if the 4 - 20 mA reference signal is used and the signal falls below 4 mA for 5 seconds, or below 0.5 mA for 0.5 seconds. The information can also be programmed into relay outputs R01 and R02.			
P6.2.4^{①②}	4 mA fault frequency			ID 331
Minimum value:	0.00 Hz	Maximum value:	MaxFreq Hz	Default value: 0.00 Hz
Description:	When 4 mA fault happens, the output frequency of drive goes to this preset speed when P6.2.3 = 3.			
P6.2.5^{①②}	External fault			ID 307
Minimum value:	N.A.	Maximum value:	N.A.	Default value: 2
Options:	0 = No action; 1 = Warning; 2 = Fault, stop mode after fault according to parameter stop mode. 3 = Fault, stop mode after fault always by coasting.			
Description:	A warning or a fault action and message is generated from the external fault signal in the programmable (digital inputs function select external fault). The status information can also be programmed into digital output relay outputs R01 and R02.			
P6.2.11^②	STO fault response			ID 2427
Minimum value:	N.A.	Maximum value:	N.A.	Default value: 2
Options:	0 = No Action - drive will stop, no indication shown, no reset required, have to cycle start command. 1 = Warning - drive indicate warning/if STO clears drive will run without reset. 2 = Fault - drive will indicate fault/require reset to start again.			
Description:	STO fault response defines the function of how the STO input will be seen on the keypad and how the drive functions to it.			
P6.2.12^①	PI feedback AI loss response			ID 2401
Minimum value:	N.A.	Maximum value:	N.A.	Default value: 0
Options:	0 = No action; 1 = Warning; 2 = Fault; or 3 = Warning: preset frequency (P6.2.13).			
Description:	This parameter defines the function of the PI feedback analog input loss response. If the AI feedback is lost based off the programed AI feedback.			
P6.2.13^{①②}	PI feedback AI loss pre-frequency			ID 2402
Minimum value:	0.00 Hz	Maximum value:	400.00 Hz	Default value: 0.00 Hz
Description:	This parameter defines the frequency the master would run to if a feedback is lost and P6.2.12 was set to option 3.			
P6.2.14^②	PI feedback AI loss pipe fill			ID 2403
Minimum value:	0.0 varies	Maximum value:	1000.0 varies	Default value: 0.0 varies
Description:	Detects loss of prime in the pump based off the measured level. If the value drops below this level for the time in P6.2.15 and below, the frequency in P6.2.13 "loss of prime" occurs.			

Table 27. Protections (Cont.).

P6.2.15^②	PI feedback AI loss pre-frequency timeout			ID 2404
Minimum value:	0 s	Maximum value:	6,000 s	Default value: 0 s
Description:	PI feedback AI loss pre-frequency timeout - when P6.2.12 is set to 3 or 4, when the feedback signal is lost, the drive will run at the frequency in P6.2.15 for the time set here. After this time, the drive will fault out on "feedback loss". The time is disabled when set to 0 seconds.			
P6.3 - Communications.				
P6.3.1^{①②}	Fieldbus fault response			ID 334
Minimum value:	N.A.	Maximum value:	N.A.	Default value: 2
Options:	0 = No action; 1 = Warning; 2 = Fault; or 3 = Fault, coast.			
Description:	This sets the response mode for the fieldbus fault when a fieldbus mode is used and communication is lost between the PLC and communication port. Each protocol has another parameter to select in all control or only in fieldbus control to set fault or warning.			
P6.3.2^{①②}	OPTcard fault response			ID 335
Minimum value:	N.A.	Maximum value:	N.A.	Default value: 2
Options:	0 = No action; 1 = Warning; 2 = Fault; or 3 = Fault, coast.			
Description:	This sets the response mode for a board slot fault caused by a missing or failed option board not communicating to the central processor.			

^① Parameter value can only be changed after the drive has stopped.

^② Parameter value will be set to be default when changing macros.

Table 28. PI Controller.

P7.1 - Basic settings.				
P7.1.1^②	PI control itime			ID 1294
Minimum value:	0.00%	Maximum value:	200.00%	Default value: 100.00%
Description:	Defines the gain of the PI Controller. It adjust the slope of the speed increase according to the initial of the load. If this value is set to 100%, a change of 10% in the error value causes the controller output to change 10%.			
P7.1.2^②	PI control gain			ID 1295
Minimum value:	0.00 s	Maximum value:	600.00 s	Default value: 1.00 s
Description:	Defines the integration time of the PI controller. Over the time, the integral time contributes to the deviation between the reference and the feedback signal. If this value is set to 1.00 sec., a change of 10% in the error value causes the controller output to change by 10.00%/s.			

Table 28. PI Controller (Cont.).

P7.1.3^{①②}	PI process unit			ID 1297
Minimum value:	N.A.	Maximum value:	N.A.	Default value: 0
Options:	0 = %; 1 = 1/min.; 2 = rpm; 3 = ppm; 4 = pps; 5 = l/s; 6 = l/min.; 7 = l/h; 8 = kg/s; 9 = kg/min.; 10 = kg/h; 11 = m ³ /s; 12 = m ³ /min.; 13 = m ³ /h; 14 = m/s; 15 = mbar; 16 = bar; 17 = Pa; 18 = kPa; 19 = mV/S; 20 = kW; 21 = Deg. C; 22 = GPM; 23 = gal/s; 24 = gal/min.; 25 = gal/h; 26 = lb/s; 27 = lb/min.; 28 = lb/h; 29 = CFM; 30 = ft ³ /s; 31 = ft ³ /min.; 32 = ft ³ /h; 33 = ft/s; 34 = in. wg; 35 = ft wg; 36 = PSI; 37 = lb/in.2; 38 = HP; 39 = Deg. F; 40 = PA; 41 = W/C; 42 = HG; 43 = ft; 44 = m;			
Description:	Defines the unit type for PI feedback unit.			
P7.1.4^②	PI process unit minimum			ID 1298
Minimum value:	-99999.99 varies	Maximum value:	PID1_ProcessUnitMax varies	Default value: 0.00 varies
Description:	Defines the minimum process unit value.			
P7.1.5^②	PI process unit maximum			ID 1300
Minimum value:	PID1_ProcessUnitMin	Maximum value:	99999.99 varies	Default value: 100.00 varies
Description:	Defines the maximum process unit value.			
P7.1.6^{①②}	PI error inversion			ID 1303
Minimum value:	N.A.	Maximum value:	N.A.	Default value: 0
Options:	0 = Normal - if feedback is less than set-point, PI controller output increases. 1 = Inverted - if feedback is less than set-point, PI controller output decreases.			
Description:	Defines the way the process value output reacts to the feedback signal.			

Table 28. PI Controller (Cont.).

P7.1.7^②	PI dead band			ID 1304
Minimum value:	-99999.99 varies	Maximum value:	99999.99 varies	Default value: 0 varies
Description:	PI dead band around setpoint in process units. This is the band where no actions occur to prevent oscillation or repeated activation/deactivation of controller. The PI output is locked if the feedback stays within the dead band area.			
P7.1.8^②	PI dead band delay			ID 1306
Minimum value:	0.00 s	Maximum value:	320.00 s	Default value: 0.00 s
Description:	If the PI process value goes out of the dead band area for the desired time delay, at that point the controller will re-initialize and try to level out again.			
P7.1.9^②	PI ramp time			ID 1311
Minimum value:	0.00 s	Maximum value:	300.00 s	Default value: 0.00 s
Description:	Defines the rising and falling ramp times for changes in the process value.			

① Parameter value can only be changed after the drive has stopped.

② Parameter value will be set to be default when changing macros.

Table 29. Setpoint.

P7.2.1 - Standard.				
P7.2.1.1^②	PI keypad setpoint 1			ID 1307
Minimum value:	PI Process Unit Min	Maximum value:	PI Process Unit Max	Default value: 0.00 varies
Description:	Keypad PI reference value setpoint 1.			
P7.2.1.2^②	PI keypad setpoint 2			ID 1309
Minimum value:	PI Process Unit Min	Maximum value:	PI Process Unit Max	Default value: 0.00 varies
Description:	Keypad PI reference value setpoint 2.			
P7.2.1.3^②	PI wake-up action			ID 2466
Minimum value:	N.A.	Maximum value:	N.A.	Default value: 0
Options:	0 = Wake-up when below wake-up level. 1 = Wake-up when above wake-up-level. 2 = Wake-up when below wake-up level % from PI setpoint. 3 = Wake-up when above wake-up level %from PI setpoint.			
Description:	This parameter defines the wake-up function action.			
P7.2.2 - Setpoint 1.				
P7.2.2.1^{①②}	PI setpoint 1 source			ID 1312
Minimum value:	N.A.	Maximum value:	N.A.	Default value: 1
Options:	0 = Not used; 1 = PI keypad setpoint 1; 2 = PI keypad setpoint 2; 3 = AI; 4 = Drive reference pot; 5 = FB process data input 1; 6 = FB process data input 2; 7 = FB process data input 3; 8 = FB process data input 4; 9 = FB process data input 5; 10 = FB process data input 6; 11 = FB process data input 7; 12 = FB process data input 8; 13 = FB PI setpoint 1; or 14 = FB PI setpoint 2.			
Description:	Defines source of the setpoint value the drive uses. This can either be an internal preset value, keypad setpoint, analog signal, or fieldbus message.			

Table 29. Setpoint (Cont.).

P7.2.2.2 ^{①②}	PI setpoint 1 sleep enable			ID 1315
Minimum value:	N.A.	Maximum value:	N.A.	Default value: 0
Options:	0 = Disabled; or 1 = Enabled.			
Description:	This function will disable the output when the frequency drops below the sleep frequency for the sleep delay time. The output re-engages when feedback rises above the wake-up level.			
P7.2.2.3 ^②	PI setpoint 1 sleep delay			ID 1317
Minimum value:	0 s	Maximum value:	3,000 s	Default value: 0 s
Description:	This parameter sets the delay time after the setpoint drops below the sleep level for this amount of time and then the drives output will shut off till the wake up level is met. It is to prevent large fluctuations when going into the sleep function to save motor run time.			
P7.2.2.4 ^②	PI setpoint 1 wake-up level			ID 1318
Minimum value:	-99999.99 varies	Maximum value:	99999.99 varies	Default value: 0.00 varies
Description:	Defines the level for the PI feedback value to go above top enable the PI output to be re enabled. This value is based of the % of feedback which can be scaled based off the PI unit min./max, values.			
P7.2.2.5 ^②	PI setpoint 1 boost			ID 1320
Minimum value:	-2.00 varies	Maximum value:	2.00 varies	Default value: 1.00 varies
Description:	The setpoint can be boosted via a multiplier value.			
P7.2.2.6 ^②	PI setpoint 1 sleep level			ID 2450
Minimum value:	Min Freq	Maximum value:	Max Freq	Default value: 0.00 Hz
Description:	Defines the level of which the unit value is used to look at to go into the sleep mode. When the unit drops below this level for the sleep delay time, it will put the drive into the sleep mode.			
P7.2.2.7 ^②	SP1 sleep mode over cycle time			ID 1842
Minimum value:	0	Maximum value:	10	Default value: 0
Description:	Defines the count the drive come in and out of sleep mode. If multiple times done in this time frame, the drive would trip on "pump over cycle" fault. One cycle is defined when the drive transfers from normal mode to sleep mode. 0 value means do not do the sleep over cycle check and clear "pump over cycle" fault.			
P7.2.2.8 ^②	SP1 sleep mode maximum cycle time			ID 1843
Minimum value:	0	Maximum value:	3,600	Default value: 0
Description:	Defines the maximum time for sleep over cycle checking.			
P7.2.3 - Setpoint 2.				
P7.2.3.1 ^{①②}	PI setpoint 2 source			ID 1321
Minimum value:	N.A.	Maximum value:	N.A.	Default value: 1
Options:	0 = Not used; 1 = PI keypad setpoint 1; 2 = PI keypad setpoint 2; 3 = AI; 4 = Drive reference pot; 5 = Fieldbus process data input 1; 6 = Fieldbus process data input 2; 7 = Fieldbus process data input 3; 8 = Fieldbus process data input 4; 9 = Fieldbus process data input 5; 10 = Fieldbus process data input 6; 11 = Fieldbus process data input 7; 12 = Fieldbus process data input 8; 13 = Fieldbus PI setpoint 1; or 14 = Fieldbus PI setpoint 2.			
Description:	Defines source of the setpoint value the drive uses. This can either be an internal preset value, keypad setpoint, analog signal, or fieldbus message.			

Table 29. Setpoint (Cont.).

P7.2.3.2 ^{①②}	PI setpoint 2 sleep enable			ID 1324
Minimum value:	N.A.	Maximum value:	N.A.	Default value: 0
Options:	0 = Disabled; or 1 = Enabled.			
Description:	This function will disable the output when the frequency drops below the sleep frequency for the sleep delay time. The output re-engages when feedback rises above the wake-up level.			
P7.2.3.3 ^②	PI setpoint 2 sleep delay			ID 1326
Minimum value:	0 s	Maximum value:	3,000 s	Default value: 0 s
Description:	This parameter sets the delay time after the setpoint drops below the sleep level for this amount of time and then the drives output will shut off till the wake up level is met. It is to prevent large fluctuations when going into the sleep function to save motor run time.			
P7.2.3.4 ^②	PI setpoint 2 wake-up level			ID 1327
Minimum value:	-99999.99 varies	Maximum value:	99999.99 varies	Default value: 0.00 varies
Description:	Defines the level for the PI feedback value to go above top enable the PI output to be re enabled. This value is based of the % of feedback which can be scaled based off the PI unit min./max, values.			
P7.2.3.5 ^②	PI setpoint 2 boost			ID 1329
Minimum value:	-2.00 varies	Maximum value:	2.00 varies	Default value: 1.00 varies
Description:	The setpoint can be boosted via a multiplier value.			
P7.2.3.6 ^②	PI setpoint 2 sleep level			ID 2452
Minimum value:	Min Freq	Maximum value:	Max Freq	Default value: 0.00 Hz
Description:	Defines the level of which the unit value is used to look at to go into the sleep mode. When the unit drops below this level for the sleep delay time, it will put the drive into the sleep mode.			
P7.2.3.7 ^②	SP2 sleep mode over cycle time			ID 1844
Minimum value:	0	Maximum value:	10	Default value: 0
Description:	Defines the count the drive come in and out of sleep mode. If multiple times done in this time frame, the drive would trip on "pump over cycle" fault. One cycle is defined when the drive transfers from normal mode to sleep mode. 0 value means do not do the sleep over cycle check and clear "pump over cycle" fault.			
P7.2.3.8 ^②	SP2 sleep mode maximum cycle time			ID 1845
Minimum value:	0	Maximum value:	3,600	Default value: 0
Description:	Defines the maximum time for sleep over cycle checking.			

① Parameter value can only be changed after the drive has stopped.

② Parameter value will be set to be default when changing macros.

Table 30. Feedback .

P7.3.1 - Standard.				
P7.3.1.1 ^②	PI feedback gain			ID 1331
Minimum value:	-1,000.00%	Maximum value:	1,000.00%	Default value: 100.00%
Description:	Defines gain associated with the feedback signal from the measuring device.			

Table 30. Feedback (Cont.).

P7.3.2 - Feedback 1.					
P7.3.2.1^{①②}	PI feedback 1 source				ID 1332
Minimum value:	N.A.	Maximum value:	N.A.	Default value:	2
Options:	0 = Not used; 1 = AI; 2 = Drive reference pot; 3 = Fieldbus process data input 1; 4 = Fieldbus process data input 2; 5 = Fieldbus process data input 3; 6 = Fieldbus process data input 4; 7 = Fieldbus process data input 5; 8 = Fieldbus process data input 6; 9 = Fieldbus process data input 7; 10 = Fieldbus process data input 8; or 11 = Fieldbus PI feedback.				
Description:	Defines where feedback signal is being fed into the drive, via analog or fieldbus data value.				
P7.3.2.2^②	PI feedback 1 minimum				ID 1333
Minimum value:	-200.00 %	Maximum value:	200.00%	Default value:	0.00%
Description:	Minimum unit value for the feedback signal.				
P7.3.2.3^②	PI feedback 1 maximim				ID 1334
Minimum value:	-200.00 %	Maximum value:	200.00%	Default value:	100.00%
Description:	Maximim unit value for the feedback signal.				

① Parameter value can only be changed after the drive has stopped.

② Parameter value will be set to be default when changing macros.

Table 31. HVAC parameters.

P8.1 - Damper (*DM1 PRO).					
P8.1.1^{①②}	Damper start				ID 483
Minimum value:	N.A.	Maximum value:	N.A.	Default value:	0
Options:	0 = Normal; 1 = Damper start; 2 = Damper tout; or 3 = Damper delay.				
Description:	This parameter determines the function of th damper.				
P8.1.2^{①②}	Damper time out				ID 484
Minimum value:	1 s	Maximum value:	32,500 s	Default value:	5 s
Description:	The time out time used for an interlocked time start, after which the start sequence must be restarted if no acknowledgement contact is received.				
P8.1.3^{①②}	Damper delay				ID 485
Minimum value:	1 s	Maximum value:	32,500 s	Default value:	5 s
Description:	The delay time following a delay start, after which the frequency converter will be started.				
P8.2 - Fire mode (*DM1 PRO).					
P8.2.1^{①②}	Fire mode protection				ID 535
Minimum value:	N.A.	Maximum value:	N.A.	Default value:	0
Options:	0 = Closing contact initiates fire mode function. 1 = Opening contact initiates fire mode function.				
Description:	This parameter determines whether the fire mode function is determined by a contact closure or contact opening on the desired digital input function select fire mode. Note: When fire mode is enabled, this causes the drive to ignore any fault and run till its death. Warranty will be non-valid in the case this is enabled and the drive causes issues to the system.				

Table 31. HVAC parameters (Cont.).

P8.2.2 ^{①②}	Fire mode reference select function			ID 536
Minimum value:	N.A.	Maximum value:	N.A.	Default value: 0
Options:	0 = Fire mode minimum frequency; 1 = Fire mode reference; 2 = Fieldbus reference - reference from fieldbus process in; 3 = AI; or 4 = PI1 control - follows the PI control algorithm settings.			
Description:	This parameter allows for setting the reference location for when the fire mode is enabled.			
P8.2.3 ^②	Fire mode minimum frequency			ID 537
Minimum value:	MinFreq Hz	Maximum value:	MaxFreq Hz	Default value: 15.00 Hz
Description:	This parameter sets the minimum output frequency for fire mode. This can be used as a selection for reference command.			
P8.2.4 ^②	Fire mode frequency reference 1			ID 565
Minimum value:	0.00%	Maximum value:	100.00%	Default value: 75.00%
Description:	This parameter sets the drive operating percentage based off the 0% being minimum frequency (P1.1) and 100% being maximum frequency (P1.2) for fire mode reference 1.			
P8.2.5 ^②	Fire mode frequency reference 2			ID 564
Minimum value:	0.00%	Maximum value:	100.00%	Default value: 100.00%
Description:	This parameter sets the drive operating percentage based off the 0% being minimum frequency (P1.1) and 100% being maximum frequency (P1.2) for fire mode reference 2.			
P8.2.6	Fire mode test enable			ID 2443
Minimum value:	N.A.	Maximum value:	N.A.	Default value: N.A.
Options:	0 = Disabled; or 1 = Enabled.			
Description:	This parameter allows for testing the fire mode feature. With the parameter set to enable and fire mode input enabled, the drive will run at the fire mode speed desired but all faults are enabled.			
P8.2.7 ^{①②}	Smoke purge frequency			ID 554
Minimum value:	0.00%	Maximum value:	100.00%	Default value: 50.00%
Description:	Frequency setting for smoke purge. Preset speed used for a digital input selection. The percentage is based off the 0% being minimum frequency (P1.1) and 100% being maximum frequency (P1.2).			
P8.3 - Protections (*DM1 PRO).				
P8.3.1 ^{①②}	Broken belt protection			ID 317
Minimum value:	N.A.	Maximum value:	N.A.	Default value: 0
Options:	0 = No action; 1 = Warning; 2 = Fault; or 3 = Fault, coast.			
Description:	If fault is set as the function, the drive will stop and activate the fault stage based on the parameter conditions and the monitoring status of the motor. If the motor torque drops below the Fnom and F0 torque levels for the time limit, the protection is enabled. Deactivating the protection by setting the parameter to 0 will reset the underload time counter to zero.			

Table 31. HVAC parameters (Cont.).

P8.3.2[Ⓢ]	Broken belt Fnom torque			ID 318
Minimum value:	10.00%	Maximum value:	150.00%	Default value: 50.00%

Description: The torque limit can be set between 10.0-150.0 % x TnMotor. This parameter gives the value for the minimum torque allowed when the output frequency is at or above the field weakening point. If you change P1.6, nominal motor current, this parameter is automatically restored to the default value.

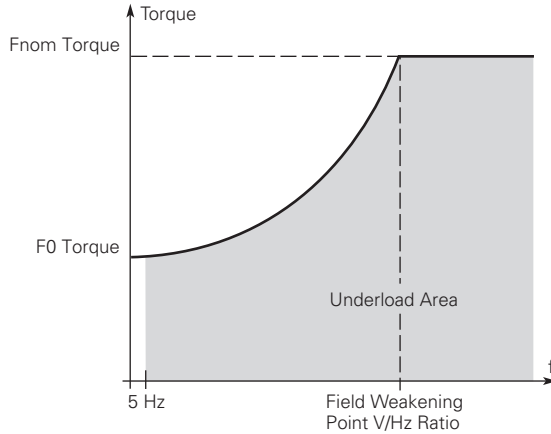

P8.3.3[Ⓢ]	Broken belt F0 torque			ID 319
Minimum value:	5.00%	Maximum value:	150.00%	Default value: 10.00%

Description: The torque limit can be set between 5.0–150.0 % x TnMotor. This parameter gives the value for the minimum torque allowed at zero frequency. If you change the value of P1.6, nominal motor current, this parameter is automatically restored to the default value.

P8.3.4[Ⓢ]	Broken belt time limit			ID 320
Minimum value:	2.00 s	Maximum value:	600.00 s	Default value: 20.00 s

Description: This time can be set between 2.00 and 600.00 seconds. This is the time allowed for an fault state to exist. An internal up/down counter counts the accumulated underload time. If the underload counter value goes above this limit, the protection will cause a trip according to protection parameter. If the drive is stopped, the counter is reset to zero.

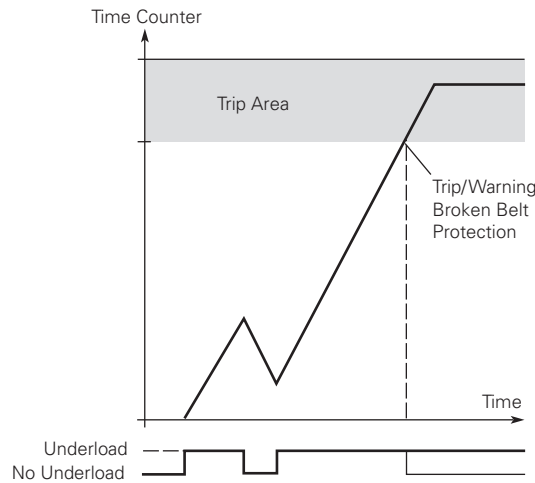

Parameter value can only be changed after the drive has stopped.
[Ⓢ] Parameter value will be set to be default when changing macros.

Table 32. Serial communication.

P11.1 - Basic settings.				
P11.1.1^①	Serial communication			ID 586
Minimum value:	N.A.	Maximum value:	N.A.	Default value: 0
Options:	0 = Modbus RTU; 1 = BACnet MS/TP (DM1 PRO); or 2 = SWD (DM1 PRO).			
Description:	This parameter defines the communication protocol for RS-485.			
P11.2 - Modbus RTU.				
P11.2.1^①	Slave address			ID 587
Minimum value:	1	Maximum value:	247	Default value: 1
Description:	This parameter defines the slave address for RS-485 communication.			
P11.2.2^①	Baud rate			ID 584
Minimum value:	N.A.	Maximum value:	N.A.	Default value: 1
Options:	0 = 9,600; 1 = 19,200; 2 = 38,400; 3 = 57,600; or 4 = 115,200			
Description:	This parameter defines communication speed for RS-485 communication.			
P11.2.3^①	Parity type			ID 585
Minimum value:	N.A.	Maximum value:	N.A.	Default value: 2
Options:	0 = None; 1 = Odd; or 2 = Even.			
Description:	This parameter defines parity type for RS-485 communication.			
P11.2.4	Modbus RTU protocol status			ID 588
Minimum value:	N.A.	Maximum value:	N.A.	Default value: N.A.
Options:	0 = Initial; 1 = Stopped; 2 = Operational; or 3 = Faulted.			
Description:	This parameter shows the protocol status for RS-485 communication.			
P11.2.5	Communication timeout modbus RTU			ID 593
Minimum value:	0 ms	Maximum value:	60,000 ms	Default value: 10,000 ms
Description:	Selects the time to wait before a communication fault occurs over modbus RTU if a message is not received.			
P11.2.6	Modbus RTU fault response			ID 2516
Minimum value:	N.A.	Maximum value:	N.A.	Default value: 0
Options:	0 - Only in fieldbus control mode. When fieldbus is the control place and fieldbus fault is active, the drive will fault on loss of communications; if not in fieldbus control, place will not fault. 1 - In all control modes. No matter the control place setting, if communication is lost, fieldbus fault response will occur.			
Description:	Defines the fieldbus fault condition for modbus RTU communication.			
P11.3 - BACnet RTU MSTP.				
P11.3.1^①	MSTP baud rate			ID 594
Minimum value:	N.A.	Maximum value:	N.A.	Default value: 2
Options:	0 = 9,600; 1 = 19,200; 2 = 38,400; 3 = 76,800; or 4 = 115,200.			
Description:	This parameter defines the communication speed for RS-485 communication.			

Table 32. Serial communication (Cont.).

P11.3.2^①	MSTP device address			ID 595
Minimum value:	0	Maximum value:	127	Default value: 1
Description:	Defines the device address of the drive on the BACnet MSTP network.			
P11.3.3^①	MSTP instance number			ID 596
Minimum value:	0	Maximum value:	4,194,302	Default value: 0
Description:	Defines the instance number of the drive on the BACnet MSTP network.			
P11.3.4	MSTP communication timeout			ID 598
Minimum value:	0 ms	Maximum value:	60,000 ms	Default value: 10,000 ms
Description:	Selects the time to wait before a communication fault occurs over BACnet MSTP if a message is not received.			
P11.3.5	MSTP protocol status			ID 599
Minimum value:	N.A.	Maximum value:	N.A.	Default value: N.A.
Options:	0 = Stopped; 1 = Operational; or 2 = Faulted.			
Description:	This parameter shows the protocol status for BACnet MSTP communication.			
P11.3.6	MSTP fault code			ID 600
Minimum value:	N.A.	Maximum value:	N.A.	Default value: N.A.
Options:	0 = None; 1 = Sole master; 2 = Duplicate MAC ID; or 3 = Baud rate fault.			
Description:	This parameter shows the protocol status for BACnet MSTP communication.			
P11.3.7	MSTP fault response			ID 2526
Minimum value:	N.A.	Maximum value:	N.A.	Default value: 0
Options:	0 = Only in fieldbus control mode - when fieldbus is the control place and fieldbus fault is active, the drive will fault on loss of communications. If not in fieldbus control, place will not fault. 1 = In all control modes - no matter the control place setting. If communication is lost, fieldbus fault response will occur.			
Description:	Defines the fieldbus fault condition for BACnet MSTP communication.			
P11.3.8	MSTP maximum master			ID 1537
Minimum value:	1	Maximum value:	127	Default value: 127
Description:	Defines the maximum number of masters that can establish connections with the drive.			
P11.5 - SWD.				
P11.5.1	Parameter access			ID 2630
Minimum value:	N.A.	Maximum value:	N.A.	Default value: 1
Options:	0 = No permission to read/write on acyclic channel. 1 = Acyclic read/write are allowed on Profibus.			
Description:	PNU927 which specifies the operation priority of parameters for acyclic communication.			
P11.5.2^①	Parameter data access			ID 2631
Minimum value:	N.A.	Maximum value:	N.A.	Default value: 4
Options:	0 = Local control; 1 = Fieldbus; 2 = Mixed interface; 4 = NET, local on fault; or 5 = Dual mode.			
Description:	PNU928 which specifies the control priority of the device for cyclic communication.			

Table 32. Serial communication (Cont.).

P11.5.3	Fault situation counter			ID 2632
Minimum value:	N.A.	Maximum value:	N.A.	Default value: N.A.
Description:	PNU952 which specifies the fault situation counter. Only write of 0 is allowed, then the whole fault buffer (actual fault situation and all other fault situations) and the fault message counter (parameter 944) are erased.			
P11.5.4	Board status			ID 2609
Minimum value:	N.A.	Maximum value:	N.A.	Default value: 0
Description:	Status of the board. B0-DCOM communication fault. B1-Board HW fault B2-IO1 24 volt overload fault. B3-Profibus communication fault. B4-fieldbus fault.			
P11.5.5	Firmware version			ID 2610
Minimum value:	N.A.	Maximum value:	N.A.	Default value: N.A.
Description:	This parameter provides the firmware version of the SWD.			
P11.5.6	Protocol status			ID 2612
Minimum value:	N.A.	Maximum value:	N.A.	Default value: 0
Options:	0 = Not configured; 1 = Operational; or 2 = Diagnostics.			
Description:	This parameter specifies the protocol status for SWD card.			
P11.6 - Bluetooth.				
P11.6.1	Bluetooth enabled			ID 1895
Minimum value:	N.A.	Maximum value:	N.A.	Default value: 0
Options:	0 = Disabled; or 1 = Enabled.			
Description:	Bluetooth enabled.			
P11.6.2^②	Bluetooth broadcast mode			ID 2920
Minimum value:	N.A.	Maximum value:	N.A.	Default value: 0
Options:	0 = Off; or 1 = On.			
Description:	Bluetooth broadcast mode.			
P11.6.3	Bluetooth pairing reset			ID 2935
Minimum value:	N.A.	Maximum value:	N.A.	Default value: N.A.
Options:	0 = Not reset; or 1 = Reset.			
Description:	Bluetooth pairing reset.			

^① Parameter value can only be changed after the drive has stopped.

^② Parameter value will be set to be default when changing macros.

Table 33. Ethernet communication.

P12.1 - Basic settings.				
P12.1.1^①	IP address mode			ID 1500
Minimum value:	N.A.	Maximum value:	N.A.	Default value: 0
Options:	0 = Static IP; or 1 = DHCP with AutoIP.			
Description:	This parameter defined the IP address configuration mode for EIP/modbus TCP.			

Table 33. Ethernet communication (Cont.).

P12.1.2	Active IP address			ID 1507
Minimum value:	N.A.	Maximum value:	N.A.	Default value: N.A.
Description:	Reads the current active IP address.			
P12.1.3	Active subnet mask			ID 1509
Minimum value:	N.A.	Maximum value:	N.A.	Default value: N.A.
Description:	Reads the current active subnet mask.			
P12.1.4	Active default gateway			ID 1511
Minimum value:	N.A.	Maximum value:	N.A.	Default value: N.A.
Description:	Reads the current active default gateway.			
P12.1.5	MAC address			ID 1513
Minimum value:	N.A.	Maximum value:	N.A.	Default value: N.A.
Description:	Reads the current MAC address.			
P12.1.6^①	Static IP address			ID 1501
Minimum value:	N.A.	Maximum value:	N.A.	Default value: 192.168.1.254
Description:	Defines the static IP address.			
P12.1.7^①	Static subnet mask			ID 1503
Minimum value:	N.A.	Maximum value:	N.A.	Default value: 255.255.255.0
Description:	Defines the static subnet mask.			
P12.1.8^①	Static default gateway			ID 1505
Minimum value:	N.A.	Maximum value:	N.A.	Default value: 192.168.1.1
Description:	Defines the static default gateway.			
P12.1.9	Ethernet communication timeout			ID 611
Minimum value:	0 ms	Maximum value:	60,000 ms	Default value: 10,000 ms
Description:	Selects the time it waits before a communication fault occurs over ethernet.			
P12.2 - Trusted IP filter (DM1 PRO only).				
P12.2.1	Trusted IP white list			ID 68
Minimum value:	N.A.	Maximum value:	N.A.	Default value: 0.0.0.0 0.0.0.0 192.168.1.254
Description:	Defines the IP addresses in the white list. A setting of 192.168.1.255 enables all connections on the local subnet.			
P12.2.2	Trusted IP filter enable			ID 76
Minimum value:	N.A.	Maximum value:	N.A.	Default value: 1
Options:	0 = Disabled; or 1 = Enabled.			
Description:	Enables IP white listing. Devices not in the white list will not be able to establish communications with the drive.			
P12.3 - Modbus TCP (DM1 PRO only).				
P12.3.1^①	Modbus TCP enable			ID 1942
Minimum value:	N.A.	Maximum value:	N.A.	Default value: 0
Options:	0 = Disable; or 1 = Enable.			
Description:	Enables modbus TCP communications, must be enabled to connect to Power Xpert inControl.			
P12.3.2	Modbus TCP connection limit			ID 609
Minimum value:	N.A.	Maximum value:	N.A.	Default value: 5
Description:	Maximum number of connections allowed to the drive.			

Table 33. Ethernet communication (Cont.).

P12.3.3	Modbus TCP unit identifier number			ID 610
Minimum value:	N.A.	Maximum value:	N.A.	Default value: 1
Description:	Unit identifier unit value for modbus TCP.			
P12.3.4	Modbus TCP protocol status			ID 612
Minimum value:	N.A.	Maximum value:	N.A.	Default value: N.A.
Options:	0 = Stopped; 1 = Operational; or 2 = Faulted.			
Description:	This parameter shows the protocol status for modbus TCP communication.			
P12.3.5	Modbus TCP fault response			ID 2517
Minimum value:	N.A.	Maximum value:	N.A.	Default value: 0
Options:	0 = Only in fieldbus control mode - when fieldbus is the control place and fieldbus fault is active, the drive will fault on loss of communications. If not in fieldbus control, place will not fault. 1 = In all control modes - no matter the control place setting, if communication is lost, fieldbus fault response will occur.			
Description:	Defines the fieldbus fault condition for modbus TCP communication.			
P12.4 - Ethernet IP (DM1 PRO only).				
P12.4.1^①	Ethernet based protocol select			ID 1997
Minimum value:	N.A.	Maximum value:	N.A.	Default value: 0
Options:	0 = Disabled; or 2 = BACnet IP.			
Description:	Selects the active communication protocol on the ethernet I/P port.			
P12.4.2	Ethernet IP protocol status			ID 608
Minimum value:	N.A.	Maximum value:	N.A.	Default value: N.A.
Options:	0 = Off; 1 = Operational; or 2 = Faulted.			
Description:	Indicates if ethernet protocol is active or not.			
P12.4.3	Ethernet IP fault response			ID 2518
Minimum value:	N.A.	Maximum value:	N.A.	Default value: 0
Options:	0 = Only in fieldbus control mode - when fieldbus is the control place and Fieldbus fault is active, the drive will fault on loss of communications. If not in fieldbus control, place will not fault. 1 = In all control modes - no matter the control place setting. If communication is lost, fieldbus fault response will occur.			
Description:	Defines the fieldbus fault condition for ethernet IP communication.			

Table 33. Ethernet communication (Cont.).

P12.5 - BACnet IP (DM1 PRO only).				
P12.5.1^①	BACnet IP UDP port number			ID 1733
Minimum value:	N.A.	Maximum value:	N.A.	Default value: 47,808
Options:	47808 = BAC0; 47809 = BAC1; 47810 = BAC2; 47811 = BAC3; 47812 = BAC4; 47813 = BAC5; 47814 = BAC6; 47815 = BAC7; 47816 = BAC8; 47817 = BAC9; 47818 = BACA; 47819 = BACB; 47820 = BACC; 47821 = BACD; 47822 = BACE; or 47823 = BACF.			
Description:	Defines the BACnet UDP port number.			
P12.5.2^①	BACnet IP foreign devise			ID 1734
Minimum value:	N.A.	Maximum value:	N.A.	Default value: 0
Options:	0 = Disabled; or 1 = Enabled.			
Description:	Enables BACNET IP foreign device configuration.			
P12.5.3^①	BACnet IP BBMD IP			ID 1735
Minimum value:	N.A.	Maximum value:	N.A.	Default value: 0.0.0.0
Description:	Displays the BACnet BBMD IP address.			
P12.5.4^①	BACnet IP UDP port			ID 1737
Minimum value:	N.A.	Maximum value:	N.A.	Default value: 47,808
Options:	47808 = BAC0; 47809 = BAC1; 47810 = BAC2; 47811 = BAC3; 47812 = BAC4; 47813 = BAC5; 47814 = BAC6; 47815 = BAC7; 47816 = BAC8; 47817 = BAC9; 47818 = BACA; 47819 = BACB; 47820 = BACC; 47821 = BACD; 47822 = BACE; or 47823 = BACF.			
Description:	Displays the BACnet BBMD UDP port number.			
P12.5.5^①	BACnet IP registration interval			ID 1738
Minimum value:	0	Maximum value:	65,535	Default value: 10
Description:	Defines the registration interval.			
P12.5.6	BACnet IP communication timeout			ID 1739
Minimum value:	0	Maximum value:	60,000	Default value: 0
Description:	Selects the time it waits before a communication fault occurs over BACnet IP.			

Table 33. Ethernet communication (Cont.).

P12.5.7	BACnet IP protocol status			ID 1740
Minimum value:	N.A.	Maximum value:	N.A.	Default value: 0
Options:	0 = Stopped; 1 = Operational; or 2 = Faulted.			
Description:	This parameter shows the protocol status for BACnet IP communication.			
P12.5.8	BACnet IP fault behavior			ID 1741
Minimum value:	N.A.	Maximum value:	N.A.	Default value: 0
Options:	0 = Only in fieldbus control mode - when fieldbus is the control place and Fieldbus fault is active, the drive will fault on loss of communications. If not in fieldbus control, place will not fault. 1 = In all control modes - no matter the control place setting. If communication is lost, fieldbus fault response will occur.			
Description:	Defines the fieldbus fault condition for BACnet IP communication.			
P12.5.9^①	BACnet IP instance number			ID 1742
Minimum value:	0	Maximum value:	4,194,302	Default value: 0
Description:	Displays the BACnet instance number.			
P12.6 - Web UI (DM1 PRO only).				
P12.6.1	Web UI protocol status			ID 2915
Minimum value:	N.A.	Maximum value:	N.A.	Default value: N.A.
Options:	0 = Off; 1 = Operational; or 2 = Faulted.			
Description:	This parameter shows the protocol status for web server communication.			
P12.6.2	Web UI fault response			ID 2916
Minimum value:	N.A.	Maximum value:	N.A.	Default value: 0
Options:	0 = Only in fieldbus control mode - when fieldbus is the control place and fieldbus fault is active, the drive will fault on loss of communications. If not in fieldbus control, place will not fault. 1 = In all control modes - no matter the control place setting. If communication is lost, fieldbus fault response will occur.			
Description:	Defines the fieldbus fault condition for web server communication.			
P12.6.3	Web UI communication timeout			ID 2919
Minimum value:	30,000 ms	Maximum value:	60,000 ms	Default value: 60,000 ms
Description:	Selects the time it waits before a communication fault occurs over the web server.			
P12.6.4^①	Web UI enable			ID 2921
Minimum value:	N.A.	Maximum value:	N.A.	Default value: 0
Options:	0 = Disabled; or 1 = Enabled.			
Description:	Enables web server configuration and monitoring page.			

^① Parameter value can only be changed after the drive has stopped.

Table 34. System.

P13.1.1	Language			ID 340
Minimum value:	N.A.	Maximum value:	N.A.	Default value: 0
Options:	0 = English; 1 = English; or 2 = English.			
Description:	This parameter offers the ability to control the frequency converter through the keypad in the language of your choice. Currently available language is English only.			

Table 34. System (Cont.).

P13.1.2^①	Application			ID 142
Minimum value:	N.A.	Maximum value:	N.A.	Default value: N.A.
Options:	0 = Standard;; 1 = Pump; 2 = Fan; or 3 = Multi-purpose.			
Description:	This parameter sets the active application if multiple applications have been loaded.			
P13.1.3^①	Parameter sets			ID 619
Minimum value:	N.A.	Maximum value:	N.A.	Default value: N.A.
Options:	0 = No; 1 = Reload defaults; 2 = Reload set 1; 3 = Reload set 2; 4 = Store set 1; 5 = Store set 2; 6 = Reset; or 7 = Reload defaults VM.			
Description:	This parameter allows you to reload the factory default parameter values, and to store and load two customized parameter sets.			
P13.1.4	Up to keypad			ID 620
Minimum value:	N.A.	Maximum value:	N.A.	Default value: N.A.
Options:	0 = No; or 1 = Yes (all parameters).			
Description:	This function uploads all existing parameter groups to the keypad.			
P13.1.5^①	Down from keypad			ID 621
Minimum value:	N.A.	Maximum value:	N.A.	Default value: N.A.
Options:	0 = No; 1 = All parameters; 2 = All, no motor; or 3 = Application parameters.			
Description:	This function downloads one or all parameter groups from the keypad to the drive.			
P13.1.7	Parameter lock PIN			ID 624
Minimum value:	0	Maximum value:	9,999	Default value: 0
Description:	<p>The application selection can be protected against unauthorized changes with the password function. When the password function is enabled, the user will be prompted to enter a password before application changes, parameter value changes, or password changes.</p> <p>By default, the password function is not in use. If you want to activate the password, change the value of this parameter to any number between 1 and 9,999.</p> <p>To deactivate the password, reset the parameter value to 0.</p>			
P13.1.8	Keypad parameter lock			ID 625
Minimum value:	N.A.	Maximum value:	N.A.	Default value: 0
Options:	0 = Change enable; or 1 = Change disable.			
Description:	<p>This function allows the user to prohibit changes to the parameters. If the parameter lock is activated, the text “locked” will appear on the display if you try to edit a parameter value.</p> <p>Note: This function does not prevent unauthorized editing of parameter values.</p>			

Table 34. System (Cont.).

P13.1.9	Start-up Wizard			ID 626
Minimum value:	N.A.	Maximum value:	N.A.	Default value: 0
Options:	0 = Enabled. 1 = Disabled.			
Description:	The Start-up Wizard facilitates commissioning the DM1 PRO. If selected "Enable", the Start-up Wizard prompts the operator for the application desired and then advances parameters through the start-up parameter list/Application Mini wizard in keypad. After completion, it allows the user to go to the main menu or default page and this parameter is set to "Disabled". The Start-up Wizard is always enabled for the initial power up of the DM1 PRO. By setting this parameter to "Disable" without going through the Start-up Wizard, it will not cause it to be active on start-up. If user goes into Start-up Wizard after completion, or defaults drive, the Start-up Wizard will be "Enabled".			
P13.2 - Keypad.				
P13.2.4	Timeout time			ID 629
Minimum value:	1 s	Maximum value:	65,535 s.	Default value: 30 s
Description:	The timeout time setting defines the time after which the keypad display returns to the Default Page. Note: If the default page value is 0, the timeout time setting has no effect.			
P13.2.5	Contrast adjust			ID 630
Minimum value:	5	Maximum value:	18	Default value: 12
Description:	If the remote keypad display is not clear, you can adjust the keypad contrast with this parameter.			
P13.2.6	Backlight time			ID 631
Minimum value:	1 min.	Maximum value:	65,535 min.	Default value: 10 min.
Description:	This parameter determines how long the backlight stays on before going out.			
P13.2.7	Fan control			ID 632
Minimum value:	N.A.	Maximum value:	N.A.	Default value: 2
Options:	0 = Continuous - fan runs continuously. 1 = Temperature - based on the temperature of the unit. The fan is switched on automatically when the heat sink temperature reaches 60°C (140°F). The fan receives a stop command when the heat sink temperature falls to 55°C (131°F). The fan runs for about a minute after receiving the stop command or switching on the power, as well as after changing the value from "Continuous" to "Temperature". 2 = Run follow - after power up, the fan is stopped until the run command is given and then fan runs continuously. This is mainly made for common DC-bus systems to prevent cooling fans to load charging resistors on power up moment.			
Description:	This function allows you to control the DM1 PRO's cooling fan.			
P13.4 - Version information.				
P13.4.1	Keypad software version			ID 640
Minimum value:	N.A.	Maximum value:	N.A.	Default value: N.A.
Description:	Keypad firmware version.			
P13.4.2	Motor control software version			ID 642
Minimum value:	N.A.	Maximum value:	N.A.	Default value: N.A.
Description:	DSP/motor control software version.			
P13.4.3	Application software version			ID 644
Minimum value:	N.A.	Maximum value:	N.A.	Default value: N.A.
Description:	MCU/application software version.			
P13.4.4	Software bundle version			ID 1714
Minimum value:	N.A.	Maximum value:	N.A.	Default value: N.A.
Description:	Software bundle version.			

Table 34. System (Cont.).

P13.5 - Application information.				
P13.5.1	Serial number			ID 648
Minimum value:	N.A.	Maximum value:	N.A.	Default value: N.A.
Description:	Product serial number.			
P13.5.2	Multi-monitor set			ID 627
Minimum value:	N.A.	Maximum value:	N.A.	Default value: 0
Options:	0 = Change enable; or 1 = Change disable.			
Description:	The keypad display can display three actual monitored values at the same time. This parameter determines if the operator is allowed to replace the values monitored with other values.			
P13.5.3	Keypad lock PIN			ID 75
Minimum value:	0	Maximum value:	9,999	Default value: 0
Description:	<p>The keypad can be protected against unauthorized changes with the keypad lock function after keys are not pressed five minutes. When the password function is enabled, the user will be prompted to enter a password before the keypad display parameter or response to key press except up/down/left/right.</p> <p>By default, the password function is not in use. If you want to activate the password, change the value of this parameter to any number between 1 and 9,999.</p> <p>To deactivate the password, reset the parameter value to 0.</p>			
P13.5.4	Drive application name			ID 2922
Minimum value:	N.A.	Maximum value:	N.A.	Default value: N.A.
Description:	Drive application name.			

Ⓒ Parameter value can only be changed after the drive has stopped.

Chapter 6 - Pump control application

Introduction

The pump application builds on the features included in standard. In addition to all of the features in the standard application, the pump application provides features specific for pumping applications and pump related protective features.

Fan application includes functions:

- Pump derag mode;
- Valve control;
- Backspin control;
- Minimum run time;
- Separate minimum frequency ramp time;
- Multi-pump control;
- Pipe fill mode;
- Loss of prime detection; and
- Broken pipe detection.

I/O controls

“Function to terminal” (FTT) programming

The design behind programming of the digital inputs and outs of the DM1 uses “function to terminal” programming. It is composed of a terminal, be it a relay output or a digital output, that is assigned a parameter. Within that parameter, it has different functions that can be set.

Chapter 6 - Pump control application

Control I/O configuration

- Run 240 Vac and 24 Vdc control wiring in separate conduit.
- Communication wire to be shielded.

Table 35. Multi-Pump application default I/O connection.

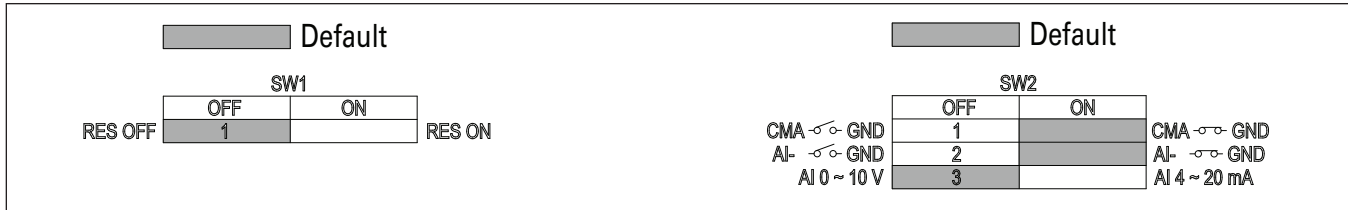

External wiring	Terminal	Short name	Name	Default setting	Description
	1	DI1	Digital input 1	Run forward	Starts the motor in the forward direction.
	2	DI2	Digital input 2	Run reverse	Start the motor in the reverse direction.
	3	DI3	Digital input 3	External fault	Triggers a fault in the drive.
	4	DI4	Digital input 4	Fault reset	Resets active faults in the drive.
	5	CMA	DI1 to DI4 common	Grounded	Allows for sourced input.
	6	A	RS-485 signal A	—	Fieldbus communication (Modbus RTU, BACNet).
	7	B	RS-485 signal B	—	Fieldbus communication (Modbus RTU, BACNet).
	8	AI1+ ⊕	Analog input 1	0 - 10 V	Voltage speed reference (programmable to 4 mA to 20 mA).
	9	AI1-	Analog input 1 ground	—	Analog input 1 common (ground).
	10	GND	I/O signal ground	—	I/O ground for reference and control.
	11	AO1+	Analog output 1	Output frequency	Shows output frequency to motor 0 - 60 Hz (4 mA to 20 mA).
	12	GND	I/O signal ground	—	I/O ground for reference and control.
	13	10 V	10 Vdc reference output	10.3 Vdc +/- 3%	10 Vdc reference voltage.
	14	24 V	24 Vdc control output	24 Vdc In/Out	Control voltage input/output (100 mA max.).
	15	STO_com	Safe torque common	—	Safe torque Off common.
	16	STO2	Safe torque Off 2	—	Safe torque Off 2 input.
	17	STO1	Safe torque Off 1	—	Safe torque Off 1 input.
	18	R1NO	Relay 1 normally open	Run	Changes state when the drive is in the run state.
	19	R1CM	Relay 1 common		
	20	R1NC	Relay 1 normally closed		
	21	R2NO	Relay 2 normally open	Fault	Changes state when the drive is in the fault state.
	22	R2CM	Relay 2 common		

Notes:

The above wiring demonstrates a SINK configuration. It is important that CMA is wired to ground (as shown by dashed line). If a SOURCE configuration is desired, wire 24 V to CMA and close the inputs to ground. When using the +10 V for AI1, it is important to wire AI1- to ground (as shown by dashed line). If using +10 V for AI1, terminals 9 and 10 need to be jumpered together.

Ⓢ AI1+ support 10 K potentiometer.

Pump application - parameters list

On the next pages you will find the lists of parameters within the respective parameter groups. Each parameter section within the table lists:

- Parameter code (location indication on the keypad; shows the operator the present parameter number);
- Parameter name;
- ID (number of the parameter);

and where applicable:

- Minimum value and units;
- Maximum value and units;
- Default value and units;
- Options (when available); and
- Description of the parameter.

Table 36. Monitor.

M1 - standard.				
M1.1	Output frequency			ID 1
Minimum value:	Hz	Maximum value:	Hz	Default value: Hz
Description:	Output frequency (Hz).			
M1.2	Frequency reference			ID 24
Minimum value:	Hz	Maximum value:	Hz	Default value: Hz
Description:	Reference frequency (Hz).			
M1.3	Motor speed			ID 2
Minimum value:	rpm	Maximum value:	rpm	Default value: rpm
Description:	Motor output speed (rpm).			
M1.4	Motor current			ID 3
Minimum value:	A	Maximum value:	A	Default value: A
Description:	Motor output current RMS (Amps).			
M1.5	Motor torque			ID 4
Minimum value:	%	Maximum value:	%	Default value: %
Description:	Percent motor torque calculated from nameplate values and measured motor current (%).			
M1.6	Motor power			ID 5
Minimum value:	%	Maximum value:	%	Default value: %
Description:	Percent motor power calculated from nameplate values and measured motor current (%).			
M1.7	Motor voltage			ID 6
Minimum value:	V	Maximum value:	V	Default value: V
Description:	Output ac motor voltage (Vac).			
M1.8	DC-link voltage			ID 7
Minimum value:	V	Maximum value:	V	Default value: V
Description:	DC bus voltage (Vdc).			

Chapter 6 - Pump control application

Table 36. Monitor (Cont.).

M1.9	Unit temperature			ID 8
Minimum value:	°C	Maximum value:	°C	Default value: °C
Description:	Heat sink temperature (deg. C).			
M1 - standard (Cont.).				
M1.10	Motor temperature			ID 9
Minimum value:	%	Maximum value:	%	Default value: %
Description:	Motor temperature value calculated from nameplate values and measured motor current (%).			
M1.11	Latest fault code			ID 28
Minimum value:	N.A.	Maximum value:	N.A.	Default value: N.A.
Description:	Last active fault code value. See fault codes for the value shown here.			
M1.12	Instant motor power			ID 1686
Minimum value:	kW	Maximum value:	kW	Default value: kW
Description:	Instantaneous motor power (kW).			
M2 - I/O status.				
M2.1	Analog input 1			ID 10
Minimum value:	Varies	Maximum value:	Varies	Default value: Varies
Description:	Analog input 1 measured value (Vdc or Amps) selectable with dipswitch.			
M2.2	Keypad pot voltage			ID 1858
Minimum value:	V	Maximum value:	V	Default value: V
Description:	Keypad potentiometer measured value (Vdc). DM1 PRO only.			
M2.3	Analog output			ID 25
Minimum value:	Varies	Maximum value:	Varies	Default value: Varies
Description:	Analog output 1 measured value (Vdc or Amps) selectable with parameter.			
M2.4	DI1, DI2, DI3			ID 12
Minimum value:	N.A.	Maximum value:	N.A.	Default value: N.A.
Description:	Digital input 1/2/3 status.			
M2.5	DI4			ID 13
Minimum value:	N.A.	Maximum value:	N.A.	Default value: N.A.
Description:	Digital input 4 status.			
M2.8	RO1, RO2			ID 557
Minimum value:	N.A.	Maximum value:	N.A.	Default value: N.A.
Description:	Relay output 1 and 2 status.			
M5 - PI monitor.				
M5.1	PI setpoint			ID 16
Minimum value:	Varies	Maximum value:	Varies	Default value: Varies
Description:	PI setpoint in process units.			
M5.2	PI feedback			ID 18
Minimum value:	Varies	Maximum value:	Varies	Default value: Varies
Description:	PI feedback level in process units.			
M5.3	PI error value			ID 20
Minimum value:	Varies	Maximum value:	Varies	Default value: Varies
Description:	PI error in process units.			

Table 36. Monitor (Cont.).

M5.4	PI output				ID 22
Minimum value:	%	Maximum value:	%	Default value:	%
Description:	PI output.				
M5.5	PI status				ID 23
Minimum value:	N.A.	Maximum value:	N.A.	Default value:	N.A.
Options:	0 = Stopped; 1 = Running; or 2 = Sleep mode.				
Description:	PI status indication, indicates if drive is stopped, running in PI mode, or in PI sleep mode.				

Table 37. Multi-pump status.

M7.1 - Operation mode.					
M7.1.1	Drive 1				ID 2218
Minimum value:	N.A.	Maximum value:	N.A.	Default value:	N.A.
Options:	0 = Offline; 1 = Slave drive; or 2 = Master drive.				
Description:	Provides the operating mode of drive 1 while using multi-pump mode.				
M7.1.2	Drive 2				ID 2230
Minimum value:	N.A.	Maximum value:	N.A.	Default value:	N.A.
Options:	0 = Offline; 1 = Slave drive; or 2 = Master drive.				
Description:	Provides the operating mode of drive 2 while using multi-pump mode.				
M7.1.3	Drive 3				ID 2242
Minimum value:	N.A.	Maximum value:	N.A.	Default value:	N.A.
Options:	0 = Offline; 1 = Slave drive; or 2 = Master drive.				
Description:	Provides the operating mode of drive 3 while using multi-pump mode.				
M7.1.4	Drive 4				ID 2254
Minimum value:	N.A.	Maximum value:	N.A.	Default value:	N.A.
Options:	0 = Offline; 1 = Slave drive; or 2 = Master drive.				
Description:	Provides the operating mode of drive 4 while using multi-pump mode.				
M7.1.5	Drive 5				ID 2266
Minimum value:	N.A.	Maximum value:	N.A.	Default value:	N.A.
Options:	0 = Offline; 1 = Slave drive; or 2 = Master drive.				
Description:	Provides the operating mode of drive 5 while using multi-pump mode.				

Table 37. Multi-pump status (Cont.).

M7.2 - Multi-pump status.				
M7.2.1	Drive 1			ID 2219
Minimum value:	N.A.	Maximum value:	N.A.	Default value: 5
Options:	0 = Stopped; 1 = Sleep; 2 = Regulating; 3 = Wait for CMD 4 = Following; or 5 = Unknown.			
Description:	Provides the run status of drive 1 while using the multi-pump mode.			
M7.2.2	Drive 2			ID 2231
Minimum value:	N.A.	Maximum value:	N.A.	Default value: 5
Options:	0 = Stopped; 1 = Sleep; 2 = Regulating; 3 = Wait for CMD 4 = Following; or 5 = Unknown.			
Description:	Provides the run status of drive 2 while using the multi-pump mode.			
M7.2.3	Drive 3			ID 2243
Minimum value:	N.A.	Maximum value:	N.A.	Default value: 5
Options:	0 = Stopped; 1 = Sleep; 2 = Regulating; 3 = Wait for CMD 4 = Following; or 5 = Unknown.			
Description:	Provides the run status of drive 3 while using the multi-pump mode.			
M7.2.4	Drive 4			ID 2255
Minimum value:	N.A.	Maximum value:	N.A.	Default value: 5
Options:	0 = Stopped; 1 = Sleep; 2 = Regulating; 3 = Wait for CMD 4 = Following; or 5 = Unknown.			
Description:	Provides the run status of drive 4 while using the multi-pump mode.			
M7.2.5	Drive 5			ID 2267
Minimum value:	N.A.	Maximum value:	N.A.	Default value: 5
Options:	0 = Stopped; 1 = Sleep; 2 = Regulating; 3 = Wait for CMD 4 = Following; or 5 = Unknown.			
Description:	Provides the run status of drive 5 while using the multi-pump mode.			
M7.3 - Network status.				
M7.3.1	Drive 1			ID 2220
Minimum value:	N.A.	Maximum value:	N.A.	Default value: N.A.
Options:	0 = Disconnected; 1 = Fault; 2 = Pump lost; 3 = Need alternation; or 4 = No error.			
Description:	Provides the network status of drive 1 while using the multi-pump mode.			

Table 37. Multi-pump status (Cont.).

M7.3.2	Drive 2				ID 2232
Minimum value:	N.A.	Maximum value:	N.A.	Default value:	N.A.
Options:	0 = Disconnected; 1 = Fault; 2 = Pump lost; 3 = Need alternation; or 4 = No error.				
Description:	Provides the network status of drive 2 while using the multi-pump mode.				
M7.3.3	Drive 3				ID 2244
Minimum value:	N.A.	Maximum value:	N.A.	Default value:	N.A.
Options:	0 = Disconnected; 1 = Fault; 2 = Pump lost; 3 = Need alternation; or 4 = No error.				
Description:	Provides the network status of drive 3 while using the multi-pump mode.				
M7.3.4	Drive 4				ID 2256
Minimum value:	N.A.	Maximum value:	N.A.	Default value:	N.A.
Options:	0 = Disconnected; 1 = Fault; 2 = Pump lost; 3 = Need alternation; or 4 = No error.				
Description:	Provides the network status of drive 4 while using the multi-pump mode.				
M7.3.5	Drive 5				ID 2268
Minimum value:	N.A.	Maximum value:	N.A.	Default value:	N.A.
Options:	0 = Disconnected; 1 = Fault; 2 = Pump lost; 3 = Need alternation; or 4 = No error.				
Description:	Provides the network status of drive 5 while using the multi-pump mode.				

Table 38. Multi-pump measurement.

M8.1 - Latest fault code.					
M8.1.1	Drive 1				ID 2221
Minimum value:		Maximum value:		Default value:	
Description:	Provides the latest fault code of drive 1 while using the multi-pump mode.				
M8.1.2	Drive 2				ID 2233
Minimum value:		Maximum value:		Default value:	
Description:	Provides the latest fault code of drive 2 while using the multi-pump mode.				
M8.1.3	Drive 3				ID 2245
Minimum value:		Maximum value:		Default value:	
Description:	Provides the latest fault code of drive 3 while using the multi-pump mode.				
M8.1.4	Drive 4				ID 2257
Minimum value:		Maximum value:		Default value:	
Description:	Provides the latest fault code of drive 4 while using the multi-pump mode.				
M8.1.5	Drive 5				ID 2269
Minimum value:		Maximum value:		Default value:	
Description:	Provides the latest fault code of drive 5 while using the multi-pump mode.				

Table 38. Multi-pump measurement (Cont.).

M8.2 - Output frequency.				
M8.2.1	Drive 1			ID 2222
Minimum value:	Hz	Maximum value:	Hz	Default value: Hz
Description:	Provides the output frequency (Hz) of drive 1 while using the multi-pump mode.			
M8.2.2	Drive 2			ID 2234
Minimum value:	Hz	Maximum value:	Hz	Default value: Hz
Description:	Provides the output frequency (Hz) of drive 2 while using the multi-pump mode.			
M8.2.3	Drive 3			ID 2246
Minimum value:	Hz	Maximum value:	Hz	Default value: Hz
Description:	Provides the output frequency (Hz) of drive 3 while using the multi-pump mode.			
M8.2.4	Drive 4			ID 2258
Minimum value:	Hz	Maximum value:	Hz	Default value: Hz
Description:	Provides the output frequency (Hz) of drive 4 while using the multi-pump mode.			
M8.2.5	Drive 5			ID 2270
Minimum value:	Hz	Maximum value:	Hz	Default value: Hz
Description:	Provides the output frequency (Hz) of drive 5 while using the multi-pump mode.			
M8.3 - Motor voltage.				
M8.3.1	Drive 1			ID 2223
Minimum value:	V	Maximum value:	V	Default value: V
Description:	Provides the motor voltage (Vac) of drive 1 while using the multi-pump mode.			
M8.3.2	Drive 2			ID 2235
Minimum value:	V	Maximum value:	V	Default value: V
Description:	Provides the motor voltage (Vac) of drive 2 while using the multi-pump mode.			
M8.3.3	Drive 3			ID 2247
Minimum value:	V	Maximum value:	V	Default value: V
Description:	Provides the motor voltage (Vac) of drive 3 while using the multi-pump mode.			
M8.3.4	Drive 4			ID 2259
Minimum value:	V	Maximum value:	V	Default value: V
Description:	Provides the motor voltage (Vac) of drive 4 while using the multi-pump mode.			
M8.3.5	Drive 5			ID 2271
Minimum value:	V	Maximum value:	V	Default value: V
Description:	Provides the motor voltage (Vac) of drive 5 while using the multi-pump mode.			
M8.4 - Motor current.				
M8.4.1	Drive 1			ID 2224
Minimum value:	A	Maximum value:	A	Default value: A
Description:	Provides the motor current (Amps) of drive 1 while using the multi-pump mode.			
M8.4.2	Drive 2			ID 2236
Minimum value:	A	Maximum value:	A	Default value: A
Description:	Provides the motor current (Amps) of drive 2 while using the multi-pump mode.			
M8.4.3	Drive 3			ID 2248
Minimum value:	A	Maximum value:	A	Default value: A
Description:	Provides the motor current (Amps) of drive 3 while using the multi-pump mode.			

Table 38. Multi-pump measurement (Cont.).

M8.4.4	Drive 4			ID 2260
Minimum value:	A	Maximum value:	A	Default value: A
Description:	Provides the motor current (Amps) of drive 4 while using the multi-pump mode.			
M8.4.5	Drive 5			ID 2272
Minimum value:	A	Maximum value:	A	Default value: A
Description:	Provides the motor current (Amps) of drive 5 while using the multi-pump mode.			
M8.5 - Motor torque.				
M8.5.1	Drive 1			ID 2225
Minimum value:	%	Maximum value:	%	Default value: %
Description:	Provides the motor torque (%) of drive 1 while using the multi-pump mode.			
M8.5.2	Drive 2			ID 2237
Minimum value:	%	Maximum value:	%	Default value: %
Description:	Provides the motor torque (%) of drive 2 while using the multi-pump mode.			
M8.5.3	Drive 3			ID 2249
Minimum value:	%	Maximum value:	%	Default value: %
Description:	Provides the motor torque (%) of drive 3 while using the multi-pump mode.			
M8.5.4	Drive 4			ID 2261
Minimum value:	%	Maximum value:	%	Default value: %
Description:	Provides the motor torque (%) of drive 4 while using the multi-pump mode.			
M8.5.5	Drive 5			ID 2273
Minimum value:	%	Maximum value:	%	Default value: %
Description:	Provides the motor torque (%) of drive 5 while using the multi-pump mode.			
M8.6 - Motor power.				
M8.6.1	Drive 1			ID 2226
Minimum value:	%	Maximum value:	%	Default value: %
Description:	Provides the motor power (%) of drive 1 while using the multi-pump mode.			
M8.6.2	Drive 2			ID 2238
Minimum value:	%	Maximum value:	%	Default value: %
Description:	Provides the motor power (%) of drive 2 while using the multi-pump mode.			
M8.6.3	Drive 3			ID 2250
Minimum value:	%	Maximum value:	%	Default value: %
Description:	Provides the motor power (%) of drive 3 while using the multi-pump mode.			
M8.6.4	Drive 4			ID 2262
Minimum value:	%	Maximum value:	%	Default value: %
Description:	Provides the motor power (%) of drive 4 while using the multi-pump mode.			
M8.6.5	Drive 5			ID 2274
Minimum value:	%	Maximum value:	%	Default value: %
Description:	Provides the motor power (%) of drive 5 while using the multi-pump mode.			
M8.7 - Motor speed.				
M8.7.1	Drive 1			ID 2227
Minimum value:	rpm	Maximum value:	rpm	Default value: rpm
Description:	Provides the motor speed (rpm) of drive 1 while using the multi-pump mode.			

Table 38. Multi-pump measurement (Cont.).

M8.7.2	Drive 2			ID 2239
Minimum value:	rpm	Maximum value:	rpm	Default value: rpm
Description:	Provides the motor speed (rpm) of drive 2 while using the multi-pump mode.			
M8.7.3	Drive 3			ID 2251
Minimum value:	rpm	Maximum value:	rpm	Default value: rpm
Description:	Provides the motor speed (rpm) of drive 3 while using the multi-pump mode.			
M8.7.4	Drive 4			ID 2263
Minimum value:	rpm	Maximum value:	rpm	Default value: rpm
Description:	Provides the motor speed (rpm) of drive 4 while using the multi-pump mode.			
M8.7.5	Drive 5			ID 2275
Minimum value:	rpm	Maximum value:	rpm	Default value: rpm
Description:	Provides the motor speed (rpm) of drive 5 while using the multi-pump mode.			
M8.8 - Run time.				
M8.8.1	Drive 1			ID 2228
Minimum value:	Hours	Maximum value:	Hours	Default value: Hours
Description:	Provides the motor run time (h) of drive 1 while using the multi-pump mode.			
M8.8.2	Drive 2			ID 2240
Minimum value:	Hours	Maximum value:	Hours	Default value: Hours
Description:	Provides the motor run time (h) of drive 2 while using the multi-pump mode.			
M8.8.3	Drive 3			ID 2252
Minimum value:	Hours	Maximum value:	Hours	Default value: Hours
Description:	Provides the motor run time (h) of drive 3 while using the multi-pump mode.			
M8.8.4	Drive 4			ID 2264
Minimum value:	Hours	Maximum value:	Hours	Default value: Hours
Description:	Provides the motor run time (h) of drive 4 while using the multi-pump mode.			
M8.8.5	Drive 5			ID 2276
Minimum value:	Hours	Maximum value:	Hours	Default value: Hours
Description:	Provides the motor run time (h) of drive 5 while using the multi-pump mode.			
M9 - Multi-monitoring.				
M9.1	Multi-monitoring			ID 30
Minimum value:	N.A.	Maximum value:	N.A.	Default value: 0, 1, 2.
Description:	Displays any three monitoring values in a single screen. The values are selectable via the keypad menu. Multi-monitor page could see three lines of monitoring values. Up and down keys can be used to select the row and then hitting the left arrow key will allow for editing the value then by going up and down.			

Table 39. Parameters.

P1 - Basic parameters.				
P1.1^②	Minimum frequency			ID 101
Minimum value:	0.00 Hz	Maximum value:	400.00 Hz	Default value: 0.00 Hz
Description:	Defines the lowest frequency at which the drive will operate. This setting will limit other frequency parameter settings. 1 = Fire mode minimum frequency. 2 = Derag. 3 = MPFC staging frequency. 4 = MPFC master fixed frequency. 5 = Prime pump frequency. 6 = Prime pump frequency 2.			
P1.2^②	Maximum frequency			ID 102
Minimum value:	0.00 Hz	Maximum value:	400.00 Hz	Default value: MaxFreqMFG
Description:	Defines the highest frequency at which the drive will operate. This will limit other frequency parameters. 1 = Keypad reference. 2 = Motor potentiometer. 3 = Jog speed. 4 = 2nd stage ramp frequency. 5 = Fire mode minimum frequency. 6 = Derag. 7 = MPFC staging frequency. 8 = MPFC master fixed frequency. 9 = Prime pump frequency. 10 = Prime pump frequency 2. 11 = Preset speed frequency. 12 = Frequency limit value. 13 = Reference limit value. 14 = Speed control_fs2. 15 = Stall frequency limit. 16 = 4 mA fault frequency. 17 = MPFC de-staging frequency. 18 = Pipe fill loss frequency low. 19 = Pipe fill loss frequency high. 20 = Broken pipe frequency limit.			
P1.3^②	Accel. time 1			ID 103
Minimum value:	0.1 s	Maximum value:	3,000.0 s	Default value: 20.0 s
Description:	Defines the time required for the output frequency to accelerate from zero frequency to maximum frequency.			
P1.4^②	Decel. time 1			ID 104
Minimum value:	0.1 s	Maximum value:	3,000.0 s	Default value: 20.0 s
Description:	Defines the time required for the output frequency to decelerate from maximum frequency to zero frequency.			
P1.6^①	Motor nom. current			ID 486
Minimum value:	DriveNomCurrCT*1/10 A	Maximum value:	DriveNomCurrCT*2 A	Default value: DriveNomCurrCT A
Description:	Motor nameplate rated full load current. This value is found on the rating plate of the motor.			
P1.7^①	Motor nom. speed			ID 489
Minimum value:	300 rpm	Maximum value:	20,000 rpm	Default value: MotorNomSpeedMFG
Description:	Motor nameplate rated speed. This value is found on the rating plate of the motor.			
P1.8^①	Motor PF			ID 490
Minimum value:	0.30	Maximum value:	1.00	Default value: 0.85
Description:	Motor nameplate rated power factor. This value is found on the rating plate of the motor.			
P1.9^①	Motor nom. voltage			ID 487
Minimum value:	180 V	Maximum value:	690 V	Default value: MotorNomVoltMFG V
Description:	Motor nameplate rated voltage. This value is found on the rating plate of the motor.			
P1.10^①	Motor nom. frequency			ID 488
Minimum value:	8.00 Hz	Maximum value:	400.00 Hz	Default value: MotorNomFreqMFG Hz
Description:	Motor nameplate rated frequency. This value is found on the rating plate of the motor.			

Chapter 6 - Pump control application

Table 39. Parameters (Cont.).

P1.11 ^②	Local control place			ID 1695
Minimum value:	N.A.	Maximum value:	N.A.	Default value: 0
Options:	0 = keypad; 1 = I/O terminal; or 3 = fieldbus.			
Description:	Defines the signal location for the start command in local mode. I/O terminals would be from the digital hard-wired inputs or keypad for Start/Stop buttons on the drive. Keypad display will indicate which mode is selected.			
P1.12 ^{①②}	Local reference			ID 136
Minimum value:	N.A.	Maximum value:	N.A.	Default value: 1
Options:	0 = AI; 1 = drive ref. pot; 4 = maximum frequency; 6 = keypad; or 7 = fieldbus ref.			
Description:	Defines the signal location for the speed reference in local mode.			
P1.13 ^②	Remote control place			ID 135
Minimum value:	N.A.	Maximum value:	N.A.	Default value: 0
Options:	0 = I/O terminal; 1 = fieldbus; or 3 = keypad.			
Description:	Defines the signal location for the start command in remote mode. I/O terminals would be from the digital hard-wired inputs or keypad for Start/Stop buttons on the drive. Keypad display will indicate which mode is selected.			
P1.14 ^{①②}	Remote reference			ID 137
Minimum value:	N.A.	Maximum value:	N.A.	Default value: 0
Options:	0 = AI; 1 = drive reference pot; 4 = maximum frequency; 6 = keypad; or 7 = fieldbus reference.			
Description:	Defines the signal location for the speed reference in remote mode.			

Table 40. Inputs.

P2.1 - Basic settings.				
P2.1.1 ^②	AI reference scale minimum value			ID 144
Minimum value:	0.00 Hz	Maximum value:	RefScaleMax Hz	Default value: 0.00 Hz
Description:	Defines the minimum frequency associated with 0% input from the analog input. Setting AI reference scale minimum value and AI reference scale maximum value both to zero will cause the analog input to scale to the minimum and maximum frequencies.			
P2.1.2 ^②	AI reference scale maximum value			ID 145
Minimum value:	RefScaleMin Hz	Maximum value:	400.00 Hz	Default value: 0.00 Hz
Description:	Defines the maximum frequency associated with 100% input from the analog input. Setting AI reference scale minimum value and AI reference scale maximum value both to zero will cause the analog input to scale to the minimum and maximum frequencies.			

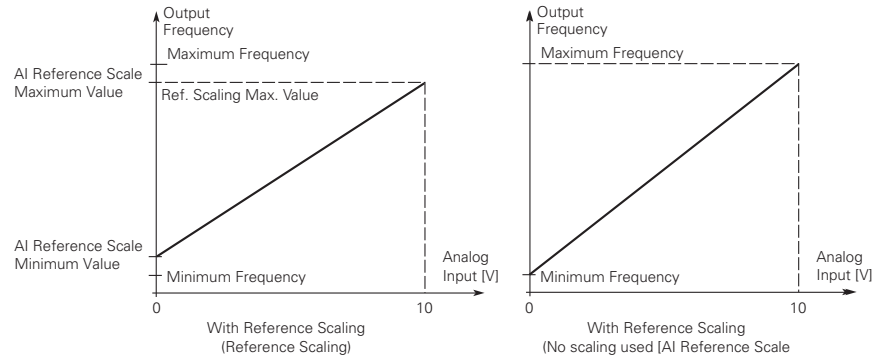

P2.1.3 ^{①②}	IO terminal Start/Stop logic			ID 143
Minimum value:	N.A.	Maximum value:	N.A.	Default value: 0
Options:	0 = Forward - reverse: maintained input on start signal 1 to run forward and a maintained signal on start signal 2 for reverse. 1 = Start - reverse: maintained input on start signal 1 to run forward and a maintained signal on start signal 2 for reverse. 2 = Start - enable: maintained input on start signal 1 to run forward and a maintained signal on start signal 2 to enable the drive to run. 3 = Start pulse - stop pulse: used for three-wire operation, start signal 1 uses a normally open start and start signal 2 uses a normally closed stop.			
Description:	Defines the functionality for start signal 1 and start signal 2. By default, start signal 1 is DI1 and start signal 2 is DI2. 0 = P3.2: IO terminal start signal 1 = start forward - P3.3: IO terminal start signal 2 = start reverse. This would be considered 2-wire control with either a contact used on the start FWD or start REV commands. When contacts open, the motor stops.			

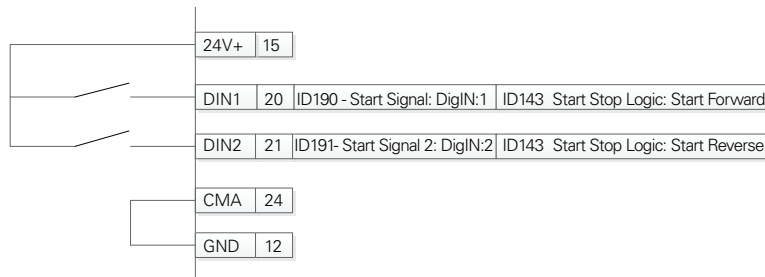
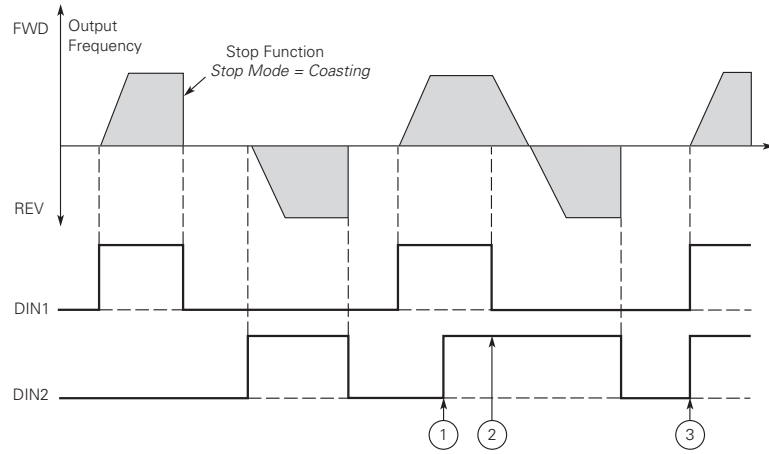

Table 40. Inputs (Cont.).



- Notes:**
- ① The first selected direction has the highest priority.
 - ② When the DIN1 contact opens the direction of rotation starts to change.
 - ③ If start forward (DIN1) and start reverse (DIN2) signals are active simultaneously the start forward signal (DIN1) has priority.

1 = P3.2: IO terminal start signal 1 = start forward - P3.3: IO terminal start signal 2 = start reverse. This would be considered 2-wire control with a contact on start/stop, contact open it stops and direction on 2nd start signal.

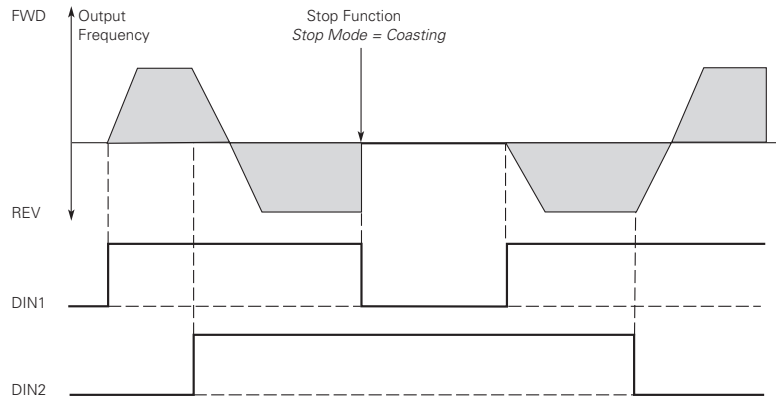
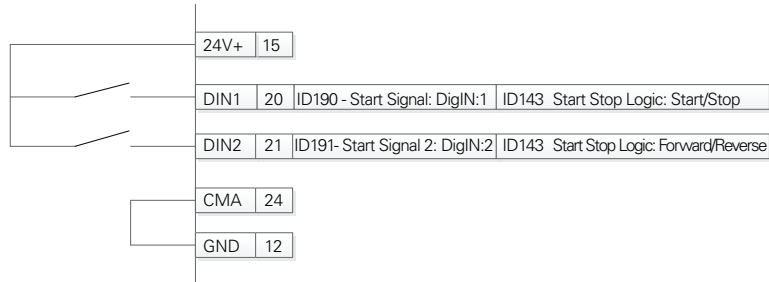
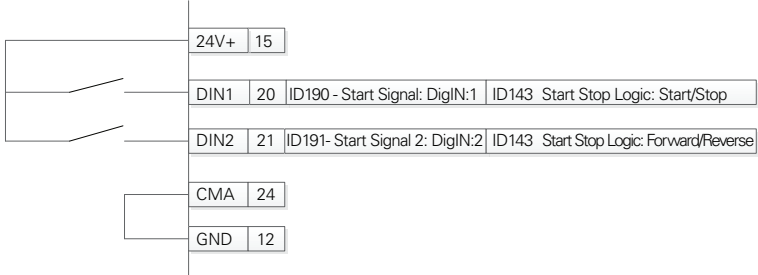

Table 40. Inputs (Cont.).

2 = P3.2: DI closed contact = start/open contact = stop P3.3: IO terminal start signal 1 = start forward - P3.3: IO terminal start signal 2 = start reverse. This would be considered 3-wire control with start signal 2 required to be closed to enable start on start signal 1.



3 = Three-wire connection (pulse control): P3.2: IO terminal start signal 1 = start forward - P3.3: IO terminal start signal 2 = start reverse. This would be considered 3-wire control with start signal 1 being the start pulse and start signal 2 being the NC stop.

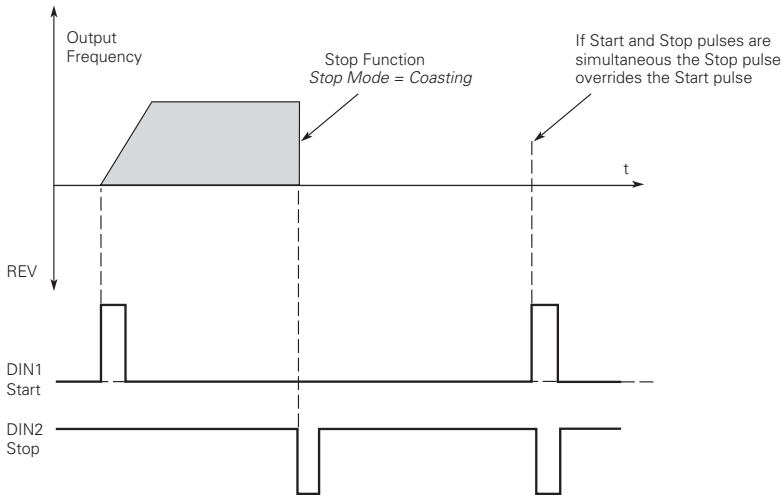
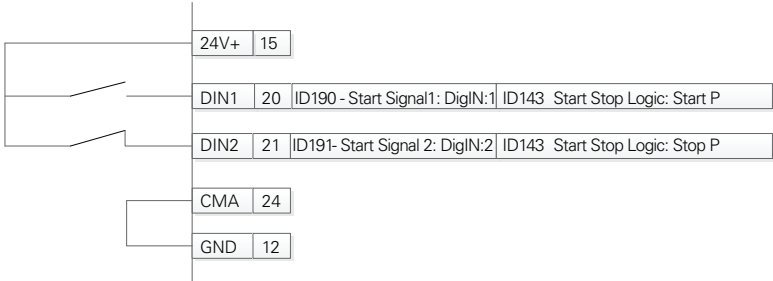

Table 40. Inputs (Cont.).

P2.2 - Digital input.					
P2.2.1[Ⓢ]	D11 function				ID 1801
Minimum value:	N.A.	Maximum value:	N.A.	Default value:	1
Options:	0 = Not Used, no action; 1 = IO terminal start signal 1 - when the control source is set to IO terminal this input when closed will perform the action defined by P2.1.3; 2 = IO terminal start signal 2 - when the control source is set to IO terminal this input when closed will perform the action defined by P2.1.3; 3 = Reverse - when start/stop logic is set to 3 start pulse stop pulse, this input will cause the drive to start in the reverse direction; 4 = Ext. fault 1 - when closed, ext. fault 1 will be activated; 5 = Ext. fault 2 - when closed, ext. fault 2 will be activated; 6 = Ext. fault 3 - when closed, ext. fault 3 will be activated; 7 = Fault reset - when closed, all active faults will be reset; 8 = Run enable - when closed, the drive will allow a start command and be in the ready state; 9 = Preset speed B0 - the 7 preset speeds are selected via 3 binary inputs, this is least significant bit in that binary input; 10 = Preset speed B1 - the 7 preset speeds are selected via 3 binary inputs; 11 = Preset speed B2 - the 7 preset speeds are selected via 3 binary inputs, this is most significant bit in that binary input; 12 = Jog enable - when closed, the jog speed defined at P2.3.8 will override the frequency reference; 13 = Accel. pot value - when closed, the motor potentiometer value will increment at the rate defined by motor pot ramp time; 14 = Decel. pot value - when closed, the motor potentiometer value will decrement at the rate defined by motor pot ramp time; 15 = Reset pot zero - when closed, the motor potentiometer value will reset to zero; 16 = Accel./decel. time set - when open, accel./decel. time 1 will be used ; when closed accel./decel. time 2 will be used; 17 = Accel./decel. prohibit - when closed, the drive will hold the output frequency and ignore changes to the reference value; 18 = No access to parameters - when closed, no changes can be made to any setting in the drive; 19 = Remote control - when closed, the drive will be forced to the remote control place; 20 = Local control - when closed, the drive will be forced to the Local control place; 21 = Parameter 1/2 sel. - when open, parameter set 1 is active: when closed parameter set 2 is active; 22 = PI controller - when closed, the drive will force the reference source to PI controller output; 23 = PI set point select - when open, parameter set point 1 is active: when closed, set point 2 is active; 24 = Motor interlock 1 - when closed, motor will be enabled to run; 25 = Smoke mode - when closed, smoke mode will be active; 26 = Fire mode - when closed, fire mode will be active; 27 = Fire mode reference 1/2 sel. - when fire mode is active and this input is open, fire mode reference 1 will be active: when closed, fire mode reference 2 will be active; 28 = Fire mode reverse - when fire mode is active and this input is open, direction will be forward: when closed, reverse; 29 = DC brake active - when closed, DC injection braking will be active; 30 = Preheat active - when closed, preheat mode will be active; or 31 = Derag. enable - when closed, the Derag. cycle for pumps will be initiated.				
Description:	Defines the function of digital input 1.				

Table 40. Inputs (Cont.).

P2.2.3 [®]	D12 function	ID 1803
Minimum value:	N.A.	Maximum value: N.A. Default value: 2
Options:	0 = Not Used, no action; 1 = IO terminal start signal 1 - when the control source is set to IO terminal this input when closed will perform the action defined by P2.1.3; 2 = IO terminal start signal 2 - when the control source is set to IO terminal this input when closed will perform the action defined by P2.1.3; 3 = Reverse - when start/stop logic is set to 3 start pulse stop pulse, this input will cause the drive to start in the reverse direction; 4 = Ext. fault 1 - when closed, ext. fault 1 will be activated; 5 = Ext. fault 2 - when closed, ext. fault 2 will be activated; 6 = Ext. fault 3 - when closed, ext. fault 3 will be activated; 7 = Fault reset - when closed, all active faults will be reset; 8 = Run enable - when closed, the drive will allow a start command and be in the ready state; 9 = Preset speed B0 - the 7 preset speeds are selected via 3 binary inputs, this is least significant bit in that binary input; 10 = Preset speed B1 - the 7 preset speeds are selected via 3 binary inputs; 11 = Preset speed B2 - the 7 preset speeds are selected via 3 binary inputs, this is most significant bit in that binary input; 12 = Jog enable - when closed, the jog speed defined at P2.3.8 will override the frequency reference; 13 = Accel. pot value - when closed, the motor potentiometer value will increment at the rate defined by motor pot ramp time; 14 = Decel. pot value - when closed, the motor potentiometer value will decrement at the rate defined by motor pot ramp time; 15 = Reset pot zero - when closed, the motor potentiometer value will reset to zero; 16 = Accel./decel. time set - when open, accel./decel. time 1 will be used ; when closed accel./decel. time 2 will be used; 17 = Accel./decel. prohibit - when closed, the drive will hold the output frequency and ignore changes to the reference value; 18 = No access to parameters - when closed, no changes can be made to any setting in the drive; 19 = Remote control - when closed, the drive will be forced to the remote control place; 20 = Local control - when closed, the drive will be forced to the Local control place; 21 = Parameter 1/2 sel. - when open, parameter set 1 is active: when closed parameter set 2 is active; 22 = PI controller - when closed, the drive will force the reference source to PI controller output; 23 = PI set point select - when open, parameter set point 1 is active: when closed, set point 2 is active; 24 = Motor interlock 1 - when closed, motor will be enabled to run; 25 = Smoke mode - when closed, smoke mode will be active; 26 = Fire mode - when closed, fire mode will be active; 27 = Fire mode reference 1/2 sel. - when fire mode is active and this input is open, fire mode reference 1 will be active: when closed, fire mode reference 2 will be active; 28 = Fire mode reverse - when fire mode is active and this input is open, direction will be forward: when closed, reverse; 29 = DC brake active - when closed, DC injection braking will be active; 30 = Preheat active - when closed, preheat mode will be active; or 31 = Derag. enable - when closed, the Derag. cycle for pumps will be initiated.	
Description:	Defines the function of digital input 2.	

Chapter 6 - Pump control application

Table 40. Inputs (Cont.).

P2.2.5^②	D13 function	ID 1805
Minimum value:	N.A.	Maximum value: N.A. Default value: 4
Options:	0 = Not Used, no action; 1 = IO terminal start signal 1 - when the control source is set to IO terminal this input when closed will perform the action defined by P2.1.3; 2 = IO terminal start signal 2 - when the control source is set to IO terminal this input when closed will perform the action defined by P2.1.3; 3 = Reverse - when start/stop logic is set to 3 start pulse stop pulse, this input will cause the drive to start in the reverse direction; 4 = Ext. fault 1 - when closed, ext. fault 1 will be activated; 5 = Ext. fault 2 - when closed, ext. fault 2 will be activated; 6 = Ext. fault 3 - when closed, ext. fault 3 will be activated; 7 = Fault reset - when closed, all active faults will be reset; 8 = Run enable - when closed, the drive will allow a start command and be in the ready state; 9 = Preset speed B0 - the 7 preset speeds are selected via 3 binary inputs, this is least significant bit in that binary input; 10 = Preset speed B1 - the 7 preset speeds are selected via 3 binary inputs; 11 = Preset speed B2 - the 7 preset speeds are selected via 3 binary inputs, this is most significant bit in that binary input; 12 = Jog enable - when closed, the jog speed defined at P2.3.8 will override the frequency reference; 13 = Accel. pot value - when closed, the motor potentiometer value will increment at the rate defined by motor pot ramp time; 14 = Decel. pot value - when closed, the motor potentiometer value will decrement at the rate defined by motor pot ramp time; 15 = Reset pot zero - when closed, the motor potentiometer value will reset to zero; 16 = Accel./decel. time set - when open, accel./decel. time 1 will be used ; when closed accel./decel. time 2 will be used; 17 = Accel./decel. prohibit - when closed, the drive will hold the output frequency and ignore changes to the reference value; 18 = No access to parameters - when closed, no changes can be made to any setting in the drive; 19 = Remote control - when closed, the drive will be forced to the remote control place; 20 = Local control - when closed, the drive will be forced to the Local control place; 21 = Parameter 1/2 sel. - when open, parameter set 1 is active: when closed parameter set 2 is active; 22 = PI controller - when closed, the drive will force the reference source to PI controller output; 23 = PI set point select - when open, parameter set point 1 is active: when closed, set point 2 is active; 24 = Motor interlock 1 - when closed, motor will be enabled to run; 25 = Smoke mode - when closed, smoke mode will be active; 26 = Fire mode - when closed, fire mode will be active; 27 = Fire mode reference 1/2 sel. - when fire mode is active and this input is open, fire mode reference 1 will be active: when closed, fire mode reference 2 will be active; 28 = Fire mode reverse - when fire mode is active and this input is open, direction will be forward: when closed, reverse; 29 = DC brake active - when closed, DC injection braking will be active; 30 = Preheat active - when closed, preheat mode will be active; or 31 = Derag. enable - when closed, the Derag. cycle for pumps will be initiated.	
Description:	Defines the function of digital input 3.	

Table 40. Inputs (Cont.).

P2.2.7[Ⓢ]	DI4 function			ID 1807
Minimum value:	N.A.	Maximum value:	N.A.	Default value: 7
Options:	0 = Not Used, no action; 1 = IO terminal start signal 1 - when the control source is set to IO terminal this input when closed will perform the action defined by P2.1.3; 2 = IO terminal start signal 2 - when the control source is set to IO terminal this input when closed will perform the action defined by P2.1.3; 3 = Reverse - when start/stop logic is set to 3 start pulse stop pulse, this input will cause the drive to start in the reverse direction; 4 = Ext. fault 1 - when closed, ext. fault 1 will be activated; 5 = Ext. fault 2 - when closed, ext. fault 2 will be activated; 6 = Ext. fault 3 - when closed, ext. fault 3 will be activated; 7 = Fault reset - when closed, all active faults will be reset; 8 = Run enable - when closed, the drive will allow a start command and be in the ready state; 9 = Preset speed B0 - the 7 preset speeds are selected via 3 binary inputs, this is least significant bit in that binary input; 10 = Preset speed B1 - the 7 preset speeds are selected via 3 binary inputs; 11 = Preset speed B2 - the 7 preset speeds are selected via 3 binary inputs, this is most significant bit in that binary input; 12 = Jog enable - when closed, the jog speed defined at P2.3.8 will override the frequency reference; 13 = Accel. pot value - when closed, the motor potentiometer value will increment at the rate defined by motor pot ramp time; 14 = Decel. pot value - when closed, the motor potentiometer value will decrement at the rate defined by motor pot ramp time; 15 = Reset pot zero - when closed, the motor potentiometer value will reset to zero; 16 = Accel./decel. time set - when open, accel./decel. time 1 will be used ; when closed accel./decel. time 2 will be used; 17 = Accel./decel. prohibit - when closed, the drive will hold the output frequency and ignore changes to the reference value; 18 = No access to parameters - when closed, no changes can be made to any setting in the drive; 19 = Remote control - when closed, the drive will be forced to the remote control place; 20 = Local control - when closed, the drive will be forced to the Local control place; 21 = Parameter 1/2 sel. - when open, parameter set 1 is active: when closed parameter set 2 is active; 22 = PI controller - when closed, the drive will force the reference source to PI controller output; 23 = PI set point select - when open, parameter set point 1 is active: when closed, set point 2 is active; 24 = Motor interlock 1 - when closed, motor will be enabled to run; 25 = Smoke mode - when closed, smoke mode will be active; 26 = Fire mode - when closed, fire mode will be active; 27 = Fire mode reference 1/2 sel. - when fire mode is active and this input is open, fire mode reference 1 will be active: when closed, fire mode reference 2 will be active; 28 = Fire mode reverse - when fire mode is active and this input is open, direction will be forward: when closed, reverse; 29 = DC brake active - when closed, DC injection braking will be active; 30 = Preheat active - when closed, preheat mode will be active; or 31 = Derag. enable - when closed, the Derag. cycle for pumps will be initiated.			
Description:	Defines the function of digital input 4.			
P2.3 - Preset speed.	Preset speed 1			105
P2.3.1[Ⓢ]	Preset speed 1			ID 105
Minimum value:	0.00 Hz	Maximum value:	MaxFreq Hz	Default value: 5.00 Hz
Description:	Preset speed is selected with digital inputs using a binary input.			
P2.3.2[Ⓢ]	Preset speed 2			ID 106
Minimum value:	0.00 Hz	Maximum value:	MaxFreq Hz	Default value: 10.00 Hz
Description:	Preset speed is selected with digital inputs using a binary input.			
P2.3.3[Ⓢ]	Preset speed 3			ID 118
Minimum value:	0.00 Hz	Maximum value:	MaxFreq Hz	Default value: 15.00 Hz
Description:	Preset speed is selected with digital inputs using a binary input.			
P2.3.4[Ⓢ]	Preset speed 4			ID 119
Minimum value:	0.00 Hz	Maximum value:	MaxFreq Hz	Default value: 20.00 Hz
Description:	Preset speed is selected with digital inputs using a binary input.			
P2.3.5[Ⓢ]	Preset speed 5			ID 120
Minimum value:	0.00 Hz	Maximum value:	MaxFreq Hz	Default value: 25.00 Hz
Description:	Preset speed is selected with digital inputs using a binary input.			
P2.3.6[Ⓢ]	Preset speed 6			ID 121
Minimum value:	0.00 Hz	Maximum value:	MaxFreq Hz	Default value: 30.00 Hz
Description:	Preset speed is selected with digital inputs using a binary input.			

Table 40. Inputs (Cont.).

P2.3.7[®]	Preset speed 7			ID 122
Minimum value:	0.00 Hz	Maximum value:	MaxFreq Hz	Default value: 35.00 Hz
Description:	Preset speed is selected with digital inputs using a binary input.			

P2.4 - AI settings.

P2.4.1	AI mode			ID 222
Minimum value:	N.A.	Maximum value:	N.A.	Default value: 1
Options:	0 = 0 - 20 mA; or 1 = 0 - 10 V.			
Description:	<p>Defines the analog input mode to current or voltage the DIP switches on control board will need to be set to the same mode as this parameter.</p> <p>*DM1 PRO CN5 terminals 8 and 9 for current or voltage, also need to set DIP switches SW2 2 and 3 on control board, near the RJ45 port.</p> <p>DIP switches SW2 2 and 3 off for voltage.</p> <p>Current mode, if using the +10 V supply on CN5 terminals 13 of the DM1 / DM1 Pro, it will require DIP switches SW2 2 and 3 on to complete the current loop. When doing a current loop with an external supply, the DIP switches SW2 2 off and 3 on.</p>			

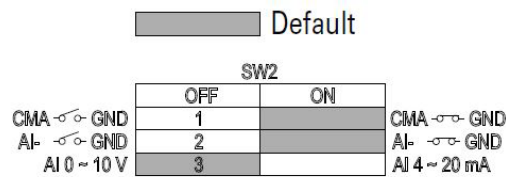
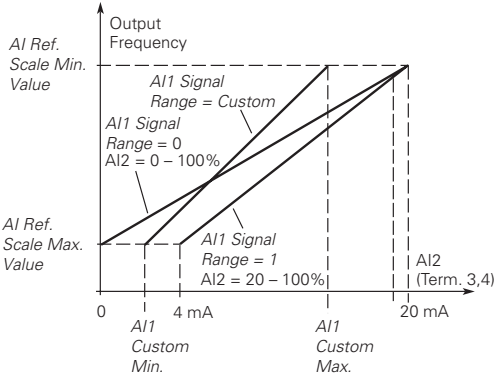

Table 40. Inputs (Cont.).

P2.4.2^②	AI signal range			ID 175
Minimum value:	N.A.	Maximum value:	N.A.	Default value: 0
Options:	0 = 0-100%/0-20 mA/0-10 V. 1 = 20-100%/4-20 mA/2-10 V.			
Description:	With this parameter, you can select the analog input 1 signal range. For selection "Customized," see "AI Custom Min" and "AI Custom Max", this enables a customized signal range.			



① Parameter value can only be changed after the drive has stopped.
② Parameter value will be set to be default when changing macros.

Table 41. Outputs .

P3.1 - Digital output.					
P3.1.1^②	RO1 function				ID 152
Minimum value:	N.A.	Maximum value:	N.A.	Default value:	2
Options:	0 = Not used - no action; 1 = Ready - drive is ready for operation; 2 = Run - drive is running; 3 = Fault - drive is faulted; 4 = Fault invert - drive is not faulted; 5 = Warning - drive has a warning message; 6 = Reverse - drive is outputting reverse phase rotation; 7 = At speed - drive output frequency has reached the set reference; 8 = Zero frequency - drive output is at zero frequency; 9 = Frequency limit supervision - supervision for frequency limit 1 is activated; 10 = PI supervision - supervision for PI controller is activated; 11 = Torque limit supervision - supervision for torque limit; 12 = Reference limit supervision - supervision for reference limit; 13 = Power limit supervision - supervision for power limit; 14 = Temperature limit supervision - supervision for drive temperature limit; 15 = Analog input supervision - supervision for analog input limit; 16 = Motor current supervision - supervision for motor current limit; 17 = Over heat fault - drive over heat fault has occurred; 18 = Over current regular - over current regulator is enabled; 19 = Over volt regular - over volt regulator is enabled; 20 = Under volt regular - under volt regulator is enabled; 21 = 4 mA fault - 4 mA fault has occurred; 22 = External fault - external fault has occurred; 23 = Motor thermal fault - motor thermal fault has occurred; 24 = STO fault output - safe torque Off input is activated; 25 = Control from IO - I/O is the selected start command location; 26 = Remote control - remote is the control place; 27 = Unrequested rotation direction - active direction is not the same as the reference direction; 28 = Fire mode - drive is in fire mode; 29 = Damper control - damper control output; 30 = Valve control - valve control output; 31 = Jog speed - drive is in jog mode; 32 = Fieldbus input 1 - controller by fieldbus control word; 33 = Fieldbus input 2 - controlled by fieldbus control word; 34 = DC charge switch close - DC pre-charge relay is closed; 35 = Preheat active - preheat control mode is activated; 36 = Cold weather active - cold weather mode is active ; 37 = PI sleep - PI controller is in a sleep state; 38 = 2nd stage ramp frequency active - Accel/Decel time 2 is active 39 = Prime pump active - drive is running in prime pump mode; 40 = Master drive state - indicates it is the master drive in the multi-pump control mode; 41 = Slave drive state - indicates it is the slave drive in the multi-pump control mode; or 43 = Single drive control - indicates the motor contactor is open or close in multi-pump control mode.				
Description:	Defines the function associated with changing the state of relay output 1.				

Table 41. Outputs (Cont.).

P3.1.4[Ⓢ]	RO2 function				ID 153
Minimum value:	N.A.	Maximum value:	N.A.	Default value:	3
Options:	0 = Not used - no action; 1 = Ready - drive is ready for operation; 2 = Run - drive is running; 3 = Fault - drive is faulted; 4 = Fault invert - drive is not faulted; 5 = Warning - drive has a warning message; 6 = Reverse - drive is outputting reverse phase rotation; 7 = At speed - drive output frequency has reached the set reference; 8 = Zero frequency - drive output is at zero frequency; 9 = Frequency limit supervision - supervision for frequency limit 1 is activated; 10 = PI supervision - supervision for PI controller is activated; 11 = Torque limit supervision - supervision for torque limit; 12 = Reference limit supervision - supervision for reference limit; 13 = Power limit supervision - supervision for power limit; 14 = Temperature limit supervision - supervision for drive temperature limit; 15 = Analog input supervision - supervision for analog input limit; 16 = Motor current supervision - supervision for motor current limit; 17 = Over heat fault - drive over heat fault has occurred; 18 = Over current regular - over current regulator is enabled; 19 = Over volt regular - over volt regulator is enabled; 20 = Under volt regular - under volt regulator is enabled; 21 = 4 mA fault - 4 mA fault has occurred; 22 = External fault - external fault has occurred; 23 = Motor thermal fault - motor thermal fault has occurred; 24 = STO fault output - safe torque Off input is activated; 25 = Control from IO - I/O is the selected start command location; 26 = Remote control - remote is the control place; 27 = Unrequested rotation direction - active direction is not the same as the reference direction; 28 = Fire mode - drive is in fire mode; 29 = Damper control - damper control output; 30 = Valve control - valve control output; 31 = Jog speed - drive is in jog mode; 32 = Fieldbus input 1 - controller by fieldbus control word; 33 = Fieldbus input 2 - controlled by fieldbus control word; 34 = DC charge switch close - DC pre-charge relay is closed; 35 = Preheat active - preheat control mode is activated; 36 = Cold weather active - cold weather mode is active ; 37 = PI sleep - PI controller is in a sleep state; 38 = 2nd stage ramp frequency active - Accel/Decel time 2 is active 39 = Prime pump active - drive is running in prime pump mode; 40 = Master drive state - indicates it is the master drive in the multi-pump control mode; 41 = Slave drive state - indicates it is the slave drive in the multi-pump control mode; or 43 = Single drive control - indicates the motor contactor is open or close in multi-pump control mode.				
Description:	Defines the function associated with changing the state of relay output 2.				
P3.3 - Analog output.					
P3.3.1[Ⓢ]	AO mode				ID 227
Minimum value:	N.A.	Maximum value:	N.A.	Default value:	0
Options:	0 = 0 - 20 mA; or 1 = 0 - 10 V.				
Description:	Defines the analog output mode to current or voltage.				

Chapter 6 - Pump control application

Table 41. Outputs (Cont.).

P3.3.2[ⓐ]	AO function			ID 146
Minimum value:	N.A.	Maximum value:	N.A.	Default value: 1
Options:	1 = Output frequency (0 - max frequency); 2 = Frequency reference (0 - max frequency); 3 = Motor speed RPM (0 - nameplate RPM); 4 = Motor current (0 - nameplate current); 5 = Motor torque (0 - calculated nominal); 6 = Motor power (0 - calculated nominal); 7 = Motor voltage (0 - nameplate voltage); 8 = DC bus voltage (0 - 1000 Vdc); 9 = PI setpoint (process unit minimum - process unit maximum); 10 = PI error value (process unit minimum - process unit maximum); 11 = PI output (process unit minimum - process unit maximum); 12 = Analog input (0% - 100%); 13 = Drive reference potentiometer (0% - 100%); 14 = Fieldbus process data input 1 (0% - 100%); 15 = Fieldbus process data input 2 (0% - 100%); 16 = Fieldbus process data input 3 (0% - 100%); 17 = Fieldbus process data input 4 (0% - 100%); 18 = Fieldbus process data input 5 (0% - 100%); 19 = Fieldbus process data input 6 (0% - 100%); 20 = Fieldbus process data input 7 (0% - 100%); 21 = Fieldbus process data input 8 (0% - 100%); 22 = User defined output (user defined minimum - user defined maximum); 23 = Motor torque (0% - 200%); or 24 = Motor power absolute value (0% - 100%).			
Description:	Select the function desired to the terminal AO1.			

[ⓐ] Parameter value will be set to be default when changing macros.

Table 42. Drive control.

P4.1 - Basic settings.				
P4.1.1[ⓐ]	Keypad reference			ID 141
Minimum value:	MinFreq	Maximum value:	MaxFreq	Default value: 0.00 Hz
Description:	Keypad reference value.			
P4.1.3[ⓐ]	Keypad stop			ID 114
Minimum value:	N.A.	Maximum value:	N.A.	Default value: 1
Options:	0 = Enabled - keypad operation - In this mode, the keypad stop will only operate when the control source is set to keypad. 1 = Always enabled - In this mode, the stop button will always stop the drive regardless of control mode.			
Description:	Enabled or always enabled keypad operation.			
P4.1.4[ⓐ]	Reverse enabled			ID 1679
Minimum value:	N.A.	Maximum value:	N.A.	Default value: 1
Options:	0 = Disabled; or 1 = Enabled.			
Description:	Enables or disables the reverse motor direction.			
P4.1.5	Change phase sequence motor			ID 2515
Minimum value:	N.A.	Maximum value:	N.A.	Default value: 0
Options:	0 = Change disable; or 1 = Change enable.			
Description:	This parameter allows for swapping the motor phase output from u, v, w to u, w, v.			

Table 42. Drive control (Cont.).

P4.1.6^②	Power up local remote select			ID 1685
Minimum value:	N.A.	Maximum value:	N.A.	Default value: 0
Options:	0 = Hold last; 1 = Local control; or 2 = Remote control.			
Description:	Selects what control place the drive will start at after power is applied. The default setting will hold the last state that the drive was in when powered down, selecting Local or Remote will cause the drive to start in that mode regardless of last state.			
P4.1.8^②	Start mode			ID 252
Minimum value:	N.A.	Maximum value:	N.A.	Default value: 0
Options:	0 = Ramp - The drive starts from 0 Hz and ramps to the frequency reference value. 1 = Flying start from stop frequency - The drive will catch a spinning motor. This setting searches for the current frequency using the last operating frequency as a starting point. 2 = Flying start from maximum frequency - The drive will catch a spinning motor. This setting searches for the current frequency using the maximum operating frequency as a starting point.			
Description:	Selects the start mode operation.			
P4.1.9^②	Stop mode			ID 253
Minimum value:	N.A.	Maximum value:	N.A.	Default value: 1
Options:	0 = Coasting - After a stop command, the motor coasts to a stop uncontrolled by the drive. 1 = Ramp - After the stop command, the speed of the motor is decelerated according to the set deceleration parameters.			
Description:	Selects the stop mode operation.			
P4.1.10^②	Ramp 1 shape			ID 247
Minimum value:	0.0 s	Maximum value:	10.0 s	Default value: 0.0 s
Description:	The start and end of the acceleration and deceleration ramps can be smoothed with these parameters. Setting a value of 0.00 seconds gives a linear ramp shape that causes acceleration and deceleration to react immediately to the changes in the reference signal. Setting a value from 0.10 to 10.00 seconds for this parameter produces an S-shaped acceleration/deceleration at the start and stop of the slope.			

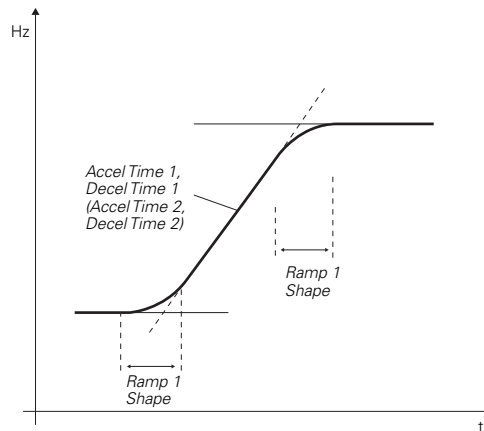

Table 42. Drive control (Cont.).

P4.1.11^②	Ramp 2 shape			ID 248
Minimum value:	0.0 s	Maximum value:	10.0 s	Default value: 0.0 s
Description:	<p>The start and end of the acceleration and deceleration ramps can be smoothed with these parameters. Setting a value of 0.00 gives a linear ramp shape that causes acceleration and deceleration to react immediately to the changes in the reference signal.</p> <p>Setting a value from 0.10 to 10.00 seconds for this parameter produces an S-shaped acceleration/deceleration at the start and stop of the slope.</p>			
P4.1.12^②	Accel. time 2			ID 249
Minimum value:	0.1 s	Maximum value:	3000.0 s	Default value: 10.0 s
Description:	<p>These values correspond to the time required for the output frequency to accelerate from the zero frequency to the set maximum frequency.</p> <p>These parameters provide the possibility to set two different acceleration/deceleration time sets for one application. The active set can be selected with the programmable digital input.</p>			
P4.1.13^②	Decel. time 2			ID 250
Minimum value:	0.1 s	Maximum value:	3000.0 s	Default value: 10.0 s
Description:	<p>These values correspond to the time required for the output frequency to decelerate from the set maximum frequency to the zero frequency.</p> <p>These parameters provide the possibility to set two different acceleration/deceleration time sets for one application. The active set can be selected with the programmable digital input.</p>			
P4.1.14^{①②}	2nd Stage ramp frequency			ID 2444
Minimum value:	MinFreq.	Maximum value:	MaxFreq.	Default value: 30.00 Hz
Description:	<p>When 2nd stage ramp frequency is the frequency level at which the drive will enable the 2nd stage ramp frequency output function. This then can be used for other inputs or devices to signal a frequency level.</p>			

① Parameter value can only be changed after the drive has stopped.

② Parameter value will be set to be default when changing macros.

Table 43. Motor control.

P5.1 - Basic settings.					
P5.1.1^{①②}	Motor control mode				ID 287
Minimum value:	N.A.	Maximum value:	N.A.	Default value:	0
Options:	0 = Frequency control - Output frequency is controlled directly by the frequency reference. 1 = Speed control - Output frequency is controlled by giving a frequency reference to it with slip compensation. 2 = Open loop vector control - Similar to the standard speed control mode, higher performance slip calculation requires running a motor identification. 3 = PM control 1 - PM motor control mode 1, used for SPM (surface mounted permanent magnet) and it also can be used for IPM. 4 = PM control 2 - PM motor control mode 2, used for IPM (internally mounted permanent magnet) and it can not be used for SPM.				
Description:	Selects the motor control mode.				
P5.1.2^①	Current limit				ID 107
Minimum value:	DriveNomCurrCT*1/10 A	Maximum value:	DriveNomCurrCT*2 A	Default value:	DriveNomCurrCT*3/2 A
Description:	This parameter determines the maximum output current allowed from the drive. The parameter value range differs from size to size. Once the motor current hits this level, it goes into the current limiter controller and tries to limit the output current.				
P5.1.3^{①②}	V/Hz optimization				ID 109
Minimum value:	N.A.	Maximum value:	N.A.	Default value:	0
Options:	0 = Disable torque boost function. 1 = Enable torque boost function.				
Description:	Automatic torque boost - the voltage to the motor increases automatically, which assists the motor to produce sufficient torque to start and run at low frequencies with high loads.				
P5.1.4^{①②}	V/Hz ratio				ID 108
Minimum value:	N.A.	Maximum value:	N.A.	Default value:	0
Options:	0 = Linear - the voltage of the motor changes linearly with the frequency in the constant flux area from 0 Hz to the field weakening point where the nominal voltage is supplied. A linear V/Hz ratio should be used in constant torque applications. 1 = Squared - the voltage of the motor changes following a squared curve with the frequency in the area from 0 Hz to the field weakening point where the nominal voltage is supplied. The motor runs under magnetized below the field weakening point and produces less torque and electromechanical noise. A squared V/Hz ratio can be used in applications where the torque demand of the load is proportional to the square of the speed. 2 = Programmable V/Hz curve - the V/Hz curve can be programmed with three different points. These points are the 0 frequency voltage, midpoint and weakening point. A programmable V/Hz curve can be used if the other settings do not satisfy the needs of the application. 3 = Linear with flux optimization - the drive starts to search for the minimum motor current in order to save energy. This mode is called Eaton's Active Energy Control which will reduce the voltage and current but still maintain the desired speed.				
Description:	Selects the V/Hz ratio. 0 = Linear; 1 = Squared; 2 = Programmable; or 3 = Linear + flux optimization.				
 <p style="text-align: center;">0 = Linear and 1 = Squared.</p>					
P5.1.10^②	Switching frequency				ID 288
Minimum value:	MinSwitchFreq kHz	Maximum value:	MaxSwitchFreq kHz	Default value:	DefaultSwitchFreqCT kHz
Description:	Sets the switching frequency for the PWM output waveform.				

Table 43. Motor control (Cont.).

P5.1.16^{①②}	Identification			ID 299
Minimum value:	N.A.	Maximum value:	N.A.	Default value: 0
Options:	0 = Not action. 1 = Identification only stator resistor - does not spin the motor. This can be done with load attached. 2 = Identification with run - motor stator resistor is completed then the motor is run. This must be completed with unloaded motor. 3 = Identification no run - motor is supplied with current and voltage but at zero frequency. 4 = Identification only inertia - identification for the system inertia only.			
Description:	This parameter enables the drive to make an motor identification cycle of the motor once complete the drive will adjust tuning parameters to improve starting torque and open loop vector control performance. Once set and a run command is given, the operation will be active then set back to 0 when completed. When a run command is issued, the message on the keypad will indicate "Auto tuning" is being performed. If there is an issue with the motor identification, a fault message will be displayed.			

① Parameter value can only be changed after the drive has stopped.

② Parameter value will be set to be default when changing macros.

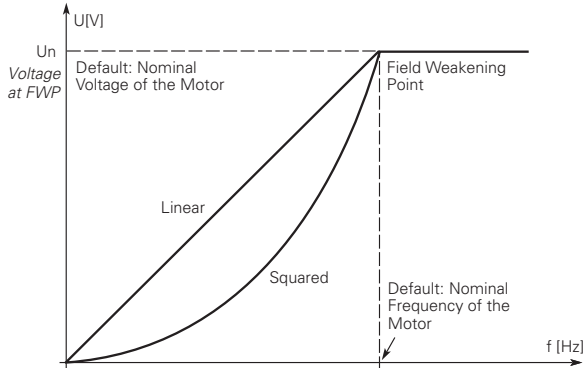
Table 44. Protections.

P6.1 - Motor.				
P6.1.4^{①②}	Motor thermal protection			ID 310
Minimum value:	N.A.	Maximum value:	N.A.	Default value: 2
Options:	0 = No response. 1 = Warning. 2 = Fault, stop mode after fault according to parameter stop mode. 3 = Fault, stop mode after fault always by coasting.			
Description:	If a fault condition is selected, the drive will stop and activate the fault stage based off the % of calculated motor temperature. The calculated motor temp is based off the install power on values of the drive and monitoring values as the drive is running. Deactivating this protection, i.e., setting parameter to 0, will reset the thermal stage of the motor to 0%.			
P6.1.5^②	Motor thermal FO current			ID 311
Minimum value:	0.00%	Maximum value:	150.00%	Default value: 100.00%
Description:	The current can be set between 0 - 150.0% x InMotor. This parameter sets the value for thermal current at zero frequency. The default value is set assuming that there is no external fan cooling the motor. If an external fan is used, this parameter can be set to 90% (or even higher).			
	<p>Note: The value is set as a percentage of the motor nameplate data, P1.6 (nominal current of the motor), not the drive's nominal output current. The motor's nominal current is the current that the motor can withstand in direct on-line use without being overheated. If you change the parameter nominal current of motor, this parameter is automatically restored to the default value. Setting this parameter does not affect the maximum output current of the drive.</p>			

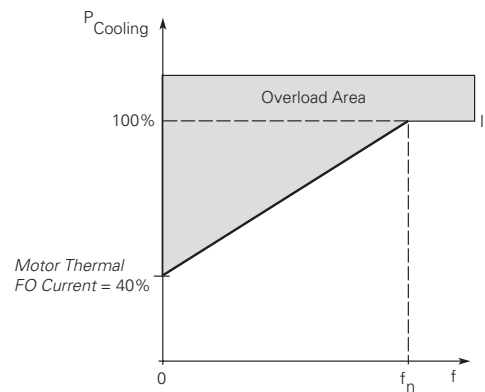

Table 44. Protections (Cont.).

P6.2 - Drive.					
P6.2.2^{①②}	Input phase fault				ID 332
Minimum value:	N.A.	Maximum value:	N.A.	Default value:	2
Options:	0 = No response; 1 = Warning; 2 = Fault, stop mode after fault according to parameter stop mode; 3 = Fault, stop mode after fault always by coasting; or 4 = Single phase power limit.				
Description:	The input phase supervision ensures that the input phases of the frequency converter have approximately equal current draw.				
P6.2.3^{①②}	4 mA input fault				ID 306
Minimum value:	N.A.	Maximum value:	N.A.	Default value:	0
Options:	0 = No response. 1 = Warning. 2 = Warning, the frequency from 10 seconds back is set as reference. 3 = Warning, the preset frequency P6.2.4 is set as reference. 4 = Fault, stop mode after fault according to parameter stop mode. 5 = Fault, stop mode after fault always by coasting.				
Description:	A warning or a fault action and message is generated if the 4 - 20 mA reference signal is used and the signal falls below 4 mA for 5 seconds, or below 0.5 mA for 0.5 seconds. The information can also be programmed into relay outputs R01 and R02.				
P6.2.4^{①②}	4 mA fault frequency				ID 331
Minimum value:	0.00 Hz	Maximum value:	MaxFreq Hz	Default value:	0.00
Description:	When 4 mA fault happens, the output frequency of drive goes to this preset speed when P6.2.3 = 3.				
P6.2.5^{①②}	External fault				ID 307
Minimum value:	N.A.	Maximum value:	N.A.	Default value:	2
Options:	0 = No action; 1 = Warning; 2 = Fault, stop mode after fault according to parameter stop mode. 3 = Fault, stop mode after fault always by coasting.				
Description:	A warning or a fault action and message is generated from the external fault signal in the programmable (digital inputs function select external fault). The status information can also be programmed into digital output relay outputs R01 and R02.				
P6.2.11^②	STO fault response				ID 2427
Minimum value:	N.A.	Maximum value:	N.A.	Default value:	2
Options:	0 = No Action - drive will stop, no indication shown, no reset required, have to cycle start command. 1 = Warning - drive indicate warning/if STO clears drive will run without reset. 2 = Fault - drive will indicate fault/require reset to start again.				
Description:	STO fault response defines the function of how the STO input will be seen on the keypad and how the drive functions to it.				
P6.2.12^①	PI feedback AI loss response				ID 2401
Minimum value:	N.A.	Maximum value:	N.A.	Default value:	0
Options:	0 = No action; 1 = Warning; 2 = Fault; or 3 = Warning: preset frequency (P6.2.13).				
Description:	This parameter defines the function of the PI feedback analog input loss response. If the AI feedback is lost based off the programed AI feedback.				
P6.2.13^{①②}	PI feedback AI loss pre-frequency				ID 2402
Minimum value:	0.00 Hz	Maximum value:	400.00 Hz	Default value:	0.00 Hz
Description:	This parameter defines the frequency the master would run to if a feedback is lost and P6.2.12 was set to option 3.				
P6.2.14^②	PI feedback AI loss pipe fill				ID 2403
Minimum value:	0.0 varies	Maximum value:	1000.0 varies	Default value:	0.0 varies
Description:	Detects loss of prime in the pump based off the measured level. If the value drops below this level for the time in P6.2.15 and below, the frequency in P6.2.13 "loss of prime" occurs.				

Chapter 6 - Pump control application

Table 44. Protections (Cont.).

P6.2.15 ^②	PI feedback AI loss pre-frequency timeout			ID 2404
Minimum value:	0.0 s	Maximum value:	6,000.0 s	Default value: 0.0 s
Description:	PI feedback AI loss pre-frequency timeout - when P6.2.12 is set to 3 or 4, when the feedback signal is lost, the drive will run at the frequency in P6.2.15 for the time set here. After this time, the drive will fault out on "feedback loss". The time is disabled when set to 0 seconds.			
P6.3 - Communications.				
P6.3.1 ^{①②}	Fieldbus fault response			ID 334
Minimum value:	N.A.	Maximum value:	N.A.	Default value: 2
Options:	0 = No action; 1 = Warning; 2 = Fault; or 3 = Fault, coast.			
Description:	This sets the response mode for the fieldbus fault when a fieldbus mode is used and communication is lost between the PLC and communication port. Each protocol has another parameter to select in all control or only in fieldbus control to set fault or warning.			
P6.3.2 ^{①②}	OPTcard fault response			ID 335
Minimum value:	N.A.	Maximum value:	N.A.	Default value: 2
Options:	0 = No action; 1 = Warning; 2 = Fault; or 3 = Fault, coast.			
Description:	This sets the response mode for a board slot fault caused by a missing or failed option board not communicating to the central processor.			

① Parameter value can only be changed after the drive has stopped.

② Parameter value will be set to be default when changing macros.

Table 45. PI Controller.

P7.1 - Basic settings.				
P7.1.1 ^②	PI control gain			ID 1294
Minimum value:	0.00%	Maximum value:	200.00%	Default value: 100.00%
Description:	Defines the gain of the PI Controller. It adjust the slope of the speed increase according to the initial of the load. If this value is set to 100%, a change of 10% in the error value causes the controller output to change 10%.			
P7.1.2 ^②	PI control itime			ID 1295
Minimum value:	0.00 s	Maximum value:	600.00 s	Default value: 1.00 s
Description:	Defines the integration time of the PI controller. Over the time, the integral time contributes to the deviation between the reference and the feedback signal. If this value is set to 1.00 sec., a change of 10% in the error value causes the controller output to change by 10.00%/s.			

Table 45. PI Controller (Cont.).

P7.1.3^{①②}	PI process unit			ID 1297
Minimum value:	N.A.	Maximum value:	N.A.	Default value: 0
Options:	0 = %; 1 = 1/min.; 2 = rpm; 3 = ppm; 4 = pps; 5 = l/s; 6 = l/min.; 7 = l/h; 8 = kg/s; 9 = kg/min.; 10 = kg/h; 11 = m ³ /s; 12 = m ³ /min.; 13 = m ³ /h; 14 = m/s; 15 = mbar; 16 = bar; 17 = Pa; 18 = kPa; 19 = mV/s; 20 = kW; 21 = Deg. C; 22 = GPM; 23 = gal/s; 24 = gal/min.; 25 = gal/h; 26 = lb/s; 27 = lb/min.; 28 = lb/h; 29 = CFM; 30 = ft ³ /s; 31 = ft ³ /min.; 32 = ft ³ /h; 33 = ft/s; 34 = in. wg; 35 = ft wg; 36 = PSI; 37 = lb/in.2; 38 = HP; 39 = Deg. F; 40 = PA; 41 = WC; 42 = HG; 43 = ft; 44 = m;			
Description:	Defines the unit type for PI feedback unit.			
P7.1.4^②	PI process unit minimum			ID 1298
Minimum value:	-99999.99 varies	Maximum value:	PI Process Unit Max	Default value: 0.00 varies
Description:	Defines the minimum process unit value.			
P7.1.5^②	PI process unit maximum			ID 1300
Minimum value:	PI Process Unit Min	Maximum value:	99999.99 varies	Default value: 100.00 varies
Description:	Defines the maximum process unit value.			
P7.1.6^{①②}	PI error inversion			ID 1303
Minimum value:	N.A.	Maximum value:	N.A.	Default value: 0
Options:	0 = Normal - if feedback is less than set-point, PI controller output increases. 1 = Inverted - if feedback is less than set-point, PI controller output decreases.			
Description:	Defines the way the process value output reacts to the feedback signal.			
P7.1.7^②	PI dead band			ID 1304
Minimum value:	-99999.99 varies	Maximum value:	99999.99 varies	Default value: 0 varies
Description:	PI dead band around setpoint in process units. This is the band where no actions occur to prevent oscillation or repeated activation/deactivation of controller. The PI output is locked if the feedback stays within the dead band area.			

Table 45. PI Controller (Cont.).

P7.1.8^②	PI dead band delay			ID 1306
Minimum value:	0.00 s	Maximum value:	320.00 s	Default value: 0.00 s
Description:	If the PI process value goes out of the dead band area for the desired time delay, at that point the controller will re-initialize and try to level out again.			
P7.1.9^②	PI ramp time			ID 1311
Minimum value:	0.00 s	Maximum value:	300.00 s	Default value: 0.00 s
Description:	Defines the rising and falling ramp times for changes in the process value.			

① Parameter value can only be changed after the drive has stopped.

② Parameter value will be set to be default when changing macros.

Table 46. Setpoint.

P7.2.1 - Standard.				
P7.2.1.1^②	PI keypad setpoint 1			ID 1307
Minimum value:	PI Process Unit Min	Maximum value:	PI Process Unit Max	Default value: 0.00 varies
Description:	Keypad PI reference value setpoint 1.			
P7.2.1.2^②	PI keypad setpoint 2			ID 1309
Minimum value:	PI Process Unit Min	Maximum value:	PI Process Unit Max	Default value: 0.00 varies
Description:	Keypad PI reference value setpoint 2.			
P7.2.1.3^②	PI wake-up action			ID 2466
Minimum value:	N.A.	Maximum value:	N.A.	Default value: 0
Options:	0 = Wake-up when below wake-up level. 1 = Wake-up when above wake-up-level. 2 = Wake-up when below wake-up level % from PI setpoint. 3 = Wake-up when above wake-up level %from PI setpoint.			
Description:	This parameter defines the wake-up function action.			
P7.2.2 - Setpoint 1.				
P7.2.2.1^①	PI setpoint 1 source			ID 1312
Minimum value:	N.A.	Maximum value:	N.A.	Default value: 1
Options:	0 = Not used; 1 = PI keypad setpoint 1; 2 = PI keypad setpoint 2; 3 = AI; 4 = Drive reference pot; 5 = FB process data input 1; 6 = FB process data input 2; 7 = FB process data input 3; 8 = FB process data input 4; 9 = FB process data input 5; 10 = FB process data input 6; 11 = FB process data input 7; 12 = FB process data input 8; 13 = FB PI setpoint 1; or 14 = FB PI setpoint 2.			
Description:	Defines source of the setpoint value the drive uses. This can either be an internal preset value, keypad setpoint, analog signal, or fieldbus message.			
P7.2.2.2^①	PI setpoint 1 sleep enable			ID 1315
Minimum value:	N.A.	Maximum value:	N.A.	Default value: 0
Options:	0 = Disabled; or 1 = Enabled.			
Description:	This function will disable the output when the frequency drops below the sleep frequency for the sleep delay time. The output re-engages when feedback rises above the wake-up level.			

Table 46. Setpoint (Cont.).

P7.2.2.3^②	PI setpoint 1 sleep delay			ID 1317
Minimum value:	0.00 s	Maximum value:	3,000.00 s	Default value: 0.00 s
Description:	This parameter sets the delay time after the setpoint drops below the sleep level for this amount of time and then the drives output will shut off till the wake up level is met. It is to prevent large fluctuations when going into the sleep function to save motor run time.			
P7.2.2.4^②	PI setpoint 1 wake-up level			ID 1318
Minimum value:	-99999.99 varies	Maximum value:	99999.99 varies	Default value: 0.00 varies
Description:	Defines the level for the PI feedback value to go above top enable the PI output to be re enabled. This value is based of the % of feedback which can be scaled based off the PI unit min./max, values.			
P7.2.2.5^②	PI setpoint 1 boost			ID 1320
Minimum value:	-2.00 varies	Maximum value:	2.00 varies	Default value: 1.00 varies
Description:	The setpoint can be boosted via a multiplier value.			
P7.2.2.6^②	PI setpoint 1 sleep level			ID 2450
Minimum value:	PID1_ProcessUnitMin Hz	Maximum value:	PID1_ProcessUnitMax Hz	Default value: 0.00 Hz
Description:	Defines the level of which the unit value is used to look at to go into the sleep mode. When the unit drops below this level for the sleep delay time, it will put the drive into the sleep mode.			
P7.2.2.7^②	SP1 sleep mode over cycle time			ID 1842
Minimum value:	0.00 varies	Maximum value:	10.00 varies	Default value: 0.00 varies
Description:	Defines the count the drive come in and out of sleep mode. If multiple times done in this time frame, the drive would trip on "pump over cycle" fault. One cycle is defined when the drive transfers from normal mode to sleep mode. 0 value means do not do the sleep over cycle check and clear "pump over cycle" fault.			
P7.2.2.8^②	SP1 sleep mode maximum cycle time			ID 1843
Minimum value:	0.00 s	Maximum value:	3,600.00 s	Default value: 300.00 s
Description:	Defines the maximum time for sleep over cycle checking.			
P7.2.3 - Setpoint 2.				
P7.2.3.1^①	PI setpoint 2 source			ID 1321
Minimum value:	N.A.	Maximum value:	N.A.	Default value: 1
Options:	0 = Not used; 1 = PI keypad setpoint 1; 2 = PI keypad setpoint 2; 3 = AI; 4 = Drive reference pot; 5 = FB process data input 1; 6 = FB process data input 2; 7 = FB process data input 3; 8 = FB process data input 4; 9 = FB process data input 5; 10 = FB process data input 6; 11 = FB process data input 7; 12 = FB process data input 8; 13 = FB PI setpoint 1; or 14 = FB PI setpoint 2.			
Description:	Defines source of the setpoint value the drive uses. This can either be an internal preset value, keypad setpoint, analog signal, or fieldbus message.			
P7.2.3.2^①	PI setpoint 2 sleep enable			ID 1324
Minimum value:	N.A.	Maximum value:	N.A.	Default value: 0
Options:	0 = Disabled; or 1 = Enabled.			
Description:	This function will disable the output when the frequency drops below the sleep frequency for the sleep delay time. The output re-engages when feedback rises above the wake-up level.			

Chapter 6 - Pump control application

Table 46. Setpoint (Cont.).

P7.2.3.3^①	PI setpoint 2 sleep delay			ID 1326
Minimum value:	0.00 s	Maximum value:	3,000.00 s	Default value: 0.00 s
Description:	This parameter sets the delay time after the setpoint drops below the sleep level for this amount of time and then the drives output will shut off till the wake up level is met. It is to prevent large fluctuations when going into the sleep function to save motor run time.			
P7.2.3.4^①	PI setpoint 2 wake-up level			ID 1327
Minimum value:	-99999.99 varies	Maximum value:	99999.99 varies	Default value: 0.00 varies
Description:	Defines the level for the PI feedback value to go above top enable the PI output to be re enabled. This value is based of the % of feedback which can be scaled based off the PI unit min./max, values.			
P7.2.3.5^①	PI setpoint 2 boost			ID 1329
Minimum value:	-2.00 varies	Maximum value:	2.00 varies	Default value: 1.00 varies
Description:	The setpoint can be boosted via a multiplier value.			
P7.2.3.6^①	PI setpoint 2 sleep level			ID 2452
Minimum value:	PID1_ProcessUnitMin Hz	Maximum value:	PID1_ProcessUnitMax Hz	Default value: 0.00 Hz
Description:	Defines the level of which the unit value is used to look at to go into the sleep mode. When the unit drops below this level for the sleep delay time, it will put the drive into the sleep mode.			
P7.2.3.7^①	SP2 sleep mode over cycle time			ID 1844
Minimum value:	0.00 varies	Maximum value:	10.00 varies	Default value: 0.00 varies
Description:	Defines the count the drive come in and out of sleep mode. If multiple times done in this time frame, the drive would trip on "pump over cycle" fault. One cycle is defined when the drive transfers from normal mode to sleep mode. 0 value means do not do the sleep over cycle check and clear "pump over cycle" fault.			
P7.2.3.8^①	SP2 sleep mode maximum cycle time			ID 1845
Minimum value:	0.00 s	Maximum value:	3,600.00 s	Default value: 300.00 s
Description:	Defines the maximum time for sleep over cycle checking.			

^① Parameter value can only be changed after the drive has stopped.

^② Parameter value will be set to be default when changing macros.

Table 47. Feedback .

P7.3.1 - Standard.				
P7.3.1.1^①	PI feedback gain			ID 1331
Minimum value:	-1,000.00%	Maximum value:	1,000.00%	Default value: 100.00%
Description:	Defines gain associated with the feedback signal from the measuring device.			
P7.3.2 - Feedback 1.				
P7.3.2.1^①	PI feedback 1 source			ID 1332
Minimum value:	N.A.	Maximum value:	N.A.	Default value: 2
Options:	0 = Not used; 1 = AI; 2 = Drive reference pot; 3 = FB process data input 1; or 11 = FB PI feedback.			
Description:	Defines where feedback signal is being fed into the drive, via analog or fieldbus data value.			
P7.3.2.2^①	PI feedback 1 minimum			ID 1333
Minimum value:	-200.00 %	Maximum value:	200.00%	Default value: 0.00%
Description:	Minimum unit value for the feedback signal.			

Table 47. Feedback (Cont.).

P7.3.2.3^①	PI feedback 1 maximim			ID 1334
Minimum value:	-200.00 %	Maximum value:	200.00%	Default value: 100.00%
Description:	Maximim unit value for the feedback signal.			

① Parameter value can only be changed after the drive has stopped.
 ② Parameter value will be set to be default when changing macros.

Table 48. Pump parameters.

P9.1 - Derag (*DM1 PRO).				
P9.1.1^②	Derag cycles			ID 2468
Minimum value:	0.00	Maximum value:	10.00	Default value: 3.00
Description:	This parameter defines the number of cycles in the forward/reverse direction for removing any debris in system.			
P9.1.2^②	Derag at Start/Stop			ID 2469
Minimum value:	N.A.	Maximum value:	N.A.	Default value: 0.00
Options:	0 = Off; 1 = Start; 2 = Stop; 3 = Start and stop; 4 = Digital input; or 5 = Current.			
Description:	Defines how the derage function will become activated; start, stop, both, or based off the digital input.			
P9.1.3^②	Deragging run time			ID 2470
Minimum value:	1.00 s	Maximum value:	3,600.00 s	Default value: 0.00 s
Description:	Defines the length of time the drive will run at the derag speed in the forward and reverse direction.			
P9.1.4^②	Derag speed			ID 2471
Minimum value:	MinFreq Hz	Maximum value:	MaxFreq Hz	Default value: 5.00 Hz
Description:	Defines the frequency the drive will run at in the forward/reverse direction when in the derag mode.			
P9.1.5^②	Derag off delay			ID 2472
Minimum value:	1.00 s	Maximum value:	600.00 s	Default value: 10.00 s
Description:	Defines the length of time the drive will run the derag function when enabled at stop.			
P9.1.6^{①②}	Derag current			ID 1879
Minimum value:	A	Maximum value:	A	Default value: 0.00 A

P9.2 - Start/stop timing (*DM1 PRO).

P9.2.1^{①②}	Valve start			ID 1847
Minimum value:	N.A.	Maximum value:	N.A.	Default value: 0
Options:	0 = Normal; 1 = Damper start; 2 = Damper tout; or 3 = Damper delay.			
Description:	This parameter determines the function of damper.			

Table 48. Pump parameters (Cont.).

P9.2.2 ^{①②}	Valve timeout			ID 1848
Minimum value:	1.00 s	Maximum value:	32,500.00 s	Default value: 5.00 s
Description:	The timeout time used for an interlocked time start, after which the start sequence must be restarted if no acknowledgement contact is received.			
P9.2.3 ^{①②}	Valve delay			ID 1849
Minimum value:	1.00 s	Maximum value:	32,500.00 s	Default value: 5.00 s
Description:	The delay time following a delay start, after which the frequency converter will be started.			
P9.2.4 ^{①②}	Back spin delay			ID 2423
Minimum value:	0.00 s	Maximum value:	32,500.00 s	Default value: 0.00 s
Description:	Run delay time parameter sets the time required for the drive to wait before another run command can be received. During this time, the run signal is given. It is ignored until the time has expired upon which it will then start. This is true for keypad, I/O, or Fieldbus Control places.			
P9.2.5 ^{①②}	Minimum run time			ID 1813
Minimum value:	0.00 s	Maximum value:	32,500.00 s	Default value: 0.00 s
Description:	Drive minimum run time.			
P9.2.6 ^②	Minimum frequency ramp time			ID 1850
Minimum value:	0.10 s	Maximum value:	2,000.00 s	Default value: 10.00
Description:	Ramp time for output to minimum frequency.			
P9.3 - Multi-pump multi-drive (*DM1 PRO).				
P9.3.1 ^{①②}	Multi-pump mode			ID 2279
Minimum value:	N.A.	Maximum value:	N.A.	Default value: 0
Options:	0 = Disabled or 1 = Multi-drive network.			
Description:	Determines the number of drives being used in the multi-pump configuration: 0 = Single drive - single drive for main motor, contactors used on other motors; or 1 = Multi-drive - multi-follower sequence with multiple drives.			
P9.3.2 ^{①②}	Number of drives			ID 2449
Minimum value:	1	Maximum value:	5	Default value: 1
Description:	This defines the number of drives active when doing the multi-drive pump and fan scheme. By default, there will be always one drive active at one time. By setting value to above one, it allows for bringing in additional drives to maintain the system.			

Table 34. Pump parameters (Cont.).

P9.3.3 ^{①②}	Drive ID			ID 2278
Minimum value:	0	Maximum value:	5	Default value: 0
Description:	This parameter defines the drive address when using multi-drive pump mode. Based off this ID, the drive enables in the desired sequence and can be monitored at this drive ID value in the monitor screen.			
P9.3.4 ^{①②}	Regulation source			ID 2284
Minimum value:	N.A.	Maximum value:	N.A.	Default value: 0
Options:	0 = Network only or 1 = PI controller.			
Description:	For drives that have been connected with both start/stop signal and PI feedback - can be set up as "Feedback", so they will have ability to be the master.			
P9.3.5 ^②	PI bandwidth			ID 2458
Minimum value:	0.00 varies	Maximum value:	6,000.00 varies	Default value: 10.00 varies
Description:	Percentage based off the setpoint above and below which defines when the auxiliary motor will come online or offline.			

Table 34. Pump parameters (Cont.).

P9.3.6^{①②}	Staging frequency			ID 2315
Minimum value:	MinFreq	Maximum value:	400.00	Default value: 50.00
Description:	Output frequency is above staging frequency and PI error is out of PI bandwidth - motor should add to system.			
P9.3.7^{①②}	De-staging frequency			ID 2316
Minimum value:	0.00	Maximum value:	MaxFreq	Default value: 0.00
Description:	Output frequency is below de-staging frequency and PI error is out of PI bandwidth - motor should remove from system.			
P9.3.8^②	Add/remove delay			ID 344
Minimum value:	0.00 s	Maximum value:	3,600.00 s	Default value: 10.00 s
Description:	With feedback outside the bandwidth, this time must pass before motors/pumps are added or removed from the system.			
P9.3.9^②	Interlock enabled			ID 350
Minimum value:	N.A.	Maximum value:	N.A.	Default value: 0
Options:	0 = Disabled or 1 = Enabled.			
Description:	This parameter enables the drive to look at the digital input interlocks to tell which motor is available for running or if they were brought offline.			
P9.3.10^{①②}	Recovery method			ID 2285
Minimum value:	N.A.	Maximum value:	N.A.	Default value: 0
Options:	0 = Automatic or 1 = Stop.			
Description:	This parameter is for the slave when multi-drive system lost the master. The slave drive can continue run if it set to be "Automatic". However, the slave drive will stop immediately if it is set to be "Stop".			
P9.3.11^②	Add/remove drive selection			ID 2311
Minimum value:	N.A.	Maximum value:	N.A.	Default value: 0
Options:	0 = Drive ID or 1 = Run time.			
Description:	In default, MPFC system will add/remove pump according to their drive ID, from small to large. The order can also depend on each slave drive's running time: add the drive that has shortest running time and remove the drive that has longest running time first.			
P9.3.12^②	Run time enabled			ID 2280
Minimum value:	N.A.	Maximum value:	N.A.	Default value: 0
Options:	0 = Disabled or 1 = Enabled.			
Description:	The run time counter will start counting only if this parameter is enabled.			
P9.3.13^②	Run time limit			ID 2281
Minimum value:	0.00 h	Maximum value:	300,000.00 h	Default value: 0.00 h
Description:	If drive run time is over this limit, its network status will be "Need Alternation". Limit equals 0 means run time counter disabled.			
P9.3.14	Run time reset			ID 2283
Minimum value:	N.A.	Maximum value:	N.A.	Default value: N.A.
Options:	0 = No action or 1 = Reset.			
Description:	One-time parameter, set to be 1 will clear run time counter.			
P9.3.15^②	Master drive mode			ID 2473
Minimum value:	N.A.	Maximum value:	N.A.	Default value: 0
Options:	0 = Follow PI; 1 = Fixed speed; or 2 = Turn off.			
Description:	Defines how the master drive will maintain the frequency control when slaves are brought in; follow PI, fixed speed, or turn off.			

Table 34. Pump parameters (Cont.).

P9.3.16^②	Master fixed speed			ID 2474
Minimum value:	MinFreq Hz	Maximum value:	MaxFreq Hz	Default value: 50.00 Hz
Description:	Defines the fixed speed frequency when the master drive mode is set for fixed speed control when slaves are brought in.			
P9.3.17^②	Master fixed speed delay			ID 2475
Minimum value:	0.00 s	Maximum value:	1,000.00 s	Default value: 5.00 s
Description:	Defines the delay time before the master drive begins running at the fixed speed or turns off if the master mode is set for fixed speed or turn off.			
P9.4 - Pipe fill (Loss of prime) (*DM1 PRO).				
P9.4.1^{①②}	Pipe fill loss response			ID 2410
Minimum value:	N.A.	Maximum value:	N.A.	Default value: 0
Options:	0 = No action; 1 = Warning; 2 = Fault; or 3 = Fault, coast.			
Description:	Defines the response method when a "loss of prime" condition occurs.			
P9.4.2^{①②}	Pipe fill loss detection method			ID 2406
Minimum value:	N.A.	Maximum value:	N.A.	Default value: 0
Options:	0 = Motor current; 1 = Motor power (%); or 2 = Motor torque (%).			
Description:	Defines the value for looking at a loss of prime.			
P9.4.3^②	Pipe fill loss low level			ID 2407
Minimum value:	0.00 varies	Maximum value:	1,000.00 varies	Default value: 0.00 varies
Description:	If the monitor value is less than low level value and the output frequency is more than low frequency, check the pipe fill loss start.			
P9.4.4^{①②}	Pipe fill loss low frequency			ID 2409
Minimum value:	0.00 Hz	Maximum value:	MaxFreq Hz	Default value: 0.00 Hz
Description:	Defines the frequency point at which the drive needs to be above to enable the "loss of prime" feature. When set to 0 Hz, protection is disabled.			
P9.4.5^②	Pipe fill loss high level			ID 1851
Minimum value:	0.00 varies	Maximum value:	1,000.00 varies	Default value: 0.00 varies
Description:	If the monitor value is more than high level (the high level is not 0) and the output frequency is more than high frequency, check pipe fill loss start.			
P9.4.6^{①②}	Pipe fill loss high frequency			ID 1852
Minimum value:	0.00 Hz	Maximum value:	MaxFreq Hz	Default value: 0.00 Hz
Description:	Defines high frequency point at which the drive needs to be above to enabled the "loss of prime" feature. When set to 0 Hz, protection is disabled.			
P9.4.7^②	Pipe fill loss time			ID 2408
Minimum value:	0.00 s	Maximum value:	600.00 s	Default value: 0.00 s
Description:	Defines the delay time before a "loss of prime" condition will occur based of the detection method and prime loss level.			
P9.4.8^②	Pipe fill loss attempts			ID 2411
Minimum value:	0.00	Maximum value:	10.00	Default value: 1.00
Description:	Defines the amount of attempts to auto restart the drive on a "prime loss" condition.			

Table 34. Pump parameters (Cont.).

P9.5 - Prime pump (*DM1 PRO).					
P9.5.1^②	Prime pump enable				ID 2428
Minimum value:	N.A.	Maximum value:	N.A.	Default value:	0
Options:	0 = Disabled; or 1 = Enabled.				
Description:	Prime pump enable.				
P9.5.2^②	Prime pump level				ID 2429
Minimum value:	0.00 varies	Maximum value:	6,000.00 varies	Default value:	0.00 varies
Description:	This defines the level at which the pre-charge function will drop out. If the feedback level raises above this value, pre-charge becomes deactivated. If the level is not reached, it will switch after the delay time.				
P9.5.3^②	Prime pump frequency				ID 2431
Minimum value:	MinFreq Hz	Maximum value:	MaxFreq Hz	Default value:	0.00 Hz
Description:	Frequency at which the pre-charge function will operate when enabled.				
P9.5.4^②	Prime pump delay time				ID 2432
Minimum value:	0.00 min.	Maximum value:	3,600.00 min.	Default value:	0.00 min.
Description:	This is the time that the drive will run the pre-charge function on start up. When set to "0 Hz", this function is not enabled.				
P9.5.5^②	Prime pump loss of prime level				ID 2433
Minimum value:	0.00 varies	Maximum value:	1,000.00 varies	Default value:	0.00 varies
Description:	Selects the limit to indicate a loss of prime in pump. If the measured current drops below the determined value for the value assigned in the prime loss of time setting, the drive will display "pre-charge loss of prime".				
P9.5.6^②	Prime pump level 2				ID 2434
Minimum value:	0.00 varies	Maximum value:	6,000.00 varies	Default value:	0.00 varies
Description:	This defines the level at which the pre-charge function will drop out. If the feedback level raises above this value, pre-charge becomes deactivated. If the level is not reached, it will switch after the delay time.				
P9.5.7^②	Prime pump frequency 2				ID 2436
Minimum value:	MinFreq Hz	Maximum value:	MaxFreq Hz	Default value:	0.00 Hz
Description:	Frequency at which the pre-charge level 2 will operate at when enabled.				
P9.5.8^②	Prime pump delay time 2				ID 2437
Minimum value:	0.00 s	Maximum value:	3,600.00 s	Default value:	0.00 s
Description:	This is the time that the drive will run at the 2nd level pre-charge function level. When set to "0 Hz", this function is not enabled.				
P9.5.9^②	Prime pump loss of prime level 2				ID 2438
Minimum value:	0.00 varies	Maximum value:	1,600.00 varies	Default value:	0.00 varies
Description:	Selects the limit to indicate a loss of prime in pump. If the measured current drops below the determined value for the value assigned in the prime loss of time setting, the drive will display pre-charge loss of prime.				
P9.6 - Broken pipe (*DM1 PRO).					
P9.6.1^{①②}	Broken pipe fault response				ID 1853
Minimum value:	N.A.	Maximum value:	N.A.	Default value:	0
Options:	0 = No action; 1 = Warning; 2 = Fault, coast; or 3 = Fault.				
Description:	Broken pipe fault/warning shall be triggered if the PI feedback is less than broken pipe level and the drive output frequency is more than broke pipe frequency for delay time.				
P9.6.2^②	Broken pipe level				ID 1854
Minimum value:	0.00 varies	Maximum value:	6,000.00 varies	Default value:	15 varies
Description:	Broken pipe level.				

Table 34. Pump parameters (Cont.).

P9.6.3^①	Broken pipe frequency			ID 1856
Minimum value:	1.00 Hz	Maximum value:	MaxFreq Hz	Default value: 25.00 Hz
Description:	Broken pipe frequency.			
P9.6.4^②	Broken pipe delay			ID 1855
Minimum value:	1.00 s	Maximum value:	120.00 s	Default value: 15.00 s
Description:	Broken pipe delay time.			

① Parameter value can only be changed after the drive has stopped.

② Parameter value will be set to be default when changing macros.

Table 49. Serial communication .

P11.1 - Basic settings.				
P11.1.1^①	Serial communication			ID 586
Minimum value:	N.A.	Maximum value:	N.A.	Default value: 0
Options:	0 = Modbus RTU; 1 = BACnet MSTP; or 2 = SWD.			
Description:	This parameter defines the communication protocol for RS-485.			
P11.2 - Modbus RTU.				
P11.2.1^①	Slave address			ID 587
Minimum value:	1.00 varies	Maximum value:	247.00 varies	Default value: 1.00 varies
Description:	This parameter defines the slave address for RS-485 communication.			
P11.2.2^①	Baud rate			ID 584
Minimum value:	N.A.	Maximum value:	N.A.	Default value: 1
Options:	0 = 9,600; 1 = 19,200; 2 = 38,400; 3 = 57,600; or 4 = 115,200			
Description:	This parameter defines communication speed for RS-485 communication.			
P11.2.3^①	Parity type			ID 585
Minimum value:	N.A.	Maximum value:	N.A.	Default value: 2
Options:	0 = None; 1 = Odd; or 2 = Even.			
Description:	This parameter defines parity type for RS-485 communication.			
P11.2.4	Modbus RTU protocol status			ID 588
Minimum value:	N.A.	Maximum value:	N.A.	Default value: N.A.
Options:	0 = Initial; 1 = Stopped; 2 = Operational; or 3 = Faulted.			
Description:	This parameter shows the protocol status for RS-485 communication.			
P11.2.5	Communication timeout modbus RTU			ID 593
Minimum value:	0.00 ms	Maximum value:	60,000.00 ms	Default value: 10,000.00 ms
Description:	Selects the time to wait before a communication fault occurs over modbus RTU if a message is not received.			

Table 49. Serial communication (Cont.).

P11.2.6	Modbus RTU fault response			ID 2516
Minimum value:	N.A.	Maximum value:	N.A.	Default value: 0
Options:	0 = Only in fieldbus control mode. When fieldbus is the control place and fieldbus fault is active, the drive will fault on loss of communications; if not in fieldbus control, place will not fault. 1 = In all control modes. No matter the control place setting, if communication is lost, fieldbus fault response will occur.			
Description:	Defines the fieldbus fault condition for modbus RTU communication.			
P11.3 - BACnet RTU MSTP.				
P11.3.1^①	MSTP baud rate			ID 594
Minimum value:	N.A.	Maximum value:	N.A.	Default value: 2
Options:	0 = 9,600; 1 = 19,200; 2 = 38,400; 3 = 76,800; or 4 = 115,200.			
Description:	This parameter defines the communication speed for RS-485 communication.			
P11.3.2^①	MSTP device address			ID 595
Minimum value:	0	Maximum value:	127	Default value: 1
Description:	Defines the device address of the drive on the BACnet MSTP network.			
P11.3.3^①	MSTP instance number			ID 596
Minimum value:	0	Maximum value:	4,194,302	Default value: 0
Description:	Defines the instance number of the drive on the BACnet MSTP network.			
P11.3.4	MSTP communication timeout			ID 598
Minimum value:	0 ms	Maximum value:	60,000 ms	Default value: 10,000 ms
Description:	Selects the time to wait before a communication fault occurs over BACnet MSTP if a message is not received.			
P11.3.5	MSTP protocol status			ID 599
Minimum value:	N.A.	Maximum value:	N.A.	Default value: N.A.
Options:	0 = Stopped; 1 = Operational; or 2 = Faulted.			
Description:	This parameter shows the protocol status for BACnet MSTP communication.			
P11.3.6	MSTP fault code			ID 600
Minimum value:	N.A.	Maximum value:	N.A.	Default value: N.A.
Options:	0 = None; 1 = Sole master; 2 = Duplicate MAC ID; or 3 = Baud rate fault.			
Description:	This parameter shows the protocol status for BACnet MSTP communication.			
P11.3.7	MSTP fault response			ID 2526
Minimum value:	N.A.	Maximum value:	N.A.	Default value: 0
Options:	0 = Only in fieldbus control mode - when fieldbus is the control place and fieldbus fault is active, the drive will fault on loss of communications. If not in fieldbus control, place will not fault. 1 = In all control modes - no matter the control place setting. If communication is lost, fieldbus fault response will occur.			
Description:	Defines the fieldbus fault condition for BACnet MSTP communication.			
P11.3.8^①	MSTP maximum master			ID 1537
Minimum value:	1	Maximum value:	127	Default value: 127
Description:	Defines the maximum number of masters that can establish connections with the drive.			

Chapter 6 - Pump control application

Table 49. Serial communication (Cont.).

P11.5 - SWD.				
P11.5.1	Parameter access			ID 2630
Minimum value:	N.A.	Maximum value:	N.A.	Default value: 1
Options:	0 = No permission to read/write on acyclic channel. 1 = Acyclic read/write are allowed on Profibus.			
Description:	PNU927 which specifies the operation priority of parameters for acyclic communication.			
P11.5.2^①	Parameter data access			ID 2631
Minimum value:	N.A.	Maximum value:	N.A.	Default value: 4
Options:	0 = Local control; 1 = Fieldbus; 2 = Mixed interface; 4 = NET, local on fault; or 5 = Dual mode.			
Description:	PNU928 which specifies the control priority of the device for cyclic communication.			
P11.5.3	Fault situation counter			ID 2632
Minimum value:	N.A.	Maximum value:	N.A.	Default value: N.A.
Description:	PNU952 which specifies the fault situation counter. Only write of 0 is allowed, then the whole fault buffer (actual fault situation and all other fault situations) and the fault message counter (parameter 944) are erased.			
P11.5.4	Board status			ID 2609
Minimum value:	N.A.	Maximum value:	N.A.	Default value: 0
Description:	Status of the board. B0-DCOM communication fault. B1-Board HW fault B2-IO1 24 volt overload fault. B3-Profibus communication fault. B4-fieldbus fault.			
P11.5.5	Firmware version			ID 2610
Minimum value:	N.A.	Maximum value:	N.A.	Default value: N.A.
Description:	This parameter provides the firmware version of the SWD.			
P11.5.6	Protocol status			ID 2612
Minimum value:	N.A.	Maximum value:	N.A.	Default value: 0
Options:	0 = Not configured; 1 = Operational; or 2 = Diagnostics.			
Description:	This parameter specifies the protocol status for SWD card.			
P11.6 - Bluetooth.				
P11.6.1	Bluetooth enabled			ID 1895
Minimum value:	N.A.	Maximum value:	N.A.	Default value: 0
Options:	0 = Disabled; or 1 = Enabled.			
Description:	Bluetooth enabled.			
P11.6.2^②	Bluetooth broadcast mode			ID 2920
Minimum value:	N.A.	Maximum value:	N.A.	Default value: 0
Options:	0 = Off; or 1 = On.			
Description:	Bluetooth broadcast mode.			

Table 49. Serial communication (Cont.).

P11.6.3	Bluetooth pairing reset			ID 2935
Minimum value:	N.A.	Maximum value:	N.A.	Default value: N.A.
Options:	0 = Not reset; or 1 = Reset.			
Description:	Bluetooth pairing reset.			

① Parameter value can only be changed after the drive has stopped.

② Parameter value will be set to be default when changing macros.

Table 50. Ethernet communication.

P12.1 - Basic settings.				
P12.1.1 ^①	IP address mode			ID 1500
Minimum value:	N.A.	Maximum value:	N.A.	Default value: 0
Options:	0 = Static IP; or 1 = DHCP with AutoIP.			
Description:	This parameter defined the IP address configuration mode for EIP/modbus TCP.			
P12.1.2	Active IP address			ID 1507
Minimum value:	N.A.	Maximum value:	N.A.	Default value: N.A.
Description:	Reads the current active IP address.			
P12.1.3	Active subnet mask			ID 1509
Minimum value:	N.A.	Maximum value:	N.A.	Default value: N.A.
Description:	Reads the current active subnet mask.			
P12.1.4	Active default gateway			ID 1511
Minimum value:	N.A.	Maximum value:	N.A.	Default value: N.A.
Description:	Reads the current active default gateway.			
P12.1.5	MAC address			ID 1513
Minimum value:	N.A.	Maximum value:	N.A.	Default value: N.A.
Description:	Reads the current MAC address.			
P12.1.6 ^①	Static IP address			ID 1501
Minimum value:	N.A.	Maximum value:	N.A.	Default value: 192.168.1.254
Description:	Defines the static IP address.			
P12.1.7 ^①	Static subnet mask			ID 1503
Minimum value:	N.A.	Maximum value:	N.A.	Default value: 255.255.255.0
Description:	Defines the static subnet mask.			
P12.1.8 ^①	Static default gateway			ID 1505
Minimum value:	N.A.	Maximum value:	N.A.	Default value: 192.168.1.1
Description:	Defines the static default gateway.			
P12.1.9	Ethernet communication timeout			ID 611
Minimum value:	0 ms	Maximum value:	60,000 ms	Default value: 10,000 ms
Description:	Selects the time it waits before a communication fault occurs over ethernet.			

Chapter 6 - Pump control application

Table 50. Ethernet communication (Cont.).

P12.2 - Trusted IP filter (DM1 PRO only).					
P12.2.1	Trusted IP white list				ID 68
Minimum value:	N.A.	Maximum value:	N.A.	Default value:	192.168.1.255 0.0.0. 0 0.0.0.0
Description:	Defines the IP addresses in the white list. A setting of 192.168.1.255 enables all connections on the local subnet.				
P12.2.2	Trusted IP filter enable				ID 76
Minimum value:	N.A.	Maximum value:	N.A.	Default value:	1
Options:	0 = Disabled; or 1 = Enabled.				
Description:	Enables IP white listing. Devices not in the white list will not be able to establish communications with the drive.				
P12.3 - Modbus TCP (DM1 PRO only).					
P12.3.1^①	Modbus TCP enable				ID 1942
Minimum value:	N.A.	Maximum value:	N.A.	Default value:	0
Options:	0 = Disable; or 1 = Enable.				
Description:	Enables modbus TCP communications, must be enabled to connect to Power Xpert inControl.				
P12.3.2	Modbus TCP connection limit				ID 609
Minimum value:	N.A.	Maximum value:	N.A.	Default value:	5
Description:	Maximum number of connections allowed to the drive.				
P12.3.3	Modbus TCP unit identifier number				ID 610
Minimum value:	N.A.	Maximum value:	N.A.	Default value:	1
Description:	Unit identifier unit value for modbus TCP.				
P12.3.4	Modbus TCP protocol status				ID 612
Minimum value:	N.A.	Maximum value:	N.A.	Default value:	N.A.
Options:	0 = Stopped; 1 = Operational; or 2 = Faulted.				
Description:	This parameter shows the protocol status for modbus TCP communication.				
P12.3.5	Modbus TCP fault response				ID 2517
Minimum value:	N.A.	Maximum value:	N.A.	Default value:	0
Options:	0 = Only in fieldbus control mode - when fieldbus is the control place and fieldbus fault is active, the drive will fault on loss of communications. If not in fieldbus control, place will not fault. 1 = In all control modes - no matter the control place setting, if communication is lost, fieldbus fault response will occur.				
Description:	Defines the fieldbus fault condition for modbus TCP communication.				
P12.4 - Ethernet IP (DM1 PRO only).					
P12.4.1^①	Ethernet based protocol select				ID 1997
Minimum value:	N.A.	Maximum value:	N.A.	Default value:	0
Options:	0 = Disabled; or 2 = BACnet IP.				
Description:	Selects the active communication protocol on the ethernet I/P port.				
P12.4.2	Ethernet IP protocol status				ID 608
Minimum value:	N.A.	Maximum value:	N.A.	Default value:	N.A.
Options:	0 = Off; 1 = Operational; or 2 = Faulted.				
Description:	Indicates if ethernet protocol is active or not.				

Table 50. Ethernet communication (Cont.).

P12.4.3	Ethernet IP fault response			ID 2518
Minimum value:	N.A.	Maximum value:	N.A.	Default value: 0
Options:	0 = Only in fieldbus control mode - when fieldbus is the control place and Fieldbus fault is active, the drive will fault on loss of communications. If not in fieldbus control, place will not fault. 1 = In all control modes - no matter the control place setting. If communication is lost, fieldbus fault response will occur.			
Description:	Defines the fieldbus fault condition for ethernet IP communication.			
P12.5 - BACnet IP (DM1 PRO only).				
P12.5.1^①	BACnet IP UDP port number			ID 1733
Minimum value:	N.A.	Maximum value:	N.A.	Default value: 47,808
Options:	47808 = BAC0; 47809 = BAC1; 47810 = BAC2; 47811 = BAC3; 47812 = BAC4; 47813 = BAC5; 47814 = BAC6; 47815 = BAC7; 47816 = BAC8; 47817 = BAC9; 47818 = BACA; 47819 = BACB; 47820 = BACC; 47821 = BACD; 47822 = BACE; or 47823 = BACF.			
Description:	Defines the BACnet UDP port number.			
P12.5.2^①	BACnet IP foreign device			ID 1734
Minimum value:	N.A.	Maximum value:	N.A.	Default value: 0
Options:	0 = Disabled; or 1 = Enabled.			
Description:	Enables BACNET IP foreign device configuration.			
P12.5.3^①	BACnet IP BBMD IP			ID 1735
Minimum value:	N.A.	Maximum value:	N.A.	Default value: 0.0.0.0
Description:	Displays the BACnet BBMD IP address.			
P12.5.4^①	BACnet IP UDP port			ID 1737
Minimum value:	N.A.	Maximum value:	N.A.	Default value: 47,808
Options:	47808 = BAC0; 47809 = BAC1; 47810 = BAC2; 47811 = BAC3; 47812 = BAC4; 47813 = BAC5; 47814 = BAC6; 47815 = BAC7; 47816 = BAC8; 47817 = BAC9; 47818 = BACA; 47819 = BACB; 47820 = BACC; 47821 = BACD; 47822 = BACE; or 47823 = BACF.			
Description:	Displays the BACnet BBMD UDP port number.			
P12.5.5^①	BACnet IP registration interval			ID 1738
Minimum value:	0.00	Maximum value:	65,535	Default value: 10
Description:	Defines the registration interval.			

Chapter 6 - Pump control application

Table 50. Ethernet communication (Cont.).

P12.5.6	BACnet IP communication timeout			ID 1739
Minimum value:	0.00	Maximum value:	60,000	Default value: 0
Description:	Selects the time it waits before a communication fault occurs over BACnet IP.			
P12.5.7	BACnet IP protocol status			ID 1740
Minimum value:	N.A.	Maximum value:	N.A.	Default value: 0
Options:	0 = Stopped; 1 = Operational; or 2 = Faulted.			
Description:	This parameter shows the protocol status for BACnet IP communication.			
P12.5.8	BACnet IP fault behavior			ID 1741
Minimum value:	N.A.	Maximum value:	N.A.	Default value: 0
Options:	0 = Only in fieldbus control mode - when fieldbus is the control place and Fieldbus fault is active, the drive will fault on loss of communications. If not in fieldbus control, place will not fault. 1 = In all control modes - no matter the control place setting. If communication is lost, fieldbus fault response will occur.			
Description:	Defines the fieldbus fault condition for BACnet IP communication.			
P12.5.9^①	BACnet IP instance number			ID 1742
Minimum value:	0	Maximum value:	4,194,302	Default value: 0
Description:	Displays the BACnet instance number.			
P12.6 - Web UI (*DM1 PRO only).				
P12.6.1	Web UI protocol status			ID 2915
Minimum value:	N.A.	Maximum value:	N.A.	Default value: N.A.
Options:	0 = Off; 1 = Operational; or 2 = Faulted.			
Description:	This parameter shows the protocol status for web server communication.			
P12.6.2	Web UI fault response			ID 2916
Minimum value:	N.A.	Maximum value:	N.A.	Default value: 0
Options:	0 = Only in fieldbus control mode - when fieldbus is the control place and fieldbus fault is active, the drive will fault on loss of communications. If not in fieldbus control, place will not fault. 1 = In all control modes - no matter the control place setting. If communication is lost, fieldbus fault response will occur.			
Description:	Defines the fieldbus fault condition for web server communication.			
P12.6.3	Web UI communication timeout			ID 2919
Minimum value:	30,000 ms	Maximum value:	60,000 ms	Default value: 60,000 ms
Description:	Selects the time it waits before a communication fault occurs over the web server.			
P12.6.4^①	Web UI enable			ID 2921
Minimum value:	N.A.	Maximum value:	N.A.	Default value: 0
Options:	0 = Disabled; or 1 = Enabled.			
Description:	Enables web server configuration and monitoring page.			

^① Parameter value can only be changed after the drive has stopped.

Table 51. System.

P13.1.1	Language				ID 340
Minimum value:	N.A.	Maximum value:	N.A.	Default value:	0
Options:	0 = English; 1 = English; or 2 = English.				
Description:	This parameter offers the ability to control the frequency converter through the keypad in the language of your choice. Currently available language is English only.				
P13.1.2^①	Application				ID 142
Minimum value:	N.A.	Maximum value:	N.A.	Default value:	N.A.
Options:	0 = Standard;; 1 = Pump; or 2 = Fan 3 = Multi-purpose.				
Description:	This parameter sets the active application if multiple applications have been loaded.				
P13.1.3^①	Parameter sets				ID 619
Minimum value:	N.A.	Maximum value:	N.A.	Default value:	N.A.
Options:	0 = No; 1 = Reload defaults; 2 = Reload set 1; 3 = Reload set 2; 4 = Store set 1; 5 = Store set 2; 6 = Reset; or 7 = Reload defaults VM.				
Description:	This parameter allows you to reload the factory default parameter values, and to store and load two customized parameter sets.				
P13.1.4	Up to keypad				ID 620
Minimum value:	N.A.	Maximum value:	N.A.	Default value:	N.A.
Options:	0 = No; or 1 = Yes (all parameters).				
Description:	This function uploads all existing parameter groups to the keypad.				
P13.1.5^①	Down from keypad				ID 621
Minimum value:	N.A.	Maximum value:	N.A.	Default value:	N.A.
Options:	0 = No; 1 = All parameters; 2 = All, no motor; or 3 = Application parameters.				
Description:	This function downloads one or all parameter groups from the keypad to the drive.				
P13.1.7	Parameter lock PIN				ID 624
Minimum value:	0	Maximum value:	9,999	Default value:	0
Description:	The application selection can be protected against unauthorized changes with the password function. When the password function is enabled, the user will be prompted to enter a password before application changes, parameter value changes, or password changes. By default, the password function is not in use. If you want to activate the password, change the value of this parameter to any number between 1 and 9,999. To deactivate the password, reset the parameter value to 0.				

Chapter 6 - Pump control application

Table 51. System (Cont.).

P13.1.8	Keypad parameter lock			ID 625
Minimum value:	N.A.	Maximum value:	N.A.	Default value: 0
Options:	0 = Change enable; or 1 = Change disable.			
Description:	This function allows the user to prohibit changes to the parameters. If the parameter lock is activated, the text "locked" will appear on the display if you try to edit a parameter value.			
	Note: This function does not prevent unauthorized editing of parameter values.			
P13.1.9	Start-up Wizard			ID 626
Minimum value:	N.A.	Maximum value:	N.A.	Default value: 0
Options:	0 = Enabled. 1 = Disabled.			
Description:	The Start-up Wizard facilitates commissioning the DM1 PRO. If selected "Enable", the Start-up Wizard prompts the operator for the application desired and then advances parameters through the start-up parameter list/Application Mini wizard in keypad. After completion, it allows the user to go to the main menu or default page and this parameter is set to "Disabled". The Start-up Wizard is always enabled for the initial power up of the DM1 PRO. By setting this parameter to "Disable" without going through the Start-up Wizard, it will not cause it to be active on start-up. If user goes into Start-up Wizard after completion, or defaults drive, the Start-up Wizard will be "Enabled".			
P13.2 - Keypad.				
P13.2.4	Timeout time			ID 629
Minimum value:	1 s	Maximum value:	65.535 s.	Default value: 30 s
Description:	The timeout time setting defines the time after which the keypad display returns to the Default Page.			
	Note: If the default page value is 0, the timeout time setting has no effect.			
P13.2.5	Contrast adjust			ID 630
Minimum value:	5	Maximum value:	18	Default value: 12
Description:	If the remote keypad display is not clear, you can adjust the keypad contrast with this parameter.			
P13.2.6	Backlight time			ID 631
Minimum value:	1 min.	Maximum value:	65.535 min.	Default value: 10 min.
Description:	This parameter determines how long the backlight stays on before going out.			
P13.2.7	Fan control			ID 632
Minimum value:	N.A.	Maximum value:	N.A.	Default value: 2
Options:	0 = Continuous - fan runs continuously. 1 = Temperature - based on the temperature of the unit. The fan is switched on automatically when the heat sink temperature reaches 60°C (140°F). The fan receives a stop command when the heat sink temperature falls to 55°C (131°F). The fan runs for about a minute after receiving the stop command or switching on the power, as well as after changing the value from "Continuous" to "Temperature". 2 = Run follow - after power up, the fan is stopped until the run command is given and then fan runs continuously. This is mainly made for common DC-bus systems to prevent cooling fans to load charging resistors on power up moment.			
Description:	This function allows you to control the DM1 PRO's cooling fan.			
P13.4 - Version information.				
P13.4.1	Keypad software version			ID 640
Minimum value:	N.A.	Maximum value:	N.A.	Default value: N.A.
Description:	Keypad firmware version.			

Table 51. System (Cont.).

P13.4.2	Motor control software version			ID 642
Minimum value:	N.A.	Maximum value:	N.A.	Default value: N.A.
Description:	DSP/motor control software version.			
P13.4.3	Application software version			ID 644
Minimum value:	N.A.	Maximum value:	N.A.	Default value: N.A.
Description:	MCU/application software version.			
P13.4.4	Software bundle version			ID 1714
Minimum value:	N.A.	Maximum value:	N.A.	Default value: N.A.
Description:	Software bundle version.			
P13.5 - Application information.				
P13.5.1	Serial number			ID 648
Minimum value:	N.A.	Maximum value:	N.A.	Default value: N.A.
Description:	Product serial number.			
P13.5.2	Multi-monitor set			ID 627
Minimum value:	N.A.	Maximum value:	N.A.	Default value: 0
Options:	0 = Change enable; or 1 = Change disable.			
Description:	The keypad display can display three actual monitored values at the same time. This parameter determines if the operator is allowed to replace the values monitored with other values.			
P13.5.3	Keypad lock PIN			ID 75
Minimum value:	0	Maximum value:	9,999	Default value: 0
Description:	The keypad can be protected against unauthorized changes with the keypad lock function after keys are not pressed five minutes. When the password function is enabled, the user will be prompted to enter a password before the keypad display parameter or response to key press except up/down/left/right. By default, the password function is not in use. If you want to activate the password, change the value of this parameter to any number between 1 and 9,999. To deactivate the password, reset the parameter value to 0.			
P13.5.4	Drive application name			ID 2922
Minimum value:	N.A.	Maximum value:	N.A.	Default value: N.A.
Description:	Drive application name.			

① Parameter value can only be changed after the drive has stopped.

Chapter 7- Multi-purpose application

Introduction

The multi-purpose application is designed for a large set of applications with the ability to have advanced motor control systems. It takes the same functions provided in the standard, fan, and multi-pump applications and adds in some additional control techniques. The application is designed with two control places that use eight digital inputs, two analog inputs, three relay outputs, one digital output, and two analog outputs that are programmable. Motor control-wise, it provides the ability to do frequency and speed control and adds open loop speed control as well as torque control. For tuning the V/Hz curve, it has the ability to go out and ID the motor characteristic and enters those specific measurements into its parameters for better control. Drive/motor protections are programmable for desired actions depending on the application. Below is a list of additional features available in addition to the standard, fan, and multi-pump application features that are available in the multi-purpose application.

- Motor potentiometer reference control;
- External brake control;
- Droop function with multiple loads;
- Motor identification;
- Motor control modes; and
- I/O controls:
 - “Terminal to function” (TTF) programming

The design behind the programming of the digital inputs in the DM1 drive is to use “terminal to function” programming. It is composed of multiple functions that get assigned a digital input to that function.

The parameters in the drive are set up with specific functions and by defining the digital input and slot in some cases depending on the what options are available. For use of the drives control board inputs, they will be referred to as DigIN:1 through DigIN:8. When additional option cards are used, they will be defined as DigIN:X:IOY:Z. The X indicates the slot that the card is being installed in which will be either A or B, then the IOY determines the type of card it is, which would be IO1 or IO5, and the Z would indicate which input is being used on that available option card.

- “Function to terminal” (FTT) programming

The design behind the programming of the relay outputs and digital output in the DM1 drive is to use “function to terminal” programming. It is composed of a terminal be it a relay output or a digital output that is assigned a parameter. Within that parameter, it has different functions that can be set.

For the DI function, we use terminal programming method to function (TTF), where there is a fixed input that gets programmed to a list of functions. This allows for multiple inputs to be used for different functions. Connecting a certain input with a certain parameter function is done by giving a parameter an appropriate value. The value is formed by the location of the input, either being on the standard control board or an external option board and the slot in which it is located.

Control I/O configuration

- Run 240 Vac and 24 Vdc control wiring in separate conduit.
- Communication wire to be shielded.

Table 52. Multi-purpose application default I/O connection.

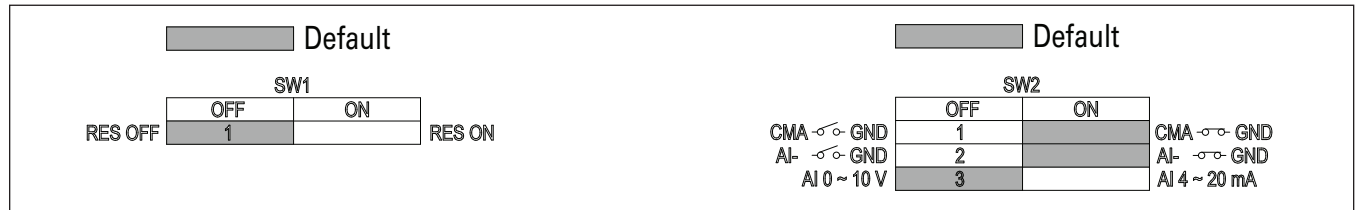

External wiring	Terminal	Short name	Name	Default setting	Description
	1	DI1	Digital input 1	Run forward	Starts the motor in the forward direction.
	2	DI2	Digital input 2	Run reverse	Start the motor in the reverse direction.
	3	DI3	Digital input 3	External fault	Triggers a fault in the drive.
	4	DI4	Digital input 4	Fault reset	Resets active faults in the drive.
	5	CMA	DI1 to DI4 common	Grounded	Allows for sourced input.
	6	A	RS-485 signal A	—	Fieldbus communication (Modbus RTU, BACNet).
	7	B	RS-485 signal B	—	Fieldbus communication (Modbus RTU, BACNet).
	8	AI1+ ①	Analog input 1	0 - 10 V	Voltage speed reference (programmable to 4 mA to 20 mA).
	9	AI1-	Analog input 1 ground	—	Analog input 1 common (ground).
	10	GND	I/O signal ground	—	I/O ground for reference and control.
	11	AO1+	Analog output 1	Output frequency	Shows output frequency to motor 0 - 60 Hz (4 mA to 20 mA).
	12	GND	I/O signal ground	—	I/O ground for reference and control.
	13	10 V	10 Vdc reference output	10.3 Vdc +/- 3%	10 Vdc reference voltage.
	14	24 V	24 Vdc control output	24 Vdc In/Out	Control voltage input/output (100 mA max.).
	15	STO1	Safe torque Off 1	—	Safe torque Off 1 input.
	16	STO2	Safe torque Off 2	—	Safe torque Off 2 input.
	17	STO_COM	Safe torque common	—	Safe torque Off common.
	18	R1NO	Relay 1 normally open	Run	Changes state when the drive is in the run state.
	19	R1CM	Relay 1 common		
	20	R1NC	Relay 1 normally closed		
	21	R2NO	Relay 2 normally open	Fault	Changes state when the drive is in the fault state.
	22	R2CM	Relay 2 common		

Notes:

The above wiring demonstrates a SINK configuration. It is important that CMA is wired to ground (as shown by dashed line). If a SOURCE configuration is desired, wire 24 V to CMA and close the inputs to ground. When using the +10 V for AI1, it is important to wire AI1- to ground (as shown by dashed line). If using +10 V for AI1, terminals 9 and 10 need to be jumpered together.

① AI1+ support 10 K potentiometer.

Figure 9. Example application with three auxiliary drives.

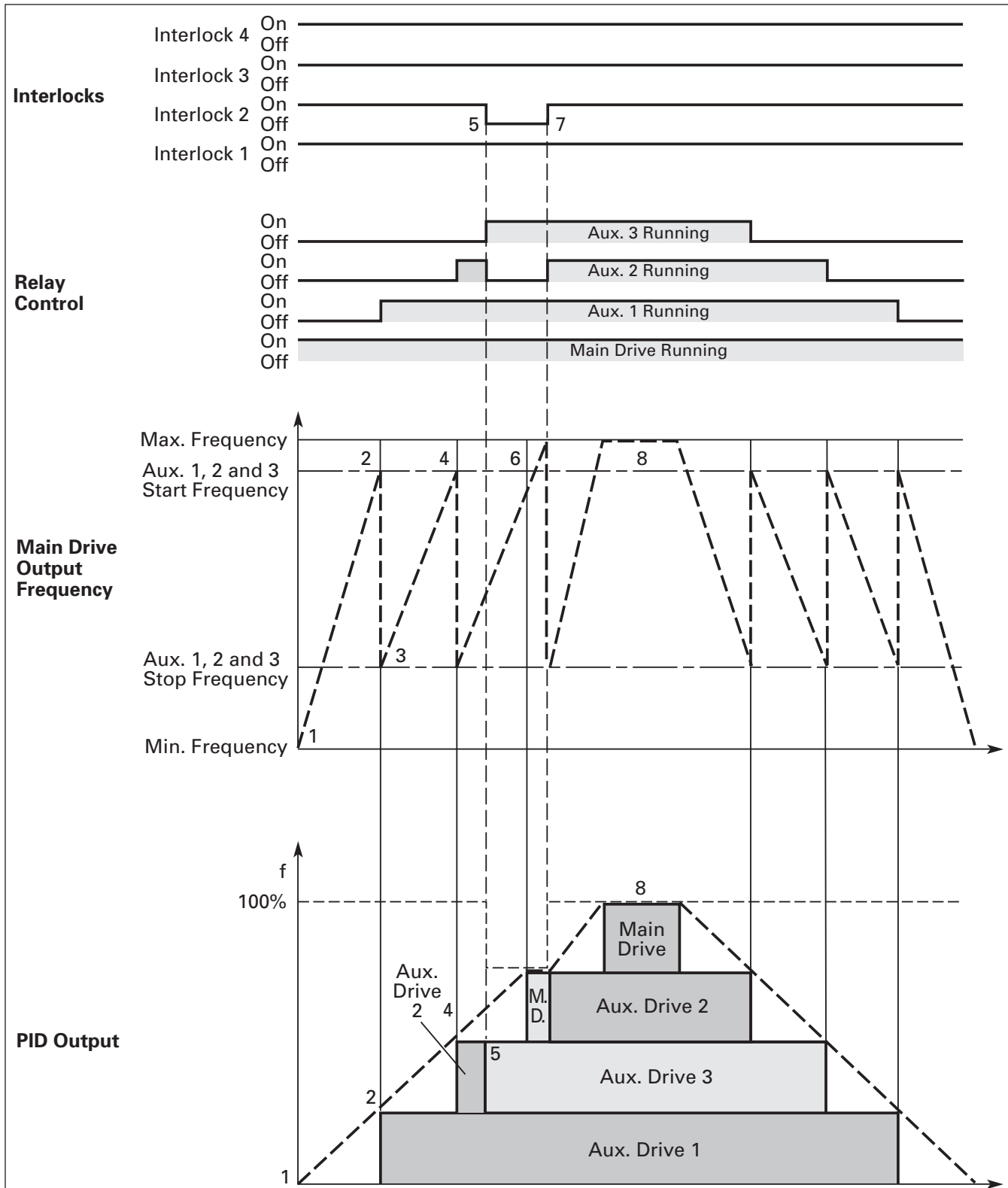

Figure 10. Multi-pump control curve.

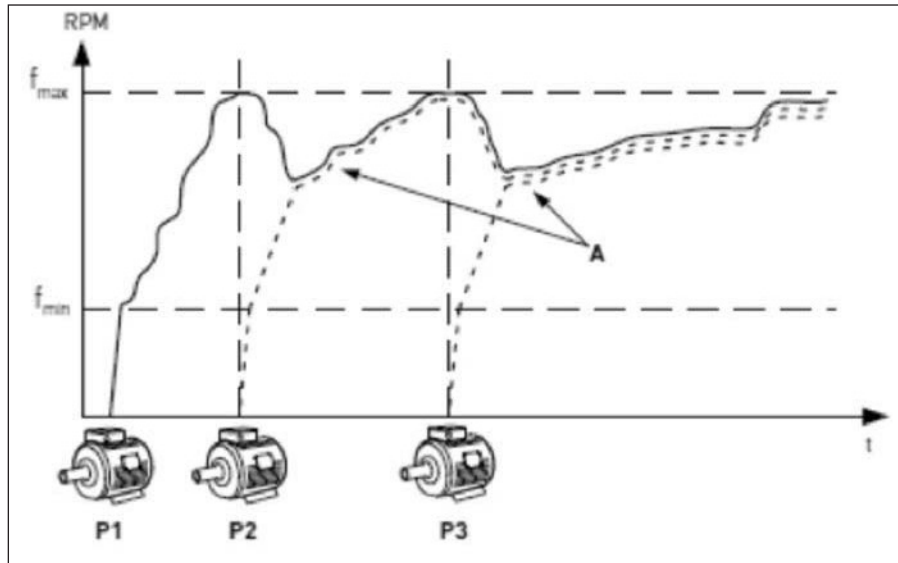

Figure 11. Multi-drive/multi-pump layout.

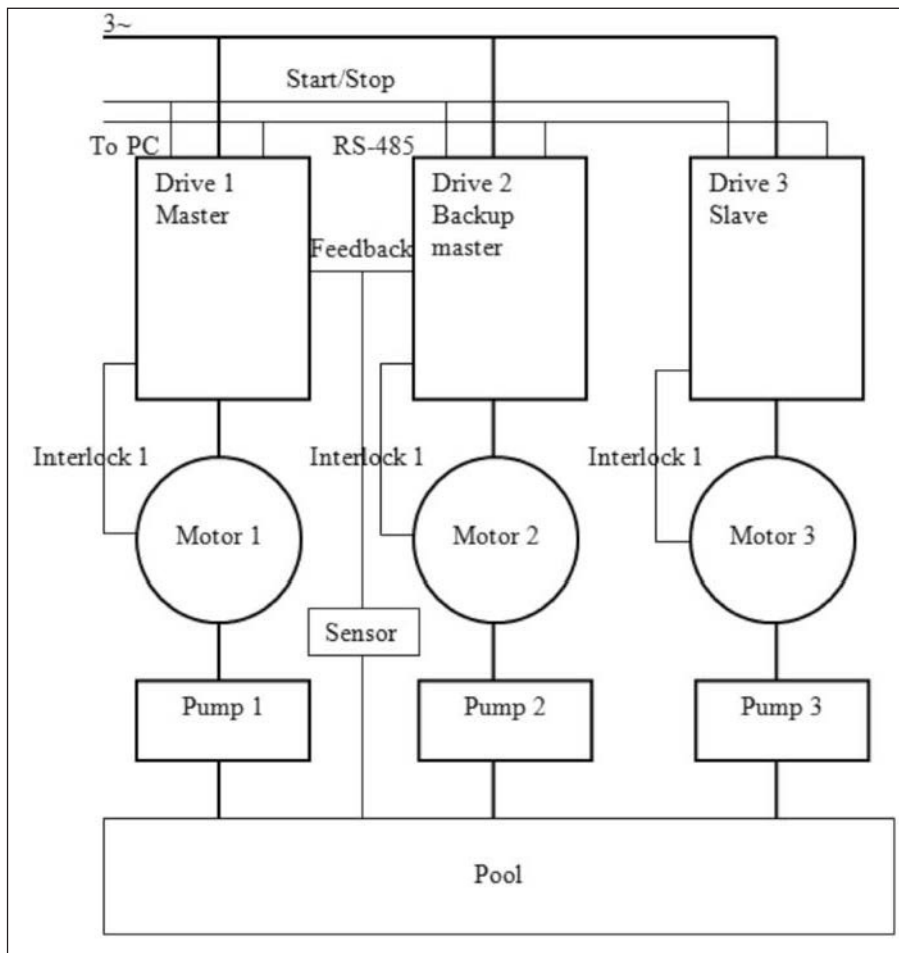
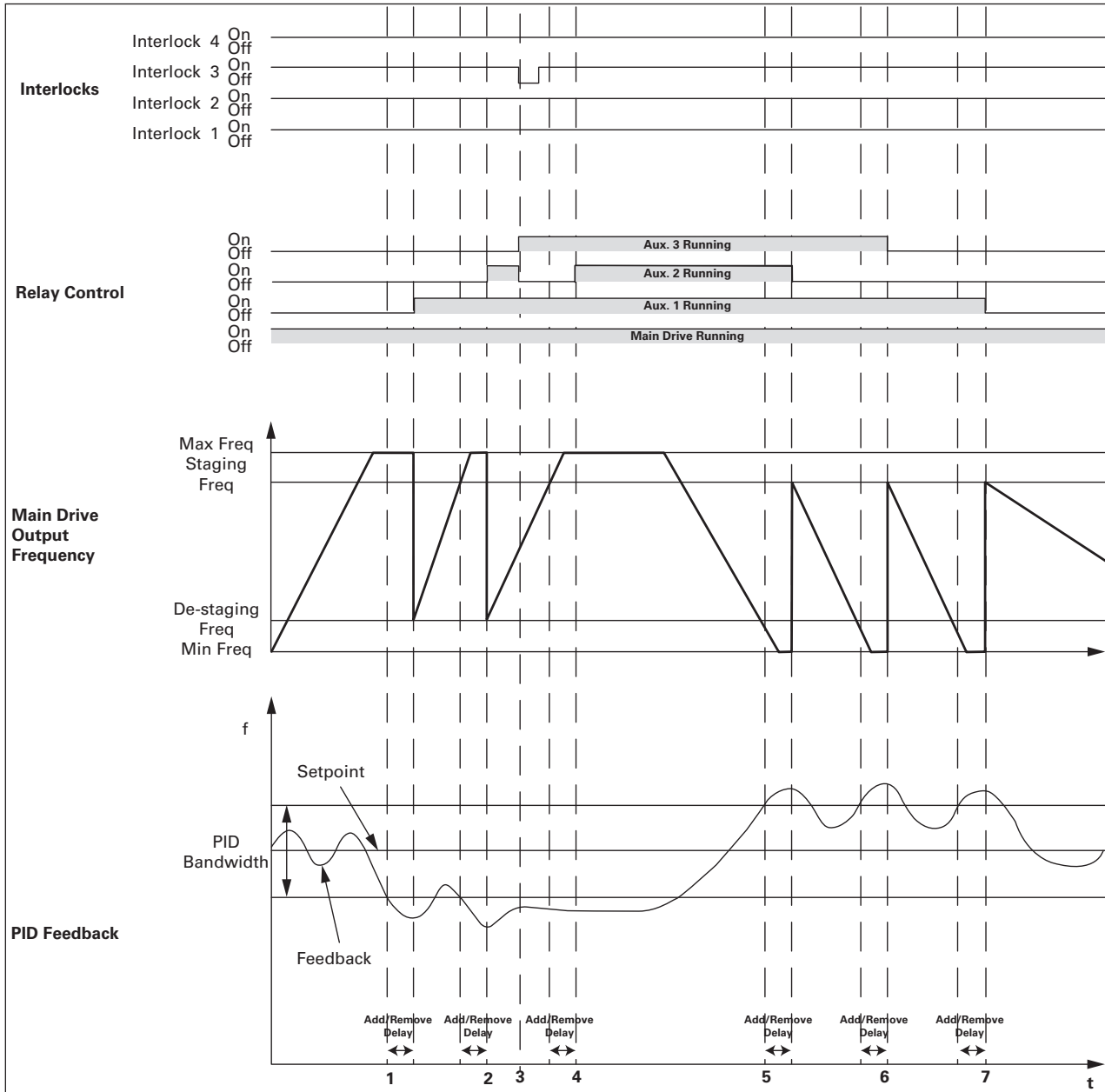

Figure 12. Bandwidth feedback.



1. Feedback out of bandwidth, output frequency over staging frequency, start delay counter; delay times out, and interlock 2 is OK, add aux. 1 motor by closing its corresponding relay.
2. As above, add aux. 2 motor.
3. Aux. 2's interlock lost, add aux. 3 as backup immediately.
4. Add aux. 2 motor again since its interlock resumed.
5. Feedback out of bandwidth, output frequency below de-staging frequency, start delay counter; delay times out, remove aux. 2 motor first because it's the last one which been added.
6. As above, remove aux. 3 motor.
7. As above, remove aux. 1 motor.

Multi-purpose application - parameters list

On the next pages you will find the lists of parameters within the respective parameter groups. Each parameter section within the table lists:

- Parameter code (location indication on the keypad; shows the operator the present parameter number);
- Parameter name;
- ID (number of the parameter);

and where applicable:

- Minimum value and units;
- Maximum value and units;
- Default value and units;
- Options (when available); and
- Description of the parameter.

Table 53. Monitor.

M1 - standard.				
M1.1	Output frequency			ID 1
Minimum value:	Hz	Maximum value:	Hz	Default value: Hz
Description:	Output frequency (Hz).			
M1.2	Frequency reference			ID 24
Minimum value:	Hz	Maximum value:	Hz	Default value: Hz
Description:	Reference frequency (Hz).			
M1.3	Motor speed			ID 2
Minimum value:	rpm	Maximum value:	rpm	Default value: rpm
Description:	Motor output speed (rpm).			
M1.4	Motor current			ID 3
Minimum value:	A	Maximum value:	A	Default value: A
Description:	Motor output current RMS (Amps).			
M1.5	Motor torque			ID 4
Minimum value:	%	Maximum value:	%	Default value: %
Description:	Percent motor torque calculated from nameplate values and measured motor current (%).			
M1.6	Motor power			ID 5
Minimum value:	%	Maximum value:	%	Default value: %
Description:	Percent motor power calculated from nameplate values and measured motor current (%).			
M1.7	Motor voltage			ID 6
Minimum value:	V	Maximum value:	V	Default value: V
Description:	Output ac motor voltage (Vac).			
M1.8	DC-link voltage			ID 7
Minimum value:	V	Maximum value:	V	Default value: V
Description:	DC bus voltage (Vdc).			
M1.9	Unit temperature			ID 8
Minimum value:	°C	Maximum value:	°C	Default value: °C
Description:	Heat sink temperature (deg C).			

Chapter 7- Multi-purpose application

Table 53. Monitor (Cont.).

M1 - standard (Cont.).					
M1.10	Motor temperature				ID 9
Minimum value:	%	Maximum value:	%	Default value:	%
Description:	Motor temperature value calculated from nameplate values and measured motor current (%).				
M1.11	Latest fault code				ID 28
Minimum value:	N.A.	Maximum value:	N.A.	Default value:	N.A.
Description:	Last active fault code value. See fault codes for the value shown here.				
M1.12	Instant motor power				ID 1686
Minimum value:	kW	Maximum value:	kW	Default value:	kW
Description:	Instantaneous motor power (kW).				
M2 - I/O status.					
M2.1	Analog input 1				ID 10
Minimum value:	Varies	Maximum value:	Varies	Default value:	Varies
Description:	Analog input 1 measured value (Vdc or Amps) selectable with dipswitch.				
M2.2	Keypad pot voltage				ID 1858
Minimum value:	V	Maximum value:	V	Default value:	V
Description:	Keypad potentiometer measured value (Vdc). DM1 PRO only.				
M2.3	Analog output				ID 25
Minimum value:	Varies	Maximum value:	Varies	Default value:	Varies
Description:	Analog output 1 measured value (Vdc or Amps) selectable with parameter.				
M2.4	DI1, DI2, DI3				ID 12
Minimum value:	N.A.	Maximum value:	N.A.	Default value:	N.A.
Description:	Digital input 1/2/3 status.				
M2.5	DI4				ID 13
Minimum value:	N.A.	Maximum value:	N.A.	Default value:	N.A.
Description:	Digital input 4 status.				
M2.6	Virtual DI1, Virtual DI2				ID 1998
Minimum value:	N.A.	Maximum value:	N.A.	Default value:	N.A.
Description:	Virtual digital output status. Internal use, not external output. The virtual RO1 as virtual DI1 input. The virtual RO2 as virtual DI2 input.				
M2.7	Virtual RO1, Virtual RO2				ID 1817
Minimum value:	N.A.	Maximum value:	N.A.	Default value:	N.A.
Description:	Virtual relay output 1 and 2 status.				
M2.8	RO1, RO2				ID 557
Minimum value:	N.A.	Maximum value:	N.A.	Default value:	N.A.
Description:	Relay output 1 and 2 status.				
M3 - Energy savings					
M3.1[®]	Energy savings				ID 2120
Minimum value:	Varies	Maximum value:	Varies	Default value:	0.000 varies
Description:	Displays the energy savings of the drive compared to linear V/f curve.				

Table 53. Monitor (Cont.).

M3.2[®]	CO2 savings			ID 1818
Minimum value:	mt/y	Maximum value:	mt/y	Default value: 0.000 mt/y
Description:	Displays the CO2 savings of the drive compared to linear V/f curve.			
M4 - FB monitor menu.				
M4.1	Control board DIDO status			ID 2209
Minimum value:	N.A.	Maximum value:	N.A.	Default value: N.A.
Options:	Bit 0 = DI1_Status; Bit 1 = DI2_Status; Bit 2 = DI3_Status; Bit 3 = DI4_Status; Bit 4 = RO1_Status; Bit 5 = RO2_Status; Bit 6 = SlotA with board; Bit 7 = Virtual_RO1_Status; or Bit 8 = Virtual_RO2_Status.			
Description:	Control board digital input and relay output status provides the status of inputs and outputs on the control board.			
M4.2	Application status word			ID 29
Minimum value:	N.A.	Maximum value:	N.A.	Default value: N.A.
Options:	Bit 0 = MC_Ready; Bit 1 = MC_Run; Bit 2 = MC_Fault or Fault Trip; Bit 3 = FB_Ref_Active; Bit 4 = MC_Stopping; Bit 5 = MC_Reverse; Bit 6 = MC_Warning or AR-Fault; Bit 7 = MC_ZeroSpeed; Bit 8 = IO control indicator; Bit 9 = Panel control indicator; Bit 10 = Panel fieldbus control indicator; Bit 11 = MC_DC_Brake; Bit 12 = Run enable; Bit 13 = Run bypass; Bit 14 = External brake control; or Bit 15 = In bypass mode.			
Description:	Application status word will provide additional status indication of the health of the drive.			
M4.3	Standard status word			ID 2414
Minimum value:	N.A.	Maximum value:	N.A.	Default value: N.A.
Options:	Bit 0 = See STD status word B0 Sel (default = ready); Bit 1 = See STD status word B1 Sel (default = run); Bit 2 = See STD status word B2 Sel (default = fault); Bit 3 = See STD status word B3 Sel (default = fault Invert); Bit 4 = See STD status word B4 Sel (default = warning); Bit 5 = See STD status word B5 Sel (default = reversed); Bit 6 = See STD status word B6 Sel (default = at speed); Bit 7 = See STD status word B7 Sel (default = zero frequency); or Bit 8 - 15 = Not used.			
Description:	Standard status word is defined based of the parameter setting in the fieldbus process data group, define the first 8 bits of this status word. The options for these bits are based off the standard relay functions.			
M4.4	FB PI setpoint 1			ID 2542
Minimum value:	Varies	Maximum value:	PID1_ProcessUnit Max	Default value: Varies.
Description:	PID setpoint 1 value from fieldbus.			
M4.5	FB PI setpoint 2			ID 2544
Minimum value:	PID1_ProcessUnitMin	Maximum value:	PID1_ProcessUnit Max	Default value: Varies.
Description:	PID setpoint 2 value from fieldbus.			

Table 53. Monitor (Cont.).

M4.6	<i>FB PI feedback</i>			ID 2550
Minimum value:	% varies	Maximum value:	% varies	Default value: % varies.
Description:	PID feedback 1 value from fieldbus.			
M5 - PI monitor.				
M5.1	<i>PI set point</i>			ID 16
Minimum value:	Varies	Maximum value:	Varies	Default value: Varies
Description:	PI set point in process units.			
M5.2	<i>PI feedback</i>			ID 18
Minimum value:	Varies	Maximum value:	Varies	Default value: Varies
Description:	PI feedback level in process units.			
M5.3	<i>PI error value</i>			ID 20
Minimum value:	Varies	Maximum value:	Varies	Default value: Varies
Description:	PI error in process units.			
M5.4	<i>PI output</i>			ID 22
Minimum value:	%	Maximum value:	%	Default value: %
Description:	PI output.			
M5.5	<i>PI status</i>			ID 23
Minimum value:	N.A.	Maximum value:	N.A.	Default value: N.A.
Options:	0 = Stopped; 1 = Running; or 2 = Sleep mode.			
Description:	PI status indication, indicates if drive is stopped, running in PI mode, or in PI sleep mode.			
M6 - User defined scale.				
M6.1	<i>Output</i>			ID 2445
Minimum value:	Varies	Maximum value:	Varies	Default value: Varies
Description:	User defined output value that can be configured with the users desired unit and scale.			
M6.2	<i>Reference</i>			ID 2447
Minimum value:	Varies	Maximum value:	Varies	Default value: Varies
Description:	User defined reference value that can be configured with the users desired unit and scale.			

Table 54. Multi-pump status .

M7.1 - Operation mode.				
M7.1.1	<i>Drive 1</i>			ID 2218
Minimum value:	N.A.	Maximum value:	N.A.	Default value: N.A.
Options:	0 = Offline; 1 = Slave drive; 2 = Master drive; or 3 = Redundant drive.			
Description:	Provides the operating mode of drive 1 while using multi-pump mode.			

Table 54. Multi-pump status (Cont.).

M7.1.2	Drive 2				ID 2230
Minimum value:	N.A.	Maximum value:	N.A.	Default value:	N.A.
Options:	0 = Offline; 1 = Slave drive; 2 = Master drive; or 3 = Redundant drive.				
Description:	Provides the operating mode of drive 2 while using multi-pump mode.				
M7.1.3	Drive 3				ID 2242
Minimum value:	N.A.	Maximum value:	N.A.	Default value:	N.A.
Options:	0 = Offline; 1 = Slave drive; 2 = Master drive; or 3 = Redundant drive.				
Description:	Provides the operating mode of drive 3 while using multi-pump mode.				
M7.1.4	Drive 4				ID 2254
Minimum value:	N.A.	Maximum value:	N.A.	Default value:	N.A.
Options:	0 = Offline; 1 = Slave drive; 2 = Master drive; or 3 = Redundant drive.				
Description:	Provides the operating mode of drive 4 while using multi-pump mode.				
M7.1.5	Drive 5				ID 2266
Minimum value:	N.A.	Maximum value:	N.A.	Default value:	N.A.
Options:	0 = Offline; 1 = Slave drive; 2 = Master drive; or 3 = Redundant drive.				
Description:	Provides the operating mode of drive 5 while using multi-pump mode.				
M7.2 - Multi-pump status.					
M7.2.1	Drive 1				ID 2219
Minimum value:	N.A.	Maximum value:	N.A.	Default value:	5
Options:	0 = Stopped; 1 = Sleep; 2 = Regulating; 3 = Wait for CMD 4 = Following; or 5 = Unknown.				
Description:	Provides the run status of drive 1 while using the multi-pump mode.				
M7.2.2	Drive 2				ID 2231
Minimum value:	N.A.	Maximum value:	N.A.	Default value:	5
Options:	0 = Stopped; 1 = Sleep; 2 = Regulating; 3 = Wait for CMD 4 = Following; or 5 = Unknown.				
Description:	Provides the run status of drive 2 while using the multi-pump mode.				

Table 54. Multi-pump status (Cont.).

M7.2.3	Drive 3				ID 2243
Minimum value:	N.A.	Maximum value:	N.A.	Default value:	5
Options:	0 = Stopped; 1 = Sleep; 2 = Regulating; 3 = Wait for CMD 4 = Following; or 5 = Unknown.				
Description:	Provides the run status of drive 3 while using the multi-pump mode.				
M7.2.4	Drive 4				ID 2255
Minimum value:	N.A.	Maximum value:	N.A.	Default value:	5
Options:	0 = Stopped; 1 = Sleep; 2 = Regulating; 3 = Wait for CMD 4 = Following; or 5 = Unknown.				
Description:	Provides the run status of drive 4 while using the multi-pump mode.				
M7.2.5	Drive 5				ID 2267
Minimum value:	N.A.	Maximum value:	N.A.	Default value:	5
Options:	0 = Stopped; 1 = Sleep; 2 = Regulating; 3 = Wait for CMD 4 = Following; or 5 = Unknown.				
Description:	Provides the run status of drive 5 while using the multi-pump mode.				
M7.3 - Network status.					
M7.3.1	Drive 1				ID 2220
Minimum value:	N.A.	Maximum value:	N.A.	Default value:	N.A.
Options:	0 = Disconnected; 1 = Fault; 2 = Pump lost; 3 = Need alternation; or 4 = No error.				
Description:	Provides the network status of drive 1 while using the multi-pump mode.				
M7.3.2	Drive 2				ID 2232
Minimum value:	N.A.	Maximum value:	N.A.	Default value:	N.A.
Options:	0 = Disconnected; 1 = Fault; 2 = Pump lost; 3 = Need alternation; or 4 = No error.				
Description:	Provides the network status of drive 2 while using the multi-pump mode.				
M7.3.3	Drive 3				ID 2244
Minimum value:	N.A.	Maximum value:	N.A.	Default value:	N.A.
Options:	0 = Disconnected; 1 = Fault; 2 = Pump lost; 3 = Need alternation; or 4 = No error.				
Description:	Provides the network status of drive 3 while using the multi-pump mode.				

Table 54. Multi-pump status (Cont.).

M7.3.4	Drive 4				ID 2256
Minimum value:	N.A.	Maximum value:	N.A.	Default value:	N.A.
Options:	0 = Disconnected; 1 = Fault; 2 = Pump lost; 3 = Need alternation; or 4 = No error.				
Description:	Provides the network status of drive 4 while using the multi-pump mode.				
M7.3.5	Drive 5				ID 2268
Minimum value:	N.A.	Maximum value:	N.A.	Default value:	N.A.
Options:	0 = Disconnected; 1 = Fault; 2 = Pump lost; 3 = Need alternation; or 4 = No error.				
Description:	Provides the network status of drive 5 while using the multi-pump mode.				

Table 55. Multi-pump measurement.

M8.1 - Latest fault code.					
M8.1.1	Drive 1				ID 2221
Minimum value:		Maximum value:		Default value:	
Description:	Provides the latest fault code of drive 1 while using the multi-pump mode.				
M8.1.2	Drive 2				ID 2233
Minimum value:		Maximum value:		Default value:	
Description:	Provides the latest fault code of drive 2 while using the multi-pump mode.				
M8.1.3	Drive 3				ID 2245
Minimum value:		Maximum value:		Default value:	
Description:	Provides the latest fault code of drive 3 while using the multi-pump mode.				
M8.1.4	Drive 4				ID 2257
Minimum value:		Maximum value:		Default value:	
Description:	Provides the latest fault code of drive 4 while using the multi-pump mode.				
M8.1.5	Drive 5				ID 2269
Minimum value:		Maximum value:		Default value:	
Description:	Provides the latest fault code of drive 5 while using the multi-pump mode.				
M8.2 - Output frequency.					
M8.2.1	Drive 1				ID 2222
Minimum value:	Hz	Maximum value:	Hz	Default value:	Hz
Description:	Provides the output frequency (Hz) of drive 1 while using the multi-pump mode.				
M8.2.2	Drive 2				ID 2234
Minimum value:	Hz	Maximum value:	Hz	Default value:	Hz
Description:	Provides the output frequency (Hz) of drive 2 while using the multi-pump mode.				
M8.2.3	Drive 3				ID 2246
Minimum value:	Hz	Maximum value:	Hz	Default value:	Hz
Description:	Provides the output frequency (Hz) of drive 3 while using the multi-pump mode.				

Table 55. Multi-pump measurement (Cont.).

M8.2.4	Drive 4			ID 2258
Minimum value:	Hz	Maximum value:	Hz	Default value: Hz
Description:	Provides the output frequency (Hz) of drive 4 while using the multi-pump mode.			
M8.2.5	Drive 5			ID 2270
Minimum value:	Hz	Maximum value:	Hz	Default value: Hz
Description:	Provides the output frequency (Hz) of drive 5 while using the multi-pump mode.			
M8.3 - Motor voltage.				
M8.3.1	Drive 1			ID 2223
Minimum value:	V	Maximum value:	V	Default value: V
Description:	Provides the motor voltage (Vac) of drive 1 while using the multi-pump mode.			
M8.3.2	Drive 2			ID 2235
Minimum value:	V	Maximum value:	V	Default value: V
Description:	Provides the motor voltage (Vac) of drive 2 while using the multi-pump mode.			
M8.3.3	Drive 3			ID 2247
Minimum value:	V	Maximum value:	V	Default value: V
Description:	Provides the motor voltage (Vac) of drive 3 while using the multi-pump mode.			
M8.3.4	Drive 4			ID 2259
Minimum value:	V	Maximum value:	V	Default value: V
Description:	Provides the motor voltage (Vac) of drive 4 while using the multi-pump mode.			
M8.3.5	Drive 5			ID 2271
Minimum value:	V	Maximum value:	V	Default value: V
Description:	Provides the motor voltage (Vac) of drive 5 while using the multi-pump mode.			
M8.4 - Motor current.				
M8.4.1	Drive 1			ID 2224
Minimum value:	A	Maximum value:	A	Default value: A
Description:	Provides the motor current (Amps) of drive 1 while using the multi-pump mode.			
M8.4.2	Drive 2			ID 2236
Minimum value:	A	Maximum value:	A	Default value: A
Description:	Provides the motor current (Amps) of drive 2 while using the multi-pump mode.			
M8.4.3	Drive 3			ID 2248
Minimum value:	A	Maximum value:	A	Default value: A
Description:	Provides the motor current (Amps) of drive 3 while using the multi-pump mode.			
M8.4.4	Drive 4			ID 2260
Minimum value:	A	Maximum value:	A	Default value: A
Description:	Provides the motor current (Amps) of drive 4 while using the multi-pump mode.			
M8.4.5	Drive 5			ID 2272
Minimum value:	A	Maximum value:	A	Default value: A
Description:	Provides the motor current (Amps) of drive 5 while using the multi-pump mode.			

Table 55. Multi-pump measurement (Cont.).

M8.5 - Motor torque.					
M8.5.1	Drive 1				ID 2225
Minimum value:	%	Maximum value:	%	Default value:	%
Description:	Provides the motor torque (%) of drive 1 while using the multi-pump mode.				
M8.5.2	Drive 2				ID 2237
Minimum value:	%	Maximum value:	%	Default value:	%
Description:	Provides the motor torque (%) of drive 2 while using the multi-pump mode.				
M8.5.3	Drive 3				ID 2249
Minimum value:	%	Maximum value:	%	Default value:	%
Description:	Provides the motor torque (%) of drive 3 while using the multi-pump mode.				
M8.5.4	Drive 4				ID 2261
Minimum value:	%	Maximum value:	%	Default value:	%
Description:	Provides the motor torque (%) of drive 4 while using the multi-pump mode.				
M8.5.5	Drive 5				ID 2273
Minimum value:	%	Maximum value:	%	Default value:	%
Description:	Provides the motor torque (%) of drive 5 while using the multi-pump mode.				
M8.6 - Motor power.					
M8.6.1	Drive 1				ID 2226
Minimum value:	%	Maximum value:	%	Default value:	%
Description:	Provides the motor power (%) of drive 1 while using the multi-pump mode.				
M8.6.2	Drive 2				ID 2238
Minimum value:	%	Maximum value:	%	Default value:	%
Description:	Provides the motor power (%) of drive 2 while using the multi-pump mode.				
M8.6.3	Drive 3				ID 2250
Minimum value:	%	Maximum value:	%	Default value:	%
Description:	Provides the motor power (%) of drive 3 while using the multi-pump mode.				
M8.6.4	Drive 4				ID 2262
Minimum value:	%	Maximum value:	%	Default value:	%
Description:	Provides the motor power (%) of drive 4 while using the multi-pump mode.				
M8.6.5	Drive 5				ID 2274
Minimum value:	%	Maximum value:	%	Default value:	%
Description:	Provides the motor power (%) of drive 5 while using the multi-pump mode.				
M8.7 - Motor speed.					
M8.7.1	Drive 1				ID 2227
Minimum value:	rpm	Maximum value:	rpm	Default value:	rpm
Description:	Provides the motor speed (rpm) of drive 1 while using the multi-pump mode.				
M8.7.2	Drive 2				ID 2239
Minimum value:	rpm	Maximum value:	rpm	Default value:	rpm
Description:	Provides the motor speed (rpm) of drive 2 while using the multi-pump mode.				
M8.7.3	Drive 3				ID 2251
Minimum value:	rpm	Maximum value:	rpm	Default value:	rpm
Description:	Provides the motor speed (rpm) of drive 3 while using the multi-pump mode.				

Chapter 7- Multi-purpose application

Table 55. Multi-pump measurement (Cont.).

M8.7.4	Drive 4			ID 2263
Minimum value:	rpm	Maximum value:	rpm	Default value: rpm
Description:	Provides the motor speed (rpm) of drive 4 while using the multi-pump mode.			
M8.7.5	Drive 5			ID 2275
Minimum value:	rpm	Maximum value:	rpm	Default value: rpm
Description:	Provides the motor speed (rpm) of drive 5 while using the multi-pump mode.			
M8.8 - Run time.				
M8.8.1	Drive 1			ID 2228
Minimum value:	Hours	Maximum value:	Hours	Default value: Hours
Description:	Provides the motor run time (h) of drive 1 while using the multi-pump mode.			
M8.8.2	Drive 2			ID 2240
Minimum value:	Hours	Maximum value:	Hours	Default value: Hours
Description:	Provides the motor run time (h) of drive 2 while using the multi-pump mode.			
M8.8.3	Drive 3			ID 2252
Minimum value:	Hours	Maximum value:	Hours	Default value: Hours
Description:	Provides the motor run time (h) of drive 3 while using the multi-pump mode.			
M8.8.4	Drive 4			ID 2264
Minimum value:	Hours	Maximum value:	Hours	Default value: Hours
Description:	Provides the motor run time (h) of drive 4 while using the multi-pump mode.			
M8.8.5	Drive 5			ID 2276
Minimum value:	Hours	Maximum value:	Hours	Default value: Hours
Description:	Provides the motor run time (h) of drive 5 while using the multi-pump mode.			
M9 - Multi-monitoring.				
M9.1	Multi-monitoring			ID 30
Minimum value:	N.A.	Maximum value:	N.A.	Default value: 0, 1, 2.
Description:	Displays any three monitoring values in a single screen. The values are selectable via the keypad menu. Multi-monitor page could see three lines of monitoring values. Up and down keys can be used to select the row and then hitting the left arrow key will allow for editing the value then by going up and down.			

Table 56. Parameters.

P1 - Basic parameters.				
P1.1²	Minimum frequency			ID 101
Minimum value:	0.00 Hz	Maximum value:	400.00 Hz	Default value: 0.00 Hz
Description:	Defines the lowest frequency at which the drive will operate. This setting will limit other frequency parameter settings. 1 = Fire mode minimum frequency. 2 = Derag. 3 = MPFC staging frequency. 4 = MPFC master fixed frequency. 5 = Prime pump frequency. 6 = Prime pump frequency 2.			

Table 56. Parameters (Cont.).

P1.2^②	Maximum frequency			ID 102
Minimum value:	0.00 Hz	Maximum value:	400.00 Hz	Default value: MaxFreqMFG
Description:	Defines the highest frequency at which the drive will operate. This will limit other frequency parameters. 1 = Keypad reference. 2 = Motor potentiometer. 3 = Jog speed. 4 = 2nd stage ramp frequency. 5 = Fire mode minimum frequency. 6 = Derag. 7 = MPFC staging frequency. 8 = MPFC master fixed frequency. 9 = Prime pump frequency. 10 = Prime pump frequency 2. 11 = Preset speed frequency. 12 = Frequency limit value. 13 = Reference limit value. 14 = Speed control_fs2. 15 = Stall frequency limit. 16 = 4 mA fault frequency. 17 = MPFC de-staging frequency. 18 = Pipe fill loss frequency low. 19 = Pipe fill loss frequency high. 20 = Broken pipe frequency limit.			
P1.3^②	Accel. time 1			ID 103
Minimum value:	0.1 s	Maximum value:	3,000.0 s	Default value: 20.0 s
Description:	Defines the time required for the output frequency to accelerate from zero frequency to maximum frequency.			
P1.4^②	Decel. time 1			ID 104
Minimum value:	0.1 s	Maximum value:	3,000.0 s	Default value: 20.0 s
Description:	Defines the time required for the output frequency to decelerate from maximum frequency to zero frequency.			
P1.5^②	Motor type selection			ID 1820
Minimum value:	N.A.	Maximum value:	N.A.	Default value: 0
Options:	0 = Inverter duty; 1 = IPM; or 2 = SPM.			
Description:	Defines the type of motor connected to the drive: standard induction motor, internally mounted permanent magnet, or surface mount permanent magnet.			
P1.6^①	Motor nom. current			ID 486
Minimum value:	DriveNomCurrCT*1/10 A	Maximum value:	DriveNomCurrCT*2 A	Default value: DriveNomCurrCT A
Description:	Motor nameplate rated full load current. This value is found on the rating plate of the motor.			
P1.7^①	Motor nom. speed			ID 489
Minimum value:	300 rpm	Maximum value:	20,000 rpm	Default value: MotorNomSpeedMFG
Description:	Motor nameplate rated speed. This value is found on the rating plate of the motor.			
P1.8^①	Motor PF			ID 490
Minimum value:	0.30	Maximum value:	1.00	Default value: 0.85
Description:	Motor nameplate rated power factor. This value is found on the rating plate of the motor.			
P1.9^①	Motor nom. voltage			ID 487
Minimum value:	180 V	Maximum value:	690 V	Default value: MotorNomVoltMFG V
Description:	Motor nameplate rated voltage. This value is found on the rating plate of the motor.			
P1.10^①	Motor nom. frequency			ID 488
Minimum value:	8.00 Hz	Maximum value:	400.00 Hz	Default value: MotorNomFreqMFG Hz
Description:	Motor nameplate rated frequency. This value is found on the rating plate of the motor.			

Chapter 7- Multi-purpose application

Table 56. Parameters (Cont.).

P1.11^②	Local control place			ID 1695
Minimum value:	N.A.	Maximum value:	N.A.	Default value: 0
Options:	0 = keypad; 1 = I/O terminal; or 3 = fieldbus.			
Description:	Defines the signal location for the start command in local mode. I/O terminals would be from the digital hard-wired inputs or keypad for Start/Stop buttons on the drive. Keypad display will indicate which mode is selected.			
P1.12^{①②}	Local reference			ID 136
Minimum value:	N.A.	Maximum value:	N.A.	Default value: 1
Options:	0 = AI; 1 = Drive reference pot; 2 = AI joystick; 3 = Motor pot; 4 = Maximum frequency; 5 = PI control output; 6 = Keypad; or 7 = Fieldbus reference.			
Description:	Defines the signal location for the speed reference in local mode.			
P1.13^②	Remote control place			ID 135
Minimum value:	N.A.	Maximum value:	N.A.	Default value: 0
Options:	0 = I/O terminal; 1 = fieldbus; or 3 = keypad.			
Description:	Defines the signal location for the start command in remote mode. I/O terminals would be from the digital hard-wired inputs or keypad for Start/Stop buttons on the drive. Keypad display will indicate which mode is selected.			
P1.14^{①②}	Remote reference			ID 137
Minimum value:	N.A.	Maximum value:	N.A.	Default value: 0
Options:	0 = AI; 1 = Drive reference pot; 2 = AI joystick; 3 = Motor pot; 4 = Maximum frequency; 5 = PI control output; 6 = Keypad; or 7 = Fieldbus reference.			
Description:	Defines the signal location for the speed reference in remote mode.			

Table 57. Inputs .

P2.1 - Basic settings.				
P2.1.1^②	AI reference scale minimum value			ID 144
Minimum value:	0.00 Hz	Maximum value:	MaxFreq Hz	Default value: 0.00 Hz
Description:	Defines the minimum frequency associated with 0% input from the analog input. Setting AI ref scale minimum value and AI reference scale maximum value both to zero will cause the analog input to scale to the minimum and maximum frequencies.			

Table 57. Inputs (Cont.).

P2.1.2^②	AI reference scale maximum value			ID 145
Minimum value:	RefScaleMin Hz	Maximum value:	400.00 Hz	Default value: 0.00 Hz

Description: Defines the maximum frequency associated with 100% input from the analog input. Setting AI reference scale minimum value and AI reference scale maximum value both to zero will cause the analog input to scale to the minimum and maximum frequencies.

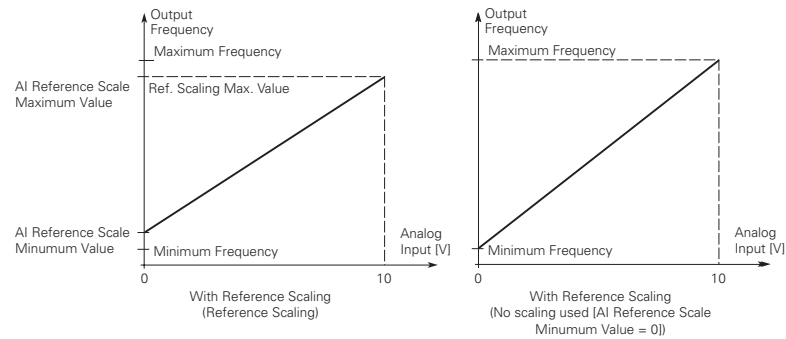

P2.1.3^{①②}	IO terminal Start/Stop logic			ID 143
Minimum value:	N.A.	Maximum value:	N.A.	Default value: 0

Options:
 0 = Forward - reverse: maintained input on start signal 1 to run forward and a maintained signal on start signal 2 for reverse.
 1 = Start - reverse: maintained input on start signal 1 to run forward and a maintained signal on start signal 2 for reverse.
 2 = Start - enable: maintained input on start signal 1 to run forward and a maintained signal on start signal 2 to enable the drive to run.
 3 = Start pulse - stop pulse: used for three-wire operation, start signal 1 uses a normally open start and start signal 2 uses a normally closed stop.

Description: Defines the functionality for start signal 1 and start signal 2. By default, start signal 1 is DI1 and start signal 2 is DI2.
 0 = P3.2: IO terminal start signal 1 = start forward - P3.3: IO terminal start signal 2 = start reverse. This would be considered 2-wire control with either a contact used on the start FWD or start REV commands. When contacts open, the motor stops.

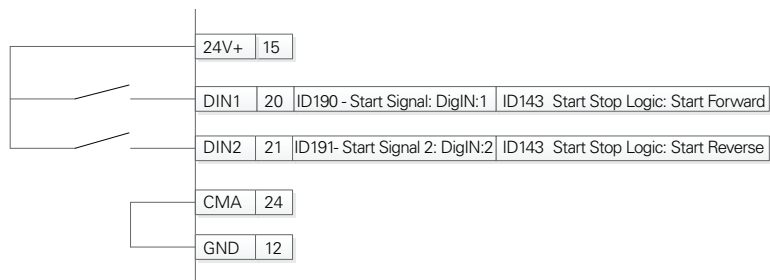
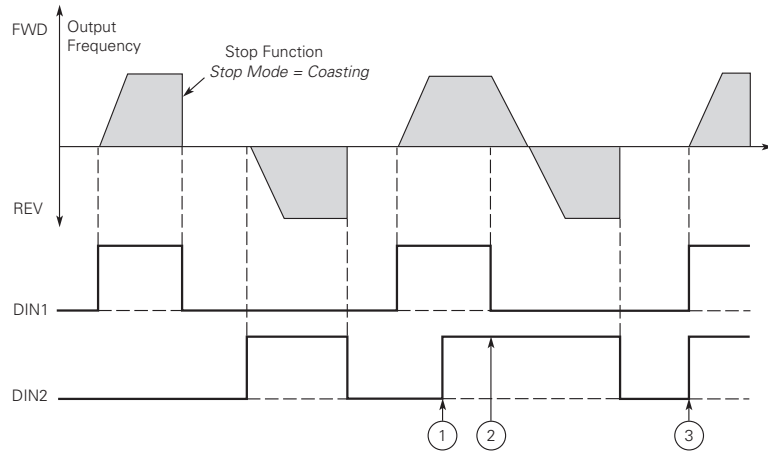

Table 57. Inputs (Cont.).



- Notes:**
- ① The first selected direction has the highest priority.
 - ② When the DIN1 contact opens the direction of rotation starts to change.
 - ③ If start forward (DIN1) and start reverse (DIN2) signals are active simultaneously the start forward signal (DIN1) has priority.

1 = P3.2: IO terminal start signal 1 = start forward - P3.3: IO terminal start signal 2 = start reverse. This would be considered 2-wire control with a contact on start/stop, contact open it stops and direction on 2nd start signal.

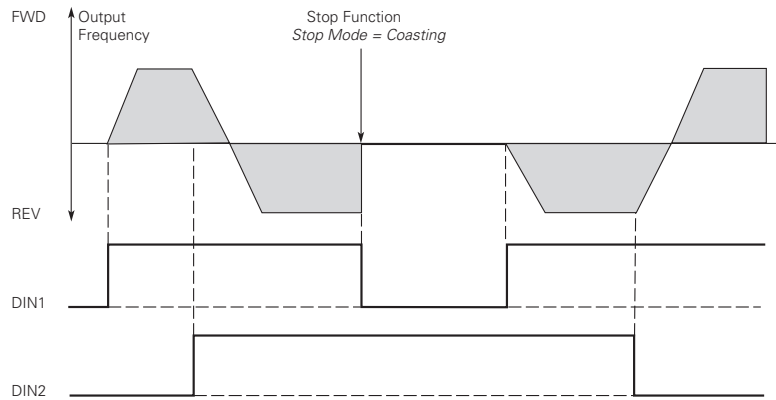
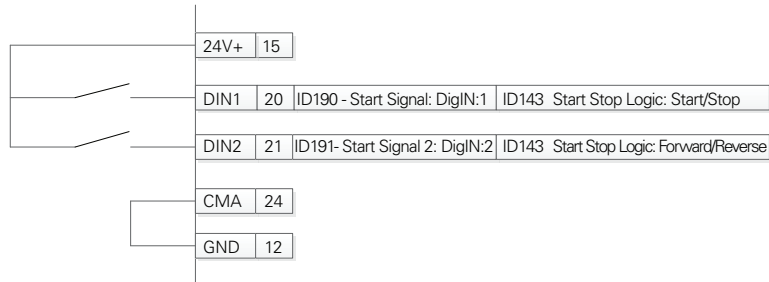
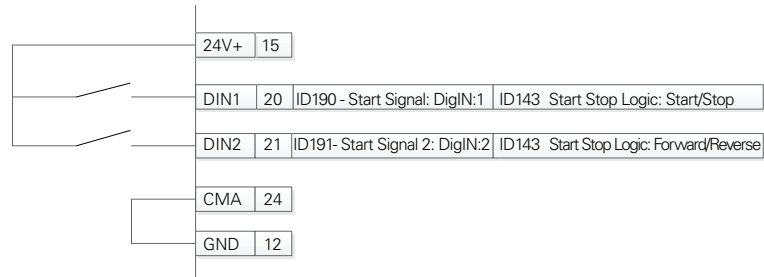
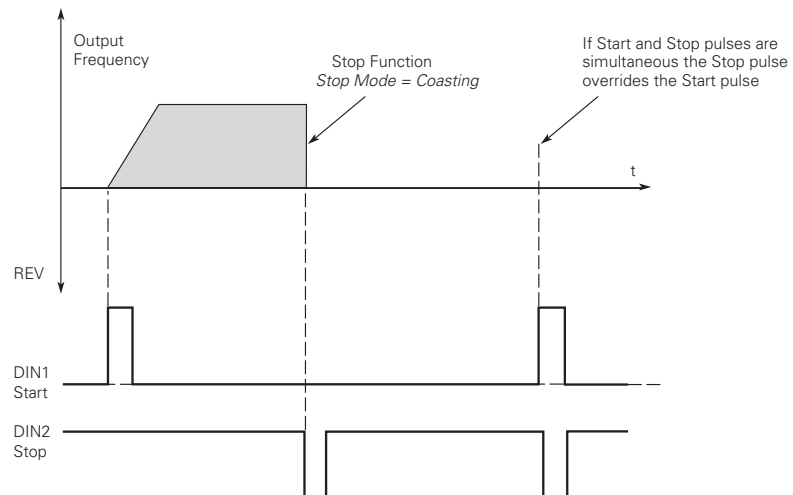
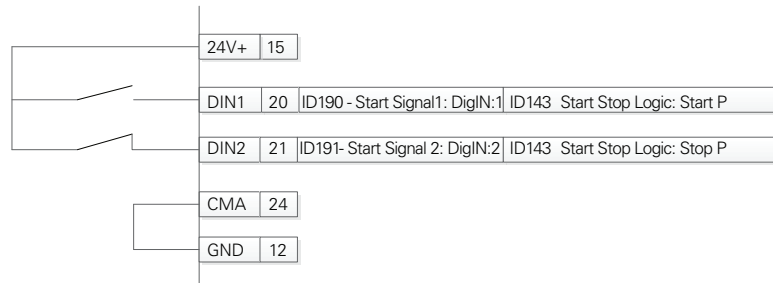

Table 57. Inputs (Cont.).

2 = P3.2: IO terminal start signal 1 = start forward - P3.3: IO terminal start signal 2 = start reverse. This would be considered 3-wire control with start signal 2 required to be closed to enable start on start signal 1.



3 = Three-wire connection (pulse control): P3.2: IO terminal start signal 1 = start forward - P3.3: IO terminal start signal 2 = start reverse. This would be considered 3-wire control with start signal 1 being the start pulse and start signal 2 being the NC stop.



Chapter 7- Multi-purpose application

Table 57. Inputs (Cont.).

P2.1.4^②	External fault 1 text			ID 2227
Minimum value:	N.A.	Maximum value:	N.A.	Default value: 0
Options:	0 = External fault; 1 = Vibration cutout; 2 = High motor temperature; 3 = Low pressure; 4 = High pressure; 5 = Low water; 6 = Damper interlock; 7 = Run enable; 8 = Freeze stat trip; 9 = Smoke detect; 10 = Seal leakage; 11 = Rod breakage; or 12 = Belt break.			
Description:	Defines the text to be displayed when external fault 1 NO or NC is triggered. This text will be viewable using a remote keypad, PowerXpert inControl, or the built in web server.			
P2.1.5^②	External fault 2 text			ID 2298
Minimum value:	N.A.	Maximum value:	N.A.	Default value: 1
Options:	0 = External fault; 1 = Vibration cutout; 2 = High motor temperature; 3 = Low pressure; 4 = High pressure; 5 = Low water; 6 = Damper interlock; 7 = Run enable; 8 = Freeze stat trip; 9 = Smoke detect; 10 = Seal leakage; 11 = Rod breakage; or 12 = Belt break.			
Description:	Defines the text to be displayed when external fault 2 NO or NC is triggered. This text will be viewable using a remote keypad, PowerXpert inControl, or the built in webserver.			
P2.1.6^②	External fault 3 text			ID 2299
Minimum value:	N.A.	Maximum value:	N.A.	Default value: 2
Options:	0 = External fault; 1 = Vibration cutout; 2 = High motor temperature; 3 = Low pressure; 4 = High pressure; 5 = Low water; 6 = Damper interlock; 7 = Run enable; 8 = Freeze stat trip; 9 = Smoke detect; 10 = Seal leakage; 11 = Rod breakage; or 12 = Belt break.			
Description:	Defines the text to be displayed when external fault 3 NO or NC is triggered. This text will be viewable using a remote keypad, PowerXpert inControl, or the built in webserver.			
P2.1.7^②	Motor pot ramp time			ID 156
Minimum value:	0.1 Hz/s	Maximum value:	2,000.0 Hz/s	Default value: 10.0 Hz/s
Description:	Defines the speed of change for the motor potentiometer reference value.			
P2.1.8^②	Motor pot reference reset			ID 169
Minimum value:	N.A.	Maximum value:	N.A.	Default value: 0
Options:	0 = No reset - reference stays at last setting; 1 = Memory reset in stop and power down - reference resets to 0 when drive is stopped or the power is cycled to the drive; or 2 = Memory reset in power down - reference resets to 0 when drive is powered down only.			
Description:	Defines how the motor pot reference signal is handled on shutting down frequency converter output or powering down the frequency converter.			

Table 57. Inputs (Cont.).

P2.2 - Digital input.					
P2.2.1[Ⓢ]	DI1 function				ID 1801
Minimum value:	N.A.	Maximum value:	N.A.	Default value:	1
Options:	0 = Not used, no action. 1 = IO terminal start signal 1, when the control source is set to IO terminal, this input when closed will perform the action defined by P2.1.3. 2 = IO terminal start signal 2, when the control source is set to IO terminal, this input when closed will perform the action defined by P2.1.3. 3 = Reverse, when Start/Stop logic is set to 3 start pulse stop pulse, this input will cause the drive to start in the reverse direction. 4 = Ext. fault 1, when closed, Ext. fault 1 will be activated. 5 = Ext. fault 2, when closed, Ext. fault 2 will be activated. 6 = Ext. fault 3, when closed, Ext. fault 3 will be activated. 7 = Fault reset, when closed all active faults will be reset. 8 = Run enable, when closed, the drive will allow a start command and be in the ready state. 9 = Preset speed B0, the seven preset speeds are selected via three binary inputs. This is least significant bit in that binary input. 10 = Preset speed B1, the seven preset speeds are selected via three binary inputs. 11 = Preset speed B2, the seven preset speeds are selected via three binary inputs. This is most significant bit in that binary input. 12 = Jog enable, when closed, the jog speed defined at P2.3.8 will override the frequency reference. 13 = Accel. pot value, when closed, the motor potentiometer value will increment at the rate defined by motor pot ramp time. 14 = Decel. pot value, when closed, the motor potentiometer value will decrement at the rate defined by motor pot ramp time. 15 = Reset pot zero, when closed, the motor potentiometer value will reset to zero. 16 = Accel./Decel. time set, when open, Accel./Decel. time 1 will be used. When closed, Accel./Decel. time 2 will be used. 17 = Accel./Decel. prohibit, when closed, the drive will hold the output frequency and ignore changes to the reference value. 18 = No access to param., when closed, no changes can be made to any setting in the drive. 19 = Remote control, when closed, the drive will be forced to the remote control place. 20 = Local control, when closed, the drive will be forced to the local control place. 21 = Parameter 1/2 Sel., when open, parameter set 1 is active. When closed, parameter set 2 is active. 22 = PI controller, when closed, the drive will force the reference source to PI controller output. 23 = PI setpoint select, when open, parameter setpoint 1 is active. When closed setpoint 2 is active. 24 = Motor interlock 1, when closed, motor will be enabled to run. 25 = Smoke mode, when closed, smoke mode will be active. 26 = Fire mode, when closed, the fire mode will be active. 27 = Fire mode Ref. 1/2 select, when fire mode is active and this input is open, fire mode Ref. 1 will be active. When closed, fire mode Ref. 2 will be active. 28 = Fire mode reverse, when fire mode is active and this input is open, the direction will be forward. When closed, the direction will be reverse. 29 = DC brake active, when closed, DC injection braking will be active. 30 = Preheat active, when closed, the preheat mode will be active. 31 = Derag. enable, when closed, the Derag. cycle for pumps will be initiated.				
Description:	Defines the function of digital input 1.				
P2.2.2[Ⓢ]	DI1 invert				ID 1802
Minimum value:	N.A.	Maximum value:	N.A.	Default value:	0
Options:	0 = Disabled; or 1 = Enabled.				
Description:	When enabled, the function assigned to DI1 will be activated with the opposite state of DI1.				

Table 57. Inputs (Cont.).

P2.2.3^②	DI2 function				ID 1803
Minimum value:	N.A.	Maximum value:	N.A.	Default value:	2
Options:	0 = Not used, no action. 1 = IO terminal start signal 1, when the control source is set to IO terminal, this input when closed will perform the action defined by P2.1.3. 2 = IO terminal start signal 2, when the control source is set to IO terminal, this input when closed will perform the action defined by P2.1.3. 3 = Reverse, when Start/Stop logic is set to three start pulse stop pulse, this input will cause the drive to start in the reverse direction. 4 = Ext. fault 1, when closed, Ext. fault 1 will be activated. 5 = Ext. fault 2, when closed, Ext. fault 2 will be activated. 6 = Ext. fault 3, when closed, Ext. fault 3 will be activated. 7 = Fault reset, when closed, all active faults will be reset. 8 = Run enable, when closed, the drive will allow a start command and be in the ready state. 9 = Preset speed B0, the seven preset speeds are selected via three binary inputs. This is least significant bit in that binary input. 10 = Preset speed B1, the seven preset speeds are selected via three binary inputs. 11 = Preset speed B2, the seven preset speeds are selected via three binary inputs. This is most significant bit in that binary input. 12 = Jog enable, when closed, the jog speed defined at P2.3.8 will override the frequency reference. 13 = Accel. pot value, when closed, the motor potentiometer value will increment at the rate defined by motor pot ramp time. 14 = Decel. pot value, when closed, the motor potentiometer value will decrement at the rate defined by motor pot ramp time. 15 = Reset pot zero, when closed, the motor potentiometer value will reset to zero. 16 = Accel./decel. time set, when open, accel./decel. time 1 will be used. When closed, accel./decel. time 2 will be used. 17 = Accel./decel. prohibit, when closed, the drive will hold the output frequency and ignore changes to the reference value. 18 = No access to param., when closed, no changes can be made to any setting in the drive. 19 = Remote control, when closed, the drive will be forced to the remote control place. 20 = Local control, when closed, the drive will be forced to the local control place. 21 = Parameter 1/2 Sel., when open, parameter set 1 is active. When closed, Parameter set 2 is active. 22 = PI controller, when closed, the drive will force the reference source to PI controller output. 23 = PI setpoint select, when open, parameter setpoint 1 is active. When closed, setpoint 2 is active. 24 = Motor interlock 1, when closed, the motor will be enabled to run. 25 = Smoke mode, when closed, smoke mode will be active. 26 = Fire mode, when closed, fire mode will be active. 27 = Fire mode Ref. 1/2 Sel., when fire mode is active and this input is open, fire mode Ref. 1 will be active. When closed, fire mode Ref. 2 will be active. 28 = Fire mode reverse, when fire mode is active and this input is open, the direction will be forward. When closed, the direction will be reverse. 29 = DC brake active, when closed, DC injection braking will be active. 30 = Preheat active, when closed, preheat mode will be active. 31 = Derag. enable, when closed, the Derag. cycle for pumps will be initiated.				
Description:	Defines the function of digital input 2.				
P2.2.4^②	DI2 invert				ID 1804
Minimum value:	N.A.	Maximum value:	N.A.	Default value:	0
Options:	0 = Disable; or 1 = Enable.				
Description:	When enabled, the function assigned to DI2 will be activated with the opposite state of DI2.				

Table 57. Inputs (Cont.).

P2.2.5^②	DI3 function			ID 1805
Minimum value:	N.A.	Maximum value:	N.A.	Default value: 4
Options:	<p>0 = Not used, no action. 1 = IO terminal start signal 1, when the control source is set to IO terminal, this input when closed will perform the action defined by P2.1.3. 2 = IO terminal start signal 2, when the control source is set to IO terminal, this input when closed will perform the action defined by P2.1.3. 3 = Reverse, when Start/Stop logic is set to three start pulse stop pulse, this input will cause the drive to start in the reverse direction. 4 = Ext. fault 1, when closed, Ext. fault 1 will be activated. 5 = Ext. fault 2, when closed, Ext. fault 2 will be activated. 6 = Ext. fault 3, when closed, Ext. fault 3 will be activated. 7 = Fault reset, when closed, all active faults will be reset. 8 = Run enable, when closed, the drive will allow a start command and be in the ready state. 9 = Preset speed B0, the seven preset speeds are selected via three binary inputs. This is least significant bit in that binary input. 10 = Preset speed B1, the seven preset speeds are selected via three binary inputs. 11 = Preset speed B2, the seven preset speeds are selected via three binary inputs. This is most significant bit in that binary input. 12 = Jog enable, when closed, the jog speed defined at P2.3.8 will override the frequency reference. 13 = Accel. pot value, when closed, the motor potentiometer value will increment at the rate defined by motor pot ramp time. 14 = Decel. pot value, when closed, the motor potentiometer value will decrement at the rate defined by motor pot ramp time. 15 = Reset pot zero, when closed, the motor potentiometer value will reset to zero. 16 = Accel./decel. time set, when open, accel./decel. time 1 will be used. When closed, accel./decel. time 2 will be used. 17 = Accel./decel. prohibit, when closed, the drive will hold the output frequency and ignore changes to the reference value. 18 = No access to param., when closed, no changes can be made to any setting in the drive. 19 = Remote control, when closed, the drive will be forced to the remote control place. 20 = Local control, when closed, the drive will be forced to the local control place. 21 = Parameter 1/2 Sel., when open, parameter set 1 is active. When closed, Parameter set 2 is active. 22 = PI controller, when closed, the drive will force the reference source to PI controller output. 23 = PI setpoint select, when open, parameter setpoint 1 is active. When closed, setpoint 2 is active. 24 = Motor interlock 1, when closed, the motor will be enabled to run. 25 = Smoke mode, when closed, smoke mode will be active. 26 = Fire mode, when closed, fire mode will be active. 27 = Fire mode Ref. 1/2 Sel., when fire mode is active and this input is open, fire mode Ref. 1 will be active. When closed, fire mode Ref. 2 will be active. 28 = Fire mode reverse, when fire mode is active and this input is open, the direction will be forward. When closed, the direction will be reverse. 29 = DC brake active, when closed, DC injection braking will be active. 30 = Preheat active, when closed, preheat mode will be active. 31 = Derag. enable, when closed, the Derag. cycle for pumps will be initiated.</p>			
Description:	Defines the function of digital input 3.			
P2.2.6^②	DI3 invert			ID 1806
Minimum value:	N.A.	Maximum value:	N.A.	Default value: 0
Options:	<p>0 = Disable; or 1 = Enable.</p>			
Description:	When enabled, the function assigned to DI3 will be activated with the opposite state of DI3.			

Table 57. Inputs (Cont.).

P2.2.7[®]	DI4 function				ID 1807
Minimum value:	N.A.	Maximum value:	N.A.	Default value:	7
Options:	0 = Not used, no action. 1 = IO terminal start signal 1, when the control source is set to IO terminal, this input when closed will perform the action defined by P2.1.3. 2 = IO terminal start signal 3, when the control source is set to IO terminal, this input when closed will perform the action defined by P2.1.3. 3 = Reverse, when Start/Stop logic is set to three start pulse stop pulse, this input will cause the drive to start in the reverse direction. 4 = Ext. fault 1, when closed, Ext. fault 1 will be activated. 5 = Ext. fault 2, when closed, Ext. fault 2 will be activated. 6 = Ext. fault 3, when closed, Ext. fault 3 will be activated. 7 = Fault reset, when closed, all active faults will be reset. 8 = Run enable, when closed, the drive will allow a start command and be in the ready state. 9 = Preset speed B0, the seven preset speeds are selected via three binary inputs. This is least significant bit in that binary input. 10 = Preset speed B1, the seven preset speeds are selected via three binary inputs. 11 = Preset speed B2, the seven preset speeds are selected via three binary inputs. This is most significant bit in that binary input. 12 = Jog enable, when closed, the jog speed defined at P2.3.8 will override the frequency reference. 13 = Accel. pot value, when closed, the motor potentiometer value will increment at the rate defined by motor pot ramp time. 14 = Decel. pot value, when closed, the motor potentiometer value will decrement at the rate defined by motor pot ramp time. 15 = Reset pot zero, when closed, the motor potentiometer value will reset to zero. 16 = Accel./decel. time set, when open, accel./decel. time 1 will be used. When closed, accel./decel. time 2 will be used. 17 = Accel./decel. prohibit, when closed, the drive will hold the output frequency and ignore changes to the reference value. 18 = No access to param., when closed, no changes can be made to any setting in the drive. 19 = Remote control, when closed, the drive will be forced to the remote control place. 20 = Local control, when closed, the drive will be forced to the local control place. 21 = Parameter 1/2 Sel., when open, parameter set 1 is active. When closed, Parameter set 2 is active. 22 = PI controller, when closed, the drive will force the reference source to PI controller output. 23 = PI setpoint select, when open, parameter setpoint 1 is active. When closed, setpoint 2 is active. 24 = Motor interlock 1, when closed, the motor will be enabled to run. 25 = Smoke mode, when closed, smoke mode will be active. 26 = Fire mode, when closed, fire mode will be active. 27 = Fire mode Ref. 1/2 Sel., when fire mode is active and this input is open, fire mode Ref. 1 will be active. When closed, fire mode Ref. 2 will be active. 28 = Fire mode reverse, when fire mode is active and this input is open, the direction will be forward. When closed, the direction will be reverse. 29 = DC brake active, when closed, DC injection braking will be active. 30 = Preheat active, when closed, preheat mode will be active. 31 = Derag. enable, when closed, the Derag. cycle for pumps will be initiated.				
Description:	Defines the function of digital input 4.				
P2.2.8[®]	DI4 invert				ID 1808
Minimum value:	N.A.	Maximum value:	N.A.	Default value:	0
Options:	0 = Disable; or 1 = Enable.				
Description:	When enabled, the function assigned to DI4 will be activated with the opposite state of DI4.				

Table 57. Inputs (Cont.).

P2.2.9[®]	Virtual R01 input	ID 1809
Minimum value:	N.A.	Maximum value: N.A. Default value: 0
Options:	0 = Not used, no action. 1 = IO terminal start signal 1, when the control source is set to IO terminal, this input when closed will perform the action defined by P2.1.3. 2 = IO terminal start signal 3, when the control source is set to IO terminal, this input when closed will perform the action defined by P2.1.3. 3 = Reverse, when Start/Stop logic is set to three start pulse stop pulse, this input will cause the drive to start in the reverse direction. 4 = Ext. fault 1, when closed, Ext. fault 1 will be activated. 5 = Ext. fault 2, when closed, Ext. fault 2 will be activated. 6 = Ext. fault 3, when closed, Ext. fault 3 will be activated. 7 = Fault reset, when closed, all active faults will be reset. 8 = Run enable, when closed, the drive will allow a start command and be in the ready state. 9 = Preset speed B0, the seven preset speeds are selected via three binary inputs. This is least significant bit in that binary input. 10 = Preset speed B1, the seven preset speeds are selected via three binary inputs. 11 = Preset speed B2, the seven preset speeds are selected via three binary inputs. This is most significant bit in that binary input. 12 = Jog enable, when closed, the jog speed defined at P2.3.8 will override the frequency reference. 13 = Accel. pot value, when closed, the motor potentiometer value will increment at the rate defined by motor pot ramp time. 14 = Decel. pot value, when closed, the motor potentiometer value will decrement at the rate defined by motor pot ramp time. 15 = Reset pot zero, when closed, the motor potentiometer value will reset to zero. 16 = Accel./decel. time set, when open, accel./decel. time 1 will be used. When closed, accel./decel. time 2 will be used. 17 = Accel./decel. prohibit, when closed, the drive will hold the output frequency and ignore changes to the reference value. 18 = No access to param., when closed, no changes can be made to any setting in the drive. 19 = Remote control, when closed, the drive will be forced to the remote control place. 20 = Local control, when closed, the drive will be forced to the local control place. 21 = Parameter 1/2 Sel., when open, parameter set 1 is active. When closed, Parameter set 2 is active. 22 = PI controller, when closed, the drive will force the reference source to PI controller output. 23 = PI setpoint select, when open, parameter setpoint 1 is active. When closed, setpoint 2 is active. 24 = Motor interlock 1, when closed, the motor will be enabled to run. 25 = Smoke mode, when closed, smoke mode will be active. 26 = Fire mode, when closed, fire mode will be active. 27 = Fire mode Ref. 1/2 Sel., when fire mode is active and this input is open, fire mode Ref. 1 will be active. When closed, fire mode Ref. 2 will be active. 28 = Fire mode reverse, when fire mode is active and this input is open, the direction will be forward. When closed, the direction will be reverse. 29 = DC brake active, when closed, DC injection braking will be active. 30 = Preheat active, when closed, preheat mode will be active. 31 = Derag. enable, when closed, the Derag. cycle for pumps will be initiated.	
Description:	Defines the function of virtual R01.	
P2.2.10[®]	Virtual R01 invert	ID 1810
Minimum value:	N.A.	Maximum value: N.A. Default value: 0
Options:	0 = Disable; or 1 = Enable.	
Description:	When enabled, the function assigned to virtual R01 input will be activated with the opposite state of virtual R01 input.	

Table 57. Inputs (Cont.).

P2.2.11[Ⓢ]	Virtual R02 input			ID 1811
Minimum value:	N.A.	Maximum value:	N.A.	Default value: 0
Options:	0 = Not used, no action. 1 = IO terminal start signal 1, when the control source is set to IO terminal, this input when closed will perform the action defined by P2.1.3. 2 = IO terminal start signal 3, when the control source is set to IO terminal, this input when closed will perform the action defined by P2.1.3. 3 = Reverse, when Start/Stop logic is set to three start pulse stop pulse, this input will cause the drive to start in the reverse direction. 4 = Ext. fault 1, when closed, Ext. fault 1 will be activated. 5 = Ext. fault 2, when closed, Ext. fault 2 will be activated. 6 = Ext. fault 3, when closed, Ext. fault 3 will be activated. 7 = Fault reset, when closed, all active faults will be reset. 8 = Run enable, when closed, the drive will allow a start command and be in the ready state. 9 = Preset speed B0, the seven preset speeds are selected via three binary inputs. This is least significant bit in that binary input. 10 = Preset speed B1, the seven preset speeds are selected via three binary inputs. 11 = Preset speed B2, the seven preset speeds are selected via three binary inputs. This is most significant bit in that binary input. 12 = Jog enable, when closed, the jog speed defined at P2.3.8 will override the frequency reference. 13 = Accel. pot value, when closed, the motor potentiometer value will increment at the rate defined by motor pot ramp time. 14 = Decel. pot value, when closed, the motor potentiometer value will decrement at the rate defined by motor pot ramp time. 15 = Reset pot zero, when closed, the motor potentiometer value will reset to zero. 16 = Accel./decel. time set, when open, accel./decel. time 1 will be used. When closed, accel./decel. time 2 will be used. 17 = Accel./decel. prohibit, when closed, the drive will hold the output frequency and ignore changes to the reference value. 18 = No access to param., when closed, no changes can be made to any setting in the drive. 19 = Remote control, when closed, the drive will be forced to the remote control place. 20 = Local control, when closed, the drive will be forced to the local control place. 21 = Parameter 1/2 Sel., when open, parameter set 1 is active. When closed, Parameter set 2 is active. 22 = PI controller, when closed, the drive will force the reference source to PI controller output. 23 = PI setpoint select, when open, parameter setpoint 1 is active. When closed, setpoint 2 is active. 24 = Motor interlock 1, when closed, the motor will be enabled to run. 25 = Smoke mode, when closed, smoke mode will be active. 26 = Fire mode, when closed, fire mode will be active. 27 = Fire mode Ref. 1/2 Sel., when fire mode is active and this input is open, fire mode Ref. 1 will be active. When closed, fire mode Ref. 2 will be active. 28 = Fire mode reverse, when fire mode is active and this input is open, the direction will be forward. When closed, the direction will be reverse. 29 = DC brake active, when closed, DC injection braking will be active. 30 = Preheat active, when closed, preheat mode will be active. 31 = Derag. enable, when closed, the Derag. cycle for pumps will be initiated.			
Description:	Defines the function of virtual R02.			
P2.2.12[Ⓢ]	Virtual R02 invert			ID 1810
Minimum value:	N.A.	Maximum value:	N.A.	Default value: 0
Options:	0 = Disable; or 1 = Enable.			
Description:	When enabled, the function assigned to virtual R02 input will be activated with the opposite state of virtual R02 input.			
P2.3 - Preset speed.				
P2.3.1[Ⓢ]	Preset speed 1			ID 105
Minimum value:	0.00 Hz	Maximum value:	MaxFreq Hz	Default value: 5.00 Hz
Description:	Preset speed is selected with digital inputs using a binary input.			
P2.3.2[Ⓢ]	Preset speed 2			ID 106
Minimum value:	0.00 Hz	Maximum value:	MaxFreq Hz	Default value: 10.00 Hz
Description:	Preset speed is selected with digital inputs using a binary input.			
P2.3.3[Ⓢ]	Preset speed 3			ID 118
Minimum value:	0.00 Hz	Maximum value:	MaxFreq Hz	Default value: 15.00 Hz
Description:	Preset speed is selected with digital inputs using a binary input.			
P2.3.4[Ⓢ]	Preset speed 4			ID 119
Minimum value:	0.00 Hz	Maximum value:	MaxFreq Hz	Default value: 20.00 Hz
Description:	Preset speed is selected with digital inputs using a binary input.			

Table 57. Inputs (Cont.).

P2.3.5^②	Preset speed 5			ID 120
Minimum value:	0.00 Hz	Maximum value:	MaxFreq Hz	Default value: 25.00 Hz
Description:	Preset speed is selected with digital inputs using a binary input.			
P2.3.6^②	Preset speed 6			ID 121
Minimum value:	0.00 Hz	Maximum value:	MaxFreq Hz	Default value: 30.00 Hz
Description:	Preset speed is selected with digital inputs using a binary input.			
P2.3.7^②	Preset speed 7			ID 122
Minimum value:	0.00 Hz	Maximum value:	MaxFreq Hz	Default value: 35.00 Hz
Description:	Preset speed is selected with digital inputs using a binary input.			
P2.3.8^②	Jog reference			ID 117
Minimum value:	MinFreq Hz	Maximum value:	MaxFreq Hz	Default value: 0.00 Hz
Description:	Defines the jogging speed set point - this speed is selected with the digital input programmed for jogging speed. When enabled, the drive starts and ramps to this speed, input removed drive stops.			

P2.4 - AI settings.

P2.4.1	AI mode			ID 222
Minimum value:	N.A.	Maximum value:	N.A.	Default value: 1
Options:	0 = 0 - 20 mA; or 1 = 0 - 10 V.			
Description:	<p>Defines the analog input mode to current or voltage the DIP switches on control board will need to be set to the same mode as this parameter.</p> <p>*DM1 PRO CN5 terminals 8 and 9 for current or voltage, also need to set DIP switches SW2 2 and 3 on control board, near the RJ45 port.</p> <p>DIP switches SW2 2 and 3 off for voltage.</p> <p>Current mode, if using the +10 V supply on CN5 terminals 13 of the DM1 / DM1 Pro, it will require DIP switches SW2 2 and 3 on to complete the current loop. When doing a current loop with an external supply, the DIP switches SW2 2 off and 3 on.</p>			

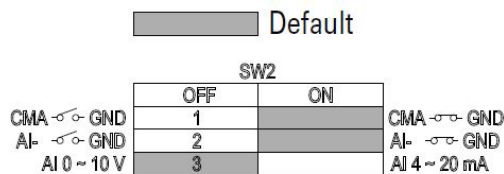
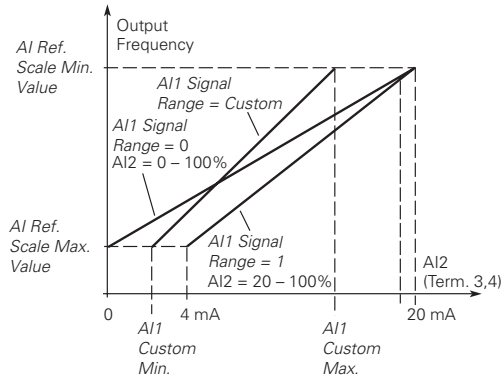
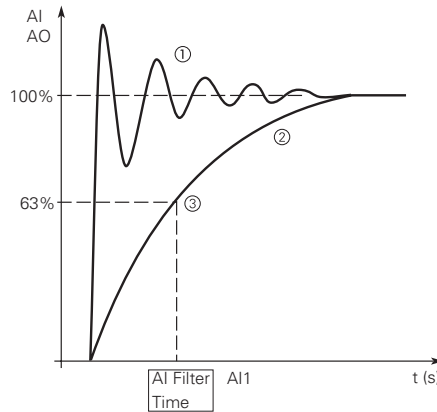

Table 57. Inputs (Cont.).

P2.4.2^②	AI signal range			ID 175
Minimum value:	N.A.	Maximum value:	N.A.	Default value: 0
Options:	0 = 0-100%/0-20 mA/0-10 V. 1 = 20-100%/4-20 mA/2-10 V. 2 = Customized.			
Description:	With this parameter, you can select the analog input 1 signal range. For selection "Customized," see "AI Custom Min" and "AI Custom Max", this enables a customized signal range.			



P2.4.3^②	AI custom minimum			ID 176
Minimum value:	0.00%	Maximum value:	Ai1CustomMax %	Default value: 0.00%
Descriptions:	Defines the minimum percentage for the input range to be associated with AI reference minimum scale.			
P2.4.4^②	AI custom maximim			ID 177
Minimum value:	Ai1CustomMin %	Maximum value:	100.00%	Default value: 100.00%
Descriptions:	Defines the minimum percentage for the input range to be associated with AI reference maximum scale.			
P2.4.5^②	AI filter time			ID 174
Minimum value:	0.00 s	Maximum value:	10.00 s	Default value: 0.10 s
Descriptions:	Defines the filter time applied to the analog input signal, zero equals no filtering.			



Notes: ① Analog signal with faults (unfiltered).
 ② Filtered analog signal.
 ③ Filter time constant at 63% of the set value.

Table 57. Inputs (Cont.).

P2.4.6^②	AI signal invert			ID 181
Minimum value:		Maximum value:		Default value: 0
Options:	0 = Not invert; or 1 = Invert.			
Descriptions:	Defines the filter time applied to the analog input signal, zero equals no filtering.			

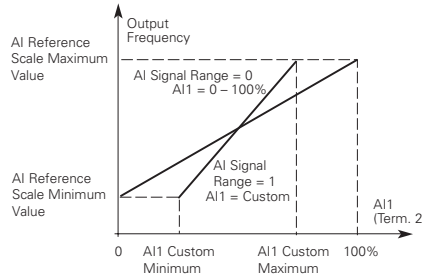

AI1 Signal Inversion

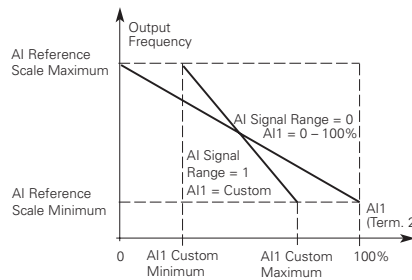

**Maximum AI1 signal = minimum set speed.
Minimum AI1 signal = maximum set speed.**

P2.4.7^②	AI joystick hysteresis			ID 178
Minimum value:	0.00%	Maximum value:	20.00%	Default value: 0.00%
Descriptions:	Defines the joystick hysteresis - when the analog input is within this range, the drive will interpret this as a zero speed reference.			

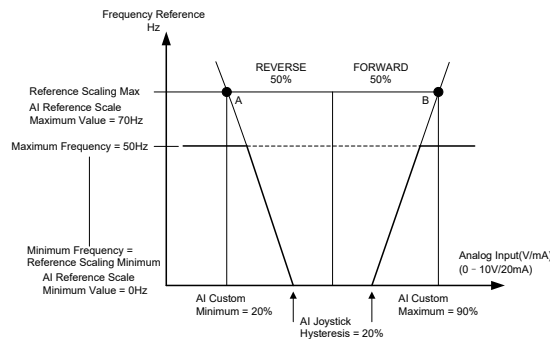
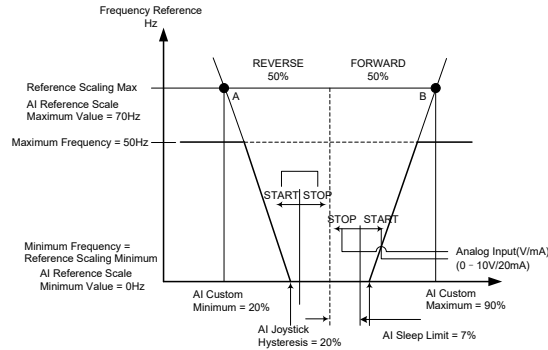

Table 57. Inputs (Cont.).

P2.4.8^②	AI sleep limit			ID 179
Minimum value:	0.00%	Maximum value:	100.00%	Default value: 0.00%

Descriptions: Defines the sleep level of the analog input - if the analog input signal is below this level for a time greater than the analog sleep delay, the drive will transition to a sleep state and restart when the analog input increases above this level.



P2.4.9^②	AI sleep delay			ID 180
Minimum value:	0.00 s	Maximum value:	320.00 s	Default value: 0.00 s
Descriptions:	Defines the delay for the analog input sleep level.			
P2.4.10^②	AI joystick offset			ID 133
Minimum value:	-50.00%	Maximum value:	50.00%	Default value: 0.00%
Descriptions:	Joysticks zero point by default is the middle of AI range. Joystick offset defines how much the zero point is moved in the forward or reverse from this analog input center point.			

P2.5 - Drive reference pot.

P2.5.1^②	Pot custom minimum			ID 1814
Minimum value:	0.00%	Maximum value:	100.00%	Default value: 20.00%
Description:	Defines the minimum percentage for the input range to be associated with AI reference minimum scale.			
P2.5.2^②	Pot custom maximim			ID 1815
Minimum value:	0.00%	Maximum value:	100.00%	Default value: 100.00%
Description:	Defines the maximum percentage for the input range to be associated with AI reference maximum scale.			
P2.5.3^②	Pot filter time			ID 1816
Minimum value:	0.00 s	Maximum value:	10.00 s	Default value: 1.00 s
Description:	Defines the filter time applied to the analog input signal - zero equals no filtering.			

① Parameter value can only be changed after the drive has stopped.

② Parameter value will be set to be default when changing macros.

Table 58. Outputs.

P3.1 - Digital output.					
P3.1.1²	RO1 function				ID 152
Minimum value:	N.A.	Maximum value:	N.A.	Default value:	2
Options:	0 = Not used - no action; 1 = Ready - drive is ready for operation; 2 = Run - drive is running; 3 = Fault - drive is faulted; 4 = Fault invert - drive is not faulted; 5 = Warning - drive has a warning message; 6 = Reverse - drive is outputting reverse phase rotation; 7 = At speed - the output frequency has reached the set reference; 8 = Zero frequency - drive output is at zero frequency; 9 = Frequency limit supervision - supervision for frequency limit 1 is activated; 10 = PI supervision - supervision for PI controller is activated; 11 = Torque limit supervision - supervision for torque limit; 12 = Reference limit supervision - supervision for reference limit; 13 = Power limit supervision - supervision for power limit; 14 = Temperature limit supervision - supervision for drive temperature limit; 15 = Analog input supervision - supervision for analog input limit; 16 = Motor current supervision - supervision for motor current limit; 17 = Over heat fault - drive over heat fault has occurred; 18 = Over current regular - over current regulator is enabled; 19 = Over volt regular - over volt regulator is enabled; 20 = Under volt regular - under volt regulator is enabled; 21 = 4 mA fault - 4 mA fault has occurred; 22 = External fault - external fault has occurred; 23 = Motor thermal fault - motor thermal fault has occurred; 24 = STO fault output - safe torque Off input is activated; 25 = Control from IO - I/O is the selected start command location; 26 = Remote control - remote is the control place; 27 = Un-requested rotation direction - the active direction isn't the same as the reference direction; 28 = Fire mode - drive is in fire mode; 29 = Damper control - damper control output; 30 = Valve control - valve control output; 31 = Jog speed - drive is in jog mode; 32 = Fieldbus input 1 - controlled by fieldbus control word; 33 = Fieldbus input 2 - controlled by fieldbus control word; 34 = DC charge switch close - DC pre-charge relay is closed; 35 = Preheat active - preheat control mode is activated; 36 = Cold weather active - Cold weather mode is active; 37 = PI sleep - PI controller is in a sleep state; 38 = 2nd stage ramp frequency active - accel./decel. time 2 is active; 39 = Prime pump active - drive is running in prime pump mode; 40 = Master drive state - indicates it is the master drive in the multi-pump control mode; 41 = Slave drive state - indicates it is the slave drive in the multi-pump control mode; or 43 = Single drive control - indicates the motor contactor is open or close in multi-pump control mode.				
Description:	Defines the function associated with changing the state of relay output 1.				
P3.1.2²	RO1 on delay				ID 2112
Minimum value:	0.0 s	Maximum value:	320.0 s	Default value:	0.0 s
Description:	Delay time for RO1 relay to turn on after signal received.				
P3.1.3²	RO1 off delay				ID 2113
Minimum value:	0.0 s	Maximum value:	320.0 s	Default value:	0.0 s
Description:	Delay time for RO1 relay to turn off after signal removed.				

Chapter 7- Multi-purpose application

Table 58. Outputs (Cont.).

P3.1.4^②	RO2 function			ID 153
Minimum value:	N.A.	Maximum value:	N.A.	Default value: 3
Options:	0 = Not used - no action; 1 = Ready - drive is ready for operation; 2 = Run - drive is running; 3 = Fault - drive is faulted; 4 = Fault invert - drive is not faulted; 5 = Warning - drive has a warning message; 6 = Reverse - drive is outputting reverse phase rotation; 7 = At speed - the output frequency has reached the set reference; 8 = Zero frequency - drive output is at zero frequency; 9 = Frequency limit supervision - supervision for frequency limit 1 is activated; 10 = PI supervision - supervision for PI controller is activated; 11 = Torque limit supervision - supervision for torque limit; 12 = Reference limit supervision - supervision for reference limit; 13 = Power limit supervision - supervision for power limit; 14 = Temperature limit supervision - supervision for drive temperature limit; 15 = Analog input supervision - supervision for analog input limit; 16 = Motor current supervision - supervision for motor current limit; 17 = Over heat fault - drive over heat fault has occurred; 18 = Over current regular - over current regulator is enabled; 19 = Over volt regular - over volt regulator is enabled; 20 = Under volt regular - under volt regulator is enabled; 21 = 4 mA fault - 4 mA fault has occurred; 22 = External fault - external fault has occurred; 23 = Motor thermal fault - motor thermal fault has occurred; 24 = STO fault output - safe torque Off input is activated; 25 = Control from IO - I/O is the selected start command location; 26 = Remote control - remote is the control place; 27 = Un-requested rotation direction - the active direction isn't the same as the reference direction; 28 = Fire mode - drive is in fire mode; 29 = Damper control - damper control output; 30 = Valve control - valve control output; 31 = Jog speed - drive is in jog mode; 32 = Fieldbus input 1 - controlled by fieldbus control word; 33 = Fieldbus input 2 - controlled by fieldbus control word; 34 = DC charge switch close - DC pre-charge relay is closed; 35 = Preheat active - preheat control mode is activated; 36 = Cold weather active - Cold weather mode is active; 37 = PI sleep - PI controller is in a sleep state; 38 = 2nd stage ramp frequency active - accel./decel. time 2 is active; 39 = Prime pump active - drive is running in prime pump mode; 40 = Master drive state - indicates it is the master drive in the multi-pump control mode; 41 = Slave drive state - indicates it is the slave drive in the multi-pump control mode; or 43 = Single drive control - indicates the motor contactor is open or close in multi-pump control mode.			
Description:	Defines the function associated with changing the state of relay output 2.			
P3.1.5^②	RO2 on delay			ID 2114
Minimum value:	0.0 s	Maximum value:	320.0 s	Default value: 0.0 s
Description:	Delay time for RO2 relay to turn on after signal received.			
P3.1.6^②	RO2 off delay			ID 2115
Minimum value:	0.0 s	Maximum value:	320.0 s	Default value: 0.0 s
Description:	Delay time for RO2 relay to turn off after signal removed.			
P3.1.7^②	RO2 reverse			ID 2118
Minimum value:	N.A.	Maximum value:	N.A.	Default value: 0
Options:	0 = No; or 1 = Yes.			
Description:	Inverts RO2 to be normally closed on the Form A relay.			

Table 58. Outputs (Cont.).

P3.1.8 ²	Virtual RO1 function	ID 2463
Minimum value:	N.A.	Maximum value: N.A.
		Default value: 2
Options:	0 = Not used - no action; 1 = Ready - drive is ready for operation; 2 = Run - drive is running; 3 = Fault - drive is faulted; 4 = Fault invert - drive is not faulted; 5 = Warning - drive has a warning message; 6 = Reverse - the drive is outputting reverse phase rotation; 7 = At speed - the output frequency has reached the set reference; 8 = Zero frequency - drive output is at zero frequency; 9 = Frequency limit supervision - supervision for frequency limit 1 is activated; 10 = PI supervision - supervision for PI controller is activated; 11 = Torque limit supervision - supervision for torque limit; 12 = Reference limit supervision - supervision for reference limit; 13 = Power limit supervision - supervision for power limit; 14 = Temperature limit supervision - supervision for drive temperature limit; 15 = Analog input supervision - supervision for analog input limit; 16 = Motor current supervision - supervision for motor current limit; 17 = Over heat fault - drive over heat fault has occurred; 18 = Over current regular - over current regulator is enabled; 19 = Over volt regular - over volt regulator is enabled; 20 = Under volt regular - under volt regulator is enabled; 21 = 4 mA fault - 4 mA fault has occurred; 22 = External fault - external fault has occurred; 23 = Motor thermal fault - motor thermal fault has occurred; 24 = STO fault output - safe torque off input is activated; 25 = Control from IO - I/O is the selected start command location; 26 = Remote control - remote is the control place; 27 = Unrequested rotation direction - the active direction is not the same as the reference direction; 28 = Fire mode - drive is in fire mode; 29 = Damper control - damper control output; 30 = Valve control - valve control output; 31 = Jog speed - drive is in jog mode; 32 = Fieldbus input 1 - controlled by FB control word; 33 = Fieldbus input 2 - controlled by FB control word; 34 = DC charge switch close - DC pre-charge relay is closed; 35 = Preheat active - preheat control mode is activated; 36 = Cold weather active - cold weather mode is active; 37 = PI sleep - PI controller is in a sleep state; 38 = 2nd stage ramp frequency active - accel./decel. time 2 is active; 39 = Prime pump active - drive is running in prime pump mode; 40 = Master drive state - indicates it is the master drive in the multi-pump control mode; 41 = Slave drive state - indicates it is the slave drive in the multi-pump control mode; or 43 = Single drive control - indicates the motor contactor is open or close in multi-pump control mode.	
Description:	Defines the function associated with changing the state of virtual RO.	

Chapter 7- Multi-purpose application

Table 58. Outputs (Cont.).

P3.1.9^②	Virtual RO2 function			ID 2464
Minimum value:	N.A.	Maximum value:	N.A.	Default value: 2
Options:	0 = Not used - no action; 1 = Ready - drive is ready for operation; 2 = Run - drive is running; 3 = Fault - drive is faulted; 4 = Fault invert - drive is not faulted; 5 = Warning - drive has a warning message; 6 = Reverse - the drive is outputting reverse phase rotation; 7 = At speed - the output frequency has reached the set reference; 8 = Zero frequency - drive output is at zero frequency; 9 = Frequency limit supervision - supervision for frequency limit 1 is activated; 10 = PI supervision - supervision for PI controller is activated; 11 = Torque limit supervision - supervision for torque limit; 12 = Reference limit supervision - supervision for reference limit; 13 = Power limit supervision - supervision for power limit; 14 = Temperature limit supervision - supervision for drive temperature limit; 15 = Analog input supervision - supervision for analog input limit; 16 = Motor current supervision - supervision for motor current limit; 17 = Over heat fault - drive over heat fault has occurred; 18 = Over current regular - over current regulator is enabled; 19 = Over volt regular - over volt regulator is enabled; 20 = Under volt regular - under volt regulator is enabled; 21 = 4 mA fault - 4 mA fault has occurred; 22 = External fault - external fault has occurred; 23 = Motor thermal fault - motor thermal fault has occurred; 24 = STO fault output - safe torque off input is activated; 25 = Control from IO - I/O is the selected start command location; 26 = Remote control - remote is the control place; 27 = Unrequested rotation direction - the active direction is not the same as the reference direction; 28 = Fire mode - drive is in fire mode; 29 = Damper control - damper control output; 30 = Valve control - valve control output; 31 = Jog speed - drive is in jog mode; 32 = Fieldbus input 1 - controlled by FB control word; 33 = Fieldbus input 2 - controlled by FB control word; 34 = DC charge switch close - DC pre-charge relay is closed; 35 = Preheat active - preheat control mode is activated; 36 = Cold weather active - cold weather mode is active; 37 = PI sleep - PI controller is in a sleep state; 38 = 2nd stage ramp frequency active - accel./decel. time 2 is active; 39 = Prime pump active - drive is running in prime pump mode; 40 = Master drive state - indicates it is the master drive in the multi-pump control mode; 41 = Slave drive state - indicates it is the slave drive in the multi-pump control mode; or 43 = Single drive control - indicates the motor contactor is open or close in multi-pump control mode.			
Description:	Defines the function associated with changing the state of virtual RO.			
P3.2 - Supervisions.				
P3.2.1^②	Frequency limit supervision			ID 154
Minimum value:	N.A.	Maximum value:	N.A.	Default value: 0
Options:	0 = No limit; 1 = Low limit supervision; or 2 = High limit Supervision.			
Description:	Selects how the drives frequency limit supervision controller functions.			
P3.2.2^②	Frequency limit display			ID 1821
Minimum value:	N.A.	Maximum value:	N.A.	Default value: 0
Options:	0 = Enable DO; 1 = Warning (W/O S)/enable DO; 2 = Warning (W S)/enable DO; or 3 = Fault/enable DO.			
Description:	Supervision display selection.			

Table 58. Outputs (Cont.).

P3.2.3^②	Frequency limit supervision value			ID 155
Minimum value:	0.00 Hz	Maximum value:	MaxFreq Hz	Default value: 0.00 Hz
Description:	Selects the frequency value supervised by the frequency limit supervision function.			
P3.2.4^②	Frequency limit supervision hysteresis			ID 2200
Minimum value:	0.10 Hz	Maximum value:	1.00 Hz	Default value: 0.10 Hz
Description:	This value selects the bandwidth between when the output frequency supervision enables and disables.			
P3.2.5^②	Torque limit supervision			ID 159
Minimum value:	N.A.	Maximum value:	N.A.	Default value: 0
Options:	0 = No limit; 1 = Low limit supervision; or 2 = High limit supervision.			
Description:	Supervision display selection.			
P3.2.6^②	Torque limit display			ID 1822
Minimum value:	N.A.	Maximum value:	N.A.	Default value: 0
Options:	0 = Enable DO; 1 = Warning (W/O S)/enable DO; 2 = Warning (W S)/enable DO; or 3 = Fault/enable DO.			
Description:	Supervision display selection.			
P3.2.7^②	Torque limit supervision value			ID 160
Minimum value:	-1,000.00%	Maximum value:	1,000.00%	Default value: 100.00%
Description:	Selects the torque value supervised by the torque limit supervision function.			
P3.2.8^②	Torque limit supervision hysteresis			ID 2202
Minimum value:	1.00%	Maximum value:	5.00%	Default value: 1.00%
Description:	This value selects the bandwidth between when the torque supervision enables and disables.			
P3.2.9^②	Reference limit supervision			ID 161
Minimum value:	N.A.	Maximum value:	N.A.	Default value: 0
Options:	0 = No limit; 1 = Low limit supervision; or 2 = High limit supervision.			
Description:	This value selects the bandwidth between when the torque supervision enables and disables.			
P3.2.10^②	Reference limit display			ID 1823
Minimum value:	N.A.	Maximum value:	N.A.	Default value: 0
Options:	0 = Enable DO; 1 = Warning (W/O S)/enable DO; 2 = Warning (W S)/enable DO; or 3 = Fault/enable DO.			
Description:	Supervision display selection.			

Table 58. Outputs (Cont.).

P3.2.11^②	Reference limit supervision value			ID 162
Minimum value:	0.00 Hz	Maximum value:	MaxFreq Hz	Default value: 0.00 Hz
Description:	Selects the reference frequency value supervised by the reference frequency limit supervision function.			
P3.2.12^②	Reference limit supervision hysteresis			ID 12203
Minimum value:	0.10 Hz	Maximum value:	1.00 Hz	Default value: 0.10 Hz
Description:	This value selects the bandwidth between when the reference limit supervision enables and disables.			
P3.2.13^②	Temperature limit supervision			ID 165
Minimum value:	N.A.	Maximum value:	N.A.	Default value: 0
Options:	0 = No limit; 1 = Low limit supervision; or 2 = High limit supervision.			
Description:	Selects how the drives temperature limit supervision controller functions.			
P3.2.14^②	Temperature limit display			ID 1842
Minimum value:	N.A.	Maximum value:	N.A.	Default value: 0
Options:	0 = Enable DO; 1 = Warning (W/O S)/enable DO; 2 = Warning (W S)/enable DO; or 3 = Fault/enable DO.			
Description:	Supervision display selection.			
P3.2.15^②	Temperature limit supervision value			ID 166
Minimum value:	-10.0°C	Maximum value:	75.0°C	Default value: 40.0°C
Description:	Selects the drive temperature value supervised by the drive temperature limit supervision function.			
P3.2.16^②	Temperature limit supervision hysteresis			ID 2204
Minimum value:	1.0°C	Maximum value:	10.0°C	Default value: 1.0°C
Description:	This value selects the bandwidth between when the temperature limit supervision enables and disables.			
P3.2.17^②	Power limit supervision			ID 167
Minimum value:	N.A.	Maximum value:	N.A.	Default value: 0
Options:	0 = No limit; 1 = Low limit supervision; or 2 = High limit supervision.			
Description:	Selects how the drives power limit supervision controller function.			
P3.2.18^②	Power limit display			ID 1825
Minimum value:	N.A.	Maximum value:	N.A.	Default value: 0
Options:	0 = Enable DO; 1 = Warning (W/O S)/enable DO; 2 = Warning (W S)/enable DO; or 3 = Fault/enable DO.			
Description:	Supervision display selection.			
P3.2.19^②	Power limit supervision value			ID 168
Minimum value:	-200.0%	Maximum value:	200.0%	Default value: 0.0%
Description:	Selects the output power value supervised by the power limit supervision function.			
P3.2.20^②	Power limit supervision hysteresis			ID 2205
Minimum value:	0.1%	Maximum value:	10.0%	Default value: 0.1%
Description:	This value selects the bandwidth between when the power limit supervision enables and disables.			

Table 58. Outputs (Cont.).

P3.2.21^②	AI supervision select			ID 170
Minimum value:	N.A.	Maximum value:	N.A.	Default value: 0
Options:	0 = Analog reference from AI; or 1 = Analog reference from keypad potentiometer.			
Description:	Selects analog signal to use for the analog input supervision.			
P3.2.22^②	AI limit supervision			ID 171
Minimum value:	N.A.	Maximum value:	N.A.	Default value: 0
Options:	0 = No limit; 1 = Low limit supervision; or 2 = High limit supervision.			
Description:	Selects analog signal to use for the analog input supervision.			
P3.2.23^②	AI limit display			ID 1826
Minimum value:	N.A.	Maximum value:	N.A.	Default value: 0
Options:	0 = Enable DO; 1 = Warning (W/O S)/enable DO; 2 = Warning (W S)/enable DO; or 3 = Fault/enable DO.			
Description:	Supervision display selection.			
P3.2.24^②	AI limit supervision value			ID 172
Minimum value:	1.00%	Maximum value:	10.00%	Default value: 0.00%
Description:	Selects the analog reference value supervised by the analog reference limit supervision function.			
P3.2.25^②	AI supervision hysteresis			ID 2198
Minimum value:	1.00%	Maximum value:	10.00%	Default value: 1.00%
Description:	This value selects the bandwidth between when the AI supervision enables and disables.			
P3.2.26^②	Motor current supervision			ID 2189
Minimum value:	N.A.	Maximum value:	N.A.	Default value: 0
Options:	0 = No limit; 1 = Low limit supervision; or 2 = High limit supervision.			
Description:	Selects how the motor current limit supervision controller functions.			
P3.2.27^②	Motor current limit display			ID 1827
Minimum value:	N.A.	Maximum value:	N.A.	Default value: 0
Options:	0 = Enable DO; 1 = Warning (W/O S)/enable DO; 2 = Warning (W S)/enable DO; or 3 = Fault/enable DO.			
Description:	Supervision display selection.			
P3.2.28^②	Motor current supervision value			ID 2190
Minimum value:	0.00 A	Maximum value:	DriveNomCurrCT*2 A	Default value: DriveNomCurrCT A
Description:	Selects the motor current value supervised by the motor current limit supervision function.			
P3.2.29^②	Motor current supervision hysteresis			ID 2196
Minimum value:	0.10 A	Maximum value:	1.00 A	Default value: 0.10 A
Description:	This value selects the bandwidth between when the motor current supervision enables and disables.			

Table 58. Outputs (Cont.).

P3.2.30^②	PI supervision enable			ID 1346
Minimum value:	N.A.	Maximum value:	N.A.	Default value: 0
Options:	0 = Disabled; or 1 = Enabled.			
Description:	Upper and lower limits around the reference are set. When the actual value goes above or below the upper limit and lower limit, the delay timer will increment. When the actual value is within the allowed area, the delay counter decrements. After the delay time expires, the relay output for PI supervision will be activated. This function is used for process value out of range faults.			
P3.2.31^②	PI supervision display			ID 1828
Minimum value:	N.A.	Maximum value:	N.A.	Default value: 0
Options:	0 = Enable DO; 1 = Warning (W/O S)/enable DO; 2 = Warning (W S)/enable DO; or 3 = Fault/enable DO.			
Description:	Supervision display selection.			
P3.2.32^②	PI supervision upper limit			ID 1347
Minimum value:	PI Process Unit Min varies	Maximum value:	PI Process Unit Max varies	Default value: 0.00 varies
Description:	Upper limit for PI feedback value used with the PI supervision controller.			
P3.2.33^②	PI supervision lower limit			ID 1349
Minimum value:	PI Process Unit Min varies	Maximum value:	PI Process Unit Max varies	Default value: 0.00 varies
Description:	Lower limit for PI feedback value used with the PI supervision controller.			
P3.2.34^②	PI supervision delay			ID 1351
Minimum value:	0 s	Maximum value:	3,000 s	Default value: 0 s
Description:	Defines the delay time that the PI feedback value must be out of range before activating the PI supervision output.			
P3.3 - Analog output.				
P3.3.1^②	AO mode			ID 227
Minimum value:	N.A.	Maximum value:	N.A.	Default value: 0
Options:	0 = 0 - 20 mA; or 1 = 0 - 10 V.			
Description:	Defines the analog output mode to current or voltage.			

Table 58. Outputs (Cont.).

P3.3.2^②	AO function			ID 146
Minimum value:	N.A.	Maximum value:	N.A.	Default value: 1
Options:	1 = Output frequency (0 - mMax frequency); 2 = Frequency reference (0 - max frequency); 3 = Motor speed RPM (0 - nameplate RPM); 4 = Motor current (0 - nameplate current); 5 = Motor torque (0 - calculated nominal); 6 = Motor power (0 - calculated nominal); 7 = Motor voltage (0 - nameplate voltage); 8 = DC bus voltage (0 - 1000 Vdc); 9 = PI setpoint (process unit minimum - process unit maximum); 10 = PI error value (process unit minimum - process unit maximum); 11 = PI output (process unit minimum- process unit maximum); 12 = Analog input (0% - 100%); 13 = Drive reference potentiometer (0% - 100%); 14 = Fieldbus process data input 1 (0% - 100%); 15 = Fieldbus process data input 2 (0% - 100%); 16 = Fieldbus process data input 3 (0% - 100%); 17 = Fieldbus process data input 4 (0% - 100%); 18 = Fieldbus process data input 5 (0% - 100%); 19 = Fieldbus process data input 6 (0% - 100%); 20 = Fieldbus process data input 7 (0% - 100%); 21 = Fieldbus process data input 8 (0% - 100%); 22 = User defined output (user defined minimum - user defined maximum); 23 = Motor torque (0% - 200%); or 24 = Motor power absolute value (0% - 100%).			
Description:	Select the function desired to the terminal AO1.			
P3.3.3^②	AO filter time			ID 147
Minimum value:	0.00 s	Maximum value:	10.00 s	Default value: 1.00 s
Description:	Defines the filter time applied to the analog output signal. Zero equals no filtering.			
				Notes ① Analog signal with faults (unfiltered). ② Filtered analog signal. ③ Filter time constant at 63% of the set value.
P3.3.4^②	AO custom minimum			ID 1863
Minimum value:	N.A.%	Maximum value:	N.A.%	Default value: 0.00%
Description:	Input axis start point x1, define AO function selected signal minimum value (percent) that user wants. Default value is 0. Negative value shall be allowed for x1. From (x1, y1) and (x2, y2) will get gain and offset. Then expected AO will calculate from gain and offset.			
P3.3.5^②	AO custom maximum			ID 1865
Minimum value:	N.A.%	Maximum value:	N.A.%	Default value: 100.00%
Description:	Input axis end piont x2, define AO function selected signal maximum value (percent) that user wants. Default value is 100%. Negative value shall be allowed for x2. From (x1,y1) and (x2,y2) will get gain and offset. Then expected AO will calculate from gain and offset.			

Chapter 7- Multi-purpose application

Table 58. Outputs (Cont.).

P3.3.6^②	AO value minimum			ID 1867
Minimum value:	0.00 varies	Maximum value:	100.00 varies	Default value: 0.00 varies
Description:	Start point output axis y1, define AO value selected by AO mode, y1 is related to x1. Default value is 0 mA. From (x1,y1) and (x2,y2) will get gain and offset. Then expected AO will calculate from gain and offset.			
P3.3.7^②	AO value maximum			ID 1868
Minimum value:	0.00 varies	Maximum value:	100.00 varies	Default value: 20.00 varies
Description:	End point output axis y2, define AO value selected by AO mode, y2 is related to x2. Default value is 20 mA. From (x1,y1) and (x2,y2) will get gain and offset. Then expected AO will calculate from gain and offset.			

^② Parameter value will be set to be default when changing macros.

Table 59. Drive control.

P4.1 - Basic settings.				
P4.1.1^②	Keypad reference			ID 141
Minimum value:	MinFreq Hz	Maximum value:	MaxFreq HZ	Default value: 0.00 Hz
Description:	Keypad reference value.			
P4.1.2^②	Keypad/drive reference pot direction			ID 141
Minimum value:	N.A.	Maximum value:	N.A.	Default value: 0
Options[”]	0 = Forward; or 1 = Reverse.			
Description:	Forward - the rotation of the motor is forward or clockwise direction, when the keypad is the active control place. Reverse - the rotation of the motor is reversed or counter clockwise direction, when the keypad is the active control place.			
P4.1.3^②	Keypad stop			ID 114
Minimum value:	N.A.	Maximum value:	N.A.	Default value: 1
Options:	0 = Enabled - keypad operation - In this mode, the keypad stop will only operate when the control source is set to keypad. 1 = Always enabled - In this mode, the stop button will always stop the drive regardless of control mode.			
Description:	Enabled or always enabled keypad operation.			
P4.1.4^①	Reverse enabled			ID 1679
Minimum value:	N.A.	Maximum value:	N.A.	Default value: 1
Options:	0 = Disabled; or 1 = Enabled.			
Description:	Enables or disables the reverse motor direction.			
P4.1.5	Change phase sequence motor			ID 2515
Minimum value:	N.A.	Maximum value:	N.A.	Default value: 0
Options:	0 = Change disable; or 1 = Change enable.			
Description:	This parameter allows for swapping the motor phase output from u, v, w to u, w, v.			
P4.1.6^②	Power up local remote select			ID 1685
Minimum value:	N.A.	Maximum value:	N.A.	Default value: 0
Options:	0 = Hold last; 1 = Local control; or 2 = Remote control.			
Description:	Selects what control place the drive will start at after power is applied. The default setting will hold the last state that the drive was in when powered down, selecting Local or Remote will cause the drive to start in that mode regardless of last state.			

Table 59. Drive control (Cont.).

P4.1.8^②	Start mode			ID 252
Minimum value:	N.A.	Maximum value:	N.A.	Default value: 0
Options:	0 = Ramp - The drive starts from 0 Hz and ramps to the frequency reference value. 1 = Flying start from stop frequency - The drive will catch a spinning motor. This setting searches for the current frequency using the last operating frequency as a starting point. 2 = Flying start from maximum frequency - The drive will catch a spinning motor. This setting searches for the current frequency using the maximum operating frequency as a starting point.			
Description:	Selects the start mode operation.			
P4.1.9^②	Stop mode			ID 253
Minimum value:	N.A.	Maximum value:	N.A.	Default value: 1
Options:	0 = Coasting - After a stop command, the motor coasts to a stop uncontrolled by the drive. 1 = Ramp - After the stop command, the speed of the motor is decelerated according to the set deceleration parameters.			
Description:	Selects the stop mode operation.			
P4.1.10^②	Ramp 1 shape			ID 247
Minimum value:	0.0 s	Maximum value:	10.0 s	Default value: 0.0 s
Description:	The start and end of the acceleration and deceleration ramps can be smoothed with these parameters. Setting a value of 0.00 seconds gives a linear ramp shape that causes acceleration and deceleration to react immediately to the changes in the reference signal. Setting a value from 0.10 to 10.00 seconds for this parameter produces an S-shaped acceleration/deceleration at the start and stop of the slope.			

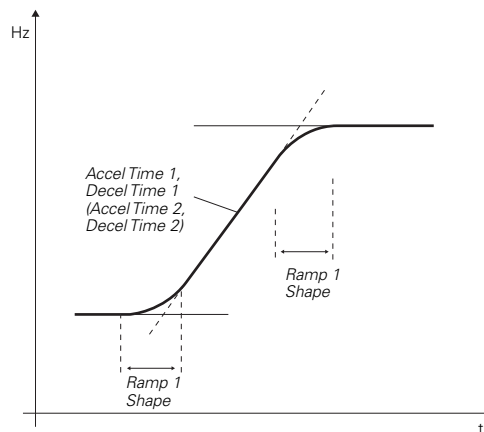
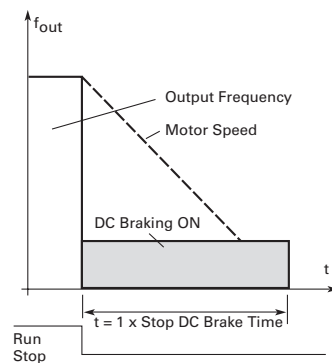

Table 59. Drive control (Cont.).

P4.1.11^②	Ramp 2 shape			ID 248
Minimum value:	0.0 s	Maximum value:	10.0 s	Default value: 0.0 s
Description:	<p>The start and end of the acceleration and deceleration ramps can be smoothed with these parameters. Setting a value of 0.00 gives a linear ramp shape that causes acceleration and deceleration to react immediately to the changes in the reference signal.</p> <p>Setting a value from 0.10 to 10.00 seconds for this parameter produces an S-shaped acceleration/deceleration at the start and stop of the slope.</p>			
P4.1.12^②	Accel. time 2			ID 249
Minimum value:	0.1 s	Maximum value:	3000.0 s	Default value: 10.0 s
Description:	<p>These values correspond to the time required for the output frequency to accelerate from the zero frequency to the set maximum frequency.</p> <p>These parameters provide the possibility to set two different acceleration/deceleration time sets for one application. The active set can be selected with the programmable digital input.</p>			
P4.1.13^②	Decel. time 2			ID 250
Minimum value:	0.1 s	Maximum value:	3000.0 s	Default value: 10.0 s
Description:	<p>These values correspond to the time required for the output frequency to decelerate from the set maximum frequency to the zero frequency.</p> <p>These parameters provide the possibility to set two different acceleration/deceleration time sets for one application. The active set can be selected with the programmable digital input.</p>			
P4.1.14^{①②}	2nd Stage ramp frequency			ID 2444
Minimum value:	MinFreq Hz	Maximum value:	MaxFreq Hz	Default value: 30.00 Hz
Description:	<p>When 2nd stage ramp frequency is the frequency level at which the drive will enable the 2nd stage ramp frequency output function. This then can be used for other inputs or devices to signal a frequency level.</p>			
P4.1.15^{①②}	Fult reset start			ID 2483
Minimum value:	N.A.	Maximum value:	N.A.	Default value: 0
Options:	<p>0 = Start/stop after fault reset - the run command has to be cycled to restart after fault reset; or 1 = Restart after fault reset - the run command is still active after fault the drive will restart without re-sending command.</p>			
Description:	<p>Defines how the drive run command responds after a fault reset command.</p>			
P4.2 - Brake.				
P4.2.1^{①②}	Brake chopper enable			ID 829
Minimum value:	N.A.	Maximum value:	N.A.	Default value: 0
Options:	<p>0 = Disable - dynamic brake OFF; or 1 = Enable - dynamic brake ON.</p>			
Description:	<p>If an external resistor is connected to the drive setting, this parameter to enabled will allow excess DC bus voltage to be bled off through the attached resistor.</p>			

Table 59. Drive control (Cont.).

P4.2.2 ^{①②}	DC brake current			ID 254
Minimum value:	DriveNomCurrCT*15/100 A	Maximum value:	DriveNomCurrCT*15/10 A	Default value: DriveNomCurrCT*1/2 A
Description:	Defines the current level injected into the motor during DC-braking.			
P4.2.3 ^{①②}	Start DC brake time			ID 263
Minimum value:	0.00 s	Maximum value:	600.00 s	Default value: 0.00 s
Description:	This parameter defines the time the drive injects DC braking current before starting to ramp. This can be used to stop motors that are potentially spinning before a run command is given or before ramping to reference level. This is to stop motors that are potentially spinning before a run command is given.			
P4.2.4 ^{①②}	Stop DC brake frequency			ID 262
Minimum value:	0.10 Hz	Maximum value:	10.00 Hz	Default value: 1.50 Hz
Description:	During a ramp to stop, this parameter defines the output frequency to be below to begin DC braking.			
P4.2.5 ^{①②}	Stop DC brake time			ID 255
Minimum value:	0.00 s	Maximum value:	600.00 s	Default value: 0.00 s
Description:	Determines the length of DC braking while stopping. 0.00 = DC brake is not used; or >0.0 = The amount of time DC-braking will occur after falling below the stop DC brake frequency.			



DC braking time when stop mode = coasting.

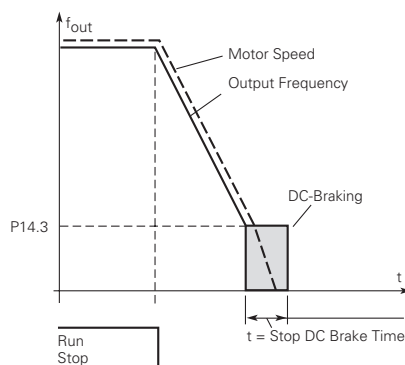

DC braking time when stop mode = ramp.

Table 59. Drive control (Cont.).

P4.2.6 ^{①②}	Flux brake			ID 266
Minimum value:	N.A.	Maximum value:	N.A.	Default value: 0
Options:	0 = Flux braking OFF; or 1 = Flux braking ON.			
Description:	While stopping, the output frequency is reduced and the flux in the motor is increased, which in turn increases the motor's capability to brake. Unlike DC braking, the motor speed remains controlled during braking. The flux braking can be set ON or OFF.			
	Note: Flux braking converts the energy into heat in the motor and should be used carefully to avoid motor damage.			
P4.2.7 ^{①②}	Flux brake current			ID 265
Minimum value:	MotorNomCurr*1/10	Maximum value:	CurrLimit A	Default value: MotorNomCurr*1/2 A
Description:	Defines the flux braking current value output when flux brake is enabled.			

P4.3 - Skip frequency.

P4.3.1 ^①	Skip range ramp factor			ID 264
Minimum value:	0.1	Maximum value:	10.0	Default value: 1.0
Description:	Defines the acceleration/deceleration time when the output frequency is between the selected prohibit frequency range limits. The ramping speed (selected acceleration/deceleration time 1 or 2) is multiplied with this factor: e.g., value 0.1 makes the acceleration time 10 times shorter than outside the prohibit frequency range limits.			

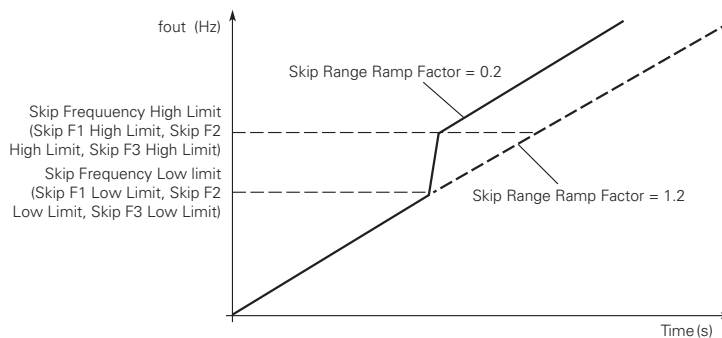

Ramp speed scaling between skip frequencies.

P4.3.2 ^②	Skip F1 low limit			ID 256
Minimum value:	0.00 Hz	Maximum value:	SkipRange1HighLimit Hz	Default value: 0.00 Hz
Description:	Defines the acceleration/deceleration time when the output frequency is between the selected prohibit frequency range limits. The ramping speed (selected acceleration/deceleration time 1 or 2) is multiplied with this factor: e.g., value 0.1 makes the acceleration time 10 times shorter than outside the prohibit frequency range limits.			
P4.3.3 ^②	Skip F1 high limit			ID 257
Minimum value:	SkipRange1LowLimit Hz	Maximum value:	400.00 Hz	Default value: 0.00 Hz
Description:	Defines the acceleration/deceleration time when the output frequency is between the selected prohibit frequency range limits. The ramping speed (selected acceleration/deceleration time 1 or 2) is multiplied with this factor: e.g., value 0.1 makes the acceleration time 10 times shorter than outside the prohibit frequency range limits.			
P4.3.4 ^②	Skip F2 low limit			ID 258
Minimum value:	0.00 HZ	Maximum value:	SkipRange2HighLimit Hz	Default value: 0.00 Hz
Description:	Defines the acceleration/deceleration time when the output frequency is between the selected prohibit frequency range limits. The ramping speed (selected acceleration/deceleration time 1 or 2) is multiplied with this factor: e.g., value 0.1 makes the acceleration time 10 times shorter than outside the prohibit frequency range limits.			
P4.3.5 ^②	Skip F2 high limit			ID 259
Minimum value:	SkipRange2LowLimit HZ	Maximum value:	400.00 Hz	Default value: 0.00 Hz
Description:	Defines the acceleration/deceleration time when the output frequency is between the selected prohibit frequency range limits. The ramping speed (selected acceleration/deceleration time 1 or 2) is multiplied with this factor: e.g., value 0.1 makes the acceleration time 10 times shorter than outside the prohibit frequency range limits.			

Table 59. Drive control (Cont.).

P4.3.6^①	Skip F3 low limit			ID 260
Minimum value:	0.00 HZ	Maximum value:	SkipRange3HighLimit Hz	Default value: 0.00 Hz
Description:	Defines the acceleration/deceleration time when the output frequency is between the selected prohibit frequency range limits. The ramping speed (selected acceleration/deceleration time 1 or 2) is multiplied with this factor: e.g., value 0.1 makes the acceleration time 10 times shorter than outside the prohibit frequency range limits.			
P4.3.7^①	Skip F3 high limit			ID 261
Minimum value:	SkipRange3LowLimit HZ	Maximum value:	400.00 Hz	Default value: 0.00 Hz
Description:	Defines the acceleration/deceleration time when the output frequency is between the selected prohibit frequency range limits. The ramping speed (selected acceleration/deceleration time 1 or 2) is multiplied with this factor: e.g., value 0.1 makes the acceleration time 10 times shorter than outside the prohibit frequency range limits.			
P4.4 - Energy savings calculations.				
P4.4.1^①	Currency			ID 2122
Minimum value:	N.A.	Maximum value:	N.A.	Default value: 0
Options:	0 = \$; 1 = £; 2 = €; 3 = ¥; 4 = R\$; 5 = R\$; 6 = Fr; or 7 = kr.			
Description:	Sets the local currency used for energy savings estimation.			
P4.4.2^①	Energy cost			ID 2123
Minimum value:	Varies	Maximum value:	Varies	Default value: 0.00 varies
Description:	Sets the local energy cost per kW. Used for energy savings estimation.			
P4.4.3^①	Data type			ID 2124
Minimum value:	N.A.	Maximum value:	N.A.	Default value: 0
Options:	0 = Cumulative; 1 = Daily average; 2 = Weekly average; 3 = Monthly average; or 4 = Yearly average.			
Description:	Selects the format to view energy savings. The drive takes four recordings in an hour and then calculates the average based off this parameter. The savings estimation is based on comparing the drives energy usage compared to a across the line starter.			
P4.4.4	Energy savings reset			ID 2125
Minimum value:	N.A.	Maximum value:	N.A.	Default value: N.A.
Options:	0 = Not reset; or 1 = Reset.			
Description:	Resets the energy savings value.			

^① Parameter value can only be changed after the drive has stopped.

^② Parameter value will be set to be default when changing macros.

Table 60. Motor control.

P5.1 - Basic settings.				
P5.1.1^{①②}	Motor control mode			ID 287
Minimum value:	N.A.	Maximum value:	N.A.	Default value: 0
Options:	0 = Frequency control - Output frequency is controlled directly by the frequency reference. 1 = Speed control - Output frequency is controlled by giving a frequency reference to it with slip compensation. 2 = Open loop vector control - Similar to the standard speed control mode, higher performance slip calculation requires running a motor identification. 3 = PM control 1 - PM motor control mode 1, used for SPM (surface mounted permanent magnet) and it also can be used for IPM. 4 = PM control 2 - PM motor control mode 2, used for IPM (internally mounted permanent magnet) and it can not be used for SPM.			
Description:	Selects the motor control mode.			
P5.1.2^①	Current limit			ID 107
Minimum value:	DriveNomCurrCT*1/10 A	Maximum value:	DriveNomCurrCT*2 A	Default value: DriveNomCurrCT*3/2 A
Description:	This parameter determines the maximum output current allowed from the drive. The parameter value range differs from size to size. Once the motor current hits this level, it goes into the current limiter controller and tries to limit the output current.			
P5.1.3^{①②}	V/Hz optimization			ID 109
Minimum value:	N.A.	Maximum value:	N.A.	Default value: 0
Options:	0 = Disable torque boost function. 1 = Enable torque boost function.			
Description:	Automatic torque boost - the voltage to the motor increases automatically, which assists the motor to produce sufficient torque to start and run at low frequencies with high loads.			
P5.1.4^{①②}	V/Hz ratio			ID 108
Minimum value:	N.A.	Maximum value:	N.A.	Default value: 0
Options:	0 = Linear - the voltage of the motor changes linearly with the frequency in the constant flux area from 0 Hz to the field weakening point where the nominal voltage is supplied. A linear V/Hz ratio should be used in constant torque applications. 1 = Squared - the voltage of the motor changes following a squared curve with the frequency in the area from 0 Hz to the field weakening point where the nominal voltage is supplied. The motor runs under magnetized below the field weakening point and produces less torque and electromechanical noise. A squared V/Hz ratio can be used in applications where the torque demand of the load is proportional to the square of the speed. 2 = Programmable V/Hz curve - the V/Hz curve can be programmed with three different points. These points are the 0 frequency voltage, midpoint and weakening point. A programmable V/Hz curve can be used if the other settings do not satisfy the needs of the application. 3 = Linear with flux optimization - the drive starts to search for the minimum motor current in order to save energy. This mode is called Eaton's Active Energy Control which will reduce the voltage and current but still maintain the desired speed.			
Description:	Selects the V/Hz ratio. 0 = Linear; 1 = Squared; 2 = Programmable; or 3 = Linear + flux optimization.			
 <p style="text-align: center;">0 = Linear and 1 = Squared.</p>				
P5.1.5^{①②}	Field weakening point			ID 289
Minimum value:	8.00 Hz	Maximum value:	400.00 Hz	Default value: FieldWeakPointMFG Hz
Description:	The field weakening point is the frequency at which the output voltage reaches the set maximum value. This value is usually determined by the motor nameplate value.			

Table 60. Motor control (Cont.).

P5.1.6^{①②}	Voltage at FWP			ID 290
Minimum value:	10.00%	Maximum value:	200.00%	Default value: 00.00%
Description:	Defines the voltage at the field weakening point, when the output frequency exceeds the field weakening point, the voltage will remain constant.			
P5.1.7^{①②}	VV/Hz mid frequency			ID 291
Minimum value:	0.00 H	Maximum value:	FieldWeakPoint Hz	Default value: VHzCurveMidFreqMFG Hz
Description:	If the programmable V/Hz curve has been selected, this parameter defines the midpoint frequency of the curve. This value can be set anywhere between 0 and the field weakening point. To either have a different V/Hz ramp or if set to the FWP, it will provide the field weakening point voltage all the way up the curve.			
P5.1.8^{①②}	VV/Hz mid voltage			ID 292
Minimum value:	0.00%	Maximum value:	100.00%	Default value: 100.00%
Description:	If the programmable V/Hz curve has been selected, this parameter defines the mid-point voltage of the curve. This value can be set anywhere between zero frequency volt and the field weakening point voltage.			
P5.1.9^{①②}	Zero frequency voltage			ID 293
Minimum value:	0.00%	Maximum value:	40.00%	Default value: 0.00%
Description:	If the programmable V/Hz curve has been selected, this parameter defines the zero frequency voltage of the curve.			
P5.1.10^②	Switching frequency			ID 288
Minimum value:	MinSwitchFreq kHz	Maximum value:	MaxSwitchFreq kHz	Default value: DefaultSwitchFreqCT kHz
Description:	Sets the switching frequency for the PWM output waveform.			
P5.1.11^②	Sine filter enabled			ID 1665
Minimum value:	N.A.	Maximum value:	N.A.	Default value: 0
Options:	0 = Disabled; or 1 = Enabled.			
Description:	This parameter enables the drive to have a fixed switching frequency which is required by some sine filters. The drive no longer automatically adjusts the switching frequency based on the unit temperature.			
P5.1.12^{①②}	Over voltage controller			ID 294
Minimum value:	N.A.	Maximum value:	N.A.	Default value: 3
Options:	0 = Disable over voltage controller; 1 = The maximum controller output frequency is the (ramp frequency + 8 Hz); 2 = The maximum controller output frequency is the maximum frequency; or 3 = The maximum controller output frequency is the (maximum frequency + 8 Hz).			
Description:	The over voltage control is used to limit the DC link voltage below the preset limit value. If over voltage control is enabled, the drive will control the DC link voltage below the preset limit value by increasing the output frequency to allow the motor to use the energy.			
P5.1.13^①	Over voltage controller reference			ID 1874
Minimum value:	DCLinkUnderVolt-ResumeExcursion V	Maximum value:	DCLinkOverVoltBrake-ChopperStartLimit V	Default value: DCLinkRegenerating-EnergyControlExcursion V
Description:	The over voltage reference defines the preset limit value used in the overvoltage controller.			
P5.1.14^②	Load drooping			ID 298
Minimum value:	0.00%	Maximum value:	100.00%	Default value: 0.00%
Description:	The drooping function enables speed drop as a function of load. This parameter sets that amount corresponding to the nominal torque of the motor.			
P5.1.15^②	Droop control filter time constant			ID 1630
Minimum value:	0 ms	Maximum value:	3,000 ms	Default value: 0 ms
Description:	Filter time when using droop control.			

Chapter 7- Multi-purpose application

Table 60. Motor control (Cont.).

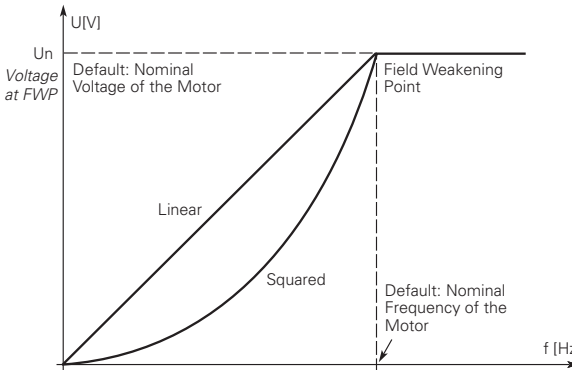
P5.1.16^{②②}	Identification			ID 299
Minimum value:	N.A.	Maximum value:	N.A.	Default value: 0
Options:	0 = Not action. 1 = Identification only stator resistor - does not spin the motor. This can be done with load attached. 2 = Identification with run - motor stator resistor is completed then the motor is run. This must be completed with unloaded motor. 3 = Identification no run - motor is supplied with current and voltage but at zero frequency. 4 = Identification only inertia - identification for the system inertia only.			
Description:	This parameter enables the drive to make an motor identification cycle of the motor once complete the drive will adjust tuning parameters to improve starting torque and open loop vector control performance. Once set and a run command is given, the operation will be active then set back to 0 when completed. When a run command is issued, the message on the keypad will indicate "Auto tuning" is being performed. If there is an issue with the motor identification, a fault message will be displayed.			
P5.1.17^①	Stator resistor			ID 771
Minimum value:	0.001 ohm	Maximum value:	65.535 ohm	Default value: Base on motor.
Description:	Motor stator resistor real value - this value is the stator winding resistance of the windings in the motor. The value is measured when performing identification.			
P5.1.18^①	Rotor resistor			ID 772
Minimum value:	0.001 ohm	Maximum value:	65.535 ohm	Default value: Base on motor.
Description:	Motor rotor resistor real value - this value is the rotor resistance of the motor. The value is measured when performing identification.			
P5.1.19^①	Leak inductance			ID 773
Minimum value:	0.01 mh	Maximum value:	655.35 mh	Default value: Base on motor.
Description:	Motor leakage inductance real value - this value is the amount of magnetic inductance that does not link to a winding in the motor. The value is measured when performing identification.			
P5.1.20^①	Mutual inductance			ID 774
Minimum value:	0.10 mh	Maximum value:	6553.50 mh	Default value: Base on motor.
Description:	Motor mutual inductance real value - this value is the amount of inductance between two sets of windings in the motor. The value is measured when performing identification.			
P5.1.21^①	Excitation current			ID 775
Minimum value:	0.01 A	Maximum value:	655.35 A	Default value: Base on motor.
Description:	Motor no-load current real value - this value is the amount of electrical current required to generate a rotating magnetic field in the motor. The value is measured when performing identification (P5.1.16).			
P5.1.22^①	Motor inertia			ID 1881
Minimum value:	0.000 kgm ²	Maximum value:	65.535 kgm ²	Default value: Base on motor.
Description:	System rotation inertia - real value for speed loop parameter tuning. The value is measured when performing identification.			
P5.1.23^①	PM back electromotive force (BEMF) voltage			ID 1882
Minimum value:	0.0 V	Maximum value:	6553.5 V	Default value: 0.1 V
Description:	Back electromotive force (BEMF) voltage. The value is measured when performing identification.			
P5.1.24^①	PM d-axis stator inductance			ID 1884
Minimum value:	0.00 mh	Maximum value:	655.35 mh	Default value: 0.01 mh
Description:	Voltage across the d-axis stator inductance of the PM motor at the rated motor current and the rated motor frequency displayed in line-to-line rms value. The value is measured when performing identification.			
P5.1.25^①	PM q-axis stator inductance			ID 1883
Minimum value:	0.00 mh	Maximum value:	655.35 mh	Default value: 0.01 mh
Description:	Voltage across the q-axis stator inductance of the PM motor at the rated motor current and the rated motor frequency displayed in line-to-line rms value. The value is measured when performing identification.			
P5.1.26	Slip compensation coefficient			ID 1664
Minimum value:	0%	Maximum value:	500%	Default value: 100%
Description:	The linear coefficient of the slip compensation frequency, which is valid only in the speed control mode.			

Table 60. Motor control (Cont.).

P5.1.27	<i>VF stable Kd</i>			ID 1888
Minimum value:	0%	Maximum value:	1,000%	Default value: 100%
Description:	The compensation coefficient of the d-axis, which is used to suppress oscillation.			
P5.1.28	<i>VF stable Kq</i>			ID 1889
Minimum value:	0%	Maximum value:	1,000%	Default value: 100%
Description:	The compensation coefficient of the q-axis, which is used to suppress oscillation.			
P5.1.29^{①②}	<i>Over-modulation enable</i>			ID 2835
Minimum value:	N.A.	Maximum value:	N.A.	Default value: 0
Options:	0 = Disabled; or 1 = Enabled.			
Description:	The linear coefficient of the slip compensation frequency, which is valid only in the speed control mode.			
P5.2 - Sensorless Vector Control parameters.				
P5.2.1^②	<i>Speed error filter time constant</i>			ID 1591
Minimum value:	0 ms	Maximum value:	3,000 ms	Default value: 20 ms
Description:	Filter time constant for speed reference and actual speed error.			
P5.2.2	<i>Speed control Kp1</i>			ID 1830
Minimum value:	0.0%	Maximum value:	6,000.0%	Default value: 100.0%
Description:	Sets P-gain of "Vector" control mode when in frequency region 1 for faster speed response.			
P5.2.3	<i>Speed control Ti1</i>			ID 1831
Minimum value:	1 ms	Maximum value:	3,000 ms	Default value: 100 ms
Description:	Sets time constant of "Vector" control mode when in frequency region 1 for faster speed response.			
P5.2.4^②	<i>Speed control FS1</i>			ID 1832
Minimum value:	0.00 Hz	Maximum value:	SPEED_CONTROL_FS2 Hz	Default value: 5.00 Hz
Description:	Sets the "Vector" control mode frequency.			
P5.2.5^②	<i>Speed control FS2</i>			ID 1833
Minimum value:	SPEED_CONTROL_ FS1 Hz	Maximum value:	MaxFreq Hz	Default value: 10.00 Hz
Description:	Sets the "Vector" control mode frequency.			
P5.2.6^②	<i>Speed control Kp2</i>			ID 1834
Minimum value:	0.0%	Maximum value:	6,000.0%	Default value: 50.0%
Description:	Sets P-gain of "Vector" control mode when in frequency region two for faster speed response.			
P5.2.7^②	<i>Speed control Ti2</i>			ID 1835
Minimum value:	1 ms	Maximum value:	3,000 ms	Default value: 100 ms
Description:	Sets time constant of "Vector" control mode when in frequency region two for faster speed response.			
P5.2.8^②	<i>Motoring torque limit FWD</i>			ID 1836
Minimum value:	0.0%	Maximum value:	300.0%	Default value: 300.0%
Description:	Motoring torque limit in the forward direction.			
P5.2.9^②	<i>Generator torque limit FWD</i>			ID 1837
Minimum value:	0.0%	Maximum value:	300.0%	Default value: 300.0%
Description:	Generation torque limit in the forward direction.			

Chapter 7- Multi-purpose application

Table 60. Motor control (Cont.).

P5.2.10^②	Motoring torque limit REV			ID 1838
Minimum value:	0.0%	Maximum value:	300.0%	Default value: 300.0%
Description:	Motoring torque limit in the reverse direction.			
P5.2.11^②	Generator torque limit REV			ID 1839
Minimum value:	0.0%	Maximum value:	300.0%	Default value: 300.0%
Description:	Generation torque limit in the reverse direction.			
P5.2.12^②	Motoring power limit			ID 1607
Minimum value:	0.0%	Maximum value:	300.0%	Default value: 300.0%
Description:	Motor power limit setting.			
P5.2.13^②	Generator power limit			ID 1608
Minimum value:	0.0%	Maximum value:	300.0%	Default value: 300.0%
Description:	Generator power limit setting.			
P5.2.14^{①②}	Flux reference			ID 1620
Minimum value:	0.0%	Maximum value:	500.0%	Default value: 100.0%
Description:	This parameter defines the amount of flux that is output to the motor, which is valid only in open loop vector control.			
P5.2.15^①	PM initial selection			ID 1890
Minimum value:	N.S.	Maximum value:	N.A.	Default value: 1
Options:	0 = Align; 1 = Six pulse; or 2 = HFI.			
Description:	PM initial angle detect method.			
P5.2.16^①	PM initial time			ID 1891
Minimum value:	0.0 s	Maximum value:	60.0 s	Default value: 0.7 s
Description:	PM initial angle detect time.			
P5.2.17^①	PM excited current			ID 1892
Minimum value:	0%	Maximum value:	200%	Default value: 20%
Description:	PM excited current during the low speed.			
P5.2.18^①	PM excited current off frequency			ID 1893
Minimum value:	10.00%	Maximum value:	MotorNomFreq %	Default value: 20.00%
Description:	PM excited current cut off frequency.			
P5.2.19	Observer Kp			ID 2901
Minimum value:	1%	Maximum value:	3,000%	Default value: 100%
Description:	Linear gain of the PM/IM observer.			

^① Parameter value can only be changed after the drive has stopped.

^② Parameter value will be set to be default when changing macros.

Table 61. Protections.

P6.1 - Motor.				
P6.1.1^{①②}	Output phase fault			ID 308
Minimum value:	N.A.	Maximum value:	N.A.	Default value: 2
Options:	0 = No response; 1 = Warning; 2 = Fault - stop mode after fault according to parameter stop mode; or 3 = Fault - stop mode after fault always by coasting.			

Table 61. Protections (Cont.).

Description:	Output phase supervision of the motor ensures that the motor phases have equal currents. If phases are 5% difference from one another, the frequency converter will respond corresponding to this setting.			
P6.1.2^{①②}	Ground fault			ID 309
Minimum value:	N.A.	Maximum value:	N.A.	Default value: 2
Options:	0 = No response; 1 = Warning; 2 = Fault - stop mode after fault according to parameter stop mode; or 3 = Fault - stop mode after fault always by coasting.			
Description:	Earth (ground) fault protection ensures that the sum of the motor phase currents is zero. There is a current level setting parameter ground fault limit that allows for setting the allowable ground current level based off the total drive current. The overcurrent protection is always working and protects the frequency converter from earth faults with high currents. Frequency converter will correspond the setting (see Options above).			
P6.1.3^{①②}	Ground fault limit			ID 2158
Minimum value:	0%	Maximum value:	30%	Default value: 15%
Description:	Sets the level of the ground fault protection. This protection is based off the amount of leakage current that is seen to ground on the output of the drive.			
P6.1.4^{①②}	Motor thermal protection			ID 310
Minimum value:	N.A.	Maximum value:	N.A.	Default value: 2
Options:	0 = No response; 1 = Warning; 2 = Fault - stop mode after fault according to parameter stop mode; or 3 = Fault - stop mode after fault always by coasting.			
Description:	If a fault condition is selected, the drive will stop and activate the fault stage based off the % of calculated motor temperature. The calculated motor temp is based off the install power on values of the drive and monitoring values as the drive is running. Deactivating this protection, i.e., setting parameter to 0, will reset the thermal stage of the motor to 0%.			
P6.1.5^②	Motor thermal FO current			ID 311
Minimum value:	0.00%	Maximum value:	150.00%	Default value: 100.00%
Description:	The current can be set between 0 - 150.0% x InMotor. This parameter sets the value for thermal current at zero frequency. The default value is set assuming that there is no external fan cooling the motor. If an external fan is used, this parameter can be set to 90% (or even higher).			
Note:	The value is set as a percentage of the motor nameplate data, P1.6 (nominal current of the motor), not the drive's nominal output current. The motor's nominal current is the current that the motor can withstand in direct on-line use without being overheated. If you change the parameter nominal current of motor, this parameter is automatically restored to the default value. Setting this parameter does not affect the maximum output current of the drive.			

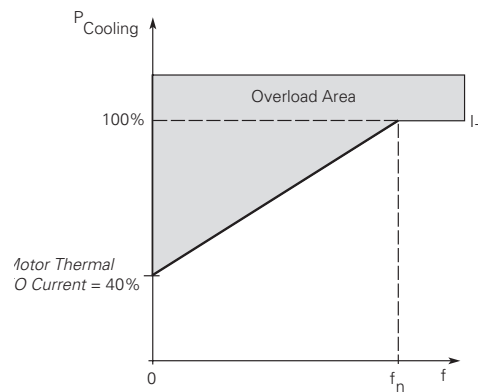
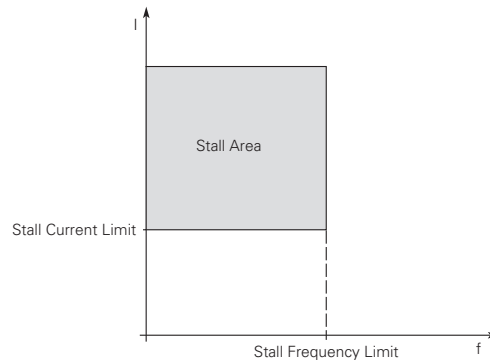

Table 61. Protections (Cont.).

P6.1.6^②	Stall protection			ID 313
Minimum value:	N.A.	Maximum value:	N.A.	Default value: 0
Options:	0 = No action; 1 = Warning; 2 = Fault; or 3 = Fault, coast.			
Description:	Stall protection is a user defined of overcurrent protection. It protects the motor from short time overload situations like a stalled shaft. This is customer selectable based off of current level, frequency level, and time.			

P6.1.7^②	Stall current limit			ID 314
Minimum value:	0.10 A	Maximum value:	2 * MotorNomCurr A	Default value: 1.3 * MotoNomCurr A
Description:	The current can be set to 0.1–InMotor*2. For a stall stage to occur, the current must have exceeded this limit. The software does not allow entering a greater value than InMotor*2. If P1.6, nominal motor current is changed, this parameter is automatically restored to the default value (IL).			



P6.1.8^②	Stall time limit			ID 315
Minimum value:	1.0 s	Maximum value:	120.0 s	Default value: 15.0 s
Description:	This time can be set between 1.0 and 120.0s. This is the maximum time allowed for a stall stage. The stall time is counted by an internal up/down counter based off the current being above the limit setting. If the stall time counter value goes above this limit the protection will cause a trip (see P6.1.6).			

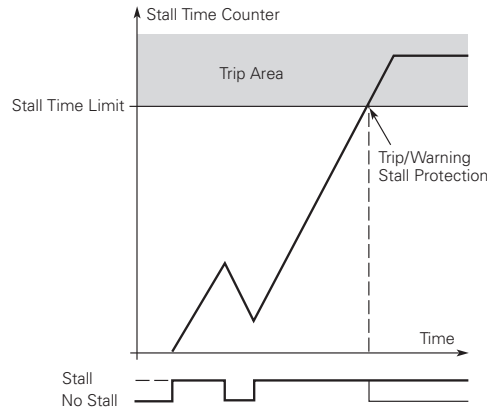

P6.1.9^②	Stall frequency limit			ID 316
Minimum value:	1.00 Hz	Maximum value:	MaxFreq Hz	Default value: 25.00 Hz
Description:	The frequency can be set between 1–fmax (P1.2). For a stall state to occur, the output frequency must have remained below this limit, above the current limit for the stall time to occur.			

Table 61. Protections (Cont.).

P6.1.10^{①②}	Underload protection			ID 317
Minimum value:	N.A.	Maximum value:	N.A.	Default value: 0
Options:	0 = No response; 1 = Warning; 2 = Fault - stop mode after fault according to parameter stop mode; or 3 = Fault - stop mode after fault always by coasting.			
Description:	If fault is set as the function, the drive will stop and activate the fault stage based on the parameter conditions and the monitoring status of the motor. If the motor torque drops below the F _{nom} and F ₀ torque levels for the time limit the protection is enabled. Deactivating the protection by setting the parameter to 0 will reset the underload time counter to zero.			
P6.1.11^{①②}	Underload F_{nom} torque			ID 318
Minimum value:	10.0%	Maximum value:	150.0%	Default value: 50.0%
Description:	The torque limit can be set between 10.0 - 150.0 % x T _n Motor. This parameter gives the value for the minimum torque allowed when the output frequency is at or above the field weakening point. If you change P1.6, nominal motor current, this parameter is automatically restored to the default value.			
P6.1.12^②	Underload F₀ torque			ID 319
Minimum value:	5.0%	Maximum value:	150.0%	Default value: 10.0%
Description:	The torque limit can be set between 5.00 - 150.00% x T _n Motor. This parameter gives value for the minimum torque allowed at zero frequency. If you change the value of P1.6, nominal motor current, this parameter is automatically restored to the default value.			

Table 61. Protections (Cont.).

P6.1.13²	Underload time limit			ID 320
Minimum value:	2.00 s	Maximum value:	600.00 s	Default value: 20.00 s
Description:	This time can be set between 2.00 and 600.00 seconds. This is the time allowed for an fault state to exist. An internal up/down counter counts the accumulated underload time. If the underload counter value goes above this limit, the protection will cause a trip according to protection parameter. If the drive is stopped, the counter is reset to zero.			
P6.1.14²	Preheat mode			ID 2159
Minimum value:	N.A.	Maximum value:	N.A.	Default value: 0
Options:	0 = Disable; or 1 = Enable			
Description:	This parameter enables/disables the preheat function where this is used where the temperature being read from the drive will turn on the output to allow current to flow to the motor, this is typically used when the motor is not running.			
P6.1.15²	Preheat control source			ID 2160
Minimum value:	N.A.	Maximum value:	N.A.	Default value: 1
Options:	0 = DI function; or 1 = Drive temperature.			
Description:	Selects the source of where the temperature is coming from, either digital input or the drive heat sink temperature, which potentially could be at a different temperature.			
P6.1.16²	Preheat enter temperature			ID 2161
Minimum value:	-10.0°C	Maximum value:	20.0°C	Default value: 10.0°C
Description:	Temperature when the preheat is enabled - drive goes into a run state to all the preheat voltage to flow through the motor an create some current.			
P6.1.17²	Preheat quit temperature			ID 2162
Minimum value:	-10.0°C	Maximum value:	39.9°C	Default value: 20.0°C
Description:	Temperature when the preheat is disabled - drive goes into a stop state if the temperature is above this rating.			

Table 61. Protections (Cont.).

P6.2 - Drive.				
P6.2.1 ^②	Line start lockout			ID 750
Minimum value:	N.A.	Maximum value:	N.A.	Default value: 2
Options:	0 = Respond to I/O run command when power is applied. If in another control place and switched to I/O, control does not respond. (Run command has to be cycled.) 1 = Do not respond to I/O run command when power is applied. If in another control place and switched to I/O, control does not respond. (Run command has to be cycled.) 2 = Respond to I/O commands when power is applied. If in another control place and switched to I/O control, the drive will respond to a maintained run command. 3 = Do not respond to I/O commands when power is applied. If in another control place and switched to I/O control, the drive will respond to a maintained run command.			
Description:	Determines the response of frequency converter going to a run state cycle with I/O run command is still active as the control place.			
P6.2.2 ^{②③}	Input phase fault			ID 332
Minimum value:	N.A.	Maximum value:	N.A.	Default value: 2
Options:	0 = No response; 1 = Warning; 2 = Fault, stop mode after fault according to parameter stop mode; 3 = Fault, stop mode after fault always by coasting; or 4 = Single phase power limit.			
Description:	The input phase supervision ensures that the input phases of the frequency converter have approximately equal current draw.			
P6.2.3 ^{②③}	4 mA input fault			ID 306
Minimum value:	N.A.	Maximum value:	N.A.	Default value: 0
Options:	0 = No response; 1 = Warning; 2 = Warning - the frequency from 10 seconds back is set as reference; 3 = Warning - the preset frequency P6.2.4 is set as reference; 4 = Fault - stop mode after fault according to parameter stop mode; or 5 = Fault - stop mode after fault always by coasting.			
Description:	A warning or a fault action and message is generated if the 4 - 20 mA reference signal is used and the signal falls below 4 mA for 5 seconds, or below 0.5 mA for 0.5 seconds. The information can also be programmed into relay outputs R01 and R02.			
P6.2.4 ^{②③}	4 mA fault frequency			ID 331
Minimum value:	0.00 Hz	Maximum value:	MaxFreq Hz	Default value: 0.00 Hz
Description:	When 4 mA fault happens, the output frequency of drive goes to this preset speed when P6.2.3 = 3.			
P6.2.5 ^{②③}	External fault			ID 307
Minimum value:	N.A.	Maximum value:	N.A.	Default value: 2
Options:	0 = No action; 1 = Warning; 2 = Fault, stop mode after fault according to parameter stop mode; or 3 = Fault, stop mode after fault always by coasting.			
Description:	A warning or a fault action and message is generated from the external fault signal in the programmable (digital inputs function select external fault). The status information can also be programmed into digital output relay outputs R01 and R02.			
P6.2.6 ^{②③}	Undervoltage fault response			ID 330
Minimum value:	N.A.	Maximum value:	N.A.	Default value: 2
Options:	0 = No response; 1 = Warning; 2 = Fault, stop mode after fault according to parameter stop mode; or 3 = Fault, stop mode after fault always by coasting.			
Description:	Frequency converter monitors DC Bus voltage if it drops below set level (via trouble shooting guide for more information on fault level), the drive will respond corresponding to this setting.			

Chapter 7- Multi-purpose application

Table 61. Protections (Cont.).

P6.2.7^{①②}	Unit under temperature protection			ID 1564
Minimum value:	N.A.	Maximum value:	N.A.	Default value: 2
Options:	0 = No action; 1 = Warning; 2 = Fault; or 3 = Fault, coast.			
Description:	This protection sets the response to a low frequency converter temperature on the heat sink.			
P6.2.8^②	Cold weather mode			ID 2126
Minimum value:	N.A.	Maximum value:	N.A.	Default value: 0
Options:	0 = Disabled; or 1 = Enabled.			
Description:	With this parameter, you are able to enable the cold weather function of the causing the frequency converter's under temp limit to drop from -10°C to -30°C. This then enables a warm-up feature when the frequency converter is between -30°C and -20°C. The motor, when given a run command, will turn on for the cold weather time-out and output the cold weather voltage at 0.5 Hz to allow the motor to warm up. If it does not warm up above -20°C, after that the time frequency converter will fault on under temp fault. If the frequency converter does go above -20°C, output will begin to follow reference.			
P6.2.10^②	Cold weather time out			ID 2128
Minimum value:	0 min	Maximum value:	10 min	Default value: 3 min
Description:	With this parameter, you are able to select the time limit that the frequency converter will run in the warm-up period.			
P6.2.11^②	STO fault response			ID 2427
Minimum value:	N.A.	Maximum value:	N.A.	Default value: 2
Options:	0 = No Action - drive will stop, no indication shown, no reset required, have to cycle start command. 1 = Warning - drive indicate warning/if STO clears drive will run without reset. 2 = Fault - drive will indicate fault/require reset to start again.			
Description:	STO fault response defines the function of how the STO input will be seen on the keypad and how the drive functions to it.			
P6.2.12^①	PI feedback AI loss response			ID 2401
Minimum value:	N.A.	Maximum value:	N.A.	Default value: 0
Options:	0 = No action; 1 = Warning; 2 = Fault; or 3 = Warning: preset frequency (P6.2.13).			
Description:	This parameter defines the function of the PI feedback analog input loss response. If the AI feedback is lost based off the programed AI feedback.			
P6.2.13^{①②}	PI feedback AI loss pre-frequency			ID 2402
Minimum value:	0.00 Hz	Maximum value:	400.00 Hz	Default value: 0.00 Hz
Description:	This parameter defines the frequency the master would run to if a feedback is lost and P6.2.12 was set to option 3.			
P6.2.14^②	PI feedback AI loss pipe fill			ID 2403
Minimum value:	0.0 varies	Maximum value:	1000.0 varies	Default value: 0.0 varies
Description:	Detects loss of prime in the pump based off the measured level. If the value drops below this level for the time in P6.2.15 and below, the frequency in P6.2.13 "loss of prime" occurs.			
P6.2.15^②	PI feedback AI loss pre-frequency timeout			ID 2404
Minimum value:	0 s	Maximum value:	6,000 s	Default value: 0 s
Description:	PI feedback AI loss pre-frequency timeout - when P6.2.12 is set to 3 or 4, when the feedback signal is lost, the drive will run at the frequency in P6.2.13 for the time set here. After this time, the drive will fault out on "feedback loss". The time is disabled when set to 0 seconds.			
P6.2.16^{①②}	Overvoltage controller response			ID 1840
Minimum value:	N.A.	Maximum value:	N.A.	Default value: 0
Options:	0 = No action; 1 = Warning (W/O S); or 2 = Warning (W S).			
Description:	Display options for overvoltage controller warning.			

Table 61. Protections (Cont.).

P6.2.17 ^{①②}	Overcurrent controller response			ID 1841
Minimum value:	N.A.	Maximum value:	N.A.	Default value: 0
Options:	0 = No action; 1 = Warning (W/O S); or 2 = Warning (W S).			
Description:	Display options for current limit controller warning.			
P6.2.18	Cold weather password			ID 2129
Minimum value:	N.A.	Maximum value:	N.A.	Default value: 0
Description:	This password allows access to override the under temperature fault protection. This parameter is seen by pressing the left and right soft keys on the keypad. Password should be set to 62385. This value gets reset on cycle of power.			
P6.2.19	Under-temperature fault override			ID 2130
Minimum value:	N.A.	Maximum value:	N.A.	Default value: 0
Options:	0 = No; or 1 = Yes.			
Description:	With the password set to the correct value, this parameter is enabled and will give the ability to override the under temp fault. This function gets reset when power is cycled.			
P6.3 - Communications.				
P6.3.1 ^{①②}	Fieldbus fault response			ID 334
Minimum value:	N.A.	Maximum value:	N.A.	Default value: 2
Options:	0 = No action; 1 = Warning; 2 = Fault; or 3 = Fault, coast.			
Description:	This sets the response mode for the fieldbus fault when a fieldbus mode is used and communication is lost between the PLC and communication port. Each protocol has another parameter to select in all control or only in fieldbus control to set fault or warning.			
P6.3.2 ^{①②}	OPTcard fault response			ID 335
Minimum value:	N.A.	Maximum value:	N.A.	Default value: 2
Options:	0 = No action; 1 = Warning; 2 = Fault; or 3 = Fault, coast.			
Description:	This sets the response mode for a board slot fault caused by a missing or failed option board not communicating to the central processor.			
P6.3.3 ^{①②}	IP address confliction response			ID 1678
Minimum value:	N.A.	Maximum value:	N.A.	Default value: 1
Options:	0 = No action; 1 = Warning; 2 = Fault - stop mode after fault according to parameter stop mode; or 3 = Fault - stop mode after fault always by coasting.			
Description:	Indicates there is a conflict in the IP address assigned to the drive, typically meaning there are multiple devices with the same IP address assigned. .			
P6.3.4 ^{①②}	Keypad communication fault response			ID 2157
Minimum value:	N.A.	Maximum value:	N.A.	Default value: 0
Options:	0 = No action; 1 = Warning; 2 = Fault; or 3 = Fault, coast.			
Description:	This parameter defines the function of the keypad communication response in the case the keypad is removed.			

Table 61. Protections (Cont.).

P6.4 - Auto restart.				
P6.4.1^②	AR wait time			ID 321
Minimum value:	1.00 s	Maximum value:	300.00 s	Default value: 1.00 s
Description:	Defines the time before the frequency converter tries to automatically restart the motor after a specific fault condition has been clear.			
P6.4.2^②	AR trail time			ID 322
Minimum value:	1.00 s	Maximum value:	600.00 s	Default value: 30.00 s
Description:	Amount of time after fault set that the drive uses the restart attempts to reset the fault and restart the motor, after this time has run out without resetting the alarm drive will fault.			
	P6.4.4 to P6.4.11 determine the maximum number of automatic restarts during the trial time set by P6.4.2. The time count starts from the first auto restart. If the number of faults occurring during the trial time exceeds the values of P6.4.4 to P6.4.11, the fault state becomes active. Otherwise the fault is cleared after the trial time has elapsed and the next fault starts the trial time count again. If a single fault remains during the trial time, a fault state is true.			
	Auto Restart Fail (Try Number >2.)			
P6.4.3^②	AR start function			ID 323
Minimum value:	N.A.	Maximum value:	N.A.	Default value: 0
Options:	0 = Flying start from stop frequency; 1 = Start according to parameter stop mode; or 2 = Flying start from maximum frequency.			
Description:	The start function for automatic restart is selected with this parameter. The parameter defines the start mode upon an auto restart condition. Defines the time before the frequency converter tries to automatically restart the motor after a specific fault condition has been clear.			
P6.4.4^②	Undervoltage attempts			ID 324
Minimum value:	0	Maximum value:	10	Default value: 1
Description:	This parameter determines how many automatic restarts can be made during the trial time after an undervoltage trip.			
	0 = No automatic restart. >0 = Number of automatic restarts after undervoltage fault.			
	The fault is reset and the drive is started automatically after the DC-link voltage has returned to the normal level.			
P6.4.5^②	Overvoltage attempts			ID 325
Minimum value:	0	Maximum value:	10	Default value: 1
Description:	This parameter determines how many automatic restarts can be made during the trial time after an overvoltage trip.			
	0 = No automatic restart after overvoltage fault trip. >0 = Number of automatic restarts after overvoltage fault trip.			
	The fault is reset and the drive is started automatically after the DC-link voltage has returned to the normal level.			

Table 61. Protections (Cont.).

P6.4.6^②	Overcurrent attempts			ID 326
Minimum value:	0	Maximum value:	3	Default value: 1
Description:	This parameter determines how many automatic restarts can be made during the trial time. Note: An IGBT temperature fault, saturation fault, and overcurrent faults are included as part of this fault. 0 = No automatic restart after overcurrent fault trip. >0 = Number of automatic restarts after an overcurrent trip, saturation trip, or IGBT temperature fault.			
P6.4.7^②	4 mA fault attempts			ID 327
Minimum value:	0	Maximum value:	10	Default value: 1
Description:	This parameter determines how many automatic restarts can be made during the trial time. 0 = No automatic restart after reference fault trip. >0 = Number of automatic restarts after the analog current signal (4–20 mA) has returned to the normal level (>4 mA).			
P6.4.8^②	Motor temperature fault attempts			ID 329
Minimum value:	0	Maximum value:	10	Default value: 1
Description:	This parameter determines how many automatic restarts can be made during the trial time. 0 = No automatic restart after Motor temperature fault trip. >0 = Number of automatic restarts after the motor temperature has returned to its normal level.			
P6.4.9^②	External fault attempts			ID 328
Minimum value:	0	Maximum value:	10	Default value: 0
Description:	This parameter determines how many automatic restarts can be made during the trial time. 0 = No automatic restart after external fault trip. >0 = Number of automatic restarts after external fault trip.			
P6.4.10^②	Underload attempts			ID 336
Minimum value:	0	Maximum value:	10	Default value: 1
Description:	This parameter determines how many automatic restarts can be made during the trial time. 0 = No automatic restart after an underload fault trip. >0 = Number of automatic restarts after an underload fault trip.			
P6.4.11^②	PI feedback AI loss attempts			ID 2405
Minimum value:	0	Maximum value:	10	Default value: 1
Description:	This parameter sets the amount of tries it will try to auto restart the feedback AI loss fault.			

^① Parameter value can only be changed after the drive has stopped.

^② Parameter value will be set to be default when changing macros.

Table 62. PI Controller.

P7.1 - Basic settings.				
P7.1.1^②	PI control gain			ID 1294
Minimum value:	0.00%	Maximum value:	200.00%	Default value: 100.00%
Description:	Defines the gain of the PI Controller. It adjust the slope of the speed increase according to the initial of the load. If this value is set to 100%, a change of 10% in the error value causes the controller output to change 10%.			
P7.1.2^②	PI control itime			ID 1295
Minimum value:	0.00 s	Maximum value:	600.00 s	Default value: 1.00 s
Description:	Defines the integration time of the PI controller. Over the time, the integral time contributes to the deviation between the reference and the feedback signal. If this value is set to 1.00 sec., a change of 10% in the error value causes the controller output to change by 10.00%/s.			

Chapter 7- Multi-purpose application

Table 62. PI Controller (Cont.).

P7.1.3^{①②}	PI process unit			ID 1297
Minimum value:	N.A.	Maximum value:	N.A.	Default value: 0
Options:	0 = %; 1 = 1/min.; 2 = rpm; 3 = ppm; 4 = pps; 5 = l/s; 6 = l/min.; 7 = l/h; 8 = kg/s; 9 = kg/min.; 10 = kg/h; 11 = m ³ /s; 12 = m ³ /min.; 13 = m ³ /h; 14 = m/s; 15 = mbar; 16 = bar; 17 = Pa; 18 = kPa; 19 = mV/S; 20 = kW; 21 = Deg. C; 22 = GPM; 23 = gal/s; 24 = gal/min.; 25 = gal/h; 26 = lb/s; 27 = lb/min.; 28 = lb/h; 29 = CFM; 30 = ft ³ /s; 31 = ft ³ /min.; 32 = ft ³ /h; 33 = ft/s; 34 = in. wg; 35 = ft wg; 36 = PSI; 37 = lb/in.2; 38 = HP; 39 = Deg. F; 40 = PA; 41 = WC; 42 = HG; 43 = ft; or 44 = m.			
Description:	Defines the unit type for PI feedback unit.			
P7.1.4^②	PI process unit minimum			ID 1298
Minimum value:	-99999.99 varies	Maximum value:	PI Process Unit Max varies	Default value: 0.00 varies
Description:	Defines the minimum process unit value.			
P7.1.5^②	PI process unit maximum			ID 1300
Minimum value:	PI Process Unit Min	Maximum value:	99999.99 varies	Default value: 100.00 varies
Description:	Defines the maximum process unit value.			
P7.1.6^{①②}	PI error inversion			ID 1303
Minimum value:	N.A.	Maximum value:	N.A.	Default value: 0
Options:	0 = Normal - if feedback is less than set-point, PI controller output increases. 1 = Inverted - if feedback is less than set-point, PI controller output decreases.			
Description:	Defines the way the process value output reacts to the feedback signal.			

Table 62. PI Controller (Cont.).

P7.1.7^②	PI dead band			ID 1304
Minimum value:	-99999.99 varies	Maximum value:	99999.99 varies	Default value: 0 varies
Description:	PI dead band around setpoint in process units. This is the band where no actions occur to prevent oscillation or repeated activation/deactivation of controller. The PI output is locked if the feedback stays within the dead band area.			
P7.1.8^②	PI dead band delay			ID 1306
Minimum value:	0.00 s	Maximum value:	320.00 s	Default value: 0.00 s
Description:	If the PI process value goes out of the dead band area for the desired time delay, at that point the controller will re-initialize and try to level out again.			
P7.1.9^②	PI ramp time			ID 1311
Minimum value:	0.00 s	Maximum value:	300.00 s	Default value: 0.00 s
Description:	Defines the rising and falling ramp times for changes in the process value.			

① Parameter value can only be changed after the drive has stopped.

② Parameter value will be set to be default when changing macros.

Table 63. Setpoint.

P7.2.1 - Standard.				
P7.2.1.1^②	PI keypad setpoint 1			ID 1307
Minimum value:	PI Process Unit Min	Maximum value:	PI Process Unit Max	Default value: 0.00 varies
Description:	Keypad PI reference value setpoint 1.			
P7.2.1.2^②	PI keypad setpoint 2			ID 1309
Minimum value:	PI Process Unit Min	Maximum value:	PI Process Unit Max	Default value: 0.00 varies
Description:	Keypad PI reference value setpoint 2.			
P7.2.1.3^②	PI wake-up action			ID 2466
Minimum value:	N.A.	Maximum value:	N.A.	Default value: 0
Options:	0 = Wake-up when below wake-up level. 1 = Wake-up when above wake-up-level. 2 = Wake-up when below wake-up level % from PI setpoint. 3 = Wake-up when above wake-up level %from PI setpoint.			
Description:	This parameter defines the wake-up function action.			
P7.2.2 - Setpoint 1.				
P7.2.2.1^①	PI setpoint 1 source			ID 1312
Minimum value:	N.A.	Maximum value:	N.A.	Default value: 1
Options:	0 = Not used; 1 = PI keypad setpoint 1; 2 = PI keypad setpoint 2; 3 = AI; 4 = Drive reference pot; 5 = FB process data input 1; 6 = FB process data input 2; 7 = FB process data input 3; 8 = FB process data input 4; 9 = FB process data input 5; 10 = FB process data input 6; 11 = FB process data input 7; 12 = FB process data input 8; 13 = FB PI setpoint 1; or 14 = FB PI setpoint 2.			
Description:	Defines source of the setpoint value the drive uses. This can either be an internal preset value, keypad setpoint, analog signal, or fieldbus message.			

Chapter 7- Multi-purpose application

Table 63. Setpoint (Cont.).

P7.2.2.2^①	PI setpoint 1 sleep enable			ID 1315
Minimum value:	N.A.	Maximum value:	N.A.	Default value: 0
Options:	0 = Disabled; or 1 = Enabled.			
Description:	This function will disable the output when the frequency drops below the sleep frequency for the sleep delay time. The output re-engages when feedback rises above the wake-up level.			
P7.2.2.3^②	PI setpoint 1 sleep delay			ID 1317
Minimum value:	0 s	Maximum value:	3,000 s	Default value: 0 s
Description:	This parameter sets the delay time after the setpoint drops below the sleep level for this amount of time and then the drives output will shut off till the wake up level is met. It is to prevent large fluctuations when going into the sleep function to save motor run time.			
P7.2.2.4^②	PI setpoint 1 wake-up level			ID 1318
Minimum value:	-99999.99 varies	Maximum value:	99999.99 varies	Default value: 0.00 varies
Description:	Defines the level for the PI feedback value to go above top enable the PI output to be re enabled. This value is based of the % of feedback which can be scaled based off the PI unit min./max, values.			
P7.2.2.5^②	PI setpoint 1 boost			ID 1320
Minimum value:	-2.00 varies	Maximum value:	2.00 varies	Default value: 1.00 varies
Description:	The setpoint can be boosted via a multiplier value.			
P7.2.2.6^②	PI setpoint 1 sleep level			ID 2450
Minimum value:	MinFreq Hz	Maximum value:	MaxFreq Hz	Default value: 0.00 Hz
Description:	Defines the level of which the unit value is used to look at to go into the sleep mode. When the unit drops below this level for the sleep delay time, it will put the drive into the sleep mode.			
P7.2.2.7^②	SP1 sleep mode over cycle time			ID 1842
Minimum value:	0	Maximum value:	10	Default value: 0
Description:	Defines the count the drive come in and out of sleep mode. If multiple times done in this time frame, the drive would trip on "pump over cycle" fault. One cycle is defined when the drive transfers from normal mode to sleep mode. 0 value means do not do the sleep over cycle check and clear "pump over cycle" fault.			
P7.2.2.8^②	SP1 sleep mode maximum cycle time			ID 1843
Minimum value:	0 s	Maximum value:	3,600 s	Default value: 300 s
Description:	Defines the maximum time for sleep over cycle checking.			
P7.2.3 - Setpoint 2.				
P7.2.3.1^①	PI setpoint 2 source			ID 1321
Minimum value:	N.A.	Maximum value:	N.A.	Default value: 1
Options:	0 = Not used; 1 = PI keypad setpoint 1; 2 = PI keypad setpoint 2; 3 = AI; 4 = Drive reference pot; 5 = FB process data input 1; 6 = FB process data input 2; 7 = FB process data input 3; 8 = FB process data input 4; 9 = FB process data input 5; 10 = FB process data input 6; 11 = FB process data input 7; 12 = FB process data input 8; 13 = FB PI setpoint 1; or 14 = FB PI setpoint 2.			
Description:	Defines source of the setpoint value the drive uses. This can either be an internal preset value, keypad setpoint, analog signal, or fieldbus message.			

Table 63. Setpoint (Cont.).

P7.2.3.2^①	PI setpoint 2 sleep enable			ID 1324
Minimum value:	N.A.	Maximum value:	N.A.	Default value: 0
Options:	0 = Disabled; or 1 = Enabled.			
Description:	This function will disable the output when the frequency drops below the sleep frequency for the sleep delay time. The output re-engages when feedback rises above the wake-up level.			
P7.2.3.3^②	PI setpoint 2 sleep delay			ID 1326
Minimum value:	0 s	Maximum value:	3,000 s	Default value: 0 s
Description:	This parameter sets the delay time after the setpoint drops below the sleep level for this amount of time and then the drives output will shut off till the wake up level is met. It is to prevent large fluctuations when going into the sleep function to save motor run time.			
P7.2.3.4^②	PI setpoint 2 wake-up level			ID 1327
Minimum value:	-99999.99 varies	Maximum value:	99999.99 varies	Default value: 0.00 varies
Description:	Defines the level for the PI feedback value to go above top enable the PI output to be re enabled. This value is based of the % of feedback which can be scaled based off the PI unit min./max, values.			
P7.2.3.5^②	PI setpoint 2 boost			ID 1329
Minimum value:	-2.00 varies	Maximum value:	2.00 varies	Default value: 1.00 varies
Description:	The setpoint can be boosted via a multiplier value.			
P7.2.3.6^②	PI setpoint 2 sleep level			ID 2452
Minimum value:	MinFreq Hz	Maximum value:	MaxFreq Hz	Default value: 0.00 Hz
Description:	Defines the level of which the unit value is used to look at to go into the sleep mode. When the unit drops below this level for the sleep delay time, it will put the drive into the sleep mode.			
P7.2.3.7^②	SP2 sleep mode over cycle time			ID 1844
Minimum value:	0	Maximum value:	10	Default value: 0
Description:	Defines the count the drive come in and out of sleep mode. If multiple times done in this time frame, the drive would trip on "pump over cycle" fault. One cycle is defined when the drive transfers from normal mode to sleep mode. 0 value means do not do the sleep over cycle check and clear "pump over cycle" fault.			
P7.2.3.8^②	SP2 sleep mode maximum cycle time			ID 1845
Minimum value:	0 s	Maximum value:	3,600 s	Default value: 300 s
Description:	Defines the maximum time for sleep over cycle checking.			

^① Parameter value can only be changed after the drive has stopped.

^② Parameter value will be set to be default when changing macros.

Chapter 7- Multi-purpose application

Table 64. Feedback.

P7.3.1 - Standard.				
P7.3.1.1 ^②	PI feedback gain			ID 1331
Minimum value:	-1,000.0%	Maximum value:	1,000.0%	Default value: 100.0%
Description:	Defines gain associated with the feedback signal from the measuring device.			
P7.3.2 - Feedback 1.				
P7.3.2.1 ^①	PI feedback 1 source			ID 1332
Minimum value:	N.A.	Maximum value:	N.A.	Default value: 2
Options:	0 = Not used; 1 = AI; 2 = Drive reference pot; 3 = FB process data input 1; 4 = FB Process Data Input 2; 5 = FB Process Data Input 3; 6 = FB Process Data Input 4; 7 = FB Process Data Input 5; 8 = FB Process Data Input 6; 9 = FB Process Data Input 7; 10 = FB Process Data Input 8; or 11 = FB PI feedback.			
Description:	Defines where feedback signal is being fed into the drive, via analog or fieldbus data value.			
P7.3.2.2 ^②	PI feedback 1 minimum			ID 1333
Minimum value:	-200.00 %	Maximum value:	200.00%	Default value: 0.00%
Description:	Minimum unit value for the feedback signal.			
P7.3.2.3 ^②	PI feedback 1 maximim			ID 1334
Minimum value:	-200.00 %	Maximum value:	200.00%	Default value: 100.00%
Description:	Maximim unit value for the feedback signal.			

^① Parameter value can only be changed after the drive has stopped.

^② Parameter value will be set to be default when changing macros.

Table 65. HVAC parameters.

P8.1 - Damper (*DM1 PRO).				
P8.1.1 ^{①②}	Damper start			ID 483
Minimum value:	N.A.	Maximum value:	N.A.	Default value: 0
Options:	0 = Start - standard start. 1 = Interlocked start: To use this, a relay output, RO1/RO2, needs to be programmed for selections 29 "Damper Control" and a digital input function must be programmed for selection "RunEnable". The relay output is used to energize an element of the driven system, such as a damper, seal water solenoid, or a pre-lube pump. Upon a return acknowledgement of contact closure to the programmed digital input, the frequency converter will start. 2 = Interlock time start: This functions the same as the interlocked start, except that if the return acknowledgement contact is not received within the interlock timeout, a "prevent-up start" fault is displayed in keypad and the start sequence will need to be restarted. 3 = Delay start: This start is similar to the interlocked start, except that a return contact is not used. After the "Delay Time" following the relay output closure, the frequency converter starts.			
Description:	This parameter determines the function of the damper.			
P8.1.2 ^{①②}	Damper time out			ID 484
Minimum value:	1 s	Maximum value:	32,500 s	Default value: 5 s
Description:	The time out time used for an interlocked time start, after which the start sequence must be restarted if no acknowledgement contact is received.			
P8.1.3 ^{①②}	Damper delay			ID 485
Minimum value:	1 s	Maximum value:	32,500 s	Default value: 5 s
Description:	The delay time following a delay start, after which the frequency converter will be started.			

Table 65. HVAC parameters (Cont.).

P8.2 - Fire mode (*DM1 PRO).					
P8.2.1 ^{①②}	Fire mode protection				ID 535
Minimum value:	N.A.	Maximum value:	N.A.	Default value:	0
Options:	0 = Closing contact initiates fire mode function. 1 = Opening contact initiates fire mode function.				
Description:	This parameter determines whether the fire mode function is determined by a contact closure or contact opening on the desired digital input function select fire mode. Note: When fire mode is enabled, this causes the drive to ignore any fault and run till its death. Warranty will be non-valid in the case this is enabled and the drive causes issues to the system.				
P8.2.2 ^{①②}	Fire mode reference select function				ID 536
Minimum value:	N.A.	Maximum value:	N.A.	Default value:	0
Options:	0 = Fire mode minimum frequency; 1 = Fire mode reference; 2 = Fieldbus reference - reference from fieldbus process in; 3 = AI; or 4 = PI1 control - follows the PI control algorithm settings.				
Description:	This parameter allows for setting the reference location for when the fire mode is enabled.				
P8.2.3 ^②	Fire mode minimum frequency				ID 537
Minimum value:	MinFreq. Hz	Maximum value:	MaxFreq. Hz	Default value:	15.00
Description:	This parameter sets the minimum output frequency for fire mode. This can be used as a selection for reference command.				
P8.2.4 ^②	Fire mode frequency reference 1				ID 565
Minimum value:	0.0%	Maximum value:	100.0%	Default value:	75.0%
Description:	This parameter sets the drive operating percentage based off the 0% being minimum frequency (P1.1) and 100% being maximum frequency (P1.2) for fire mode reference 1.				
P8.2.5 ^②	Fire mode frequency reference 2				ID 564
Minimum value:	0.0%	Maximum value:	100.0%	Default value:	100.0%
Description:	This parameter sets the drive operating percentage based off the 0% being minimum frequency (P1.1) and 100% being maximum frequency (P1.2) for fire mode reference 2.				
P8.2.6	Fire mode test enable				ID 2443
Minimum value:	N.A.	Maximum value:	N.A.	Default value:	N.A.
Options:	0 = Disabled; or 1 = Enabled.				
Description:	This parameter allows for testing the fire mode feature. With the parameter set to enable and fire mode input enabled, the drive will run at the fire mode speed desired but all faults are enabled.				
P8.2.7 ^{①②}	Smoke purge frequency				ID 554
Minimum value:	0.0%	Maximum value:	100.0%	Default value:	50.0%
Description:	Frequency setting for smoke purge. Preset speed used for a digital input selection. The percentage is based off the 0% being minimum frequency (P1.1) and 100% being maximum frequency (P1.2).				
P8.3 - Protections (*DM1 PRO).					
P8.3.1 ^{①②}	Broken belt protection				ID 317
Minimum value:	N.A.	Maximum value:	N.A.	Default value:	0
Options:	0 = No action; 1 = Warning; 2 = Fault - stop mode after fault according to parameter stop mode; or 3 = Fault - stop mode after fault always by coasting.				
Description:	If fault is set as the function, the drive will stop and activate the fault stage based on the parameter conditions and the monitoring status of the motor. If the motor torque drops below the Fnom and F0 torque levels for the time limit, the protection is enabled. Deactivating the protection by setting the parameter to 0 will reset the underload time counter to zero.				

Table 65. HVAC parameters (Cont.)

P8.3.2^①	Broken belt Fnom torque			ID 318
Minimum value:	10.0%	Maximum value:	150.0%	Default value: 50.0%
Description:	The torque limit can be set between 10.0-150.0 % x TnMotor. This parameter gives the value for the minimum torque allowed when the output frequency is at or above the field weakening point. If you change P1.6, nominal motor current, this parameter is automatically restored to the default value.			

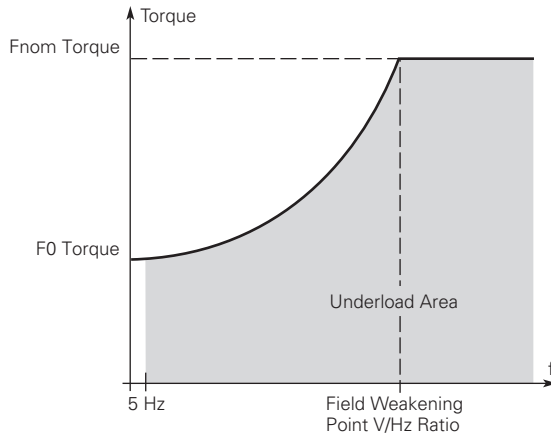

P8.3.3^①	Broken belt F0 torque			ID 319
Minimum value:	5.0%	Maximum value:	150.0%	Default value: 10.0%
Description:	The torque limit can be set between 5.0–150.0 % x TnMotor. This parameter gives the value for the minimum torque allowed at zero frequency. If you change the value of P1.6, nominal motor current, this parameter is automatically restored to the default value.			

P8.3.4^①	Broken belt time limit			ID 320
Minimum value:	2.00 s	Maximum value:	600.00 s	Default value: 20.00 s
Description:	This time can be set between 2.00 and 600.00 seconds. This is the time allowed for a fault state to exist. An internal up/down counter counts the accumulated underload time. If the underload counter value goes above this limit, the protection will cause a trip according to protection parameter. If the drive is stopped, the counter is reset to zero.			

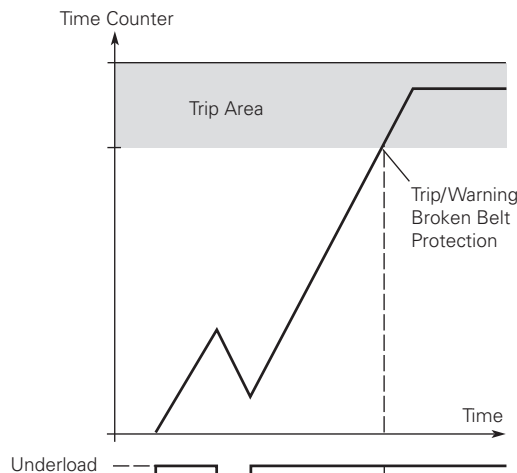

^① Parameter value can only be changed after the drive has stopped.
^② Parameter value will be set to be default when changing macros.

Table 66. Pump parameters.

P9.1 - Derag (*DM1 PRO).				
P9.1.1^②	Derag cycles			ID 2468
Minimum value:	0	Maximum value:	10	Default value: 3
Description:	This parameter defines the number of cycles in the forward/reverse direction for removing any debris in system.			
P9.1.2^②	Derag at Start/Stop			ID 2469
Minimum value:	N.A.	Maximum value:	N.A.	Default value: 0
Options:	0 = Off; 1 = Start; 2 = Stop; 3 = Start and stop; 4 = Digital input; or 5 = Current.			
Description:	Defines how the derage function will become activated; start, stop, both, or based off the digital input.			
P9.1.3^②	Deragging run time			ID 2470
Minimum value:	1 s	Maximum value:	3,600 s	Default value: 0 s
Description:	Defines the length of time the drive will run at the derag speed in the forward and reverse direction.			
P9.1.4^②	Derag speed			ID 2471
Minimum value:	MinFreq Hz	Maximum value:	MaxFreq Hz	Default value: 5.00 Hz
Description:	Defines the frequency the drive will run at in the forward/reverse direction when in the derag mode.			
P9.1.5^②	Derag off delay			ID 2472
Minimum value:	1 s	Maximum value:	600 s	Default value: 10 s
Description:	Defines the length of time the drive will run the derag function when enabled at stop.			
P9.1.6^{①②}	Derag current			ID 1879
Minimum value:	N.A. A	Maximum value:	N.A. A	Default value: 0.00 A
P9.2 - Start/stop timing (*DM1 PRO).				
P9.2.1^{①②}	Valve start			ID 1847
Minimum value:	N.A.	Maximum value:	N.A.	Default value: 0
Options:	0 = Normal; 1 = Damper start; 2 = Damper tout; 3 = Damper delay.			
Description:	This parameter determines the function of damper.			
P9.2.2^{①②}	Valve timeout			ID 1848
Minimum value:	1 s	Maximum value:	32,500 s	Default value: 5 s
Description:	The timeout time used for an interlocked time start, after which the start sequence must be restarted if no acknowledgement contact is received.			
P9.2.3^{①②}	Valve delay			ID 1849
Minimum value:	1 s	Maximum value:	32,500 s	Default value: 5 s
Description:	The delay time following a delay start, after which the frequency converter will be started.			

Chapter 7- Multi-purpose application

Table 66. Pump parameters (Cont.).

P9.2.4 ^{①②}	Back spin delay			ID 2423
Minimum value:	0 s	Maximum value:	32,500 s	Default value: 0 s
Description:	Run delay time parameter sets the time required for the drive to wait before another run command can be received. During this time, the run signal is given. It is ignored until the time has expired upon which it will then start. This is true for keypad, I/O, or Fieldbus Control places.			
P9.2.5 ^{①②}	Minimum run time			ID 1813
Minimum value:	0 s	Maximum value:	32,500 s	Default value: 0 s
Description:	Drive minimum run time.			
P9.2.6 ^②	Minimum frequency ramp time			ID 1850
Minimum value:	0.1 s	Maximum value:	2,000.0 s	Default value: 10.0 s
Description:	Ramp time for output to minimum frequency.			
P9.3 - Multi-pump multi-drive (*DM1 PRO).				
P9.3.1 ^{①②}	Multi-pump mode			ID 2279
Minimum value:	N.A.	Maximum value:	N.A.	Default value: 0
Options:	0 = Disabled or 1 = Multi-drive network.			
Description:	Determines the number of drives being used in the multi-pump configuration: 0 = Disabled - single drive for motor; or 1 = Multi-drive - multi-follower sequence with multiple drives.			
P9.3.2 ^{①②}	Number of drives			ID 2449
Minimum value:	1	Maximum value:	5	Default value: 1
Description:	This defines the number of drives active when doing the multi-drive pump and fan scheme. By default, there will be always one drive active at one time. By setting value to above one, it allows for bringing in additional drives to maintain the system.			
P9.3.3 ^{①②}	Drive ID			ID 2278
Minimum value:	0	Maximum value:	5	Default value: 0
Description:	This parameter defines the drive address when using multi- drive pump mode. Based off this ID, the drive enables in the desired sequence and can be monitored at this drive ID value in the monitor screen.			
P9.3.4 ^{①②}	Regulation source			ID 2284
Minimum value:	N.A.	Maximum value:	N.A.	Default value: 0
Options:	0 = Network only; or 1 = PI controller.			
Description:	For drives that have been connected with both start/stop signal and PI feedback - can be set up as "Feedback", so they will have ability to be the master.			
P9.3.5 ^②	PI bandwidth			ID 2458
Minimum value:	0.00 varies	Maximum value:	6,000.00 varies	Default value: 10.00 varies
Description:	Percentage based off the setpoint above and below which defines when the auxiliary motor will come online or offline.			
P9.3.6 ^{①②}	Staging frequency			ID 2315
Minimum value:	MinFreq	Maximum value:	400.00	Default value: 50.00
Description:	Output frequency is above staging frequency and PI error is out of PI bandwidth - motor should add to system.			
P9.3.7 ^{①②}	De-staging frequency			ID 2316
Minimum value:	0.00	Maximum value:	MaxFreq	Default value: 0.00
Description:	Output frequency is below de-staging frequency and PI error is out of PI bandwidth - motor should remove from system.			
P9.3.8 ^②	Add/remove delay			ID 344
Minimum value:	0 s	Maximum value:	3,600 s	Default value: 10 s
Description:	With feedback outside the bandwidth, this time must pass before motors/pumps are added or removed from the system.			

Table 66. Pump parameters (Cont.).

P9.3.9^②	Interlock enabled			ID 350
Minimum value:	N.A.	Maximum value:	N.A.	Default value: 0
Options:	0 = Disabled; or 1 = Enabled.			
Description:	This parameter enables the drive to look at the digital input interlocks to tell which motor is available for running or if they were brought offline.			
P9.3.10^{①②}	Recovery method			ID 2285
Minimum value:	N.A.	Maximum value:	N.A.	Default value: 0
Options:	0 = Automatic; or 1 = Stop.			
Description:	This parameter is for the slave when multi-drive system lost the master. The slave drive can continue run if it set to be "Automatic". However, the slave drive will stop immediately if it is set to be "Stop".			
P9.3.11^②	Add/remove drive selection			ID 2311
Minimum value:	N.A.	Maximum value:	N.A.	Default value: 0
Options:	0 = Drive ID; or 1 = Run time.			
Description:	In default, MPFC system will add/remove pump according to their drive ID, from small to large. The order can also depend on each slave drive's running time: add the drive that has shortest running time and remove the drive that has longest running time first.			
P9.3.12^②	Run time enabled			ID 2280
Minimum value:	N.A.	Maximum value:	N.A.	Default value: 0
Options:	0 = Disabled; or 1 = Enabled.			
Description:	The run time counter will start counting only if this parameter is enabled.			
P9.3.13^②	Run time limit			ID 2281
Minimum value:	0.0 h	Maximum value:	300,000.0 h	Default value: 0.0 h
Description:	If drive run time is over this limit, its network status will be "Need Alternation". Limit equals 0 means run time counter disabled.			
P9.3.14	Run time reset			ID 2283
Minimum value:	N.A.	Maximum value:	N.A.	Default value: N.A.
Options:	0 = No action; or 1 = Reset.			
Description:	One-time parameter, set to be 1 will clear run time counter.			
P9.3.15^②	Master drive mode			ID 2473
Minimum value:	N.A.	Maximum value:	N.A.	Default value: 0
Options:	0 = Follow PI; 1 = Fixed speed; or 2 = Turn off.			
Description:	Defines how the master drive will maintain the frequency control when slaves are brought in; follow PI, fixed speed, or turn off.			
P9.3.16^②	Master fixed speed			ID 2474
Minimum value:	MinFreq Hz	Maximum value:	MaxFreq Hz	Default value: 50.00 Hz
Description:	Defines the fixed speed frequency when the master drive mode is set for fixed speed control when slaves are brought in.			
P9.3.17^②	Master fixed speed delay			ID 2475
Minimum value:	0 s	Maximum value:	1,000 s	Default value: 5 s
Description:	Defines the delay time before the master drive begins running at the fixed speed or turns off if the master mode is set for fixed speed or turn off.			

Chapter 7- Multi-purpose application

Table 66. Pump parameters (Cont.).

P9.4 - Pipe fill (Loss of prime) (*DM1 PRO).					
P9.4.1 ^{①②}	Pipe fill loss response				ID 2410
Minimum value:	N.A.	Maximum value:	N.A.	Default value:	0
Options:	0 = No action; 1 = Warning; 2 = Fault; or 3 = Fault, coast.				
Description:	Defines the response method when a "loss of prime" condition occurs.				
P9.4.2 ^{①②}	Pipe fill loss detection method				ID 2406
Minimum value:	N.A.	Maximum value:	N.A.	Default value:	0
Options:	0 = Motor current; 1 = Motor power (%); or 2 = Motor torque (%).				
Description:	Defines the value for looking at a loss of prime.				
P9.4.3 ^②	Pipe fill loss low level				ID 2407
Minimum value:	0.00 varies	Maximum value:	1,000.00 varies	Default value:	0.00 varies
Description:	If the monitor value is less than low level value and the output frequency is more than low frequency, check the pipe fill loss start.				
P9.4.4 ^{①②}	Pipe fill loss low frequency				ID 2409
Minimum value:	0.00 Hz	Maximum value:	MaxFreq Hz	Default value:	0.00 Hz
Description:	Defines the frequency point at which the drive needs to be above to enable the "loss of prime" feature. When set to 0 Hz, protection is disabled.				
P9.4.5 ^②	Pipe fill loss high level				ID 1851
Minimum value:	0.0 varies	Maximum value:	1,000.0 varies	Default value:	0.0 varies
Description:	If the monitor value is more than high level (the high level is not 0) and the output frequency is more than high frequency, check pipe fill loss start.				
P9.4.6 ^{①②}	Pipe fill loss high frequency				ID 1852
Minimum value:	0.00 Hz	Maximum value:	MaxFreq Hz	Default value:	0.00 Hz
Description:	Defines high frequency point at which the drive needs to be above to enabled the "loss of prime" feature. When set to 0 Hz, protection is disabled.				
P9.4.7 ^②	Pipe fill loss time				ID 2408
Minimum value:	0 s	Maximum value:	600 s	Default value:	0 s
Description:	Defines the delay time before a "loss of prime" condition will occur based of the detection method and prime loss level.				
P9.4.8 ^②	Pipe fill loss attempts				ID 2411
Minimum value:	0	Maximum value:	10	Default value:	1
Description:	Defines the amount of attempts to auto restart the drive on a "prime loss" condition.				
P9.5 - Prime pump (*DM1 PRO).					
P9.5.1 ^②	Prime pump enable				ID 2428
Minimum value:	N.A.	Maximum value:	N.A.	Default value:	0
Options:	0 = Disabled; or 1 = Enabled.				
Description:	Prime pump enable.				

Table 66. Pump parameters (Cont.).

P9.5.2^②	Prime pump level			ID 2429
Minimum value:	0.00 varies	Maximum value:	6,000.00 varies	Default value: 0.00 varies
Description:	This defines the level at which the prime pump function will drop out. If the feedback level raises above this value, prime pump becomes deactivated. If the level is not reached, it will switch after the delay time.			
P9.5.3^②	Prime pump frequency			ID 2431
Minimum value:	MinFreq Hz	Maximum value:	MaxFreq Hz	Default value: 0.00 Hz
Description:	Frequency at which the prime pump function will operate when enabled.			
P9.5.4^②	Prime pump delay time			ID 2432
Minimum value:	0 min.	Maximum value:	3,600 min.	Default value: 0 min.
Description:	This is the time that the drive will run the pre-charge function on start up.			
P9.5.5^②	Prime pump loss of prime level			ID 2433
Minimum value:	0.00 varies	Maximum value:	1,000.00 varies	Default value: 0.00 varies
Description:	Selects the limit to indicate a loss of prime in pump. If the measured current drops below the determined value for the value assigned in the prime loss of time setting, the drive will display "pipe fill loss".			
P9.5.6^②	Prime pump level 2			ID 2434
Minimum value:	0.00 varies	Maximum value:	6,000.00 varies	Default value: 0.00 varies
Description:	This defines the level at which the prime pump function will drop out. If the feedback level raises above this value, prime pump becomes deactivated. If the level is not reached, it will switch after the delay time.			
P9.5.7^②	Prime pump frequency 2			ID 2436
Minimum value:	MinFreq Hz	Maximum value:	MaxFreq Hz	Default value: 0.00 Hz
Description:	Frequency at which the prime pump level 2 will operate at when enabled.			
P9.5.8^②	Prime pump delay time 2			ID 2437
Minimum value:	0.0 min	Maximum value:	3,600.0 min	Default value: 0.0 min
Description:	This is the time that the drive will run at the 2nd level prime pump function level.			
P9.5.9^②	Prime pump loss of prime level 2			ID 2438
Minimum value:	0.00 varies	Maximum value:	1,000.00 varies	Default value: 0.00 varies
Description:	Selects the limit to indicate a loss of prime in pump. If the measured current drops below the determined value for the value assigned in the prime loss of time setting, the drive will display pipe fill loss.			
P9.6 - Broken pipe (*DM1 PRO).				
P9.6.1^{①②}	Broken pipe fault response			ID 1853
Minimum value:	N.A.	Maximum value:	N.A.	Default value: 0
Options:	0 = No action; 1 = Warning; 2 = Fault, coast; or 3 = Fault.			
Description:	Broken pipe fault/warning shall be triggered if the PI feedback is less than broken pipe level and the drive output frequency is more than broke pipe frequency for delay time.			
P9.6.2^②	Broken pipe level			ID 1854
Minimum value:	0.0 varies	Maximum value:	6,000.0 varies	Default value: 15.0 varies
Description:	Broken pipe level.			
P9.6.3^②	Broken pipe frequency			ID 1856
Minimum value:	1.00 Hz	Maximum value:	MaxFreq Hz	Default value: 25.00 Hz
Description:	Broken pipe frequency.			

Table 66. Pump parameters (Cont.).

P9.6.4 ^①	Broken pipe delay			ID 1855
Minimum value:	1.0 s	Maximum value:	120.0 s	Default value: 15.0 s
Description:	Broken pipe delay time.			

① Parameter value can only be changed after the drive has stopped.

② Parameter value will be set to be default when changing macros.

Table 67. Fieldbus (FB) status .

P10.1 - FB process data input selection.				
P10.1.1 ^②	FB process data input 1 selection			ID 2533
Minimum value:	0	Maximum value:	12,464	Default value: 0
Description:	<p>With the fieldbus data output selections, parameter/monitor IDs can be assigned to these registers and then read over the desired fieldbus network word for process data. Any drive parameter with an ID can be read over these values.</p> <p>Default values for process data in: Process data IN1 = NULL = ID 0; Process data IN2 = FB PI Set Point1= ID 2542; Process data IN3 = FB PI Feedback1= ID 2550; Process data IN4 = Acceleration time 1= ID 103; Process data IN5 = Deceleration time 1= ID 104; Process data IN6 = Current limit= ID 107; Process data IN7 = NULL= ID 0; or Process data IN8 = NULL= ID 0.</p>			
P10.1.2 ^②	FB process data input 2 selection			ID 2534
Minimum value:	0	Maximum value:	12,464	Default value: 2,542
Description:	<p>With the fieldbus data output selections, parameter/monitor IDs can be assigned to these registers and then read over the desired fieldbus network word for process data. Any drive parameter with an ID can be read over these values.</p> <p>Default values for process data in: Process data IN1 = NULL = ID 0; Process data IN2 = FB PI Set Point1= ID 2542; Process data IN3 = FB PI Feedback1= ID 2550; Process data IN4 = Acceleration time 1= ID 103; Process data IN5 = Deceleration time 1= ID 104; Process data IN6 = Current limit= ID 107; Process data IN7 = NULL= ID 0; or Process data IN8 = NULL= ID 0.</p>			
P10.1.3 ^②	FB process data input 3 selection			ID 2535
Minimum value:	0	Maximum value:	12,464	Default value: 2,550
Description:	<p>With the fieldbus data output selections, parameter/monitor IDs can be assigned to these registers and then read over the desired fieldbus network word for process data. Any drive parameter with an ID can be read over these values.</p> <p>Default values for process data in: Process data IN1 = NULL = ID 0; Process data IN2 = FB PI Set Point1= ID 2542; Process data IN3 = FB PI Feedback1= ID 2550; Process data IN4 = Acceleration time 1= ID 103; Process data IN5 = Deceleration time 1= ID 104; Process data IN6 = Current limit= ID 107; Process data IN7 = NULL= ID 0; or Process data IN8 = NULL= ID 0.</p>			

Table 67. Fieldbus (FB) status (Cont.).

P10.1.4^②	FB process data input 4 selection			ID 2536
Minimum value:	0	Maximum value:	12,464	Default value: 103
Description:	<p>With the fieldbus data output selections, parameter/monitor IDs can be assigned to these registers and then read over the desired fieldbus network word for process data. Any drive parameter with an ID can be read over these values.</p> <p>Default values for process data in: Process data IN1 = NULL = ID 0; Process data IN2 = FB PI Set Point1= ID 2542; Process data IN3 = FB PI Feedback1= ID 2550; Process data IN4 = Acceleration time 1= ID 103; Process data IN5 = Deceleration time 1= ID 104; Process data IN6 = Current limit= ID 107; Process data IN7 = NULL= ID 0; or Process data IN8 = NULL= ID 0.</p>			
P10.1.5^②	FB process data input 5 selection			ID 2537
Minimum value:	0	Maximum value:	12,464	Default value: 104
Description:	<p>With the fieldbus data output selections, parameter/monitor IDs can be assigned to these registers and then read over the desired fieldbus network word for process data. Any drive parameter with an ID can be read over these values.</p> <p>Default values for process data in: Process data IN1 = NULL = ID 0; Process data IN2 = FB PI Set Point1= ID 2542; Process data IN3 = FB PI Feedback1= ID 2550; Process data IN4 = Acceleration time 1= ID 103; Process data IN5 = Deceleration time 1= ID 104; Process data IN6 = Current limit= ID 107; Process data IN7 = NULL= ID 0; or Process data IN8 = NULL= ID 0.</p>			
P10.1.6^②	FB process data input 6 selection			ID 2538
Minimum value:	0	Maximum value:	12,464	Default value: 107
Description:	<p>With the fieldbus data output selections, parameter/monitor IDs can be assigned to these registers and then read over the desired fieldbus network word for process data. Any drive parameter with an ID can be read over these values.</p> <p>Default values for process data in: Process data IN1 = NULL = ID 0; Process data IN2 = FB PI Set Point1= ID 2542; Process data IN3 = FB PI Feedback1= ID 2550; Process data IN4 = Acceleration time 1= ID 103; Process data IN5 = Deceleration time 1= ID 104; Process data IN6 = Current limit= ID 107; Process data IN7 = NULL= ID 0; or Process data IN8 = NULL= ID 0.</p>			
P10.1.7^②	FB process data input 7 selection			ID 2539
Minimum value:	0	Maximum value:	12,464	Default value: 0
Description:	<p>With the fieldbus data output selections, parameter/monitor IDs can be assigned to these registers and then read over the desired fieldbus network word for process data. Any drive parameter with an ID can be read over these values.</p> <p>Default values for process data in: Process data IN1 = NULL = ID 0; Process data IN2 = FB PI Set Point1= ID 2542; Process data IN3 = FB PI Feedback1= ID 2550; Process data IN4 = Acceleration time 1= ID 103; Process data IN5 = Deceleration time 1= ID 104; Process data IN6 = Current limit= ID 107; Process data IN7 = NULL= ID 0; or Process data IN8 = NULL= ID 0.</p>			

Chapter 7- Multi-purpose application

Table 67. Fieldbus (FB) status (Cont.).

P10.1.8^②	FB process data input 8 selection			ID 2540
Minimum value:	0	Maximum value:	12,464	Default value: 0
Description:	<p>With the fieldbus data output selections, parameter/monitor IDs can be assigned to these registers and then read over the desired fieldbus network word for process data. Any drive parameter with an ID can be read over these values.</p> <p>Default values for process data in: Process data IN1 = NULL = ID 0; Process data IN2 = FB PI Set Point1= ID 2542; Process data IN3 = FB PI Feedback1= ID 2550; Process data IN4 = Acceleration time 1= ID 103; Process data IN5 = Deceleration time 1= ID 104; Process data IN6 = Current limit= ID 107; Process data IN7 = NULL= ID 0; or Process data IN8 = NULL= ID 0.</p>			
P10.2 - FB process data output selection.				
P10.2.1^②	FB process data output 1 selection			ID 1556
Minimum value:	N.A.	Maximum value:	N.A.	Default value: 1
Description:	<p>With the fieldbus data output selections, parameter/monitor IDs can be assigned to these registers and then read over the desired fieldbus network word for process data. Any drive parameter with an ID can be read over these values.</p> <p>Default values for process data out in fieldbus (build table for below values): Process data Out1 = Output frequency = ID 1; Process data Out2 = Motor speed = ID 2; Process data Out3 = Motor current = ID 3; Process data Out4 = Motor torque = ID 4; Process data Out5 = Motor power = ID 5; Process data Out6 = Motor voltage = ID 6; Process data Out7 = DC link voltage = ID 7; or Process data Out8 = Latest fault code = ID 28.</p>			
P10.2.2^②	FB process data output 2 selection			ID 1557
Minimum value:	N.A.	Maximum value:	N.A.	Default value: 2
Description:	<p>With the fieldbus data output selections, parameter/monitor IDs can be assigned to these registers and then read over the desired fieldbus network word for process data. Any drive parameter with an ID can be read over these values.</p> <p>Default values for process data out in fieldbus (build table for below values): Process data Out1 = Output frequency = ID 1; Process data Out2 = Motor speed = ID 2; Process data Out3 = Motor current = ID 3; Process data Out4 = Motor torque = ID 4; Process data Out5 = Motor power = ID 5; Process data Out6 = Motor voltage = ID 6; Process data Out7 = DC link voltage = ID 7; or Process data Out8 = Latest fault code = ID 28.</p>			
P10.2.3^②	FB process data output 3 selection			ID 1558
Minimum value:	N.A.	Maximum value:	N.A.	Default value: 3
Description:	<p>With the fieldbus data output selections, parameter/monitor IDs can be assigned to these registers and then read over the desired fieldbus network word for process data. Any drive parameter with an ID can be read over these values.</p> <p>Default values for process data out in fieldbus (build table for below values): Process data Out1 = Output frequency = ID 1; Process data Out2 = Motor speed = ID 2; Process data Out3 = Motor current = ID 3; Process data Out4 = Motor torque = ID 4; Process data Out5 = Motor power = ID 5; Process data Out6 = Motor voltage = ID 6; Process data Out7 = DC link voltage = ID 7; or Process data Out8 = Latest fault code = ID 28.</p>			

Table 67. Fieldbus (FB) status (Cont.).

P10.2.4^②	FB process data output 4 selection			ID 1559
Minimum value:	N.A.	Maximum value:	N.A.	Default value: 4
Description:	<p>With the fieldbus data output selections, parameter/monitor IDs can be assigned to these registers and then read over the desired fieldbus network word for process data. Any drive parameter with an ID can be read over these values.</p> <p>Default values for process data out in fieldbus (build table for below values): Process data Out1 = Output frequency = ID 1; Process data Out2 = Motor speed = ID 2; Process data Out3 = Motor current = ID 3; Process data Out4 = Motor torque = ID 4; Process data Out5 = Motor power = ID 5; Process data Out6 = Motor voltage = ID 6; Process data Out7 = DC link voltage = ID 7; or Process data Out8 = Latest fault code = ID 28.</p>			
P10.2.5^②	FB process data output 5 selection			ID 1560
Minimum value:	N.A.	Maximum value:	N.A.	Default value: 5
Description:	<p>With the fieldbus data output selections, parameter/monitor IDs can be assigned to these registers and then read over the desired fieldbus network word for process data. Any drive parameter with an ID can be read over these values.</p> <p>Default values for process data out in fieldbus (build table for below values): Process data Out1 = Output frequency = ID 1; Process data Out2 = Motor speed = ID 2; Process data Out3 = Motor current = ID 3; Process data Out4 = Motor torque = ID 4; Process data Out5 = Motor power = ID 5; Process data Out6 = Motor voltage = ID 6; Process data Out7 = DC link voltage = ID 7; or Process data Out8 = Latest fault code = ID 28.</p>			
P10.2.6^②	FB process data output 6 selection			ID 1561
Minimum value:	N.A.	Maximum value:	N.A.	Default value: 6
Description:	<p>With the fieldbus data output selections, parameter/monitor IDs can be assigned to these registers and then read over the desired fieldbus network word for process data. Any drive parameter with an ID can be read over these values.</p> <p>Default values for process data out in fieldbus (build table for below values): Process data Out1 = Output frequency = ID 1; Process data Out2 = Motor speed = ID 2; Process data Out3 = Motor current = ID 3; Process data Out4 = Motor torque = ID 4; Process data Out5 = Motor power = ID 5; Process data Out6 = Motor voltage = ID 6; Process data Out7 = DC link voltage = ID 7; or Process data Out8 = Latest fault code = ID 28.</p>			
P10.2.7^②	FB process data output 7 selection			ID 1562
Minimum value:	N.A.	Maximum value:	N.A.	Default value: 7
Description:	<p>With the fieldbus data output selections, parameter/monitor IDs can be assigned to these registers and then read over the desired fieldbus network word for process data. Any drive parameter with an ID can be read over these values.</p> <p>Default values for process data out in fieldbus (build table for below values): Process data Out1 = Output frequency = ID 1; Process data Out2 = Motor speed = ID 2; Process data Out3 = Motor current = ID 3; Process data Out4 = Motor torque = ID 4; Process data Out5 = Motor power = ID 5; Process data Out6 = Motor voltage = ID 6; Process data Out7 = DC link voltage = ID 7; or Process data Out8 = Latest fault code = ID 28.</p>			

Chapter 7- Multi-purpose application

Table 67. Fieldbus (FB) status (Cont.).

P10.2.8^②	FB process data output 8 selection			ID 1563
Minimum value:	N.A.	Maximum value:	N.A.	Default value: 28
Description:	<p>With the fieldbus data output selections, parameter/monitor IDs can be assigned to these registers and then read over the desired fieldbus network word for process data. Any drive parameter with an ID can be read over these values.</p> <p>Default values for process data out in fieldbus (build table for below values): Process data Out1 = Output frequency = ID 1; Process data Out2 = Motor speed = ID 2; Process data Out3 = Motor current = ID 3; Process data Out4 = Motor torque = ID 4; Process data Out5 = Motor power = ID 5; Process data Out6 = Motor voltage = ID 6; Process data Out7 = DC link voltage = ID 7; or Process data Out8 = Latest fault code = ID 28.</p>			
P10.3 - Standard status word.				
P10.3.1^②	Standard status word Bit0 function select			ID 2415
Minimum value:	N.A.	Maximum value:	N.A.	Default value: 1
Options:	<p>0 = Not used; 1 = Ready; 2 = Run; 3 = Fault; 4 = Fault invert; 5 = Warning; 6 = Reversed; 7 = At speed; 8 = Zero frequency; 9 = Frequency limit supervision; 10 = PI supervision; 11 = Torque limit supervision; 12 = Reference limit supervision; 13 = Power limit supervision; 14 = Temperature limit supervision; 15 = Analog input supervision; 16 = Motor current supervision; 17 = Over heat fault; 18 = Overcurrent regular; 19 = Overvoltage regular; 20 = Undervoltage regular; 21 = 4 mA reference fault/warning; 22 = External fault/warning; 23 = Motor thermal protection; 24 = STO fault output; 25 = Control from I/O; 26 = Remote control; 27 = Un-requested rotation direction; 28 = Fire mode; 29 = Damper control; 30 = Valve control; 31 = Jog speed select; 32 = Fieldbus digital input 1; 33 = Fieldbus digital input 2; 34 = DC charge switch close; 35 = Preheat active; 36 = Cold weather active; 37 = PI Sleep 38 = 2nd stage ramp frequency active; 39 = Prime pump active; 40 = Master drive state; 41 = Slave drive state; or 43 = Single drive control.</p>			
Description:	<p>This parameter allows for setting one of the RO functions to a status word that then can be read over the communication standard status word. This also can be viewed in the keypad monitor value M5.3.</p>			

Table 67. Fieldbus (FB) status (Cont.).

P10.3.2^②	Standard status word Bit 1 function select			ID 2416
Minimum value:	N.A.	Maximum value:	N.A.	Default value: 2
Options:	0 = Not used; 1 = Ready; 2 = Run; 3 = Fault; 4 = Fault invert; 5 = Warning; 6 = Reversed; 7 = At speed; 8 = Zero frequency; 9 = Frequency limit supervision; 10 = PI supervision; 11 = Torque limit supervision; 12 = Reference limit supervision; 13 = Power limit supervision; 14 = Temperature limit supervision; 15 = Analog input supervision; 16 = Motor current supervision; 17 = Over heat fault; 18 = Overcurrent regular; 19 = Overvoltage regular; 20 = Undervoltage regular; 21 = 4 mA reference fault/warning; 22 = External fault/warning; 23 = Motor thermal protection; 24 = STO fault output; 25 = Control from I/O; 26 = Remote control; 27 = Un-requested rotation direction; 28 = Fire mode; 29 = Damper control; 30 = Valve control; 31 = Jog speed select; 32 = Fieldbus digital input 1; 33 = Fieldbus digital input 2; 34 = DC charge switch close; 35 = Preheat active; 36 = Cold weather active; 37 = PI Sleep 38 = 2nd stage ramp frequency active; 39 = Prime pump active; 40 = Master drive state; 41 = Slave drive state; or 43 = Single drive control.			
Description:	This parameter allows for setting one of the RO functions to a status word that then can be read over the communication standard status word. This also can be viewed in the keypad monitor value M5.3.			

Table 67. Fieldbus (FB) status (Cont.).

P10.3.3^②	Standard status word Bit 2 function select			ID 2417
Minimum value:	N.A.	Maximum value:	N.A.	Default value: 3
Options:	0 = Not used; 1 = Ready; 2 = Run; 3 = Fault; 4 = Fault invert; 5 = Warning; 6 = Reversed; 7 = At speed; 8 = Zero frequency; 9 = Frequency limit supervision; 10 = PI supervision; 11 = Torque limit supervision; 12 = Reference limit supervision; 13 = Power limit supervision; 14 = Temperature limit supervision; 15 = Analog input supervision; 16 = Motor current supervision; 17 = Over heat fault; 18 = Overcurrent regular; 19 = Overvoltage regular; 20 = Undervoltage regular; 21 = 4 mA reference fault/warning; 22 = External fault/warning; 23 = Motor thermal protection; 24 = STO fault output; 25 = Control from I/O; 26 = Remote control; 27 = Un-requested rotation direction; 28 = Fire mode; 29 = Damper control; 30 = Valve control; 31 = Jog speed select; 32 = Fieldbus digital input 1; 33 = Fieldbus digital input 2; 34 = DC charge switch close; 35 = Preheat active; 36 = Cold weather active; 37 = PI Sleep 38 = 2nd stage ramp frequency active; 39 = Prime pump active; 40 = Master drive state; 41 = Slave drive state; or 43 = Single drive control.			
Description:	This parameter allows for setting one of the RO functions to a status word that then can be read over the communication standard status word. This also can be viewed in the keypad monitor value M5.3.			

Table 67. Fieldbus (FB) status (Cont.).

P10.3.4 ^②	<i>Standard status word Bit 3 function select</i>			ID 2418
Minimum value:	N.A.	Maximum value:	N.A.	Default value: 4
Options:	0 = Not used; 1 = Ready; 2 = Run; 3 = Fault; 4 = Fault invert; 5 = Warning; 6 = Reversed; 7 = At speed; 8 = Zero frequency; 9 = Frequency limit supervision; 10 = PI supervision; 11 = Torque limit supervision; 12 = Reference limit supervision; 13 = Power limit supervision; 14 = Temperature limit supervision; 15 = Analog input supervision; 16 = Motor current supervision; 17 = Over heat fault; 18 = Overcurrent regular; 19 = Overvoltage regular; 20 = Undervoltage regular; 21 = 4 mA reference fault/warning; 22 = External fault/warning; 23 = Motor thermal protection; 24 = STO fault output; 25 = Control from I/O; 26 = Remote control; 27 = Un-requested rotation direction; 28 = Fire mode; 29 = Damper control; 30 = Valve control; 31 = Jog speed select; 32 = Fieldbus digital input 1; 33 = Fieldbus digital input 2; 34 = DC charge switch close; 35 = Preheat active; 36 = Cold weather active; 37 = PI Sleep 38 = 2nd stage ramp frequency active; 39 = Prime pump active; 40 = Master drive state; 41 = Slave drive state; or 43 = Single drive control.			
Description:	This parameter allows for setting one of the RO functions to a status word that then can be read over the communication standard status word. This also can be viewed in the keypad monitor value M5.3.			

Table 67. Fieldbus (FB) status (Cont.).

P10.3.5^②	Standard status word Bit 4 function select			ID 2419
Minimum value:	N.A.	Maximum value:	N.A.	Default value: 5
Options:	0 = Not used; 1 = Ready; 2 = Run; 3 = Fault; 4 = Fault invert; 5 = Warning; 6 = Reversed; 7 = At speed; 8 = Zero frequency; 9 = Frequency limit supervision; 10 = PI supervision; 11 = Torque limit supervision; 12 = Reference limit supervision; 13 = Power limit supervision; 14 = Temperature limit supervision; 15 = Analog input supervision; 16 = Motor current supervision; 17 = Over heat fault; 18 = Overcurrent regular; 19 = Overvoltage regular; 20 = Undervoltage regular; 21 = 4 mA reference fault/warning; 22 = External fault/warning; 23 = Motor thermal protection; 24 = STO fault output; 25 = Control from I/O; 26 = Remote control; 27 = Un-requested rotation direction; 28 = Fire mode; 29 = Damper control; 30 = Valve control; 31 = Jog speed select; 32 = Fieldbus digital input 1; 33 = Fieldbus digital input 2; 34 = DC charge switch close; 35 = Preheat active; 36 = Cold weather active; 37 = PI Sleep 38 = 2nd stage ramp frequency active; 39 = Prime pump active; 40 = Master drive state; 41 = Slave drive state; or 43 = Single drive control.			
Description:	This parameter allows for setting one of the RO functions to a status word that then can be read over the communication standard status word. This also can be viewed in the keypad monitor value M5.3.			

Table 67. Fieldbus (FB) status (Cont.).

P10.3.6 ^②	<i>Standard status word Bit 5 function select</i>			ID 2420
Minimum value:	N.A.	Maximum value:	N.A.	Default value: 6
Options:	0 = Not used; 1 = Ready; 2 = Run; 3 = Fault; 4 = Fault invert; 5 = Warning; 6 = Reversed; 7 = At speed; 8 = Zero frequency; 9 = Frequency limit supervision; 10 = PI supervision; 11 = Torque limit supervision; 12 = Reference limit supervision; 13 = Power limit supervision; 14 = Temperature limit supervision; 15 = Analog input supervision; 16 = Motor current supervision; 17 = Over heat fault; 18 = Overcurrent regular; 19 = Overvoltage regular; 20 = Undervoltage regular; 21 = 4 mA reference fault/warning; 22 = External fault/warning; 23 = Motor thermal protection; 24 = STO fault output; 25 = Control from I/O; 26 = Remote control; 27 = Un-requested rotation direction; 28 = Fire mode; 29 = Damper control; 30 = Valve control; 31 = Jog speed select; 32 = Fieldbus digital input 1; 33 = Fieldbus digital input 2; 34 = DC charge switch close; 35 = Preheat active; 36 = Cold weather active; 37 = PI Sleep 38 = 2nd stage ramp frequency active; 39 = Prime pump active; 40 = Master drive state; 41 = Slave drive state; or 43 = Single drive control.			
Description:	This parameter allows for setting one of the RO functions to a status word that then can be read over the communication standard status word. This also can be viewed in the keypad monitor value M5.3.			

Table 67. Fieldbus (FB) status (Cont.).

P10.3.7^②	Standard status word Bit 6 function select			ID 2421
Minimum value:	N.A.	Maximum value:	N.A.	Default value: 7
Options:	0 = Not used; 1 = Ready; 2 = Run; 3 = Fault; 4 = Fault invert; 5 = Warning; 6 = Reversed; 7 = At speed; 8 = Zero frequency; 9 = Frequency limit supervision; 10 = PI supervision; 11 = Torque limit supervision; 12 = Reference limit supervision; 13 = Power limit supervision; 14 = Temperature limit supervision; 15 = Analog input supervision; 16 = Motor current supervision; 17 = Over heat fault; 18 = Overcurrent regular; 19 = Overvoltage regular; 20 = Undervoltage regular; 21 = 4 mA reference fault/warning; 22 = External fault/warning; 23 = Motor thermal protection; 24 = STO fault output; 25 = Control from I/O; 26 = Remote control; 27 = Un-requested rotation direction; 28 = Fire mode; 29 = Damper control; 30 = Valve control; 31 = Jog speed select; 32 = Fieldbus digital input 1; 33 = Fieldbus digital input 2; 34 = DC charge switch close; 35 = Preheat active; 36 = Cold weather active; 37 = PI Sleep 38 = 2nd stage ramp frequency active; 39 = Prime pump active; 40 = Master drive state; 41 = Slave drive state; or 43 = Single drive control.			
Description:	This parameter allows for setting one of the RO functions to a status word that then can be read over the communication standard status word. This also can be viewed in the keypad monitor value M5.3.			

Table 67. Fieldbus (FB) status (Cont.).

P10.3.8^②	Standard status word Bit 7 function select			ID 2422
Minimum value:	N.A.	Maximum value:	N.A.	Default value: 8
Options:	0 = Not used; 1 = Ready; 2 = Run; 3 = Fault; 4 = Fault invert; 5 = Warning; 6 = Reversed; 7 = At speed; 8 = Zero frequency; 9 = Frequency limit supervision; 10 = PI supervision; 11 = Torque limit supervision; 12 = Reference limit supervision; 13 = Power limit supervision; 14 = Temperature limit supervision; 15 = Analog input supervision; 16 = Motor current supervision; 17 = Over heat fault; 18 = Overcurrent regular; 19 = Overvoltage regular; 20 = Undervoltage regular; 21 = 4 mA reference fault/warning; 22 = External fault/warning; 23 = Motor thermal protection; 24 = STO fault output; 25 = Control from I/O; 26 = Remote control; 27 = Un-requested rotation direction; 28 = Fire mode; 29 = Damper control; 30 = Valve control; 31 = Jog speed select; 32 = Fieldbus digital input 1; 33 = Fieldbus digital input 2; 34 = DC charge switch close; 35 = Preheat active; 36 = Cold weather active; 37 = PI Sleep 38 = 2nd stage ramp frequency active; 39 = Prime pump active; 40 = Master drive state; 41 = Slave drive state; or 43 = Single drive control.			
Description:	This parameter allows for setting one of the RO functions to a status word that then can be read over the communication standard status word. This also can be viewed in the keypad monitor value M5.3.			

^① Parameter value can only be changed after the drive has stopped.

^② Parameter value will be set to be default when changing macros.

Table 68. Serial communication .

P11.1 - Basic settings.				
P11.1.1^①	Serial communication			ID 586
Minimum value:	N.A.	Maximum value:	N.A.	Default value: 0
Options:	0 = Modbus RTU; 1 = BACnet MSTP (*DM1 PRO); or 2 = SWD (*DM1 PRO).			
Description:	This parameter defines the communication protocol for RS-485.			
P11.2 - Modbus RTU.				
P11.2.1^①	Slave address			ID 587
Minimum value:	1	Maximum value:	247	Default value: 1
Description:	This parameter defines the slave address for RS-485 communication.			

Chapter 7- Multi-purpose application

Table 68. Serial communication (Cont.).

P11.2.2^①	Baud rate			ID 584
Minimum value:	N.A.	Maximum value:	N.A.	Default value: 1
Options:	0 = 9,600; 1 = 19,200; 2 = 38,400; 3 = 57,600; or 4 = 115,200			
Description:	This parameter defines communication speed for RS-485 communication.			
P11.2.3^①	Parity type			ID 585
Minimum value:	N.A.	Maximum value:	N.A.	Default value: 2
Options:	0 = None; 1 = Odd; or 2 = Even.			
Description:	This parameter defines parity type for RS-485 communication.			
P11.2.4	Modbus RTU protocol status			ID 588
Minimum value:	N.A.	Maximum value:	N.A.	Default value: N.A.
Options:	0 = Initial; 1 = Stopped; 2 = Operational; or 3 = Faulted.			
Description:	This parameter shows the protocol status for RS-485 communication.			
P11.2.5	Communication timeout modbus RTU			ID 593
Minimum value:	0 ms	Maximum value:	60,000 ms	Default value: 10,000 ms
Description:	Selects the time to wait before a communication fault occurs over modbus RTU if a message is not received.			
P11.2.6	Modbus RTU fault response			ID 2516
Minimum value:	N.A.	Maximum value:	N.A.	Default value: 0
Options:	0 - Only in fieldbus control mode. When fieldbus is the control place and fieldbus fault is active, the drive will fault on loss of communications; if not in fieldbus control, place will not fault. 1 - In all control modes. No matter the control place setting, if communication is lost, fieldbus fault response will occur.			
Description:	Defines the fieldbus fault condition for modbus RTU communication.			
P11.3 - BACnet MSTP.				
P11.3.1^①	MSTP baud rate			ID 594
Minimum value:	N.A.	Maximum value:	N.A.	Default value: 2
Options:	0 = 9,600; 1 = 19,200; 2 = 38,400; 3 = 76,800; or 4 = 115,200.			
Description:	This parameter defines the communication speed for RS-485 communication.			
P11.3.2^①	MSTP device address			ID 595
Minimum value:	0	Maximum value:	127	Default value: 1
Description:	Defines the device address of the drive on the BACnet MSTP network.			
P11.3.3^①	MSTP instance number			ID 596
Minimum value:	0	Maximum value:	4,194,302	Default value: 0
Description:	Defines the instance number of the drive on the BACnet MSTP network.			
P11.3.4	MSTP communication timeout			ID 598
Minimum value:	0 ms	Maximum value:	60,000 ms	Default value: 10,000 ms
Description:	Selects the time to wait before a communication fault occurs over BACnet MSTP if a message is not received.			

Table 68. Serial communication (Cont.).

P11.3.5	MSTP protocol status			ID 599
Minimum value:	N.A.	Maximum value:	N.A.	Default value: N.A.
Options:	0 = Stopped; 1 = Operational; or 2 = Faulted.			
Description:	This parameter shows the protocol status for BACnet MSTP communication.			
P11.3.6	MSTP fault code			ID 600
Minimum value:	N.A.	Maximum value:	N.A.	Default value: N.A.
Options:	0 = None; 1 = Sole master; 2 = Duplicate MAC ID; or 3 = Baud rate fault.			
Description:	This parameter shows the protocol status for BACnet MSTP communication.			
P11.3.7	MSTP fault response			ID 2526
Minimum value:	N.A.	Maximum value:	N.A.	Default value: 0
Options:	0 = Only in fieldbus control mode - when fieldbus is the control place and fieldbus fault is active, the drive will fault on loss of communications. If not in fieldbus control, place will not fault. 1 = In all control modes - no matter the control place setting. If communication is lost, fieldbus fault response will occur.			
Description:	Defines the fieldbus fault condition for BACnet MSTP communication.			
P11.3.8	MSTP maximum master			ID 1537
Minimum value:	1	Maximum value:	127	Default value: 127
Description:	Defines the maximum number of masters that can establish connections with the drive.			
P11.5 - SWD.				
P11.5.1	Parameter access			ID 2630
Minimum value:	N.A.	Maximum value:	N.A.	Default value: 1
Options:	0 = No permission to read/write on acyclic channel; or 1 = Acyclic read/write are allowed on Profibus.			
Description:	PNU927 which specifies the operation priority of parameters for acyclic communication.			
P11.5.2^①	Parameter data access			ID 2631
Minimum value:	N.A.	Maximum value:	N.A.	Default value: 4
Options:	0 = Local control; 1 = Fieldbus; 2 = Mixed interface; 4 = NET, local on fault; or 5 = Dual mode.			
Description:	PNU928 which specifies the control priority of the device for cyclic communication.			
P11.5.3	Fault situation counter			ID 2632
Minimum value:	N.A.	Maximum value:	N.A.	Default value: N.A.
Description:	PNU952 which specifies the fault situation counter. Only write of 0 is allowed, then the whole fault buffer (actual fault situation and all other fault situations) and the fault message counter (parameter 944) are erased.			
P11.5.4	Board status			ID 2609
Minimum value:	N.A.	Maximum value:	N.A.	Default value: 0
Description:	Status of the board: B0-DCOM communication fault; B1-Board HW fault; B2-I01 24 volt overload fault; B3-Profibus communication fault; or B4-fieldbus fault.			

Chapter 7- Multi-purpose application

Table 68. Serial communication (Cont.).

P11.5.5	Firmware version			ID 2610
Minimum value:	N.A.	Maximum value:	N.A.	Default value: N.A.
Description:	This parameter provides the firmware version of the SWD.			
P11.5.6	Protocol status			ID 2612
Minimum value:	N.A.	Maximum value:	N.A.	Default value: 0
Options:	0 = Not configured; 1 = Operational; or 2 = Diagnostics.			
Description:	This parameter specifies the protocol status for SWD card.			
P11.6 - Bluetooth.				
P11.6.1	Bluetooth enabled			ID 1895
Minimum value:	N.A.	Maximum value:	N.A.	Default value: 0
Options:	0 = Disabled; or 1 = Enabled.			
Description:	Bluetooth enabled.			
P11.6.2^②	Bluetooth broadcast mode			ID 2920
Minimum value:	N.A.	Maximum value:	N.A.	Default value: 0
Options:	0 = Off; or 1 = On.			
Description:	Bluetooth broadcast mode.			
P11.6.3	Bluetooth pairing reset			ID 2935
Minimum value:	N.A.	Maximum value:	N.A.	Default value: N.A.
Options:	0 = Not reset; or 1 = Reset.			
Description:	Bluetooth pairing reset.			

① Parameter value can only be changed after the drive has stopped.

② Parameter value will be set to be default when changing macros.

Table 69. Ethernet communication.

P12.1 - Basic settings.				
P12.1.1^①	IP address mode			ID 1500
Minimum value:	N.A.	Maximum value:	N.A.	Default value: 0
Options:	0 = Static IP; or 1 = DHCP with AutoIP.			
Description:	This parameter defined the IP address configuration mode for EIP/modbus TCP.			
P12.1.2	Active IP address			ID 1507
Minimum value:	N.A.	Maximum value:	N.A.	Default value: N.A.
Description:	Reads the current active IP address.			
P12.1.3	Active subnet mask			ID 1509
Minimum value:	N.A.	Maximum value:	N.A.	Default value: N.A.
Description:	Reads the current active subnet mask.			
P12.1.4	Active default gateway			ID 1511
Minimum value:	N.A.	Maximum value:	N.A.	Default value: N.A.
Description:	Reads the current active default gateway.			

Table 69. Ethernet communication (Cont.).

P12.1.5	MAC address			ID 1513
Minimum value:	N.A.	Maximum value:	N.A.	Default value: N.A.
Description:	Reads the current MAC address.			
P12.1.6^①	Static IP address			ID 1501
Minimum value:	N.A.	Maximum value:	N.A.	Default value: 192.168.1.254
Description:	Defines the static IP address.			
P12.1.7^①	Static subnet mask			ID 1503
Minimum value:	N.A.	Maximum value:	N.A.	Default value: 255.255.255.0
Description:	Defines the static subnet mask.			
P12.1.8^①	Static default gateway			ID 1505
Minimum value:	N.A.	Maximum value:	N.A.	Default value: 192.168.1.1
Description:	Defines the static default gateway.			
P12.1.9	Ethernet communication timeout			ID 611
Minimum value:	0 ms	Maximum value:	60,000 ms	Default value: 10,000 ms
Description:	Selects the time it waits before a communication fault occurs over ethernet.			
P12.2 - Trusted IP filter (DM1 PRO only).				
P12.2.1	Trusted IP white list			ID 68
Minimum value:	N.A.	Maximum value:	N.A.	Default value: 0.0.0.0 0.0.0.0 192.168.1.255
Description:	Defines the IP addresses in the white list. A setting of 192.168.1.255 enables all connections on the local subnet.			
P12.2.2	Trusted IP filter enable			ID 76
Minimum value:	N.A.	Maximum value:	N.A.	Default value: 1
Options:	0 = Disabled; or 1 = Enabled.			
Description:	Enables IP white listing. Devices not in the white list will not be able to establish communications with the drive.			
P12.3 - Modbus TCP (DM1 PRO only).				
P12.3.1^①	Modbus TCP enable			ID 1942
Minimum value:	N.A.	Maximum value:	N.A.	Default value: 0
Options:	0 = Disable; or 1 = Enable.			
Description:	Enables modbus TCP communications, must be enabled to connect to Power Xpert inControl.			
P12.3.2	Modbus TCP connection limit			ID 609
Minimum value:	N.A.	Maximum value:	N.A.	Default value: 5
Description:	Maximum number of connections allowed to the drive.			
P12.3.3	Modbus TCP unit identifier number			ID 610
Minimum value:	N.A.	Maximum value:	N.A.	Default value: 1
Description:	Unit identifier unit value for modbus TCP.			
P12.3.4	Modbus TCP protocol status			ID 612
Minimum value:	N.A.	Maximum value:	N.A.	Default value: N.A.
Options:	0 = Stopped; 1 = Operational; or 2 = Faulted.			
Description:	This parameter shows the protocol status for modbus TCP communication.			

Chapter 7- Multi-purpose application

Table 69. Ethernet communication (Cont.).

P12.3.5	Modbus TCP fault response			ID 2517
Minimum value:	N.A.	Maximum value:	N.A.	Default value: 0
Options:	0 = Only in fieldbus control mode - when fieldbus is the control place and fieldbus fault is active, the drive will fault on loss of communications. If not in fieldbus control, place will not fault. 1 = In all control modes - no matter the control place setting, if communication is lost, fieldbus fault response will occur.			
Description:	Defines the fieldbus fault condition for modbus TCP communication.			
P12.4 - Ethernet IP (DM1 PRO only).				
P12.4.1^①	Ethernet based protocol select			ID 1997
Minimum value:	N.A.	Maximum value:	N.A.	Default value: 0
Options:	0 = Disabled; or 2 = BACnet IP.			
Description:	Selects the active communication protocol on the ethernet I/P port.			
P12.4.2	Ethernet IP protocol status			ID 608
Minimum value:	N.A.	Maximum value:	N.A.	Default value: N.A.
Options:	0 = Off; 1 = Operational; or 2 = Faulted.			
Description:	Indicates if ethernet protocol is active or not.			
P12.4.3	Ethernet IP fault response			ID 2518
Minimum value:	N.A.	Maximum value:	N.A.	Default value: 0
Options:	0 = Only in fieldbus control mode - when fieldbus is the control place and Fieldbus fault is active, the drive will fault on loss of communications. If not in fieldbus control, place will not fault. 1 = In all control modes - no matter the control place setting. If communication is lost, fieldbus fault response will occur.			
Description:	Defines the fieldbus fault condition for ethernet IP communication.			
P12.5 - BACnet IP (DM1 PRO only).				
P12.5.1^①	BACnet IP UDP port number			ID 1733
Minimum value:	N.A.	Maximum value:	N.A.	Default value: 47,808
Options:	47808 = BAC0; 47809 = BAC1; 47810 = BAC2; 47811 = BAC3; 47812 = BAC4; 47813 = BAC5; 47814 = BAC6; 47815 = BAC7; 47816 = BAC8; 47817 = BAC9; 47818 = BACA; 47819 = BACB; 47820 = BACC; 47821 = BACD; 47822 = BACE; or 47823 = BACF.			
Description:	Defines the BACnet UDP port number.			
P12.5.2^①	BACnet IP foreign device			ID 1734
Minimum value:	N.A.	Maximum value:	N.A.	Default value: 0
Options:	0 = Disabled; or 1 = Enabled.			
Description:	Enables BACNET IP foreign device configuration.			

Table 69. Ethernet communication (Cont.).

P12.5.3^①	BACnet IP BBMD IP			ID 1735
Minimum value:	N.A.	Maximum value:	N.A.	Default value: 0.0.0.0
Description:	Displays the BACnet BBMD IP address.			
P12.5.4^①	BACnet IP UDP port			ID 1737
Minimum value:	N.A.	Maximum value:	N.A.	Default value: 47,808
Options:	47808 = BAC0; 47809 = BAC1; 47810 = BAC2; 47811 = BAC3; 47812 = BAC4; 47813 = BAC5; 47814 = BAC6; 47815 = BAC7; 47816 = BAC8; 47817 = BAC9; 47818 = BACA; 47819 = BACB; 47820 = BACC; 47821 = BACD; 47822 = BACE; or 47823 = BACF.			
Description:	Displays the BACnet BBMD UDP port number.			
P12.5.5^①	BACnet IP registration interval			ID 1738
Minimum value:	0	Maximum value:	65,535	Default value: 10
Description:	Defines the registration interval.			
P12.5.6	BACnet IP communication timeout			ID 1739
Minimum value:	0 ms	Maximum value:	60,000 ms	Default value: 0 ms
Description:	Selects the time it waits before a communication fault occurs over BACnet IP.			
P12.5.7	BACnet IP protocol status			ID 1740
Minimum value:	N.A.	Maximum value:	N.A.	Default value: 0
Options:	0 = Stopped; 1 = Operational; or 2 = Faulted.			
Description:	This parameter shows the protocol status for BACnet IP communication.			
P12.5.8	BACnet IP fault behavior			ID 1741
Minimum value:	N.A.	Maximum value:	N.A.	Default value: 0
Options:	0 = Only in fieldbus control mode - when fieldbus is the control place and Fieldbus fault is active, the drive will fault on loss of communications. If not in fieldbus control, place will not fault. 1 = In all control modes - no matter the control place setting. If communication is lost, fieldbus fault response will occur.			
Description:	Defines the fieldbus fault condition for BACnet IP communication.			
P12.5.9^①	BACnet IP instance number			ID 1742
Minimum value:	0	Maximum value:	4,194,302	Default value: 0
Description:	Displays the BACnet instance number.			
P12.6 - Web UI (DM1 PRO only).				
P12.6.1	Web UI protocol status			ID 2915
Minimum value:	N.A.	Maximum value:	N.A.	Default value: N.A.
Options:	0 = Off; 1 = Operational; or 2 = Faulted.			
Description:	This parameter shows the protocol status for web server communication.			

Chapter 7- Multi-purpose application

Table 69. Ethernet communication (Cont.).

P12.6.2	Web UI fault response			ID 2916
Minimum value:	N.A.	Maximum value:	N.A.	Default value: 0
Options:	0 = Only in fieldbus control mode - when fieldbus is the control place and fieldbus fault is active, the drive will fault on loss of communications. If not in fieldbus control, place will not fault. 1 = In all control modes - no matter the control place setting. If communication is lost, fieldbus fault response will occur.			
Description:	Defines the fieldbus fault condition for web server communication.			
P12.6.3	Web UI communication timeout			ID 2919
Minimum value:	30,000 ms	Maximum value:	60,000 ms	Default value: 60,000 ms
Description:	Selects the time it waits before a communication fault occurs over the web server.			
P12.6.4^①	Web UI enable			ID 2921
Minimum value:	N.A.	Maximum value:	N.A.	Default value: 0
Options:	0 = Disabled; or 1 = Enabled.			
Description:	Enables web server configuration and monitoring page.			

^① Parameter value can only be changed after the drive has stopped.

^② Parameter value will be set to be default when changing macros.

Table 70. System .

P13.1 - Basic settings.				
P13.1.1	Language			ID 340
Minimum value:	N.A.	Maximum value:	N.A.	Default value: 0
Options:	0 = English; 1 = English; or 2 = English.			
Description:	This parameter offers the ability to control the frequency converter through the keypad in the language of your choice. Currently available language is English only.			
P13.1.2^①	Application			ID 142
Minimum value:	N.A.	Maximum value:	N.A.	Default value: N.A.
Options:	0 = Standard;; 1 = Pump; 2 = Fan; or 3 = Multi-purpose.			
Description:	This parameter sets the active application if multiple applications have been loaded.			
P13.1.3^①	Parameter sets			ID 619
Minimum value:	N.A.	Maximum value:	N.A.	Default value: N.A.
Options:	0 = No; 1 = Load factory default parameters; 2 = Reload set 1; 3 = Reload set 2; 4 = Store parameter set 1; 5 = Store parameter set 2; 6 = Reset; or 7 = Reload defaults VM.			
Description:	This parameter allows you to reload the factory default parameter values, and to store and load two customized parameter sets.			
P13.1.4	Up to keypad			ID 620
Minimum value:	N.A.	Maximum value:	N.A.	Default value: N.A.
Options:	0 = No; or 1 = Yes (all parameters).			
Description:	This function uploads all existing parameter groups to the keypad.			

Table 70. System (Cont.).

P13.1.5[ⓐ]	Down from keypad			ID 621
Minimum value:	N.A.	Maximum value:	N.A.	Default value: N.A.
Options:	0 = No; 1 = All parameters; 2 = All, no motor; or 3 = Application parameters.			
Description:	This function downloads one or all parameter groups from the keypad to the drive.			
P13.1.6	Parameter comparison			ID 623
Minimum value:	N.A.	Maximum value:	N.A.	Default value: N.A.
Options:	0 = No; 1 = Compare with keypad; 2 = Compare with default; 3 = Compare with Set 1; or 4 = Compare with Set 2.			
Description:	<p>With the parameter comparison function, you can compare the actual parameter values to the values of your customized parameter sets and those loaded to the control keypad.</p> <p>The actual parameter values are first compared to those of the customized parameter Set 1. If no differences are detected, a "0" is displayed on the lowermost line of the keypad.</p> <p>If any of the parameter values differ from those of the Set 1 parameters, the number of the deviations is displayed together.</p> <p>By pressing the right arrow button, once again you will see both the actual value and the value it was compared to. In this display, the value on the description line (in the middle) is the default value, and the one on the value line (lowermost line) is the edited value. You can also edit the actual value by pushing the right arrow button.</p> <p>Actual values can also be compared to Set 2, factory settings, and keypad set values.</p>			
P13.1.7	Parameter lock PIN			ID 624
Minimum value:	0	Maximum value:	9,999	Default value: 0
Description:	<p>The application selection can be protected against unauthorized changes with the password function. When the password function is enabled, the user will be prompted to enter a password before application changes, parameter value changes, or password changes.</p> <p>By default, the password function is not in use. If you want to activate the password, change the value of this parameter to any number between 1 and 9,999.</p> <p>To deactivate the password, reset the parameter value to 0.</p>			
P13.1.8	Keypad parameter lock			ID 625
Minimum value:	N.A.	Maximum value:	N.A.	Default value: 0
Options:	0 = Change enable; or 1 = Change disable.			
Description:	<p>This function allows the user to prohibit changes to the parameters. If the parameter lock is activated, the text "locked" will appear on the display if you try to edit a parameter value.</p> <p>Note: This function does not prevent unauthorized editing of parameter values.</p>			
P13.1.9	Start-up Wizard			ID 626
Minimum value:	N.A.	Maximum value:	N.A.	Default value: 0
Options:	0 = Enabled. 1 = Disabled.			
Description:	<p>The Start-up Wizard facilitates commissioning the DM1 PRO. If selected "Enable", the Start-up Wizard prompts the operator for the application desired and then advances parameters through the start-up parameter list/Application Mini wizard in keypad. After completion, it allows the user to go to the main menu or default page and this parameter is set to "Disabled". The Start-up Wizard is always enabled for the initial power up of the DM1 PRO. By setting this parameter to "Disable" without going through the Start-up Wizard, it will not cause it to be active on start-up. If user goes into Start-up Wizard after completion, or defaults drive, the Start-up Wizard will be "Enabled".</p>			

Chapter 7- Multi-purpose application

Table 70. System (Cont.).

P13.2 - Keypad.				
P13.2.1	Local default page			ID 1875
Minimum value:	N.A.	Maximum value:	N.A.	Default value: 0
Options:	0 = None; or 1 = Monitor.			
Description:	Local default page selection.			
P13.2.2	Local monitor parameter set			ID 1876
Minimum value:	N.A.	Maximum value:	N.A.	Default value: 1,1,0
Description:	Local monitor parameter path. Default path is M1.1.			
P13.2.3	Default page			ID 628
Minimum value:	N.A.	Maximum value:	N.A.	Default value: 0
Options:	0 = None; 1 = Main menu; 2 = Multi-monitor; 3 = Favorite menu; or 4 = Keypad reference.			
Description:	This parameter sets the view to which the display automatically moves as the timeout time expires or when the keypad power is switched on. If the default page value is 0, the function is not activated: i.e., the last displayed page remains on the keypad display.			
P13.2.4	Timeout time			ID 629
Minimum value:	1 s	Maximum value:	65,535 s.	Default value: 30 s
Description:	The timeout time setting defines the time after which the keypad display returns to the Default Page. Note: If the default page value is 0, the timeout time setting has no effect.			
P13.2.5	Contrast adjust			ID 630
Minimum value:	5	Maximum value:	18	Default value: 12
Description:	If the remote keypad display is not clear, you can adjust the keypad contrast with this parameter.			
P13.2.6	Backlight time			ID 631
Minimum value:	1 min.	Maximum value:	65,535 min.	Default value: 10 min.
Description:	This parameter determines how long the backlight stays on before going out.			
P13.2.7	Fan control			ID 632
Minimum value:	N.A.	Maximum value:	N.A.	Default value: 1
Options:	0 = Continuous - fan runs continuously. 1 = Temperature - based on the temperature of the unit. The fan is switched on automatically when the heat sink temperature reaches 60°C (140°F). The fan receives a stop command when the heat sink temperature falls to 55°C (131°F). The fan runs for about a minute after receiving the stop command or switching on the power, as well as after changing the value from "Continuous" to "Temperature". 2 = Run follow - after power up, the fan is stopped until the run command is given and then fan runs continuously. This is mainly made for common DC-bus systems to prevent cooling fans to load charging resistors on power up moment.			
Description:	This function allows you to control the DM1 PRO's cooling fan. You can set the fan to run as stated in the options.			
P13.2.8	Keypad ACK timeout			ID 633
Minimum value:	200 ms	Maximum value:	5,000 ms	Default value: 200 ms
Description:	This function allows the user to change the timeout of the keypad acknowledgement time. This is the communication performed between the control module and the keypad. This would be adjusted when using long communication cables between drive and a keypad to delay message timeouts. Example: = Transfer delay between the frequency converter and the PC = 600.00 ms. = The value of HMI acknowledge timeout is set to 1200.00 ms (2 x 600.00, sending delay + receiving delay). = The corresponding setting shall be entered in the [Misc]-part of the file. It must also be considered that intervals shorter than the HMI acknowledge timeout time cannot be used in frequency converter drive monitoring.			

Table 70. System (Cont.).

P13.2.9	Keypad retry number			ID 634
Minimum value:	1	Maximum value:	10	Default value: 5
Description:	With this parameter you can set the number of times the drive will try to receive acknowledgement when it has not been received within the acknowledgement time (HMI acknowledge timeout) or if the received acknowledgement is faulty.			
P13.3 - User display.				
P13.3.1^②	Output display unit			ID 2424
Minimum value:	N.A.	Maximum value:	N.A.	Default value: 45
Options:	0 = %; 1 = 1/min; 2 = rpm; 3 = ppm; 4 = pps; 5 = l/s; 6 = l/min; 7 = l/h; 8 = kg/s; 9 = kg/min; 10 = kg/h; 11 = m ³ /s; 12 = m ³ /min; 13 = m ³ /h; 14 = m/s; 15 = mbar; 16 = bar; 17 = Pa; 18 = kPa; 19 = mV; 20 = kW; 21 = Deg. C; 22 = GPM; 23 = gal/s; 24 = gal/min; 25 = gal/h; 26 = lb/s; 27 = lb/min; 28 = lb/h; 29 = CFM; 30 = ft ³ /s; 31 = ft ³ /min; 32 = ft ³ /h; 33 = ft/s; 34 = in wg; 35 = ft wg; 36 = PSI; 37 = lb/in ² ; 38 = HP; 39 = Deg. F; 40 = PA; 41 = W/C; 42 = HG; 43 = ft; 44 = m; 45 = Hz; 46 = strokes/min.			
Description:	Allows for changing the M1.1 and M1.2 value to a desired unit that will reflect the application. From there with P13.3.2 and P13.3.3, it will allow setting a minimum/maximum limit for the value to display desired output.			
P13.3.2^②	Output display unit minimum			ID 2460
Minimum value:	-60,000.00 varies	Maximum value:	OutputDisplayUnitMax varies	Default value: 0.00 varies
Description:	Sets the minimum scaled value when changing the display unit to a value other than the default Hz.			

Chapter 7- Multi-purpose application

Table 70. System (Cont.).

P13.3.3²	Output display unit maximum			ID 2425
Minimum value:	OutputDisplayUnitMin varies	Maximum value:	60,000.00 varies	Default value: MotorNomFreqMFG varies
Description:	Sets the maximum scaled value when changing the display unit to a value other than the default Hz.			
P13.4 - Version information.				
P13.4.1	Keypad software version			ID 640
Minimum value:	N.A.	Maximum value:	N.A.	Default value: N.A.
Description:	Keypad firmware version.			
P13.4.2	Motor control software version			ID 642
Minimum value:	N.A.	Maximum value:	N.A.	Default value: N.A.
Description:	DSP/motor control software version.			
P13.4.3	Application software version			ID 644
Minimum value:	N.A.	Maximum value:	N.A.	Default value: N.A.
Description:	MCU/application software version.			
P13.4.4	Software bundle version			ID 1714
Minimum value:	N.A.	Maximum value:	N.A.	Default value: N.A.
Description:	Software bundle version.			
P13.5 - Application information.				
P13.5.1	Serial number			ID 648
Minimum value:	N.A.	Maximum value:	N.A.	Default value: N.A.
Description:	Product serial number.			
P13.5.2	Multi-monitor set			ID 627
Minimum value:	N.A.	Maximum value:	N.A.	Default value: 0
Options:	0 = Change enable; or 1 = Change disable.			
Description:	The keypad display can display three actual monitored values at the same time. This parameter determines if the operator is allowed to replace the values monitored with other values.			
P13.5.3	Keypad lock PIN			ID 75
Minimum value:	0	Maximum value:	9,999	Default value: 0
Description:	The keypad can be protected against unauthorized changes with the keypad lock function after keys are not pressed five minutes. When the password function is enabled, the user will be prompted to enter a password before the keypad display parameter or response to key press except up/down/left/right. By default, the password function is not in use. If you want to activate the password, change the value of this parameter to any number between 1 and 9,999. To deactivate the password, reset the parameter value to 0.			
P13.5.4	Drive application name			ID 2922
Minimum value:	N.A.	Maximum value:	N.A.	Default value: N.A.
P13.6 - User information.				
P13.6.1	Total MWh count			ID 601
Minimum value:	N.A. MWh	Maximum value:	N.A. MWh	Default value: N.A. MWh
Description:	Megawatt hours total operation time counter of the drive output active.			

Table 70. System (Cont.).

P13.6.2	Total power day count			ID 603
Minimum value:	N.A.	Maximum value:	N.A.	Default value: N.A.
Description:	Number of days the drive has been supplied with power.			
P13.6.3	Total power hour count			ID 606
Minimum value:	N.A.	Maximum value:	N.A.	Default value: N.A.
Description:	Number of hours the drive has been supplied with power.			
P13.6.4	Total motor hour count			ID 1872
Minimum value:	N.A.	Maximum value:	N.A.	Default value: h
Description:	Number of hours the DM1 PRO has been running a motor.			
P13.6.5	Trip MWh count			ID 604
Minimum value:	N.A.	Maximum value:	N.A.	Default value: MWh
Description:	Megawatts hours of the drive output active since last reset.			
P13.6.6	TClear trip MWh count			ID 639
Minimum value:	N.A.	Maximum value:	N.A.	Default value: 0
Options:	0 = Not reset; 1 = Clear trip MWh count; or 2 = Clear trip power count.			
Description:	Resets the day and hour motor or drive running counter and resets the motor run time in the menu.			
P13.6.7	Trip power day count			ID 636
Minimum value:	N.A.	Maximum value:	N.A.	Default value: N.A.
Description:	Number of days since the last reset.			
P13.6.8	Trip power hour count			ID 637
Minimum value:	N.A.	Maximum value:	N.A.	Default value: N.A.
Description:	Number of hours the DM1 PRO has been running a motor since the last reset.			

① Parameter value can only be changed after the drive has stopped.

② Parameter value will be set to be default when changing macros.

Application notes

Faults and warning codes

Under this menu, you can find active faults, history faults, and fault codes.

Table 71. Active faults.

Menu	Function	Note
Active faults	When a fault/faults appear(s), the display with the name and fault time of the fault will be pop. Press DETAIL to see the fault data.	The fault remains active until it is cleared with the Reset button push for 2s) or with a reset signal from the I/O terminal or fieldbus.
	The active faults submenu shows the list of faults. Select the fault and push DETAIL to see the fault data.	The memory of active faults can store the maximum of 10 faults in the order of appearance.

Table 72. History faults.

Menu	Function	Note
History faults	10 latest faults are stored in the fault history. Select the fault and push DETAIL to see the fault data.	The history fault will be stored until it is cleared with the OK button (push for 5 s).
		The memory of active faults can store the maximum of 10 faults in the order of appearance.

Fault codes and descriptions

Configurable 1 = The fault type of this fault is configurable, fault type can be configured as:

0 = No action; 1 = Warning; 2 = Fault; 3= Fault, Coast.

Fault code	Fault name/description	Fault type	Default configuration	Possible cause	Remedy
1	Over current	Fault		AC drive has detected too high a current (>4*I _H) in the motor cable: <ul style="list-style-type: none"> • Sudden heavy load increase; • Short circuit in motor cables; • Unsuitable motor. 	<ul style="list-style-type: none"> • Check loading. • Check motor. • Check cables and connections. • Make identification run. • Check ramp times.
2	Over voltage	Fault		The DC-link voltage has exceeded the limits defined: <ul style="list-style-type: none"> • Too short a deceleration time; • Brake chopper is disabled; • High overvoltage spikes in supply; • Start/stop sequence too fast. 	<ul style="list-style-type: none"> • Make deceleration time longer. • Use brake chopper or brake resistor (available as options). • Activate overvoltage controller. • Check input voltage.
3	Earth fault	Fault	Configurable	Current measurement has detected that the sum of motor phase current is not zero: <ul style="list-style-type: none"> • Insulation failure in cables or motor. 	<ul style="list-style-type: none"> • Check motor cables and motor.
9	Under voltage	Fault	Configurable	DC link voltage is under the voltage limits defined: <ul style="list-style-type: none"> • Most probable cause: Too low a supply voltage; • AC drive internal fault; • Defect input fuse; • External charge switch not closed. Note: This fault is activated only if the drive is in the Run state.	<ul style="list-style-type: none"> • In case of temporary supply voltage break reset the fault and restart the AC drive. Check the supply voltage. If it is adequate, an internal failure has occurred. Contact the distributor near you.
10	Input phase superv	No action	Configurable	Input line phase is missing.	<ul style="list-style-type: none"> • Check supply voltage, fuses, and cable.
11	Output phase superv	Fault	Configurable	Current measurement has detected that there is no current in one motor phase.	Check motor cable and motor.
13	Drive under temp	Warning	Configurable	Too low temperature measured in power. Unit's heat sink or board. Heat sink temperature is under -10°C.	
14	Drive over temp	Fault		Too high temperature measured in power. Unit's heat sink or board. Heat sink temperature is over 90°C.	<ul style="list-style-type: none"> • Check the correct amount and flow of cooling air. • Check the heat sink for dust. • Check the ambient temperature. • Make sure that the switching frequency is not too high in relation to ambient temperature and motor load.
15	Motor stalled	No action	Configurable	Motor is stalled.	Check motor and load.

Fault code	Fault name/description	Fault type	Default configuration	Possible cause	Remedy
16	Motor over load	No action	Configurable	Motor is too hot, based on either the drive's estimate or on temperature feedback.	Decrease motor load. If no motor overload exists, check the temperature model parameters.
17	Motor under load	No action	Configurable	Condition defined by parameter underload protection, underload F _{nom} torque, underload F ₀ torque, valid longer than the time defined by underload time limit.	Check load.
18	IP address conflict	Warning	Configurable	IP setting issue.	Check settings for IP address. Verify no duplicates are on the network.
19	Power board EEPROM fault	Fault		Power board EEPROM fault, memory lost in EEPROM.	Cycle power to drive. Try updating software. If issue continues, contact distributor near you.
20	Control board EEPROM fault (MCU EEPROM fault)	Fault		EEPROM data error in EEPROM memory.	Cycle power to drive. Try updating software. If issue continues, contact a distributor near you.
21	S-flash fault	Warning		Serial flash error; serial flash memory failed.	Cycle power to drive. Try updating software. If issue continues, contact a distributor near you.
22	Speed deviation	Fault		Estimated speed is greater than 115% of maximum frequency. Or current loop is oscillating.	Check motor parameters and run identification. Adjust the Observer K _p .
23	STO circuit fault	Fault		STO switch is broken; STO circuit failure.	Check STO switch and STO circuit. If issue continues, contact a distributor near you.
25	MCU watchdog fault	Fault		Watchdog register overflows in MCU.	Cycle power to drive. Try updating software. If issue continues, contact a distributor near you.
26	Start-up prevent	Fault		The time when interlock signal activates is over setting time.	Stop drive and resend start command.
37	Device change	Warning		Power board or option card change.	Alarm will reset.
38	Device added	Warning		Power board or option board added.	Device is ready for use. Old parameter settings will be used.
39	Device removed	Fault		Optional board removed from slot; or power board removed from control board.	Device no longer available in drive.
40	Device unknown	Fault		Unknown device connected (power board/option board).	Check EEPROM connection. Check board connection on slot A/B. Power cycle to drive..
41	IGBT over temp	Fault		IGBT temperature is too high.	<ul style="list-style-type: none"> • Check output loading. • Check motor size. • Decrease switching frequency.
50	AI < 4 mA (4 to 20 mA)	No action	Configurable	Loss in analog input signal, dropped below 4 mA.	Verify analog input current reference value on either AI1 or AI2, check cabling.
51	External fault	Fault	Configurable	Digital input is activated for external fault input.	Check digital input settings and verify input level, could be an external device causing fault.
52	Keypad comm. Fault	Fault	Configurable	The connection between the control keypad and frequency converter is broken, and the local reference is keypad reference or the local control place is keypad, and the keypad communication fault protection is not "NO action"	Check keypad connection and possible keypad cable.
54	Option card fault	Fault	Configurable	Defective option card or option card slot.	Check right option card and option card slot connections. Check board status on keypad for exact cause of fault. Contact distributor nearest you.
57	Motor ID fault	Fault		The motor parameters identification running was not completed successfully.	Check motor size. Verify the input and output wiring is connected properly.
58	Current measure fault	Fault		Current measurement is out of range.	Restart the drive again. Should the fault re-occur, contact the distributor nearest to you.
66	Safety torque off	Fault	Configurable	STO triggered; STO input is open.	Reset STO trigger and verify wiring. Reset fault after input is enabled.
67	Current limit control	Warning		The output current has reached the current limit value.	Check the load. Set the acceleration time longer.

Application notes

Fault code	Fault name/description	Fault type	Default configuration	Possible cause	Remedy
68	Over voltage control	Warning		The DC link voltage has reached its voltage limit value.	Check the input voltage. Set the acceleration/deceleration time longer.
70	System fault	Fault		MCU sending wrong parameters to DSP.	Restart the drive again. Should the fault re-occur, contact the distributor nearest to you.
80	Fieldbus fault	Fault	Configurable	BACnet IP fieldbus fault.	Check the fieldbus communication wiring. Verify drive parameters are set correctly. Check BACnet master programming to verify proper addressing.
81	Fieldbus fault	Fault	Configurable	SA bus fieldbus fault.	Check the fieldbus communication wiring on A/B terminal. Verify drive parameters are set correctly. Check SA bus master programming to verify proper addressing.
83	Fieldbus fault	Fault	Configurable	(1) DCI_ubRTUBacNetFaultBehavior parameter's value is 0, loss of communication with modbus RTU, and the fieldbus reference is the remote reference or the fieldbus control place is the remote control place ,and the fault protection is not "NO action"; (2) DCI_ubRTUBacNetFaultBehavior parameter's value is 1, loss of communication with modbus RTU.	Check RS485 communication wiring. Verify drive parameters are set correctly. Check master programming to verify proper addressing.
84	Fieldbus fault	Fault	Configurable	(1) DCI_ubTCPFaultBehavior parameter's value is 0, loss of communication with modbus TCP ,and the fieldbus reference is the remote reference or the fieldbus control place is the remote control place ,and the fault protection is not "NO action"; (2)DCI_ubTCPFaultBehavior parameter's value is 1, loss of communication with modbus TCP.	Check ethernet communication wiring. Verify drive parameter are set correctly. Check master programming to verify proper addressing.
85	Fieldbus fault	Fault	Configurable	Loss of communication with BACnet, and the fieldbus reference is the remote reference OR the fieldbus control place is the remote control place, and the fault protection is not "NO action".	Check RS485 communication wiring. Verify drive parameters are set correctly. Check BACnet master configuration programming to verify proper addressing.
86	Fieldbus fault	Fault	Configurable	Loss of communication with ethernet IP, and the fieldbus reference is the remote reference OR the fieldbus control place is the remote control place, and the fault protection is not "NO action".	Check ethernet communication wiring. Verify drive parameters are set correctly. Check EIP master configuration programming to verify proper addressing.
87	Fieldbus fault	Fault	Configurable	Loss of communication with Profibus/Canopen/Devicenet master on Slot A, and the fieldbus reference is the remote reference OR the fieldbus control place is the remote control place, and the fault protection is not "NO action".	Profibus/Canopen/Devicenet communication wiring. Verify drive parameters are set correctly. Check Profibus/Canopen/Devicenet master configuration programming to verify proper addressing.
90	Drive under temp. (Cold weather drive under temp.)	Warning		<ul style="list-style-type: none"> • Cold weather mode is not enabled, and unit temperature is less than -10°C. • Cold weather mode is enabled and Under Temp Fault Override is not set, unit temperature is less than -30°C. • Cold weather mode is enabled and Under Temp Fault Override is not set, unit temperature is -20 ~ -30°C. The temp <-20°C when cold weather start time out. 	If unit temp -20 ~ -10°C, start motor in cold weather mode. If unit temp <-20°C, warm up unit above -20°C for proper operation using cold weather mode. If still < -20°C when cold weather mode time out, try higher output voltage in cold weather mode.
92	External fault (External fault 2)	Fault	Configurable	Digital input is activated for external fault input.	Check digital input settings and verify input level, could be an external device causing fault.
93	External fault (External fault 3)	Fault	Configurable	Digital input is activated for external fault input.	Check digital input settings and verify input level, could be an external device causing fault.
97	Pipe fill loss (Prime loss)	No action	Configurable	<ul style="list-style-type: none"> • In single drive control mode of MPFC, include FC, interlock enable, and all interlock signals lost. • In single drive control mode of MPFC, not include FC, interlock enable, and interlock 1 lost. • In multi drive network mode of MPFC, interlock enable, and interlock 1 lost. 	Check digital inputs for interlock.
98	PI feedback AI loss	No action	Configurable	The feedback function has a relationship with feedback 1/2 and the feedback 1/2 source has relationship with AI. The AI signal range is 1 (20-100%/2-10 V/4-20m A). The AI value is out of range (AI mode: 0-20 mA, AI < 4 mA or AI > 20 mA, AI mode: 0-10 V, AI < 2 V or AI > 10 V) of PID1 feedback.	Check the AI of PI1 feedback, the AI value whether is out of range or not, the AI range shall be 2-10 V (AI mode is 0-10 V) or 4-20 mA (AI mode is 0-20 mA).

Fault code	Fault name/description	Fault type	Default configuration	Possible cause	Remedy
100	Fieldbus fault (Fieldbus SMDT fault)	Fault	Configurable	Smart wire sus fieldbus fault.	Check SmartWire DT card.
101	Option card fault	Fault	Configurable	SMDT board hardware fault.	Check SmartWire DT card.
102	External fault (External fault from SWD)	Fault	Configurable	External fault from SWD.	Check SmartWire DT card.
103	Drive over temperature	Warning		Drive degree greater than (DCI_wDriveOverTempThreshold value - 10 degree) and less than DCI_wDriveOverTempThreshold value,report drive over temperature warning.	Check the drive degree.
111	Profibus firmware incompatible	Warning		Profibus card firmware is not compatible with MCB firmware.	Check the Profibus card firmware revision.
113	CANOpen firmware incompatible	Warning		CANOpen card firmware is not compatible with MCB firmware.	Check the CANOpen firmware revision.
114	SWD firmware incompatible	Warning		SWD card firmware is not compatible with MCB firmware.	Check the SWD card firmware revision.
115	Fieldbus fault	Fault	Configurable	FieldBus EIP idle fault	Check ethernet IP master programming to verify proper addressing and ensure idle communication bit is not set.
117	Pump over cycle	Warning		During a period, the times which the drive sleeps and wakes up exceed a user configurable value.	Check the reason that drive is not stable. Check why the drive sleeps and wakes up frequently.
118	Broken pipe	Warning	Configurable	PID feedback is less than broken pipe level and the drive output frequency is more than broke pipe frequency for delay time.	
125	Freq. limit supv. (Freq. limit)	No action		The output frequency exceeds the range of frequency supervision limit.	Check the output frequency and check the setting of frequency supervision limit.
126	Torque limit supv. (Torque limit)	No action		The motor torque exceeds the range of torque supervision limit.	Check the motor torque and check the setting of torque supervision limit.
127	Ref. limit supv. (Ref. limit)	No action		The frequency reference exceeds the range of freq. reference supervision limit.	Check the frequency reference and check the setting of frequency reference supervision limit.
128	Power limit supv. (Power limit)	No action		The motor power exceeds the range of power supervision limit.	Check the motor power and check the setting of power supervision limit.
129	Temp. limit supv. (Temp. limit)	No action		The unit temperature exceeds the range of temperature supervision limit.	Check the unit temperature and check the setting of temperature supervision limit.
130	AI limit supv. (AI limit)	No action		The AI value exceeds the range of AI supervision limit.	Check the AI value and check the setting of AI supervision limit.
131	Motor current supv. (Motor current limit)	No action		The motor current exceeds the range of current supervision limit	Check the motor current and check the setting of current supervision limit.
132	PI superv.	No action		The PI1 feedback exceeds the range of PI1 supervision limit.	Check the PI1 feedback and check the setting of PI1 supervision limit.
133	Fieldbus fault (Fieldbus web UI fault)	Fault	Configurable	FieldBus web UI fault.	Check the web connection with RJ45 connector. Verify drive parameters are set correctly. Check the web UI tool to know if there is proper request going to drive or not.

Recommended secure hardening guidelines

Introduction

This section “secure configuration” or “hardening” guidelines provide information to the users to securely deploy and maintain this product to adequately minimize the cybersecurity risks to their system.

Eaton is committed to minimizing the Cybersecurity risk in its products and deploys cybersecurity best practices and latest cybersecurity technologies in its products and solutions; making them more secure, reliable and competitive for our customers. Eaton also offers Cybersecurity Best Practices whitepapers to its customers that can be referenced at www.eaton.com/cybersecurity

PowerXL - secure configuration guidelines

Category	Description
Asset identification and Inventory	<p>Keeping track of all the devices in the system is a pre-requisite for effective management of Cybersecurity of a system. Ensure you maintain an inventory of all the components in your system in a manner in which you uniquely identify each component. To facilitate this PowerXL Series VFD supports the following identifying information - manufacturer, type, serial number, f/w version number, and location.</p> <p>Customers/users can read following information from product label</p> <ul style="list-style-type: none"> • Model Number • Serial Number • Device Name <p>Information specific to communication protocols is available form parameter menu as below</p> <ul style="list-style-type: none"> • IP Address Mode • Active IP Address • MAC Address <p>See application manual for these parameter locations.</p>
Restrict Physical access	<p>Industrial Control Protocols don't offer cryptographic protections at protocol level leaving them exposed to Cybersecurity risk. Physical security is an important layer of defense in such cases. PowerXL Series VFD is designed with the consideration that it would be deployed and operated in a physically secure location.</p> <ul style="list-style-type: none"> • Eaton suggests that physical access to cabinets and/or enclosures containing PowerXL Series VFD and the associated system should be restricted, monitored and logged at all times. • Physical access to the communication lines should be restricted to prevent any attempts of wiretapping, sabotage. It's a best practice to use metal conduits for the communication lines running between one cabinet to another cabinet. • Attacker with unauthorized physical access to the device could cause serious disruption of the device functionality. A combination of physical access controls to the location should be used, such as locks, card readers, and/or guards etc. • PowerXL Series VFD supports the following physical access ports, <ul style="list-style-type: none"> • RJ45 connector for removable keypad as well as Modbus RTU communications • RJ45 for EtherNet IP/Modbus TCP communications • Terminal block for Modbus RTU and other Digital IOs <p>Eaton suggests access to above physical ports need to be restricted.</p>

Category	Description
Restrict logical access to PowerXL series drive	<p>It is extremely important to securely configure the logical access mechanisms provided in PowerXL Series VFD to safeguard the device from unauthorized access. PowerXL Series VFD provides various types of administrative, operational, configuration privilege levels. Eaton recommends that the available access control mechanisms be used properly to ensure that access to the system is restricted to legitimate users only. And, such users are restricted to only the privilege levels necessary to complete their job roles/functions.</p> <p>Eaton recommends below best practices to be followed to ensure adequate cybersecurity of the setup/system</p> <ul style="list-style-type: none"> • Default credentials are changed upon first login. PowerXL Series VFD should not be commissioned for production with Default credentials, it's a serious Cybersecurity flaw as the default credentials are published in the manuals. Restrict administrative privileges - Threat actors are increasingly focused on gaining control of legitimate credentials, especially those associated with highly privileged accounts. Limit privileges to only those needed for a user's duties. Make sure that the password used in the device is only available to authorized users like Configuring Engineers and not shared among all operational users. • Perform periodic account maintenance to make sure that password is changed whenever there is personnel change. • Change passwords and other system access credentials as appropriate • PowerXL Series VFD is provided with data/access protection mechanism on keypad, follow below steps to utilize it <p>PowerXL Series VFD provides four levels of data protection for users to ensure the security:</p> <ol style="list-style-type: none"> 1. Lock parameters on keypad. User can lock the parameters through DI or disable change, in which way all the parameters cannot be edited. 2. Lock parameters while motor running. Motor control parameters can only be modified when motor is in stop mode. In which way to enhance the motor security. The parameters are listed in the application manual. 3. Through Power Xpert inControl tool, facility to hide parameters on keypad is available. User can hide the parameters he/she thinks are significant for himself/herself. Such as IP address and so on. 4. Password on keypad. <ul style="list-style-type: none"> • 0000 means no password, which is the default. • Password range is 0001 ~ 9999. • With password, user can monitor parameters value but need enter password if he/she wants to edit parameters. • User needs to re-enter the password if there is no key operation in 1 min after enter the password. • User needs to enter the old password if he/she wants to change to a new one.
Restrict network access	<p>PowerXL Series VFD provides network access to facilitate communication with other devices in the systems and configuration. But this capability could open up a big security hole if it's not configured securely.</p> <p>Eaton recommends segmentation of networks into logical enclaves and restrict the communication to host-to-host paths. This helps protect sensitive information and critical services and limits damage from network perimeter breaches. At a minimum, a utility Industrial Control Systems network should be segmented into a three-tiered architecture (as recommended by NIST SP800-82[R3]) for better security control.</p> <p>Deploy adequate network protection devices like Firewalls, Intrusion Detection / Protection devices,</p> <p>Below are the protocols and their port details available on PowerXL Series VFD. Use below information for configuring the firewalls.</p> <p>PowerXL Series VFD provides below communication protocols –</p> <ul style="list-style-type: none"> • EtherNet IP protocols on RJ45 connector – enabled by default on port 44818 and 2222 • Modbus TCP protocol on RJ45 connector – enabled by default on port 502 • Modbus RTU on RS485 physical layer – enabled by default • BACnet MS/TP on RS485 physical layer – disabled by default, when this is enabled, Modbus RTU is disabled. <p>All the protocols have dedicated menu structure, and details are described in User's Manual for how to activate or configure them.</p> <ul style="list-style-type: none"> • Eaton has published detailed information about various Network level protection strategies in Eaton Cybersecurity Considerations for Electrical Distribution Systems [R1].

Application notes

Category	Description
Logging and event management	<p>Best practices</p> <ul style="list-style-type: none">• PowerXL Series VFD provides parameters change log and fault log functions for user, to help diagnose the drive <p>1. Parameters change log:</p> <ul style="list-style-type: none">• PowerXL Series VFD will log the parameter information in FRAM when the parameter changes. The max number of 66 items can be logged. New log will rewrite the old one. User cannot clear this fault information. <p>2. Fault log:</p> <ul style="list-style-type: none">• PowerXL Series VFD will log the drive information in FRAM when fault occurs. The max number of 10 items can be logged. New log will rewrite the old one. User can clear the history fault by pressing OK key more than 5 Sec.• PowerXL Series VFD will log the fault information in FRAM when fault occurs. The max number of 50 items can be logged. New log will rewrite the old one. User cannot clear this fault information.
Secure maintenance	<p>Best practices</p> <p>Apply firmware updates and patches regularly</p> <p>Due to rapidly increasing Cyber Threats in Industrial Control Systems, Eaton implements a comprehensive patch and update process for its products. Users are encouraged to maintain a consistent process to promptly monitor for fresh firmware updates and apply the update whenever required.</p> <ul style="list-style-type: none">• The latest firmware can be acquired from the www.eaton.com/drives website. There will be separate link for PowerXL Series VFD FR0 to FR6 and PowerXL Series VFD FR7 & FR8• Users can also sign up on our website to get emails when new material is released to the site if desired.• Using the PC Tool or verifying on the keypad the current version of firmware can be verified.• For additional information or technical support on Eaton's Variable frequency drive products contact us at TRCDrives@eaton.com or by phone at 800-386-2273 for US customers. For European customers contact us at AfterSalesEGBonn@eaton.com or by phone at +49 (0) 228602-3640 <p>Eaton also has a robust vulnerability response process. In the event of any security vulnerability getting discovered in its products, Eaton patches the vulnerability and releases information bulletin through its cybersecurity website - http://www.eaton.com/cybersecurity and patches through www.eaton.com/drives.</p>

References

[R1] Cybersecurity Considerations for Electrical Distribution Systems (WP152002EN):

http://www.eaton.com/ecm/groups/public/@pub/@eaton/@corp/documents/content/pct_1603172.pdf

[R2] Cybersecurity Best Practices Checklist Reminder (WP910003EN):

http://www.cooperindustries.com/content/dam/public/powersystems/resources/library/1100_EAS/WP910003EN.pdf

Notes:

Application notes

Notes:

Notes:



Eaton
1000 Eaton Boulevard
Cleveland, OH 44122
United States
Eaton.com

© 2021 Eaton
All Rights Reserved
Printed in USA
Publication No. MN040049EN/TBG001491
May 2021

Eaton is a registered trademark.

All trademarks are property
of their respective owners.