



# Programming Guide

VLT<sup>®</sup> Automation VT Drive FC 322



## Contents

<b>1 How to Programme</b>	<b>3</b>
How to operate graphical LCP (GLCP)	4
Display Mode	11
Display Mode - Selection of Displayed Variables	11
How to operate numeric LCP (NLCP)	12
Parameter Set-Up	14
<b>2 Parameter Description</b>	<b>21</b>
Main Menu - Operation and Display - Group 0	22
Main Menu - Load and Motor - Group 1	40
Main Menu - Brakes - Group 2	52
Main Menu - Reference/Ramps - Group 3	55
Main Menu - Limits/Warnings - Group 4	65
Main Menu - Digital In/Out - Group 5	72
Main Menu - Analog In/Out - Group 6	99
Main Menu - Communications and Options - Group 8	111
Main Menu - Profibus - Group 9	120
Main Menu - CAN Fieldbus - Group 10	132
Main Menu - Smart Logic - Group 13	140
Main Menu - Special Functions - Group 14	157
Main Menu - Frequency Converter Information - Group 15	166
Main Menu - Data Readouts - Group 16	174
Main Menu - Data Readouts 2 - Group 18	184
Main Menu - FC Closed Loop - Group 20	186
Main Menu - Extended Closed Loop - Group 21	197
Main Menu - Application Functions - Group 22	211
Main Menu - Time-based Functions - Group 23	226
Main Menu - Cascade Controller - Group 25	240
Main Menu - Analog I/O Option MCB 109 - Group 26	254
Main menu – Water application – Group 29	264
Main Menu - Bypass Option - Group 31	266
<b>3 Parameter Lists</b>	<b>267</b>
Parameter Options	267
Default settings	267
Operation/Display 0-**	268
Load/Motor 1-**	270

Brakes 2-**	272
Reference / Ramps 3-**	273
Limits / Warnings 4-**	274
Digital In/Out 5-**	275
Analog In/Out 6-**	276
Comm. and Options 8-**	277
Profibus 9-**	278
CAN Fieldbus 10-**	279
Smart Logic 13-**	280
Special Functions 14-**	281
FC Information 15-**	282
Data Readouts 16-**	284
Data Readouts 2 18-**	286
FC Closed Loop 20-**	287
Ext. Closed Loop 21-**	288
Application Functions 22-**	290
Timed Actions 23-**	292
Cascade Controller 25-**	293
Analog I/O Option MCB 109 26-**	295
Cascade CTL Option 27-**	296
Water Application Functions 29-**	298
Bypass Option 31-**	299

## 1 How to Programme

1

# VLT Automation VT Drive FC 322 Software version: 1.7x



This guide can be used with all FC 322 frequency converters with software version 1.7x or later.  
The actual software version number can be read from par. 15-43 *Software Version*.

# 1

## 1.1.1 How to operate graphical LCP (GLCP)

The following instructions are valid for the GLCP (LCP 102).

### The GLCP is divided into four functional groups:

1. Graphical display with Status lines.
2. Menu keys and indicator lights (LED's) - selecting mode, changing parameters and switching between display functions.
3. Navigation keys and indicator lights (LEDs).
4. Operation keys and indicator lights (LEDs).

### Graphical display:

The LCD-display is back-lit with a total of 6 alpha-numeric lines. All data is displayed on the LCP which can show up to five operating variables while in [Status] mode.

### Display lines:

- a. **Status line:** Status messages displaying icons and graphics.
- b. **Line 1-2:** Operator data lines displaying data and variables defined or chosen by the user. By pressing the [Status] key, up to one extra line can be added.
- c. **Status line:** Status messages displaying text.

The display is divided into 3 sections:

### Top section (a)

shows the status when in status mode or up to 2 variables when not in status mode and in the case of Alarm/Warning.

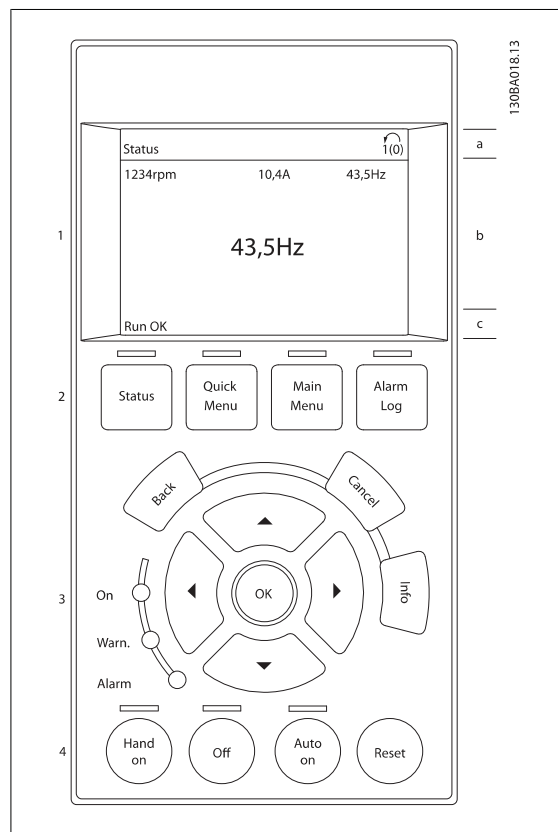

The number of the Active Set-up (selected as the Active Set-up in par. 0-10) is shown. When programming in another Set-up than the Active Set-up, the number of the Set-up being programmed appears to the right in brackets.

### Middle section (b)

shows up to 5 variables with related unit, regardless of status. In case of alarm/warning, the warning is shown instead of the variables.

It is possible to toggle between three status read-out displays by pressing the [Status] key.

Operating variables with different formatting are shown in each status screen - see below.

Several values or measurements can be linked to each of the displayed operating variables. The values / measurements to be displayed can be defined via par. 0-20, 0-21, 0-22, 0-23, and 0-24, which can be accessed via [QUICK MENU], "Q3 Function Setups", "Q3-1 General Settings", "Q3-11 Display Settings".

Each value / measurement readout parameter selected in par. 0-20 to par. 0-24 has its own scale and number of digits after a possible decimal point. Larger numeric values are displayed with few digits after the decimal point.

Ex.: Current readout  
5.25 A; 15.2 A 105 A.

**Status display I**

This read-out state is standard after start-up or initialization. Use [INFO] to obtain information about the value/measurement linked to the displayed operating variables (1.1, 1.2, 1.3, 2, and 3). See the operating variables shown in the display in this illustration. 1.1, 1.2 and 1.3 are shown in small size. 2 and 3 are shown in medium size.

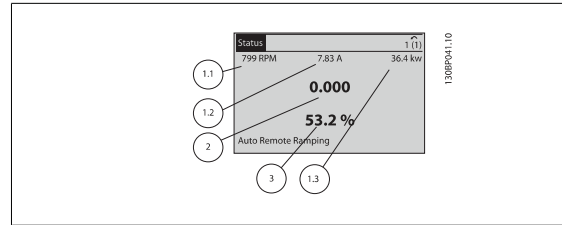

**Status display II**

See the operating variables (1.1, 1.2, 1.3, and 2) shown in the display in this illustration. In the example, Speed, Motor current, Motor power and Frequency are selected as variables in the first and second lines. 1.1, 1.2 and 1.3 are shown in small size. 2 is shown in large size.

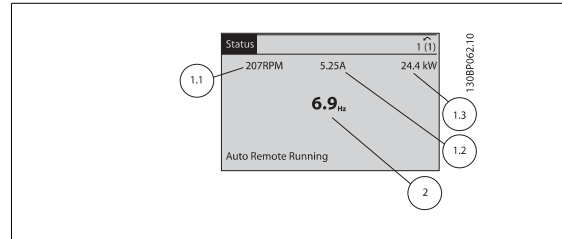

**Status display III:**

This state displays the event and action of the Smart Logic Control. For further information, see section *Smart Logic Control*.

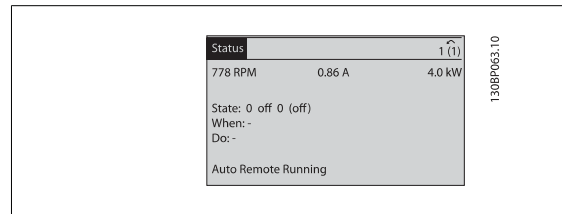

**Bottom section**

always shows the state of the frequency converter in Status mode.

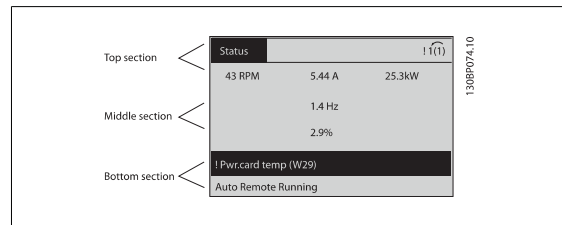

**Display Contrast Adjustment**

Press [status] and [▲] for darker display  
Press [status] and [▼] for brighter display

**Indicator lights (LEDs):**

If certain threshold values are exceeded, the alarm and/or warning LED lights up. A status and alarm text appear on the control panel. The On LED is activated when the frequency converter receives power from mains voltage, a DC bus terminal, or an external 24 V supply. At the same time, the back light is on.

- Green LED/On: Control section is working.
- Yellow LED/Warn.: Indicates a warning.
- Flashing Red LED/Alarm: Indicates an alarm.

**1**

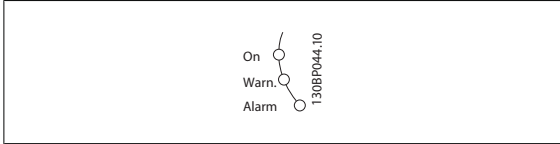

### GLCP keys

#### Menu keys

The menu keys are divided into functions. The keys below the display and indicator lamps are used for parameter set-up, including choice of display indication during normal operation.

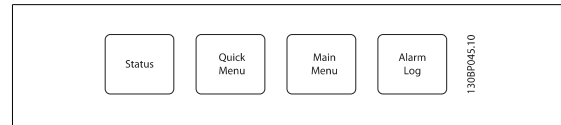

#### [Status]

Indicates the status of the frequency converter and/or the motor. 3 different readouts can be chosen by pressing the [Status] key:

5 line readouts, 4 line readouts or Smart Logic Control.

Use [Status] for selecting the mode of display or for changing back to Display mode from either the Quick Menu mode, the Main Menu mode or Alarm mode. Also use the [Status] key to toggle single or double read-out mode.

#### [Quick Menu]

Allows quick set-up of the frequency converter. **The most common functions can be programmed here.**

##### The [Quick Menu] consists of:

- **Q1: My Personal Menu**
- **Q2: Quick Setup**
- **Q3: Function Setups**
- **Q5: Changes Made**
- **Q6: Loggings**

The Function set-up provides quick and easy access to all parameters required for the majority of water and wastewater applications including variable torque, constant torque, pumps, dosing pumps, well pumps, booster pumps, mixer pumps, aeration blowers and other pump and fan applications. Amongst other features it also includes parameters for selecting which variables to display on the LCP, digital preset speeds, scaling of analog references, closed loop single zone and multi-zone applications and specific functions related to water and wastewater applications.

The Quick Menu parameters can be accessed immediately unless a password has been created via par. 0-60, 0-61, 0-65 or 0-66.

It is possible to switch directly between Quick Menu mode and Main Menu mode.

#### [Main Menu]

is used for programming all parameters.

The Main Menu parameters can be accessed immediately unless a password has been created via par. 0-60, 0-61, 0-65 or 0-66. For the majority of water and wastewater applications it is not necessary to access the Main Menu parameters but instead the Quick Menu, Quick Setup and Function Setups provides the simplest and quickest access to the typical required parameters.

It is possible to switch directly between Main Menu mode and Quick Menu mode.

Parameter shortcut can be carried out by pressing down the [Main Menu] key for 3 seconds. The parameter shortcut allows direct access to any parameter.

#### [Alarm Log]

displays an Alarm list of the five latest alarms (numbered A1-A5). To obtain additional details about an alarm, use the arrow keys to manoeuvre to the alarm number and press [OK]. Information is displayed about the condition of the frequency converter before it enters the alarm mode.

#### [Back]

reverts to the previous step or layer in the navigation structure.

#### [Cancel]

last change or command will be cancelled as long as the display has not been changed.

#### [Info]

displays information about a command, parameter, or function in any display window. [Info] provides detailed information when needed.

Exit Info mode by pressing either [Info], [Back], or [Cancel].

**1**



**1**

**Navigation Keys**

The four navigation arrows are used to navigate between the different choices available in **[Quick Menu]**, **[Main Menu]** and **[Alarm Log]**. Use the keys to move the cursor.

**[OK]**

is used for choosing a parameter marked by the cursor and for enabling the change of a parameter.

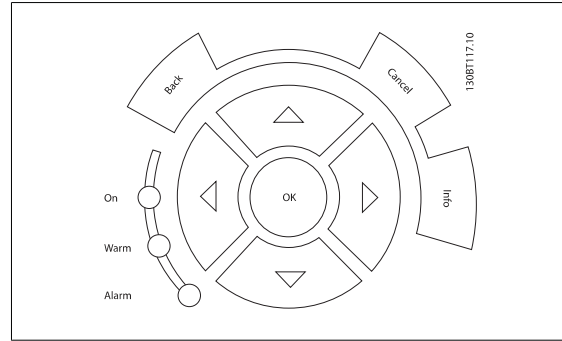

**Operation Keys**

for local control are found at the bottom of the control panel.

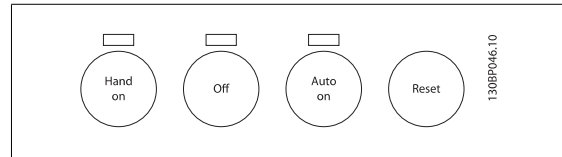

**[Hand On]**

enables control of the frequency converter via the GLCP. [Hand on] also starts the motor, and it is now possible to give the motor speed reference by means of the arrow keys. The key can be *Enabled* [1] or *Disabled* [0] via par. 0-40 [Hand on] Key on LCP.

**The following control signals will still be active when [Hand on] is activated:**

- [Hand on] - [Off] - [Auto on]
- Reset
- Coasting stop inverse (motor coasting to stop)
- Reversing
- Set-up select lsb - Set-up select msb
- Stop command from serial communication
- Quick stop
- DC brake

**NB!**  
External stop signals activated by means of control signals or a serial bus will override a "start" command via the LCP.

**[Off]**

stops the connected motor. The key can be *Enabled* [1] or *Disabled* [0] via par. 0-41 [Off] key on LCP. If no external stop function is selected and the [Off] key is inactive the motor can only be stopped by disconnecting the mains supply.

**[Auto On]**

enables the frequency converter to be controlled via the control terminals and/or serial communication. When a start signal is applied on the control terminals and/or the bus, the frequency converter will start. The key can be *Enabled* [1] or *Disabled* [0] via par. 0-42 [Auto on] key on LCP.

**NB!**  
An active HAND-OFF-AUTO signal via the digital inputs has higher priority than the control keys [Hand on] – [Auto on].

**[Reset]**

is used for resetting the frequency converter after an alarm (trip). The key can be *Enabled* [1] or *Disabled* [0] via par. 0-43 Reset Keys on LCP.

# 1

## The parameter shortcut

can be carried out by holding down the [Main Menu] key for 3 seconds. The parameter shortcut allows direct access to any parameter.

### 1.1.2 Quick Transfer of Parameter Settings between Multiple Frequency Converters

Once the set-up of a frequency converter is complete, we recommend that you store the data in the LCP or on a PC via MCT 10 Set-up Software Tool.

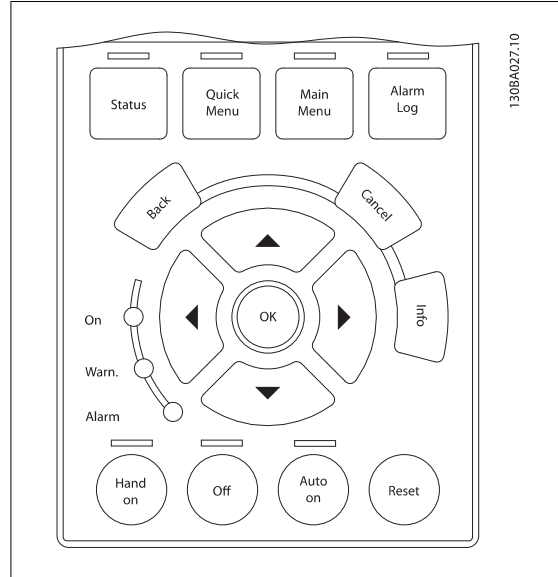

#### Data storage in LCP:

1. Go to par. 0-50 *LCP Copy*
2. Press the [OK] key
3. Select "All to LCP"
4. Press the [OK] key

All parameter settings are now stored in the LCP indicated by the progress bar. When 100% is reached, press [OK].



#### NB!

Stop the motor before performing this operation.

You can now connect the LCP to another frequency converter and copy the parameter settings to this frequency converter as well.

#### Data transfer from LCP to frequency converter:

1. Go to par. 0-50 *LCP Copy*
2. Press the [OK] key
3. Select "All from LCP"
4. Press the [OK] key

The parameter settings stored in the LCP are now transferred to the frequency converter indicated by the progress bar. When 100% is reached, press [OK].



**NB!**  
Stop the motor before performing this operation.

**1**

### 1.1.3 Display Mode

In normal operation, up to 5 different operating variables can be indicated continuously in the middle section: 1.1, 1.2, and 1.3 as well as 2 and 3.

### 1.1.4 Display Mode - Selection of Displayed Variables

It is possible to toggle between three status read-out screens by pressing the [Status] key. Operating variables with different formatting are shown in each status screen - see below.

Several measurements can be linked to each of the operating variables. Define the links via par. 0-20, 0-21, 0-22, 0-23, and 0-24.

Each readout parameter selected in par. 0-20 to par. 0-24 has its own scale and digits after a possible decimal point. By larger numeric value of a parameter fewer digits are displayed after the decimal point.

Ex.: Current readout below: 5.25 A; 15.2 A 105 A.

#### Status screen I

This read-out state is standard after start-up or initialization. Use [INFO] to obtain information about the measurement links to the displayed operating variables (1.1, 1.2, 1.3, 2, and 3). See the operating variables shown in the screen in this illustration. 1.1, 1.2 and 1.3 are shown in small size. 2 and 3 are shown in medium size.

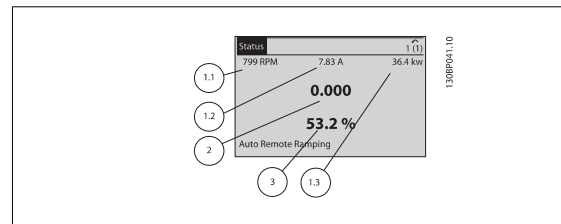

#### Status screen II:

See the operating variables (1.1, 1.2, 1.3, and 2) shown in the screen in this illustration. In the example, Speed, Motor current, Motor power and Frequency are selected as variables in the first and second. 1.1, 1.2 and 1.3 are shown in small size. 2 is shown in large size.

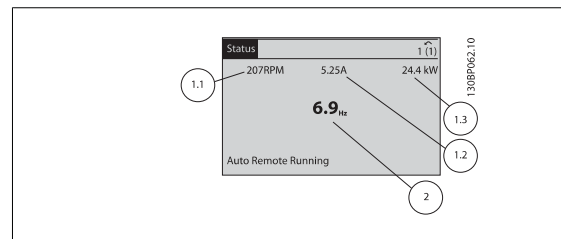

In both status screen I and II it is possible to select other operating variables by pressing ▲ or ▼ .

#### Status screen III:

This state displays the event and action of the Smart Logic Control. For further information, see section *Smart Logic Control*.

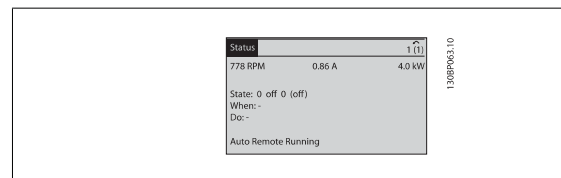

**1**

**1.1.5 How to operate numeric LCP (NLCP)**

The following instructions are valid for the NLCP (LCP 101).

**The control panel is divided into four functional groups:**

1. Numeric display.
2. Menu key and indicator lights (LEDs) - changing parameters and switching between display functions.
3. Navigation keys and indicator lights (LEDs).
4. Operation keys and indicator lights (LEDs).

**NB!**  
Parameter copy is not possible with Numeric Local Control Panel (LCP101).

**Select one of the following modes:**

**Status Mode:** Displays the status of the frequency converter or the motor.

If an alarm occurs, the NLCP automatically switches to status mode. A number of alarms can be displayed.

**Quick Setup or Main Menu Mode:** Display parameters and parameter settings.

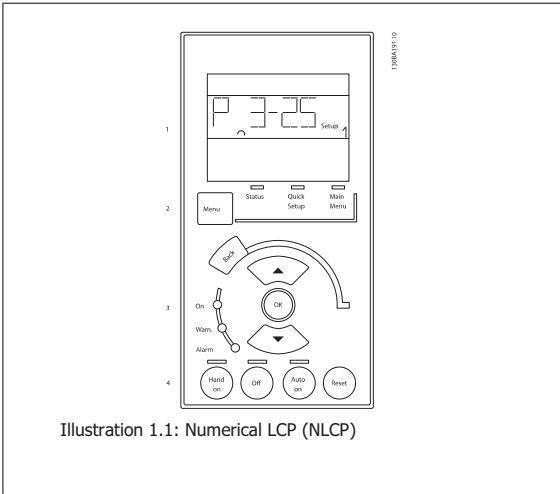

Illustration 1.1: Numerical LCP (NLCP)

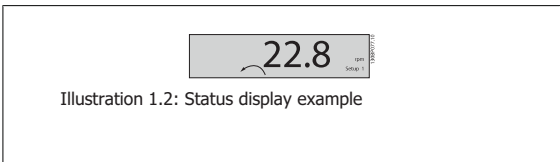

Illustration 1.2: Status display example

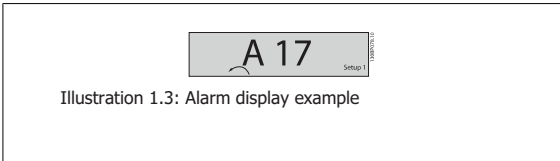

Illustration 1.3: Alarm display example

**Indicator lights (LEDs):**

- Green LED/On: Indicates if control section is on.
- Yellow LED/Wrn.: Indicates a warning.
- Flashing red LED/Alarm: Indicates an alarm.

**Menu key**

**[Menu] Select one of the following modes:**

- Status
- Quick Setup
- Main Menu

**Main Menu**

is used for programming all parameters.

The parameters can be accessed immediately unless a password has been created via par. 0-60 *Main Menu Password*, par. 0-61 *Access to Main Menu w/o Password*, par. 0-65 *Personal Menu Password* or par. 0-66 *Access to Personal Menu w/o Password*.

**Quick Setup** is used to set up the frequency converter using only the most essential parameters.

The parameter values can be changed using the up/down arrows when the value is flashing.

Select Main Menu by pressing the [Menu] key a number of times until the Main Menu LED is lit.

Select the parameter group [xx-\_\_] and press [OK]

Select the parameter [\_\_-xx] and press [OK]

If the parameter is an array parameter select the array number and press [OK]

Select the wanted data value and press [OK]

**Navigation Keys**

**[Back]**

for stepping backwards

**Arrow [▲] [▼]**

keys are used for manoeuvring between parameter groups, parameters and within parameters

**[OK]**

is used for choosing a parameter marked by the cursor and for enabling the change of a parameter.

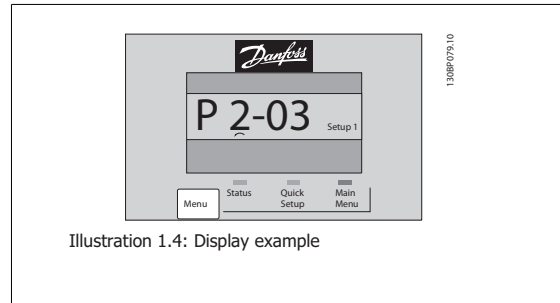

Illustration 1.4: Display example

**Operation Keys**

Keys for local control are found at the bottom of the control panel.

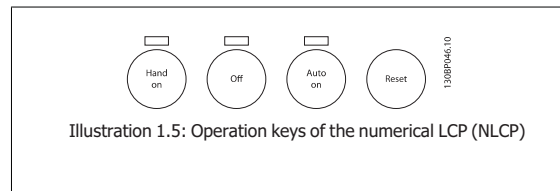

Illustration 1.5: Operation keys of the numerical LCP (NLCP)

**[Hand on]**

enables control of the frequency converter via the LCP. [Hand on] also starts the motor and it is now possible to enter the motor speed data by means of the arrow keys. The key can be *Enabled* [1] or *Disabled* [0] via par. 0-40 *[Hand on] Key on LCP*.

External stop signals activated by means of control signals or a serial bus will override a 'start' command via the LCP.

**The following control signals will still be active when [Hand on] is activated:**

- [Hand on] - [Off] - [Auto on]
- Reset
- Coasting stop inverse
- Reversing
- Set-up select lsb - Set-up select msb
- Stop command from serial communication
- Quick stop
- DC brake

**[Off]**

stops the connected motor. The key can be *Enabled* [1] or *Disabled* [0] via par. 0-41 *[Off] Key on LCP*.

If no external stop function is selected and the [Off] key is inactive the motor can be stopped by disconnecting the mains supply.

**[Auto on]**

enables the frequency converter to be controlled via the control terminals and/or serial communication. When a start signal is applied on the control terminals and/or the bus, the frequency converter will start. The key can be *Enabled* [1] or *Disabled* [0] via par. 0-42 *[Auto on] Key on LCP*.

**1**

**NB!**  
An active HAND-OFF-AUTO signal via the digital inputs has higher priority than the control keys [Hand on] [Auto on].

**[Reset]**

is used for resetting the frequency converter after an alarm (trip). The key can be *Enabled* [1] or *Disabled* [0] via par. 0-43 *[Reset] Key on LCP*.

**1.1.6 Parameter Set-Up**

The frequency converter can be used for practically all assignments, thus offering a significant number of parameters. The series offers a choice between two programming modes - a Quick Menu mode and a Main Menu mode.

The latter provides access to all parameters. The former takes the user through a few parameters making it possible to **program the majority of water/ wastewater applications**.

Regardless of the mode of programming, you can change a parameter both in the Quick Menu mode and in the Main Menu mode.

**1.1.7 Quick Menu Mode**

The GLCP provides access to all parameters listed under the Quick Menus. To set parameters using the [Quick Menu] button:

Pressing [Quick Menu] the list indicates the different areas contained in the Quick menu.

**Efficient Parameter Set-up for Water Applications**

The parameters can easily be set up for the vast majority of the water and wastewater applications only by using the **[Quick Menu]**.

**The optimum way to set parameters through the [Quick Menu] is by following the below steps:**

1. Press [Quick Setup] for selecting basic motor settings, ramp times, etc.
2. Press [Function Setups] for setting up the required functionality of the frequency converter - if not already covered by the settings in [Quick Setup].
3. Choose between *General Settings*, *Open Loop Settings* and *Closed Loop Settings*.

It is recommended to do the set-up in the order listed.

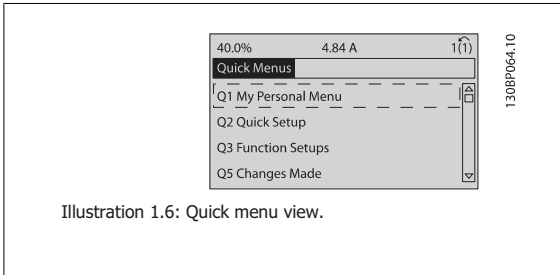

Illustration 1.6: Quick menu view.

Par.	Designation	[Units]
0-01	Language	
1-20	Motor Power	[kW]
1-22	Motor Voltage	[V]
1-23	Motor Frequency	[Hz]
1-24	Motor Current	[A]
1-25	Motor Nominal Speed	[RPM]
3-41	Ramp 1 Ramp up Time	[s]
3-42	Ramp 1 Ramp down Time	[s]
4-11	Motor Speed Low Limit	[RPM]
4-13	Motor Speed High Limit	[RPM]
1-29	Automatic Motor Adaptation (AMA)	

Table 1.1: Quick Setup parameters

If *No Operation* is selected in terminal 27 no connection to +24 V on terminal 27 is necessary to enable start.

If *Coast Inverse* (factory default value) is selected in Terminal 27, a connection to +24V is necessary to enable start.

**NB!**

For detailed parameter descriptions, please see the following section on *Commonly Used Parameters - Explanations*.

### 1.1.8 Q3 Function Setups

The Function Setup provides quick and easy access to all parameters required for the majority of water and wastewater applications including variable torque, constant torque, pumps, dosing pumps, well pumps, booster pumps, mixer pumps, aeration blowers and other pump and fan applications. Amongst other features it also includes parameters for selecting which variables to display on the LCP, digital preset speeds, scaling of analog references, closed loop single zone and multi-zone applications and specific functions related to water and wastewater applications.

**How to access Function Set-up - example:**

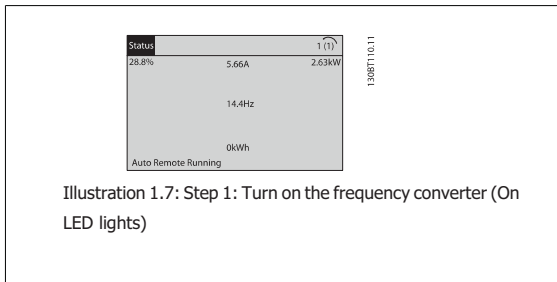

Illustration 1.7: Step 1: Turn on the frequency converter (On LED lights)

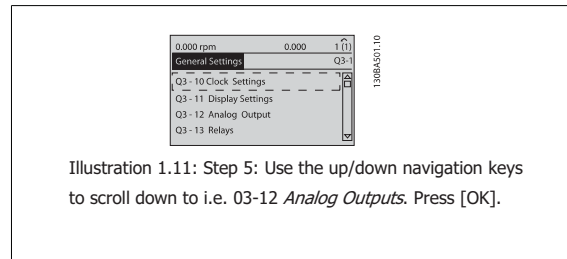

Illustration 1.11: Step 5: Use the up/down navigation keys to scroll to i.e. Q3-12 *Analog Outputs*. Press [OK].

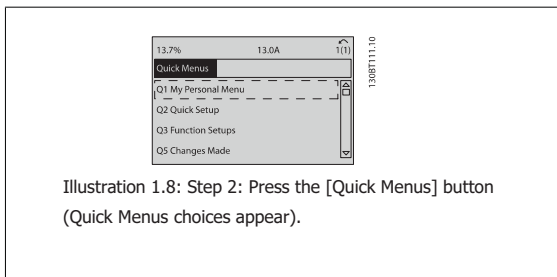

Illustration 1.8: Step 2: Press the [Quick Menus] button (Quick Menu choices appear).

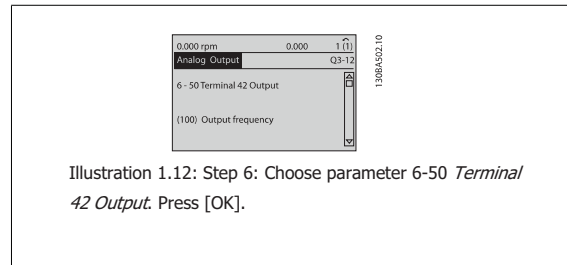

Illustration 1.12: Step 6: Choose parameter 6-50 *Terminal 42 Output*. Press [OK].

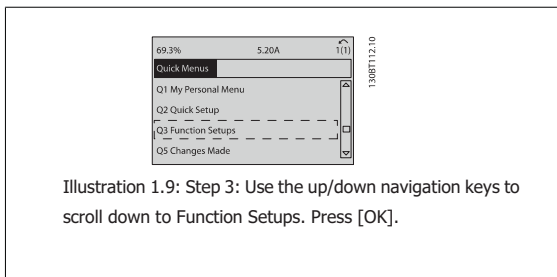

Illustration 1.9: Step 3: Use the up/down navigation keys to scroll down to Function Setups. Press [OK].

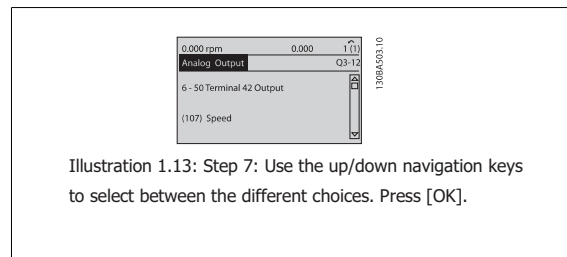

Illustration 1.13: Step 7: Use the up/down navigation keys to select between the different choices. Press [OK].

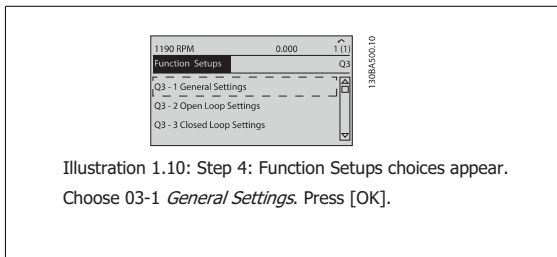

Illustration 1.10: Step 4: Function Setups choices appear. Choose Q3-1 *General Settings*. Press [OK].

The Function Setup parameters are grouped in the following way:

**1**

Q3-1 General Settings			
Q3-10 Clock Settings	Q3-11 Display Settings	Q3-12 Analog Output	Q3-13 Relays
0-70 Set Date and Time	0-20 Display Line 1.1 Small	6-50 Terminal 42 Output	Relay 1 → 5-40 Function Relay
0-71 Date Format	0-21 Display Line 1.2 Small	6-51 Terminal 42 Output Min Scale	Relay 2 → 5-40 Function Relay
0-72 Time Format	0-22 Display Line 1.3 Small	6-52 Terminal 42 Output Max Scale	Option relay 7 → 5-40 Function Relay
0-74 DST/Summertime	0-23 Display Line 2 Large		Option relay 8 → 5-40 Function Relay
0-76 DST/Summertime Start	0-24 Display Line 3 Large		Option relay 9 → 5-40 Function Relay
0-77 DST/Summertime End	0-37 Display Text 1		
	0-38 Display Text 2		
	0-39 Display Text 3		

Q3-2 Open Loop Settings	
Q3-20 Digital Reference	Q3-21 Analog Reference
3-02 Minimum Reference	3-02 Minimum Reference
3-03 Maximum Reference	3-03 Maximum Reference
3-10 Preset Reference	6-10 Terminal 53 Low Voltage
5-13 Terminal 29 Digital Input	6-11 Terminal 53 High Voltage
5-14 Terminal 32 Digital Input	6-14 Terminal 53 Low Ref/Feedb. Value
5-15 Terminal 33 Digital Input	6-15 Terminal 53 High Ref/Feedb. Value

Q3-3 Closed Loop Settings	
Q3-30 Feedback Settings	Q3-31 PID Settings
1-00 Configuration Mode	20-81 PID Normal/Inverse Control
20-12 Reference/Feedb.Unit	20-82 PID Start Speed [RPM]
3-02 Minimum Reference	20-21 Setpoint 1
3-03 Maximum Reference	20-93 PID Proportional Gain
6-20 Terminal 54 Low Voltage	20-94 PID Integral Time
6-21 Terminal 54 High Voltage	
6-24 Terminal 54 Low Ref/Feedb Value	
6-25 Terminal 54 High Ref/Feedb Value	
6-00 Live Zero Timeout Time	
6-01 Live Zero Timeout Function	

### 1.1.9 Main Menu Mode

Both the GLCP and NLCP provide access to the main menu mode. Select the Main Menu mode by pressing the [Main Menu] key. Illustration 6.2 shows the resulting read-out, which appears on the display of the GLCP. Lines 2 through 5 on the display show a list of parameter groups which can be chosen by toggling the up and down buttons.

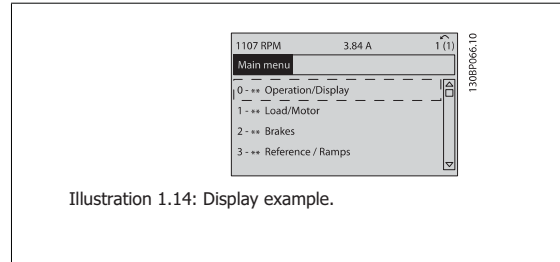

Illustration 1.14: Display example.

Each parameter has a name and number which remain the same regardless of the programming mode. In the Main Menu mode, the parameters are divided into groups. The first digit of the parameter number (from the left) indicates the parameter group number.

All parameters can be changed in the Main Menu. The configuration of the unit (par. 1-00 *Configuration Mode*) will determine other parameters available for programming. For example, selecting Closed Loop enables additional parameters related to closed loop operation. Option cards added to the unit enable additional parameters associated with the option device.

### 1.1.10 Parameter Selection

In the Main Menu mode, the parameters are divided into groups. Select a parameter group by means of the navigation keys. The following parameter groups are accessible:

Group no.	Parameter group:
0	Operation/Display
1	Load/Motor
2	Brakes
3	References/Ramps
4	Limits/Warnings
5	Digital In/Out
6	Analog In/Out
8	Comm. and Options
9	Profibus
10	CAN Fieldbus
11	LonWorks
13	Smart Logic
14	Special Functions
15	Drive Information
16	Data Readouts
18	Data Readouts 2
20	Drive Closed Loop
21	Ext. Closed Loop
22	Application Functions
23	Time-based Functions
24	Fire Mode
25	Cascade Controller
26	Analog I/O Option MCB 109

Table 1.2: Parameter groups.

After selecting a parameter group, choose a parameter by means of the navigation keys.

The middle section on the GLCP display shows the parameter number and name as well as the selected parameter value.

**1**

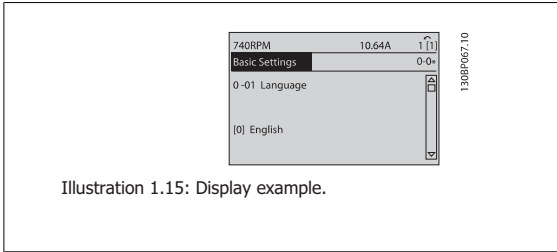

Illustration 1.15: Display example.

**1.1.11 Changing Data**

The procedure for changing data is the same whether you select a parameter in the Quick menu or the Main menu mode. Press [OK] to change the selected parameter.

The procedure for changing data depends on whether the selected parameter represents a numerical data value or a text value.

**1.1.12 Changing a Text Value**

If the selected parameter is a text value, change the text value by means of the up/down navigation keys.

The up key increases the value, and the down key decreases the value.

Place the cursor on the value to be saved and press [OK].

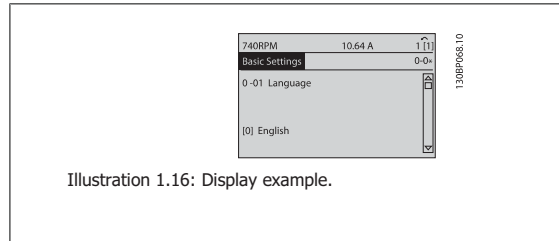

Illustration 1.16: Display example.

**1.1.13 Changing a Group of Numeric Data Values**

If the chosen parameter represents a numeric data value, change the chosen data value by means of the [←] and [→] navigation keys as well as the up/down [▲] [▼] navigation keys. Use the [←] and [→] navigation keys to move the cursor horizontally.

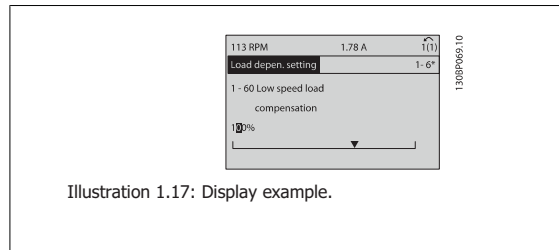

Illustration 1.17: Display example.

Use the up/down navigation keys to change the data value. The up key enlarges the data value, and the down key reduces the data value. Place the cursor on the value to be saved and press [OK].

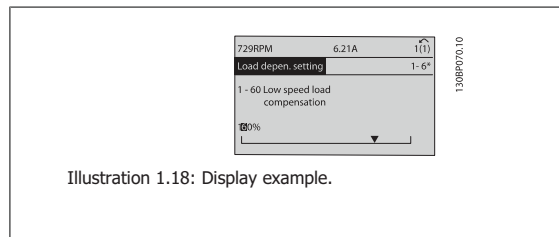

Illustration 1.18: Display example.

### 1.1.14 Changing of Data Value, Step-by-Step

Certain parameters can be changed step by step or infinitely variably. This applies to par. 1-20 *Motor Power [kW]*, par. 1-22 *Motor Voltage* and par. 1-23 *Motor Frequency*.

The parameters are changed both as a group of numeric data values and as numeric data values infinitely variably.

1

### 1.1.15 Read-out and Programming of Indexed Parameters

Parameters are indexed when placed in a rolling stack.

par. 15-30 *Alarm Log: Error Code* to par. 15-32 *Alarm Log: Time* contain a fault log which can be read out. Choose a parameter, press [OK], and use the up/down navigation keys to scroll through the value log.

Use par. 3-10 *Preset Reference* as another example:

Choose the parameter, press [OK], and use the up/down navigation keys to scroll through the indexed values. To change the parameter value, select the indexed value and press [OK]. Change the value by using the up/down keys. Press [OK] to accept the new setting. Press [Cancel] to abort. Press [Back] to leave the parameter.

## 1

**1.1.16 Initialisation to Default Settings**

Initialise the frequency converter to default settings in two ways:

**Recommended initialisation (via par. 14-22 Operation Mode)**

1. Select par. 14-22 *Operation Mode*
2. Press [OK]
3. Select "Initialisation"
4. Press [OK]
5. Cut off the mains supply and wait until the display turns off.
6. Reconnect the mains supply - the frequency converter is now reset.
7. Change par. 14-22 *Operation Mode* back to *Normal Operation*.

**NB!**

Resets parameters selected in Personal Menu with default factory setting.

par. 14-22 *Operation Mode* initialises all except:

par. 14-50 *RFI Filter*

par. 8-30 *Protocol*

par. 8-31 *Address*

par. 8-32 *Baud Rate*

par. 8-35 *Minimum Response Delay*

par. 8-36 *Max Response Delay*

par. 8-37 *Maximum Inter-Char Delay*

par. 15-00 *Operating Hours* to par. 15-05 *Over Volt's*

par. 15-20 *Historic Log: Event* to par. 15-22 *Historic Log: Time*

par. 15-30 *Alarm Log: Error Code* to par. 15-32 *Alarm Log: Time*

**Manual initialisation**

1. Disconnect from mains and wait until the display turns off.
  - 2a. Press [Status] - [Main Menu] - [OK] at the same time while power up for LCP 102, Graphical Display
  - 2b. Press [Menu] while power up for LCP 101, Numerical Display
  3. Release the keys after 5 s.
  4. The frequency converter is now programmed according to default settings.
- This procedure initializes all except: par. 15-00 *Operating Hours*; par. 15-03 *Power Up's*; par. 15-04 *Over Temp's*; par. 15-05 *Over Volt's*.

**NB!**

When you carry out manual initialisation, you also reset serial communication, par. 14-50 *RFI Filter* and fault log settings.  
Removes parameters selected in par. 25-00 *Cascade Controller*.

**NB!**

After initialization and power cycling, the display will not show any information until after a couple of minutes.

## 2 Parameter Description

### 2.1.1 Parameter Set-Up

2

#### Overview of parameter groups

Group	Title	Function
0-	Operation / Display	Parameters related to the fundamental functions of the frequency converter, function of the LCP buttons and configuration of the LCP display.
1-	Load / Motor	Parameter group for motor settings.
2-	Brakes	Parameter group for setting brake features in the frequency converter.
3-	Reference / Ramps	Parameters for reference handling, definitions of limitations, and configuration of the reaction of the frequency converter to changes.
4-	Limits / Warnings	Parameter group for configuring limits and warnings.
5-	Digital In/Out	Parameter group for configuring the digital inputs and outputs.
6-	Analog In/Out	Parameter group for configuration of the analog inputs and outputs.
8-	Communication and Options	Parameter group for configuring communications and options.
9-	Profibus	Parameter group for Profibus-specific parameters.
10-	DeviceNet Fieldbus	Parameter group for DeviceNet-specific parameters.
13-	Smart Logic	Parameter group for Smart Logic Control
14-	Special Functions	Parameter group for configuring special frequency converter functions.
15-	Drive Information	Parameter group containing frequency converter information such as operating data, hardware configuration and software versions.
16-	Data Readouts	Parameter group for data read-outs, e.g. actual references, voltages, control, alarm, warning and status words.
18-	Info and Readouts	This parameter group contains the last 10 Preventive Maintenance logs.
20-	Drive Closed Loop	This parameter group is used for configuring the closed loop PID Controller that controls the output frequency of the unit.
21-	Extended Closed Loop	Parameters for configuring the three Extended Closed Loop PID Controllers.
22-	Application Functions	These parameters monitor water applications.
23-	Time-based Functions	These parameters are for actions needed to be performed on a daily or weekly basis, e.g. different references for working hours/non-working hours.
25-	Basic Cascade Controller Functions	Parameters for configuring the Basic Cascade Controller for sequence control of multiple pumps.
26-	Analog I/O Option MCB 109	Parameters for configuring the Analog I/O Option MCB 109.
27-	Extended Cascade Control	Parameters for configuring the Extended Cascade Control.
29-	Water Application Functions	Parameters for setting water specific functions.
31-	Bypass Option	Parameters for configuring the Bypass Option

Table 2.1: Parameter Groups

Parameter descriptions and selections are displayed on the graphic (GLCP) or numeric (NLCP) in the display area. (See Section 5 for details.) Access the parameters by pressing the [Quick Menu] or [Main Menu] key on the control panel. The quick menu is used primarily for commissioning the unit at start-up by providing those parameters necessary to start operation. The main menu provides access to all parameters for detailed application programming.

All digital input/output and analog input/output terminals are multifunctional. All terminals have factory default functions suitable for the majority of water applications but if other special functions are required, they must be programmed in parameter group 5 or 6.

## 2

## 2.1 Main Menu - Operation and Display - Group 0

### 2.2.1 0-\*\* Operation / Display

Parameters related to the fundamental functions of the frequency converter, function of the LCP buttons and configuration of the LCP display.

### 2.2.2 0-0\* Basic Settings

Parameter group for basic frequency converter settings.

#### 0-01 Language

Option:	Function:
	Defines the language to be used in the display. The frequency converter can be delivered with 2 different language packages. English and German are included in both packages. English cannot be erased or manipulated.
[0] * English	Part of Language packages 1 - 2
[1] Deutsch	Part of Language packages 1 - 2
[2] Francais	Part of Language package 1
[3] Dansk	Part of Language package 1
[4] Spanish	Part of Language package 1
[5] Italiano	Part of Language package 1
[6] Svenska	Part of Language package 1
[7] Nederlands	Part of Language package 1
[10] Chinese	Language package 2
[20] Suomi	Part of Language package 1
[22] English US	Part of Language package 1
[27] Greek	Part of Language package 1
[28] Bras.port	Part of Language package 1
[36] Slovenian	Part of Language package 1
[39] Korean	Part of Language package 2
[40] Japanese	Part of Language package 2
[41] Turkish	Part of Language package 1
[42] Trad.Chinese	Part of Language package 2
[43] Bulgarian	Part of Language package 1
[44] Srpski	Part of Language package 1
[45] Romanian	Part of Language package 1
[46] Magyar	Part of Language package 1
[47] Czech	Part of Language package 1

[48]	Polski	Part of Language package 1
[49]	Russian	Part of Language package 1
[50]	Thai	Part of Language package 2
[51]	Bahasa Indonesia	Part of Language package 2
[52]	Hrvatski	

**0-02 Motor Speed Unit**

**Option:**

**Function:**

This parameter cannot be adjusted while the motor is running.  
The display showing depends on settings in par. 0-02 *Motor Speed Unit* and par. 0-03 *Regional Settings*. The default setting of par. 0-02 *Motor Speed Unit* and par. 0-03 *Regional Settings* depends on which region of the world the frequency converter is supplied to, but can be re-programmed as required.



**NB!**

Changing the *Motor Speed Unit* will reset certain parameters to their initial value. It is recommended to select the motor speed unit first, before modifying other parameters.

[0] \*      RPM                      Selects display of motor speed variables and parameters (i.e. references, feedbacks and limits) in terms of motor speed (RPM).

[1] \*      Hz                                Selects display of motor speed variables and parameters (i.e. references, feedbacks and limits) in terms of output frequency to the motor (Hz).

**0-03 Regional Settings**

**Option:**

**Function:**

This parameter cannot be adjusted while the motor is running.  
The display showing depends on settings in par. 0-02 *Motor Speed Unit* and par. 0-03 *Regional Settings*. The default setting of par. 0-02 *Motor Speed Unit* and par. 0-03 *Regional Settings* depends on which region of the world the frequency converter is supplied to but can be re-programmed as required.

[0] \*      International                      Sets par. 1-20 *Motor Power [kW]* units to [kW] and the default value of par. 1-23 *Motor Frequency* [50 Hz].

[1]        North America                      Sets par. 1-21 *Motor Power [HP]* units to HP and the default value of par. 1-23 *Motor Frequency* to 60 Hz.

The setting not used is made invisible.

### 0-04 Operating State at Power-up

#### Option:

#### Function:

Select the operating mode upon reconnection of the frequency converter to mains voltage after power down when operating in Hand (local)mode.

2

[0] \* Resume

Resumes operation of the frequency converter maintaining the same local reference and the same start/stop condition (applied by [Hand On]/[Off] on the LCP or Hand Start via a digital input as before the frequency converter was powered down.

[1] Forced stop, ref=old

Uses saved reference [1] to stop the frequency converter but at the same time retain in memory the local speed reference prior to power down. After mains voltage is reconnected and after receiving a start command (using the LCP [Hand On] button or Hand Start command via a digital input) the frequency converter restarts and operates at the retained speed reference.

### 2.2.3 0-1\* Set-up Operations

Define and control the individual parameter set-ups.

The frequency converter has four parameter setups that can be programmed independently of each other. This makes the frequency converter very flexible and able to meet the requirements of many different system control schemes often saving the cost of external control equipment. For example these can be used to program the frequency converter to operate according to one control scheme in one setup (e.g. daytime operation) and another control scheme in another setup (e.g. night set back). Alternatively they can be used by an AHU or packaged unit OEM to identically program all their factory fitted frequency converters for different equipment models within a range to have the same parameters and then during production/commissioning simply select a specific setup depending on which model within that range the frequency converter is installed on.

The active setup (i.e. the setup in which the frequency converter is currently operating) can be selected in parameter 0-10 and is displayed in the LCP. Using Multi set-up it is possible to switch between set-ups with the frequency converter running or stopped, via digital input or serial communication commands (e.g. for night set back). If it is necessary to change setups whilst running, ensure parameter 0-12 is programmed as required. For the majority of applications it will not be necessary to program parameter 0-12 even if change of set up whilst running is required, but for very complex applications, using the full flexibility of the multiple setups, it may be required. Using parameter 0-11 it is possible to edit parameters within any of the setups whilst continuing the frequency converter operation in its Active Setup which can be a different setup to that being edited. Using parameter 0-51 it is possible to copy parameter settings between the set-ups to enable quicker commissioning if similar parameter settings are required in different set-ups.

#### 0-10 Active Set-up

Option:	Function:
	Select the set-up in which the frequency converter is to operate. Use par. 0-51 <i>Set-up Copy</i> to copy a set-up to one or all other set-ups. To avoid conflicting settings of the same parameter within two different set-ups, link the set-ups together using par. 0-12 <i>This Set-up Linked to</i> . Stop the frequency converter before switching between set-ups where parameters marked 'not changeable during operation' have different values. Parameters which are 'not changeable during operation' are marked FALSE in the parameter lists in the section <i>Parameter Lists</i>
[0] Factory setup	Cannot be changed. It contains the Danfoss data set, and can be used as a data source when returning the other set-ups to a known state.
[1] * Set-up 1	<i>Set-up 1</i> [1] to <i>Set-up 4</i> [4] are the four separate parameter set-ups within which all parameters can be programmed.
[2] Set-up 2	
[3] Set-up 3	
[4] Set-up 4	
[9] Multi Set-up	Is used for remote selection of set-ups using digital inputs and the serial communication port. This set-up uses the settings from par. 0-12 <i>This Set-up Linked to</i> .

2

**0-11 Programming Set-up**

Option:	Function:
	Select the set-up to be edited (i.e. programmed) during operation; either the active set-up or one of the inactive set-ups. The set-up number being edited is displayed in the LCP in (brackets).
[0] Factory setup	cannot be edited but it is useful as a data source to return the other set-ups to a known state.
[1] Set-up 1	<i>Set-up 1</i> [1] to <i>Set-up 4</i> [4] can be edited freely during operation, independently of the active set-up.
[2] Set-up 2	
[3] Set-up 3	
[4] Set-up 4	
[9] * Active Set-up	(i.e. the set-up in which the frequency converter is operating) can also be edited during operation. Editing parameters in the chosen setup would normally be done from the LCP but it is also possible from any of the serial communication ports.

**0-12 This Set-up Linked to**

Option:	Function:
	<p>This parameter only needs to be programmed if changing set-ups is required whilst the motor is running. It ensures that parameters which are "not changeable during operation" have the same setting in all relevant set-ups.</p> <p>To enable conflict-free changes from one set-up to another whilst the frequency converter is running, link set-ups containing parameters which are not changeable during operation. The link will ensure synchronising of the 'not changeable during operation' parameter values when moving from one set-up to another during operation. 'Not changeable during operation' parameters can be identified by the label FALSE in the parameter lists in the section <i>Parameter Lists</i>.</p> <p>The par. 0-12 <i>This Set-up Linked to</i> feature is used when Multi set-up in par. 0-10 <i>Active Set-up</i> is selected. Multi set-up can be used to move from one set-up to another during operation (i.e. while the motor is running).</p> <p>Example:</p> <p>Use Multi set-up to shift from Set-up 1 to Set-up 2 whilst the motor is running. Programme parameters in Set-up 1 first, then ensure that Set-up 1 and Set-up 2 are synchronised (or 'linked'). Synchronisation can be performed in two ways:</p> <ol style="list-style-type: none"> <li>1. Change the edit set-up to <i>Set-up 2</i> [2] in par. 0-11 <i>Programming Set-up</i> and set par. 0-12 <i>This Set-up Linked to</i> to <i>Set-up 1</i> [1]. This will start the linking (synchronising) process.</li> </ol>
	<p>The screenshot shows a parameter menu with the following items: '0 RPM', '0.00A', '1(1)', 'Set-up Handling', '0-12 This Set-up Linked to', and 'Setup 1'. A vertical label '1308PC/5.10' is on the right side of the menu.</p>
	<p>OR</p> <ol style="list-style-type: none"> <li>2. While still in Set-up 1, using par. 0-50 <i>LCP Copy</i>, copy Set-up 1 to Set-up 2. Then set par. 0-12 <i>This Set-up Linked to</i> to <i>Set-up 2</i> [2]. This will start the linking process.</li> </ol>

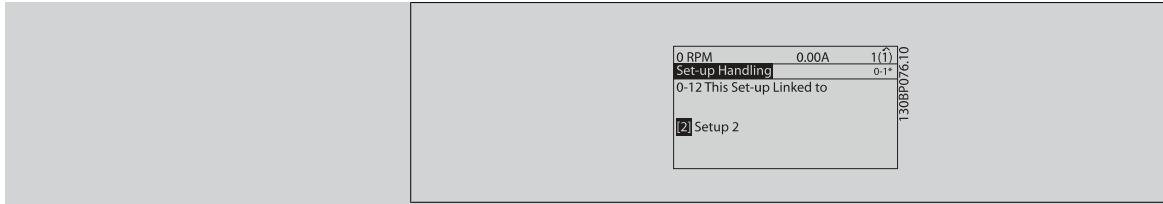

After the link is complete, par. 0-13 *Readout: Linked Set-ups* will read {1,2} to indicate that all 'not changeable during operation' parameters are now the same in Set-up 1 and Set-up 2. If there are changes to a 'not changeable during operation' parameter, e.g. par. 1-30 *Stator Resistance (Rs)*, in Set-up 2, they will also be changed automatically in Set-up 1. A switch between Set-up 1 and Set-up 2 during operation is now possible.

- [0] \* Not linked
- [1] Set-up 1
- [2] Set-up 2
- [3] Set-up 3
- [4] Set-up 4

**0-13 Readout: Linked Set-ups**

Array [5]

**Range:**

0\* [0 - 255 ]

**Function:**

View a list of all the set-ups linked by means of par. 0-12 *This Set-up Linked to*. The parameter has one index for each parameter set-up. The parameter value displayed for each index represents which setups are linked to that parameter setup.

Index	LCP value
0	{0}
1	{1,2}
2	{1,2}
3	{3}
4	{4}

Table 2.3: Example: Set-up 1 and Set-up 2 are linked

**0-14 Readout: Prog. Set-ups / Channel**

**Range:**

0\* [-2147483648 - 2147483647 ]

**Function:**

View the setting of par. 0-11 *Programming Set-up* for each of the four different communication channels. When the number is displayed in hex, as it is in the LCP, each number represents one channel.

Numbers 1-4 represent a set-up number; 'F' means factory setting; and 'A' means active set-up. The channels are, from right to left: LCP, FC bus, USB, HPPFB1.5.

Example: The number AAAAAA21h means that the FC bus selected Set-up 2 in par. 0-11 *Programming Set-up*, the LCP selected Set-up 1 and all others used the active set-up.

**2.2.4 0-2\* LCP Display**

Define the variables displayed in the Graphical Local Control Panel.

**NB!**

Please refer to par. 0-37 *Display Text 1*, par. 0-38 *Display Text 2* and par. 0-39 *Display Text 3* for information on how to write display texts

## 2

**0-20 Display Line 1.1 Small****Option:****Function:**

Select a variable for display in line 1, left position.

[0]	None	No display value selected
[37]	Display Text 1	Present control word
[38]	Display Text 2	Enables an individual text string to be written, for display in the LCP or to be read via serial communication.
[39]	Display Text 3	Enables an individual text string to be written, for display in the LCP or to be read via serial communication.
[89]	Date and Time Readout	Displays the current date and time.
[953]	Profibus Warning Word	Displays Profibus communication warnings.
[1005]	Readout Transmit Error Counter	View the number of CAN control transmission errors since the last power-up.
[1006]	Readout Receive Error Counter	View the number of CAN control receipt errors since the last power-up.
[1007]	Readout Bus Off Counter	View the number of Bus Off events since the last power-up.
[1013]	Warning Parameter	View a DeviceNet-specific warning word. One separate bit is assigned to every warning.
[1115]	LON Warning Word	Shows the LON-specific warnings.
[1117]	XIF Revision	Shows the version of the external interface file of the Neuron C chip on the LON option.
[1118]	LON Works Revision	Shows the software version of the application program of the Neuron C chip on the LON option.
[1500]	Operating Hours	View the number of running hours of the frequency converter.
[1501]	Running Hours	View the number of running hours of the motor.
[1502]	kWh Counter	View the mains power consumption in kWh.
[1600]	Control Word	View the Control Word sent from the frequency converter via the serial communication port in hex code.
[1601] *	Reference [Unit]	Total reference (sum of digital/analog/preset/bus/freeze ref./catch up and slow-down) in selected unit.
[1602]	Reference %	Total reference (sum of digital/analog/preset/bus/freeze ref./catch up and slow-down) in percent.
[1603]	Status Word	Present status word
[1605]	Main Actual Value [%]	One or more warnings in a Hex code
[1609]	Custom Readout	View the user-defined readouts as defined in par. 0-30, 0-31 and 0-32.
[1610]	Power [kW]	Actual power consumed by the motor in kW.
[1611]	Power [hp]	Actual power consumed by the motor in HP.
[1612]	Motor Voltage	Voltage supplied to the motor.
[1613]	Motor Frequency	Motor frequency, i.e. the output frequency from the frequency converter in Hz.
[1614]	Motor Current	Phase current of the motor measured as effective value.
[1615]	Frequency [%]	Motor frequency, i.e. the output frequency from the frequency converter in percent.
[1616]	Torque [Nm]	Present motor load as a percentage of the rated motor torque.
[1617]	Speed [RPM]	Speed in RPM (revolutions per minute) i.e. the motor shaft speed in closed loop based on the entered motor nameplate data, the output frequency and the load on the frequency converter.
[1618]	Motor Thermal	Thermal load on the motor, calculated by the ETR function. See also parameter group 1-9* Motor Temperature.

[1622]	Torque [%]	Shows the actual torque produced, in percentage.
[1630]	DC Link Voltage	Intermediate circuit voltage in the frequency converter.
[1632]	BrakeEnergy/s	Present brake power transferred to an external brake resistor. Stated as an instantaneous value.
[1633]	BrakeEnergy/2 min	Brake power transferred to an external brake resistor. The mean power is calculated continuously for the most recent 120 seconds.
[1634]	Heatsink Temp.	Present heat sink temperature of the frequency converter. The cut-out limit is 95 ±5 °C; cutting back in occurs at 70 ±5° C.
[1635]	Thermal Drive Load	Percentage load of the inverters
[1636]	Inv. Nom. Current	Nominal current of the frequency converter
[1637]	Inv. Max. Current	Maximum current of the frequency converter
[1638]	SL Control State	State of the event executed by the control
[1639]	Control Card Temp.	Temperature of the control card.
[1650]	External Reference	Sum of the external reference as a percentage, i.e. the sum of analog/pulse/bus.
[1652]	Feedback [Unit]	Signal value in units from the programmed digital input(s).
[1653]	Digi Pot Reference	View the contribution of the digital potentiometer to the actual reference Feedback.
[1654]	Feedback 1 [Unit]	View the value of Feedback 1. See also par. 20-0*.
[1655]	Feedback 2 [Unit]	View the value of Feedback 2. See also par. 20-0*.
[1656]	Feedback 3 [Unit]	View the value of Feedback 3. See also par. 20-0*.
[1658]	PID Output [%]	Returns the Drive Closed Loop PID controller output value in percent.
[1659]	Adjusted Setpoint	Displays the actual operating set-point after it is modified by flow compensation. See parameters 22-8*.
[1660]	Digital Input	Displays the status of the digital inputs. Signal low = 0; Signal high = 1. Regarding order, see par. 16-60. Bit 0 is at the extreme right.
[1661]	Terminal 53 Switch Setting	Setting of input terminal 53. Current = 0; Voltage = 1.
[1662]	Analog Input 53	Actual value at input 53 either as a reference or protection value.
[1663]	Terminal 54 Switch Setting	Setting of input terminal 54. Current = 0; Voltage = 1.
[1664]	Analog Input 54	Actual value at input 54 either as reference or protection value.
[1665]	Analog Output 42 [mA]	Actual value at output 42 in mA. Use par. 6-50 to select the variable to be represented by output 42.
[1666]	Digital Output [bin]	Binary value of all digital outputs.
[1667]	Freq. Input #29 [Hz]	Actual value of the frequency applied at terminal 29 as a pulse input.
[1668]	Freq. Input #33 [Hz]	Actual value of the frequency applied at terminal 33 as a pulse input.
[1669]	Pulse Output #27 [Hz]	Actual value of pulses applied to terminal 27 in digital output mode.
[1670]	Pulse Output #29 [Hz]	Actual value of pulses applied to terminal 29 in digital output mode.
[1671]	Relay Output [bin]	View the setting of all relays.
[1672]	Counter A	View the present value of Counter A.
[1673]	Counter B	View the present value of Counter B.
[1675]	Analog input X30/11	Actual value of the signal on input X30/11 (General Purpose I/O Card. Option)
[1676]	Analog input X30/12	Actual value of the signal on input X30/12 (General Purpose I/O Card. Optional)
[1677]	Analog output X30/8 [mA]	Actual value at output X30/8 (General Purpose I/O Card. Optional) Use Par. 6-60 to select the variable to be shown.
[1680]	Fieldbus CTW 1	Control word (CTW) received from the Bus Master.
[1682]	Fieldbus REF 1	Main reference value sent with control word via the serial communications network e.g. from the BMS, PLC or other master controller.

[1684]	Comm. Option STW	Extended fieldbus communication option status word.
[1685]	FC Port CTW 1	Control word (CTW) received from the Bus Master.
[1686]	FC Port REF 1	Status word (STW) sent to the Bus Master.
[1690]	Alarm Word	One or more alarms in a Hex code (used for serial communications)
[1691]	Alarm Word 2	One or more alarms in a Hex code (used for serial communications)
[1692]	Warning Word	One or more warnings in a Hex code (used for serial communications)
[1693]	Warning Word 2	One or more warnings in a Hex code (used for serial communications)
[1694]	Ext. Status Word	One or more status conditions in a Hex code (used for serial communications)
[1695]	Ext. Status Word 2	One or more status conditions in a Hex code (used for serial communications)
[1696]	Maintenance Word	The bits reflect the status for the programmed Preventive Maintenance Events in parameter group 23-1*
[1830]	Analog Input X42/1	Shows the value of the signal applied to terminal X42/1 on the Analog I/O card.
[1831]	Analog Input X42/3	Shows the value of the signal applied to terminal X42/3 on the Analog I/O card.
[1832]	Analog Input X42/5	Shows the value of the signal applied to terminal X42/5 on the Analog I/O card.
[1833]	Analog Out X42/7 [V]	Shows the value of the signal applied to terminal X42/7 on the Analog I/O card.
[1834]	Analog Out X42/9 [V]	Shows the value of the signal applied to terminal X42/9 on the Analog I/O card.
[1835]	Analog Out X42/11 [V]	Shows the value of the signal applied to terminal X42/11 on the Analog I/O card.
[2117]	Ext. 1 Reference [Unit]	The value of the reference for extended Closed Loop Controller 1
[2118]	Ext. 1 Feedback [Unit]	The value of the feedback signal for extended Closed Loop Controller 1
[2119]	Ext. 1 Output [%]	The value of the output from extended Closed Loop Controller 1
[2137]	Ext. 2 Reference [Unit]	The value of the reference for extended Closed Loop Controller 2
[2138]	Ext. 2 Feedback [Unit]	The value of the feedback signal for extended Closed Loop Controller 2
[2139]	Ext. 2 Output [%]	The value of the output from extended Closed Loop Controller 2
[2157]	Ext. 3 Reference [Unit]	The value of the reference for extended Closed Loop Controller 3
[2158]	Ext. 3 Feedback [Unit]	The value of the feedback signal for extended Closed Loop Controller 3
[2159]	Ext. Output [%]	The value of the output from extended Closed Loop Controller 3
[2230]	No-Flow Power	The calculated No Flow Power for the actual operating speed
[2580]	Cascade Status	Status for the operation of the Cascade Controller
[2581]	Pump Status	Status for the operation of each individual pump controlled by the Cascade Controller
[2791]	Cascade Reference	Reference output for use with follower drives.
[2792]	% Of Total Capacity	Readout parameter to show the system operating point as a % capacity of total system capacity.
[2793]	Cascade Option Status	Readout parameter to show the status of the cascade system.

### 0-21 Display Line 1.2 Small

**Option:**
**Function:**

Select a variable for display in line 1, middle position.

[1662] \* Analog input 53

The options are the same as those listed for par. 0-20 *Display Line 1.1 Small*.

### 0-22 Display Line 1.3 Small

**Option:**
**Function:**

Select a variable for display in line 1, right position.

[1614] \* Motor Current

The options are the same as those listed for par. 0-20 *Display Line 1.1 Small*.

**0-23 Display Line 2 Large**

Option:	Function:
[1615] * Frequency	Select a variable for display in line 2. The options are the same as those listed for par. 0-20 <i>Display Line 1.1 Small</i>

**0-24 Display Line 3 Large**

Option:	Function:
[1652] * Feedback [Unit]	Select a variable for display in line 2. The options are the same as those listed for par. 0-20 <i>Display Line 1.1 Small</i> .

**0-25 My Personal Menu**

Range:	Function:
Application [0 - 9999 ] dependent*	

**2.2.5 0-3\*LCP Custom Readout**

It is possible to customize the display elements for various purposes: \*Custom Readout. Value proportional to speed (Linear, squared or cubed depending on unit selected in par. 0-30 *Custom Readout Unit*) \*Display Text. Text string stored in a parameter.

Custom Readout

The calculated value to be displayed is based on settings in par. 0-30 *Custom Readout Unit*, par. 0-31 *Custom Readout Min Value* (linear only), par. 0-32 *Custom Readout Max Value*, par. 4-13 *Motor Speed High Limit [RPM]*, par. 4-14 *Motor Speed High Limit [Hz]* and actual speed.

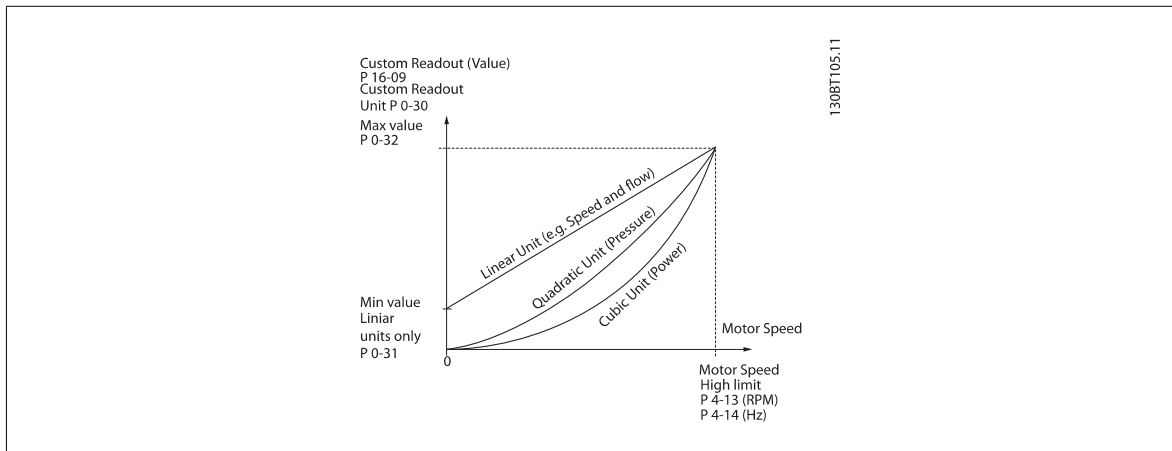

The relation will depend on the type of unit selected in par. 0-30 *Custom Readout Unit*.

Unit Type	Speed Relation
Dimensionless	Linear
Speed	
Flow, volume	
Flow, mass	
Velocity	
Length	
Temperature	
Pressure	Quadratic
Power	Cubic

### 0-30 Custom Readout Unit

#### Option:

#### Function:

Program a value to be shown in the display of the LCP. The value has a linear, squared or cubed relation to speed. This relation depends on the unit selected (see table above). The actual calculated value can be read in par. 16-09 *Custom Readout*, and/or shown in the display by selecting Custom Readout [16-09] in par. 0-20 *Display Line 1.1 Small* to par. 0-24 *Display Line 3 Large*.

[0]

[1] \* %

[5] PPM

[10] 1/min

[11] RPM

[12] Pulse/s

[20] l/s

[21] l/min

[22] l/h

[23] m<sup>3</sup>/s[24] m<sup>3</sup>/min[25] m<sup>3</sup>/h

[30] kg/s

[31] kg/min

[32] kg/h

[33] t/min

[34] t/h

[40] m/s

[41] m/min

[45] m

[60] °C

[70] mbar

[71] bar

[72] Pa

[73] kPa

[74] m WG

[75] mm Hg

[80] kW

[120]	GPM
[121]	gal/s
[122]	gal/min
[123]	gal/h
[124]	CFM
[125]	ft <sup>3</sup> /s
[126]	ft <sup>3</sup> /min
[127]	ft <sup>3</sup> /h
[130]	lb/s
[131]	lb/min
[132]	lb/h
[140]	ft/s
[141]	ft/min
[145]	ft
[160]	°F
[170]	psi
[171]	lb/in <sup>2</sup>
[172]	in WG
[173]	ft WG
[174]	in Hg
[180]	HP

**0-31 Custom Readout Min Value**

<b>Range:</b>	<b>Function:</b>
Application [Application dependant] dependent*	

**0-32 Custom Readout Max Value**

<b>Range:</b>	<b>Function:</b>
100.00 CustomReadoutUnit* [Application dependant]	This parameter sets the max value to be shown when the speed of the motor has reached the set value for par. 4-13 <i>Motor Speed High Limit [RPM]</i> or par. 4-14 <i>Motor Speed High Limit [Hz]</i> (depends on setting in par. 0-02).

**0-37 Display Text 1**

<b>Range:</b>	<b>Function:</b>
0* [0 - 0 ]	In this parameter it is possible to write an individual text string for display in the LCP or to be read via serial communication. If to be displayed permanently select Display Text 1 in par. 0-20 <i>Display Line 1.1 Small</i> , par. 0-21 <i>Display Line 1.2 Small</i> , par. 0-22 <i>Display Line 1.3 Small</i> , par. 0-23 <i>Display Line 2 Large</i> or par. 0-24 <i>Display Line 3 Large</i> . Use the ▲ or ▼ buttons on the LCP to change a character. Use the ◀ and ▶ buttons to move the cursor. When a character is highlighted by the cursor, it can be changed. Use the ▲ or ▼ buttons on the LCP to change a character. A character can be inserted by placing the cursor between two characters and pressing ▲ or ▼.

**0-38 Display Text 2****Range:**

0\* [0 - 0 ]

**Function:**

In this parameter it is possible to write an individual text string for display in the LCP or to be read via serial communication. If to be displayed permanently select Display Text 2 in par. 0-20 *Display Line 1.1 Small*, par. 0-21 *Display Line 1.2 Small*, par. 0-22 *Display Line 1.3 Small*, par. 0-23 *Display Line 2 Large* or par. 0-24 *Display Line 3 Large*. Use the ▲ or ▼ buttons on the LCP to change a character. Use the ◀ and ▶ buttons to move the cursor. When a character is highlighted by the cursor, this character can be changed. A character can be inserted by placing the cursor between two characters and pressing ▲ or ▼.

**0-39 Display Text 3****Range:**

0\* [0 - 0 ]

**Function:**

In this parameter it is possible to write an individual text string for display in the LCP or to be read via serial communication. If to be displayed permanently select Display Text 3 in par. 0-20 *Display Line 1.1 Small*, par. 0-21 *Display Line 1.2 Small*, par. 0-22 *Display Line 1.3 Small*, par. 0-23 *Display Line 2 Large* or par. 0-24 *Display Line 3 Large*. Use the ▲ or ▼ buttons on the LCP to change a character. Use the ◀ and ▶ buttons to move the cursor. When a character is highlighted by the cursor, this character can be changed. A character can be inserted by placing the cursor between two characters and pressing ▲ or ▼.

**2.2.6 0-4\* LCP Keypad**

Enable, disable and password protect individual keys on the LCP.

**0-40 [Hand on] Key on LCP****Option:**

[0] Disabled

**Function:**

No function

[1] \* Enabled

[Hand on] Key enabled

[2] Password

Avoid unauthorized start in Hand mode. If par. 0-40 *[Hand on] Key on LCPs* included in the My Personal Menu, then define the password in par. 0-65 *Personal Menu Password*. Otherwise define the password in par. 0-60 *Main Menu Password*.

[3] Hand Off/On

[4] Hand Off/On w. Passw.

**0-41 [Off] Key on LCP****Option:**

[0] Disabled

**Function:**

No function

[1] \* Enabled

[Off] Key is enabled

[2] Password

Avoid unauthorized stop. If par. 0-41 *[Off] Key on LCP*–41 [Off] Key on LCP is included in the My Personal Menu, then define the password in par. 0-65 *Personal Menu Password*–65 Personal Menu Password. Otherwise define the password in par. 0-60 *Main Menu Password*–60 Main Menu Password.

[3] Hand Off/On

[4] Hand Off/On w. Passw.

**0-42 [Auto on] Key on LCP**

Option:	Function:
[0] Disabled	No function
[1] * Enabled	[Auto on] Key is enabled
[2] Password	Avoid unauthorized start in Auto mode. If par. 0-42 [Auto on] Key on LCP is included in the My Personal Menu, then define the password in par. 0-65 <i>Personal Menu Password</i> . Otherwise define the password in par. 0-60 <i>Main Menu Password</i> .
[3] Hand Off/On	
[4] Hand Off/On w. Passw.	

**0-43 [Reset] Key on LCP**

Option:	Function:
[0] Disabled	No function
[1] * Enabled	[Reset] Key is enabled
[2] Password	Avoid unauthorized resetting. If par. 0-43 [Reset] Key on LCP is included in the par. 0-25 <i>My Personal Menu</i> , then define the password in par. 0-65 <i>Personal Menu Password</i> . Otherwise define the password in par. 0-60 <i>Main Menu Password</i> .
[3] Hand Off/On	
[4] Hand Off/On w. Passw.	

**2.2.7 0-5\* Copy / Save**

Copy parameter settings between set-ups and to/from the LCP.

**0-50 LCP Copy**

Option:	Function:
[0] * No copy	No function
[1] All to LCP	Copies all parameters in all set-ups from the frequency converter memory to the LCP memory. For service purposes it is recommended to copy all parameters to the LCP after commissioning.
[2] All from LCP	Copies all parameters in all set-ups from the LCP memory to the frequency converter memory.
[3] Size indep. from LCP	Copies only the parameters that are independent of the motor size. The latter selection can be used to programme several frequency converters with the same function without disturbing motor data which are already set.

This parameter cannot be adjusted while the motor is running.

### 0-51 Set-up Copy

Option:		Function:
[0] *	No copy	No function
[1]	Copy to set-up 1	Copies all parameters in the present Programming Set-up (defined in par. 0-11 <i>Programming Set-up</i> ) to Set-up 1.
[2]	Copy to set-up 2	Copies all parameters in the present Programming Set-up (defined in par. 0-11 <i>Programming Set-up</i> ) to Set-up 2.
[3]	Copy to set-up 3	Copies all parameters in the present Programming Set-up (defined in par. 0-11 <i>Programming Set-up</i> ) to Set-up 3.
[4]	Copy to set-up 4	Copies all parameters in the present Programming Set-up (defined in par. 0-11 <i>Programming Set-up</i> ) to Set-up 4.
[9]	Copy to all	Copies the parameters in the present set-up over to each of the set-ups 1 to 4.

2

### 2.2.8 0-6\* Password

Define password access to menus.

0-60 Main Menu Password		
Range:		Function:
100*	[-9999 - 9999 ]	Define the password for access to the Main Menu via the [Main Menu] key. If par. 0-61 <i>Access to Main Menu w/o Password</i> is set to <i>Full access</i> [0], this parameter will be ignored.

0-61 Access to Main Menu w/o Password		
Option:		Function:
[0] *	Full access	Disables password defined in par. 0-60 <i>Main Menu Password</i> .
[1]	LCP: Read only	Prevent unauthorized editing of Main Menu parameters.
[2]	LCP: No access	Prevent unauthorized viewing and editing of Main Menu parameters.
[3]	Bus: Read only	
[4]	Bus: No access	
[5]	All: Read only	
[6]	All: No access	

If *Full access* [0] is selected then par. 0-60 *Main Menu Password*, par. 0-65 *Personal Menu Password* and par. 0-66 *Access to Personal Menu w/o Password* will be ignored.

0-65 Personal Menu Password		
Range:		Function:
200*	[0 - 999 ]	Define the password for access to the My Personal Menu via the [Quick Menu] key. If par. 0-66 <i>Access to Personal Menu w/o Password</i> is set to <i>Full access</i> [0], this parameter will be ignored.

0-66 Access to Personal Menu w/o Password		
Option:		Function:
[0] *	Full access	Disables password defined in par. 0-65 <i>Personal Menu Password</i> .
[1]	LCP: Read only	Prevents unauthorized editing of My Personal Menu parameters.
[2]	LCP: No access	Prevents unauthorized viewing and editing of My Personal Menu parameters.
[3]	Bus: Read only	
[4]	Bus: No access	
[5]	All: Read only	
[6]	All: No access	

If par. 0-61 *Access to Main Menu w/o Password* is set to *Full access* [0], this parameter will be ignored.

### 2.2.9 0-7\* Clock Settings

Set the time and date of the internal clock. The internal clock can be used for e.g. Timed Actions, energy log, Trend Analysis, date/time stamps on alarms, Logged data and Preventive Maintenance.

It is possible to program the clock for Daylight Saving Time / summertime, weekly working days/non-working days including 20 exceptions (holidays etc.). Although the clock settings can be set via the LCP, they can also be set along with timed actions and preventative maintenance functions using the MCT10 software tool.

**NB!**

The frequency converter has no back up of the clock function and the set date/time will reset to default (2000-01-01 00:00) after a power down unless a Real Time Clock module with back up is installed. If no module with back up is installed, it is recommended the clock function is only used if the frequency converter is integrated into an external system using serial communications, with the system maintaining synchronization of control equipment clock times. In par. 0-79, *Clock Fault*, it is possible to program for a Warning in case clock has not been set properly, e.g. after a power down.

#### 0-70 Set Date and Time

**Range:**

2000-01-01 [2000-01-01 00:00]  
00:00 –  
2099-12-01  
23:59 \*

**Function:**

Sets the date and time of the internal clock. The format to be used is set in par. 0-71 and 0-72.

**NB!**

This parameter does not display the actual time. This can be read in par. 0-89. The clock will not begin counting until a setting different from default has been made.

#### 0-71 Date Format

**Option:**

[0] \* YYYY-MM-DD  
[1] DD-MM-YYYY  
[2] MM/DD/YYYY

**Function:**

Sets the date format to be used in the LCP.  
Sets the date format to be used in the LCP.  
Sets the date format to be used in the LCP.

#### 0-72 Time Format

**Option:**

[0] \* 24 h  
[1] 12 h

**Function:**

Sets the time format to be used in the LCP.

#### 0-73 Time Zone Offset

**Option:**

[0.00] -12.00 - 13.00

**Function:**

Sets the time zone offset to UTC, this is needed for automatic DST adjustment.

#### 0-74 DST/Summertime

**Option:**

[0] \* Off  
[2] Manual

**Function:**

Choose how Daylight Saving Time/Summertime should be handled. For manual DST/Summertime enter the start date and end date in par. 0-76 *DST/Summertime Start* and par. 0-77 *DST/Summertime End*.

**0-76 DST/Summertime Start**

**Range:** Application [Application dependant] dependent\*  
**Function:**

**0-77 DST/Summertime End**

**Range:** Application [Application dependant] dependent\*  
**Function:**

**0-79 Clock Fault**

**Option:** **Function:**  
Enables or disables the clock warning, when the clock has not been set or has been reset due to a power-down and no backup is installed.

[0] \* Disabled

[1] Enabled

**0-81 Working Days**

Array with 7 elements [0] - [6] displayed below parameter number in display. Press OK and step between elements by means of ▲ and ▼ buttons on the LCP.

**Option:** **Function:**  
Set for each weekday if it is a working day or a non-working day. First element of the array is Monday. The working days are used for Timed Actions.

[0] \* No

[1] Yes

**0-82 Additional Working Days**

Array with 5 elements [0] - [4] displayed below parameter number in display. Press OK and step between elements by means of ▲ and ▼ buttons on the LCP.

**Range:** Application [Application dependant] dependent\*  
**Function:**

**0-83 Additional Non-Working Days**

Array with 15 elements [0] - [14] displayed below parameter number in display. Press OK and step between elements by means of ▲ and ▼ buttons on the LCP.

**Range:** Application [Application dependant] dependent\*  
**Function:**

**0-89 Date and Time Readout**

**Range:** 0\* [0 - 0]  
**Function:** Displays the current date and time. The date and time is updated continuously. The clock will not begin counting until a setting different from default has been made in par. 0-70 *Date and Time*.

## 2

## 2.2 Main Menu - Load and Motor - Group 1

### 2.3.1 1-0\* General Settings

Define whether the frequency converter operates in open loop or closed loop.

#### 1-00 Configuration Mode

**Option:**
**Function:**

[0] \* Open Loop

Motor speed is determined by applying a speed reference or by setting desired speed when in Hand Mode.

Open Loop is also used if the frequency converter is part of a closed loop control system based on an external PID controller providing a speed reference signal as output.

[3] Closed Loop

Motor Speed will be determined by a reference from the built-in PID controller varying the motor speed as part of a closed loop control process (e.g. constant pressure or flow). The PID controller must be configured in par. 20-\*\* or via the Function Setups accessed by pressing the [Quick Menus] button.

**NB!**

This parameter cannot be changed when motor is running.

**NB!**

When set for Closed Loop, the commands Reversing and Start Reversing will not reverse the direction of the motor.

#### 1-01 Motor Control Principle

**Option:**
**Function:**

Select the motor control principle.

[0] U/f

#### 1-03 Torque Characteristics

**Option:**
**Function:**

[0] Constant Torque

For speed control of constant torque applications like axial pumps, positive displacement pumps and blowers. Provides a voltage which is optimized for a constant torque load characteristic of the motor in the entire speed range.

[1] Variable torque

For speed control of centrifugal pumps and fans. Also to be used when controlling more than one motor from the same frequency converter (e.g. multiple condenser fans or cooling tower fans). Provides a voltage which is optimized for a squared torque load characteristic of the motor.

[2] Auto energy optim. CT

For optimum energy efficient speed control of axial pumps, positive displacement (PD) pumps and blowers. Provides a voltage which is optimized for a constant torque load characteristic of the motor in the entire speed range but in addition the AEO feature will adapt the voltage exactly to the current load situation, thereby reducing energy consumption and audible noise from the motor. To obtain optimal performance, the motor power factor cos phi must be set correctly. This value is set in par. 14-43, Motor cos phi. The parameter has a default value which is automatically adjusted when the motor data is programmed. These settings will typically ensure optimum motor voltage but if the motor power factor cos phi requires tuning, an AMA function can be carried out using par. 1-29,

Automatic Motor Adaptation (AMA). It is very rarely necessary to adjust the motor power factor parameter manually.

<p>[3] * Auto energy optim. VT</p>	<p>For optimum energy efficient speed control of centrifugal pumps and fans. Provides a voltage which is optimized for a squared torque load characteristic of the motor but in addition the AEO feature will adapt the voltage exactly to the current load situation, thereby reducing energy consumption and audible noise from the motor. To obtain optimal performance, the motor power factor cos phi must be set correctly. This value is set in par. 14-43, Motor cos phi. The parameter has a default value and is automatically adjusted when the motor data is programmed. These settings will typically ensure optimum motor voltage but if the motor power factor cos phi requires tuning, an AMA function can be carried out using par. 1-29, Automatic Motor Adaptation (AMA). It is very rarely necessary to adjust the motor power factor parameter manually.</p>
------------------------------------	---

### 2.3.2 1-2\* Motor Data

Parameter group 1-2\* comprises input data from the nameplate on the connected motor.  
Parameters in parameter group 1-2\* cannot be adjusted while the motor is running.



**NB!**  
Changing the value of these parameters affects the setting of other parameters.

#### 1-20 Motor Power [kW]

<b>Range:</b>	<b>Function:</b>
Application [Application dependant] dependent*	

#### 1-21 Motor Power [HP]

<b>Range:</b>	<b>Function:</b>
Application [Application dependant] dependent*	

#### 1-22 Motor Voltage

<b>Range:</b>	<b>Function:</b>
Size rela- [200 - 1000 V] ted*	Enter the nominal motor voltage according to the motor nameplate data. The default value corresponds to the nominal rated output of the unit.

This parameter cannot be adjusted while the motor is running.

#### 1-23 Motor Frequency

<b>Range:</b>	<b>Function:</b>
Application [20 - 1000 Hz] dependent*	Select the motor frequency value from the motor nameplate data. For 87 Hz operation with 230/400 V motors, set the nameplate data for 230 V/50 Hz. Adapt par. 4-13 <i>Motor Speed High Limit [RPM]</i> and par. 3-03 <i>Maximum Reference</i> to the 87 Hz application.



**NB!**  
This parameter cannot be adjusted while the motor is running.

2

**1-24 Motor Current**

**Range:** Application [Application dependant] dependent\*      **Function:**

Application [Application dependant] dependent\*



**NB!**  
This parameter cannot be adjusted while the motor is running.

**1-25 Motor Nominal Speed**

**Range:** Application [100 - 60000 RPM] dependent\*      **Function:**

Application [100 - 60000 RPM] dependent\*

Enter the nominal motor speed value from the motor nameplate data. This data is used for calculating automatic motor compensations.



**NB!**  
This parameter cannot be changed while the motor is running.

**1-28 Motor Rotation Check**

**Option:**      **Function:**

Following installation and connection of the motor, this function allows the correct motor rotation direction to be verified. Enabling this function overrides any bus commands or digital inputs, except External Interlock and Safe Stop (if included).

[0] \*      Off      Motor Rotation Check is not active.

[1]      Enabled      Motor Rotation Check is enabled. Once enabled, Display shows:  
"Note! Motor may run in wrong direction".

Pressing [OK], [Back] or [Cancel] will dismiss the message and display a new message: "Press [Hand on] to start the motor. Press [Cancel] to abort". Pressing [Hand on] starts the motor at 5 Hz in forward direction and the display shows: "Motor is running. Check if motor rotation direction is correct. Press [Off] to stop the motor". Pressing [Off] stops the motor and resets par. 1-28 *Motor Rotation Check*. If motor rotation direction is incorrect, two motor phase cables should be interchanged. IMPORTANT:



Mains power must be removed before disconnecting motor phase cables.

**1-29 Automatic Motor Adaptation (AMA)**

Option:	Function:
	The AMA function optimizes dynamic motor performance by automatically optimizing the advanced motor parameters par. 1-30 <i>Stator Resistance (Rs)</i> to par. 1-35 <i>Main Reactance (Xh)</i> while the motor is stationary.
[0] * Off	No function
[1] Enable complete AMA	performs AMA of the stator resistance $R_s$ , the rotor resistance $R_r$ , the stator leakage reactance $X_{11}$ , the rotor leakage reactance $X_{22}$ and the main reactance $X_h$ .
[2] Enable reduced AMA	performs a reduced AMA of the stator resistance $R_s$ in the system only. Select this option if an LC filter is used between the frequency converter and the motor.

Activate the AMA function by pressing [Hand on] after selecting [1] or [2]. See also the section *Automatic Motor Adaptation*. After a normal sequence, the display will read: "Press [OK] to finish AMA". After pressing the [OK] key the frequency converter is ready for operation.

Note:

- For the best adaptation of the frequency converter, run AMA on a cold motor
- AMA cannot be performed while the motor is running

**NB!**  
It is important to set motor par. 1-2\* Motor Data correctly, since these form part of the AMA algorithm. An AMA must be performed to achieve optimum dynamic motor performance. It may take up to 10 min., depending on motor power rating.

**NB!**  
Avoid generating external torque during AMA

**NB!**  
If one of the settings in par. 1-2\* Motor Data is changed, par. 1-30 *Stator Resistance (Rs)* to par. 1-39 *Motor Poles*, the advanced motor parameters, will return to default setting.  
This parameter cannot be adjusted while the motor is running

**NB!**  
Full AMA should be run without filter only while reduced AMA should be run with filter.

See section: *Application Examples > Automatic Motor Adaptation* in the Design Guide.

**2.3.3 1-3\* Adv. Motor Data**

Parameters for advanced motor data. The motor data in par. 1-30 *Stator Resistance (Rs)* to par. 1-39 *Motor Poles* must match the relevant motor in order to run the motor optimally. The default settings are figures based on common motor parameter values from normal standard motors. If the motor parameters are not set correctly, a malfunction of the frequency converter system may occur. If the motor data is not known, running an AMA (Automatic Motor Adaptation) is recommended. See the *Automatic Motor Adaptation* section. The AMA sequence will adjust all motor parameters except the moment of inertia of the rotor and the iron loss resistance (par. 1-36 *Iron Loss Resistance (Rfe)*).

Par. 1-3\* and par. 1-4\* cannot be adjusted while the motor is running.

2

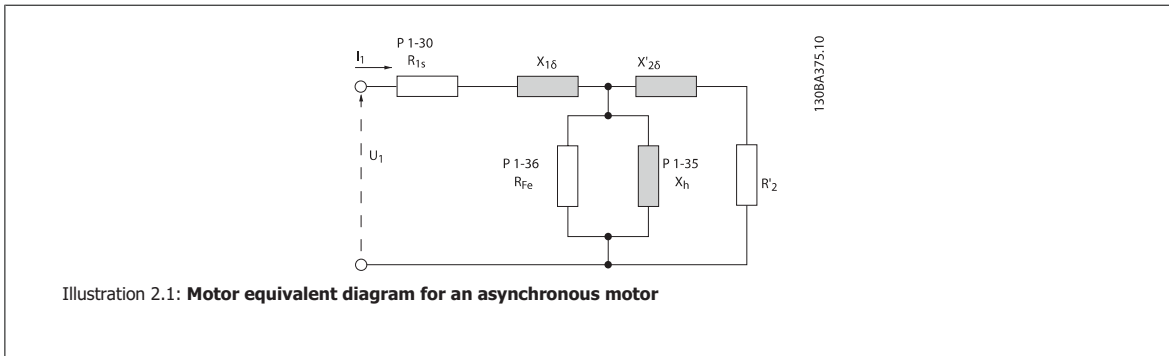

**1-30 Stator Resistance (Rs)**

Range:	Function:
Application [Application dependant] dependent*	

**1-35 Main Reactance (Xh)**

Range:	Function:
Application [Application dependant] dependent*	



**NB!**  
This parameter cannot be adjusted while running.

**1-36 Iron Loss Resistance (Rfe)**

Range:	Function:
Application [Application dependant] dependent*	



**NB!**  
This parameter cannot be adjusted while the motor is running.

**1-39 Motor Poles**

**Range:**

Application [ 2 - 100 ]  
 dependent\*

**Function:**

Enter the number of motor poles.

Poles	~n <sub>n</sub> @ 50 Hz	~n <sub>n</sub> @60 Hz
2	2700 - 2880	3250 - 3460
4	1350 - 1450	1625 - 1730
6	700 - 960	840 - 1153

The table shows the number of poles for normal speed ranges of various motor types. Define motors designed for other frequencies separately. The motor pole value is always an even number, because it refers to the total number of poles, not pairs of poles. The frequency converter creates the initial setting of par. 1-39 *Motor Poles* based on par. 1-23 *Motor Frequency Motor Frequency* and par. 1-25 *Motor Nominal Speed Motor Nominal Speed*.

This parameter cannot be adjusted while the motor is running.



### 2.3.4 1-5\* Load Indep. Setting

Parameters for setting the load-independent motor settings.

2

#### 1-50 Motor Magnetisation at Zero Speed

**Range:**

100 %\* [0 - 300 %]

**Function:**

Use this parameter along with par. 1-51 *Min Speed Normal Magnetising [RPM]* to obtain a different thermal load on the motor when running at low speed.

Enter a value which is a percentage of the rated magnetizing current. If the setting is too low, the torque on the motor shaft may be reduced.

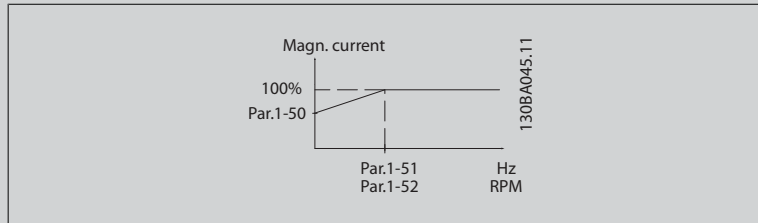

#### 1-51 Min Speed Normal Magnetising [RPM]

**Range:**

Application [10 - 300 RPM]  
dependent\*

**Function:**

Set the required speed for normal magnetising current. If the speed is set lower than the motor slip speed, par. 1-50 *Motor Magnetisation at Zero Speed* and par. 1-51 *Min Speed Normal Magnetising [RPM]* are of no significance.

Use this parameter along with par. 1-50 *Motor Magnetisation at Zero Speed*. See drawing for par. 1-50 *Motor Magnetisation at Zero Speed*.

#### 1-52 Min Speed Normal Magnetising [Hz]

**Range:**

Application [Application dependant]  
dependent\*

**Function:**

#### 1-55 V/f Characteristic - V

**Range:**

Application [0.0 - 1000.0 V]  
dependent\*

**Function:**

Enter the voltage at each frequency point to manually form a *U/f* characteristic matching the motor. The frequency points are defined in par. 1-56 *V/f Characteristic - f*.

This parameter is an array parameter [0-5] and is only accessible when par. 1-01 *Motor Control Principle* is set to *U/f[0]*.

#### 1-56 V/f Characteristic - f

**Range:**

Application [Application dependant]  
dependent\*

**Function:**

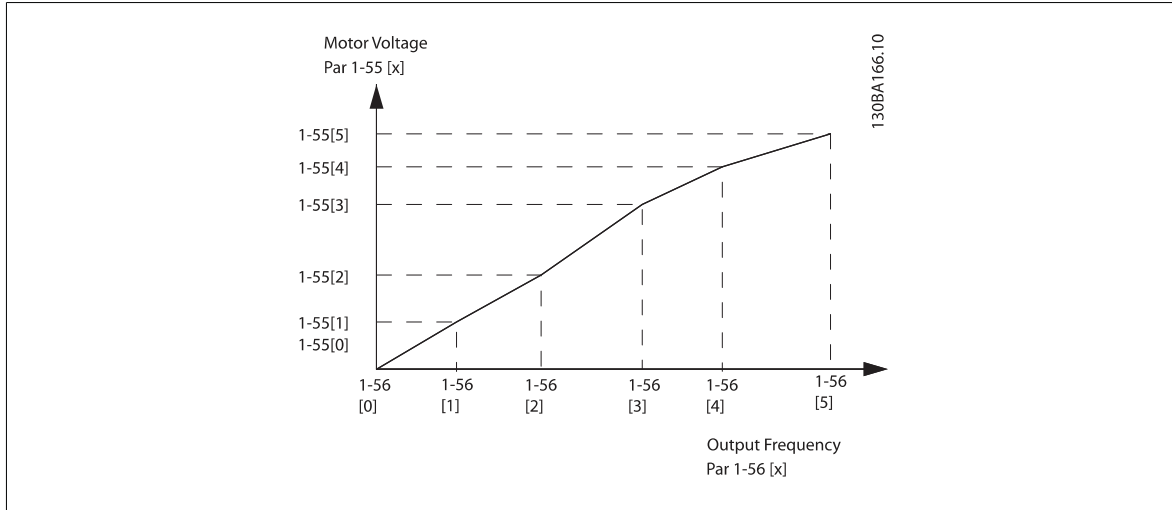

### 2.3.5 1-6\* Load Depend. Setting

Parameters for adjusting the load-dependent motor settings.

#### 1-60 Low Speed Load Compensation

**Range:**

100 %\* [0 - 300 %]

**Function:**

Enter the % value to compensate voltage in relation to load when the motor is running at low speed and obtain the optimum U/f characteristic. The motor size determines the frequency range within which this parameter is active.

Motor size	Change over
0.25 kW - 7.5 kW	< 10 Hz
11 kW - 45 kW	< 5 Hz
55 kW - 550 kW	< 3-4 Hz

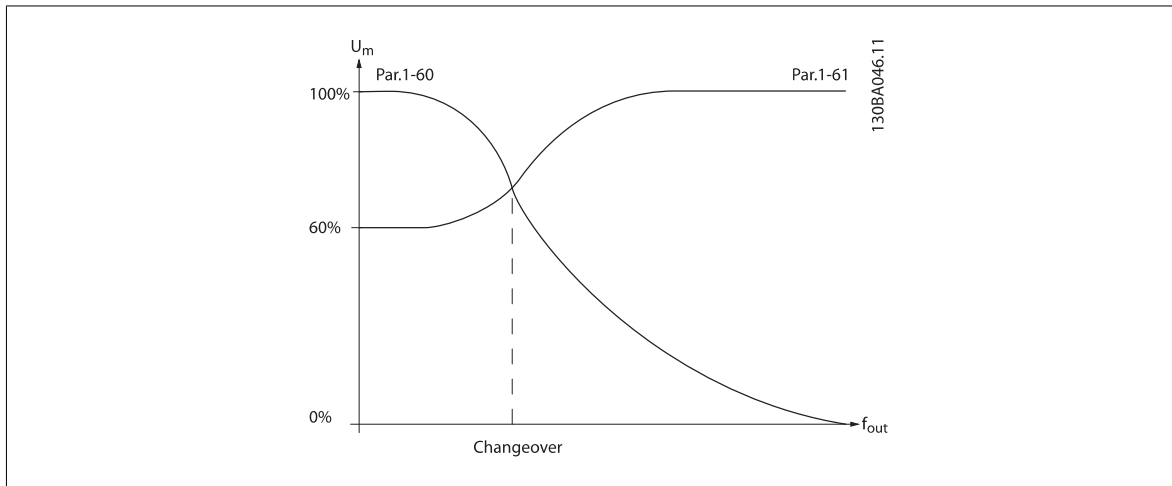

**1-61 High Speed Load Compensation****Range:**

100 %\* [0 - 300 %]

**Function:**

Enter the % value to compensate voltage in relation to load when the motor is running at high speed and obtain the optimum U/f characteristic. The motor size determines the frequency range within which this parameter is active.

Motor size	Change-over
0.25 kW - 7.5 kW	> 10 Hz
11 kW - 45 kW	< 5 Hz
55 kW - 550 kW	< 3-4 Hz

**1-62 Slip Compensation****Range:**

0 %\* [-500 - 500 %]

**Function:**

Enter the % value for slip compensation, to compensate for tolerances in the value of  $n_{M,N}$ . Slip compensation is calculated automatically, i.e. on the basis of the rated motor speed  $n_{M,N}$ .

**1-63 Slip Compensation Time Constant****Range:**Application [0.05 - 5.00 s]  
dependent\***Function:**

Enter the slip compensation reaction speed. A high value results in slow reaction, and a low value results in quick reaction. If low-frequency resonance problems arise, use a longer time setting.

**1-64 Resonance Dampening****Range:**

100 %\* [0 - 500 %]

**Function:**

Enter the resonance dampening value. Set par. 1-64 *Resonance Dampening* and par. 1-65 *Resonance Dampening Time Constant* to help eliminate high-frequency resonance problems. To reduce resonance oscillation, increase the value of par. 1-64 *Resonance Dampening*.

**1-65 Resonance Dampening Time Constant****Range:**

5 ms\* [5 - 50 ms]

**Function:**

Set par. 1-64 *Resonance Dampening* and par. 1-65 *Resonance Dampening Time Constant* to help eliminate high-frequency resonance problems. Enter the time constant that provides the best dampening.

**2.3.6 1-7\* Start Adjustments**

Parameters for setting special motor start features.

**1-71 Start Delay****Range:**

0.0 s\* [0.0 - 300.0 s]

**Function:**

The function selected in par. 1-80 *Function at Stop* is active in the delay period. Enter the time delay required before commencing acceleration.

### 1-73 Flying Start

Option:	Function:
[0] * Disabled	No function
[1] Enabled	Enables frequency converter to "catch" and control a spinning motor.

When par. 1-73 is enabled, par. 1-71 *Start Delay* has no function.

Search direction for flying start is linked to the setting in par. 4-10, Motor Speed Direction.

*Clockwise* [0]: Flying start search in clockwise direction. If not successful, a DC brake is carried out.

*Both Directions* [2]: The flying start will first make a search in the direction determined by the last reference (direction). If not finding the speed it will make a search in the other direction. If not successful, a DC brake will be activated in the time set in par. 2-02, Braking Time. Start will then take place from 0 Hz.

### 1-74 Start Speed [RPM]

Range:	Function:
Application [0 - 600 RPM] dependent*	Set a motor start speed. After the start signal, the output speed leaps to set value. Set the start function in par. 1-72 <i>Start Function</i> to [3], [4] or [5], and set a start delay time in par. 1-71 <i>Start Delay</i> .

### 1-75 Start Speed [Hz]

Range:	Function:
Application [Application dependant] dependent*	

### 1-76 Start Current

Range:	Function:
0.00 A* [Application dependant]	Some motors, e.g. cone rotor motors, need extra current/starting speed to disengage the rotor. To obtain this boost, set the required current in par. 1-76 <i>Start Current</i> . Set par. 1-74 <i>Start Speed [RPM]</i> . Set par. 1-72 <i>Start Function</i> to [3] or [4], and set a start delay time in par. 1-71 <i>Start Delay</i> .
	This parameter can be used for hoist applications (cone rotor).

## 2.3.7 1-8\* Stop Adjustments

Parameters for setting special stop features for the motor.

### 1-80 Function at Stop

Option:	Function:
	Select the frequency converter function after a stop command or after the speed is ramped down to the settings in par. 1-81 <i>Min Speed for Function at Stop [RPM]</i> .
[0] * Coast	Leaves motor in free mode.
[1] DC Hold/Motor Preheat	Energizes motor with a DC holding current (see par. 2-00 <i>DC Hold/Preheat Current</i> ).

### 1-81 Min Speed for Function at Stop [RPM]

Range:	Function:
Application [0 - 600 RPM] dependent*	Set the speed at which to activate par. 1-80 <i>Function at Stop</i> .

2

**1-82 Min Speed for Function at Stop [Hz]**

Range:	Function:
Application dependent* [Application dependant]	

**2.3.8 1-9\* Motor Temperature**

Parameters for setting the temperature protection features for the motor.

**1-90 Motor Thermal Protection**

Option:	Function:
	The frequency converter determines the motor temperature for motor protection in two different ways: <ul style="list-style-type: none"> <li>Via a thermistor sensor connected to one of the analog or digital inputs (par. 1-93 <i>Thermistor Source</i>).</li> <li>Via calculation (ETR = Electronic Thermal Relay) of the thermal load, based on the actual load and time. The calculated thermal load is compared with the rated motor current <math>I_{M,N}</math> and the rated motor frequency <math>f_{M,N}</math>. The calculations estimate the need for a lower load at lower speed due to less cooling from the fan incorporated in the motor.</li> </ul>
[0]	No protection If the motor is continuously overloaded and no warning or trip of frequency converter is wanted.
[1]	Thermistor warning Activates a warning when the connected thermistor in the motor reacts in the event of motor over-temperature.
[2]	Thermistor trip Stops (trips) the frequency converter when the connected thermistor in the motor reacts in the event of motor over-temperature.
[3]	ETR warning 1
[4] *	ETR trip 1
[5]	ETR warning 2
[6]	ETR trip 2
[7]	ETR warning 3
[8]	ETR trip 3
[9]	ETR warning 4
[10]	ETR trip 4

ETR (Electronic Thermal Relay) functions 1-4 will calculate the load when set-up where they were selected is active. For example ETR-3 starts calculating when set-up 3 is selected. For the North American market: The ETR functions provide class 20 motor overload protection in accordance with NEC.

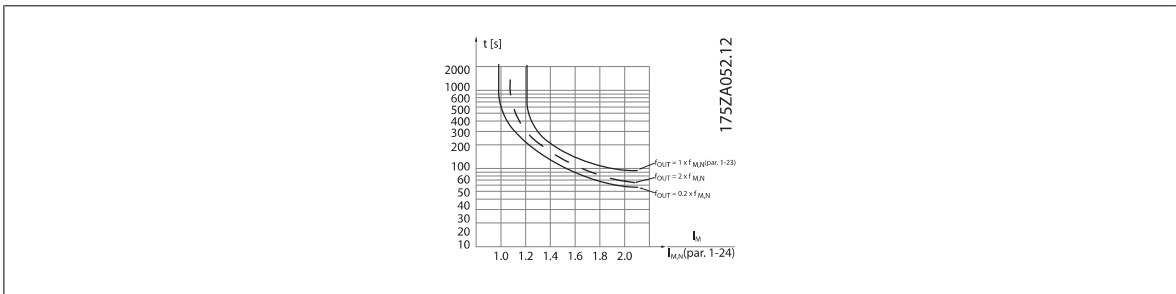

**1-91 Motor External Fan**

**Option:**

**Function:**

[0] \* No

No external fan is required, i.e. the motor is derated at low speed.

[1] Yes

Applies an external motor fan (external ventilation), so no derating of the motor is required at low speed. The graph below is followed if the motor current is lower than nominal motor current (see par. 1-24 *Motor Current*). If the motor current exceeds nominal current, the operation time still decreases as if no fan were installed.

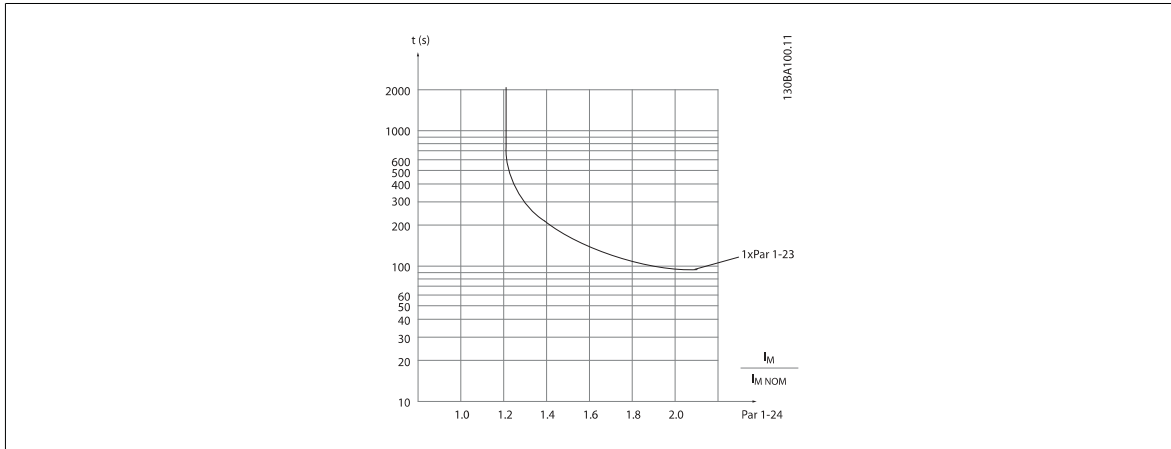

**1-93 Thermistor Source**

**Option:**

**Function:**

Select the input to which the thermistor (PTC sensor) should be connected. An analog input option [1] or [2] cannot be selected if the analog input is already in use as a reference source (selected in par. 3-15 *Reference 1 Source*, par. 3-16 *Reference 2 Source* or par. 3-17 *Reference 3 Source*). When using MCB112, choice [0] *None* must always be selected.

[0] \* None

[1] Analog input 53

[2] Analog input 54

[3] Digital input 18

[4] Digital input 19

[5] Digital input 32

[6] Digital input 33



**NB!**

This parameter cannot be adjusted while the motor is running.



**NB!**

Digital inputs should be set to "No operation" - see par. 5-1\*.

## 2.3 Main Menu - Brakes - Group 2

### 2.4.1 2-0\* DC-Brakes

2

Parameter group for configuring the DC brake and DC hold functions.

#### 2-00 DC Hold/Preheat Current

**Range:**

50 %\* [Application dependant]

**Function:**

Enter a value for holding current as a percentage of the rated motor current  $I_{M,N}$  set in par. 1-24 *Motor Current*. 100% DC holding current corresponds to  $I_{M,N}$ .

This parameter holds the motor (holding torque) or pre-heats the motor.

This parameter is active if [1] DC hold/Preheat is selected in par. 1-80 *Function at Stop*.

**NB!**

The maximum value depends on the rated motor current.

**NB!**

Avoid 100 % current for too long. It may damage the motor.

#### 2-01 DC Brake Current

**Range:**

50 %\* [Application dependant]

**Function:**

Enter a value for current as a percentage of the rated motor current  $I_{M,N}$ , see par. 1-24 *Motor Current*. 100% DC braking current corresponds to  $I_{M,N}$ .

DC brake current is applied on a stop command, when the speed is lower than the limit set in par. 2-03 *DC Brake Cut In Speed [RPM]*; when the DC Brake Inverse function is active; or via the serial communication port. The braking current is active during the time period set in par. 2-02 *DC Braking Time*.

**NB!**

The maximum value depends on the rated motor current.

**NB!**

Avoid 100 % current for too long. It may damage the motor.

#### 2-02 DC Braking Time

**Range:**

10.0 s\* [0.0 - 60.0 s]

**Function:**

Set the duration of the DC braking current set in par. 2-01 *DC Brake Current*, once activated.

#### 2-03 DC Brake Cut In Speed [RPM]

**Range:**

Application dependent\* [Application dependant]

**Function:**

## 2.4.2 2-1\* Brake Energy Funct.

Parameter group for selecting dynamic braking parameters.

### 2-10 Brake Function

Option:	Function:
[0] * Off	No brake resistor installed.
[1] Resistor brake	Brake resistor incorporated in the system, for dissipation of surplus brake energy as heat. Connecting a brake resistor allows a higher DC link voltage during braking (generating operation). The Resistor brake function is only active in frequency converters with an integral dynamic brake.
[2] AC brake	

### 2-11 Brake Resistor (ohm)

Range:	Function:
Application [Application dependant] dependent*	

### 2-12 Brake Power Limit (kW)

Range:	Function:
Application [Application dependant] dependent*	

This parameter is only active in frequency converters with an integral dynamic brake.

### 2-13 Brake Power Monitoring

Option:	Function:
	This parameter is only active in frequency converters with an integral dynamic brake. This parameter enables monitoring of the power to the brake resistor. The power is calculated on the basis of the resistance (par. 2-11 <i>Brake Resistor (ohm)</i> ), the DC link voltage, and the resistor duty time.
[0] * Off	No brake power monitoring is required.
[1] Warning	Activates a warning on the display when the power transmitted over 120 s exceeds 100% of the monitoring limit (par. 2-12 <i>Brake Power Limit (kW)</i> ). The warning disappears when the transmitted power falls below 80% of the monitoring limit.
[2] Trip	Trips the frequency converter and displays an alarm when the calculated power exceeds 100% of the monitoring limit.
[3] Warning and trip	Activates both of the above, including warning, trip and alarm.

If power monitoring is set to *Off*[0] or *Warning* [1], the brake function remains active even if the monitoring limit is exceeded. This may lead to thermal overload of the resistor. It is also possible to generate a warning via a relay/digital output. The measuring accuracy of the power monitoring depends on the accuracy of the resistance of the resistor (better than ± 20%).

### 2-15 Brake Check

#### Option:

#### Function:

Select type of test and monitoring function to check the connection to the brake resistor, or whether a brake resistor is present, and then display a warning or an alarm in the event of a fault. The brake resistor disconnection function is tested during power-up. However the brake IGBT test is performed when there is no braking. A warning or trip disconnects the brake function.

The testing sequence is as follows:

1. The DC link ripple amplitude is measured for 300 ms without braking.
2. The DC link ripple amplitude is measured for 300 ms with the brake turned on.
3. If the DC link ripple amplitude while braking is lower than the DC link ripple amplitude before braking + 1 %. Brake check failed, return a warning or alarm.
4. If the DC link ripple amplitude while braking is higher than the DC link ripple amplitude before braking + 1 %. Brake check OK.

[0] *	Off	Monitors brake resistor and brake IGBT for a short-circuit during operation. If a short-circuit occurs, a warning appears.
[1]	Warning	Monitors brake resistor and brake IGBT for a short-circuit, and to run a test for brake resistor disconnection during power-up
[2]	Trip	Monitors for a short-circuit or disconnection of the brake resistor, or a short-circuit of the brake IGBT. If a fault occurs the frequency converter cuts out while displaying an alarm (trip locked).
[3]	Stop and trip	Monitors for a short-circuit or disconnection of the brake resistor, or a short-circuit of the brake IGBT. If a fault occurs the frequency converter ramps down to coast and then trips. A trip lock alarm is displayed.
[4]	AC brake	



#### NB!

NB!: Remove a warning arising in connection with *Off*[0] or *Warning* [1] by cycling the mains supply. The fault must be corrected first. For *Off*[0] or *Warning* [1], the frequency converter keeps running even if a fault is located.

### 2-16 AC brake Max. Current

#### Range:

100.0 %\* [Application dependant]

#### Function:

Enter the maximum permissible current when using AC brake to avoid overheating of motor windings. The AC brake function is available in Flux mode only (FC 302 only).

### 2-17 Over-voltage Control

#### Option:

#### Function:

Over-voltage control (OVC) reduces the risk of the frequency converter tripping due to an over-voltage on the DC link caused by generative power from the load.

[0]	Disabled	No OVC required.
[2] *	Enabled	Activates OVC.



#### NB!

The ramp time is automatically adjusted to avoid tripping of the frequency converter.

## 2.4 Main Menu - Reference/Ramps - Group 3

### 2.5.1 3-0\* Reference Limits

Parameters for setting the reference unit, limits and ranges.

#### 3-02 Minimum Reference

**Range:** Application dependent\*      **Function:**

Application [Application dependant]  
dependent\*

#### 3-03 Maximum Reference

**Range:** Application dependent\*      **Function:**

Application [Application dependant]  
dependent\*

#### 3-04 Reference Function

**Option:** [0] \*      **Function:** Sum

Sums both external and preset reference sources.

[1]      External/Preset      Use either the preset or the external reference source.

Shift between external and preset via a command on a digital input.

### 2.5.2 3-1\* References

Parameters for setting up the reference sources.

Select the preset reference(s). *Select Preset ref. bit 0 / 1 / 2* [16], [17] or [18] for the corresponding digital inputs in parameter group 5.1\*.

#### 3-10 Preset Reference

Array [8]

**Range:** 0.00 %\*      **Function:** [-100.00 - 100.00 %]

Enter up to eight different preset references (0-7) in this parameter, using array programming. The preset reference is stated as a percentage of the value Ref<sub>MAX</sub> (par. 3-03 *Maximum Reference*, for closed loop see par. 20-14 *Maximum Reference/Feedb.*). When using preset references, select Preset ref. bit 0 / 1 / 2 [16], [17] or [18] for the corresponding digital inputs in parameter group 5-1\* Digital Inputs.

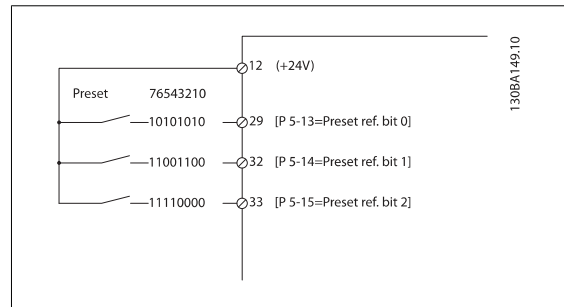
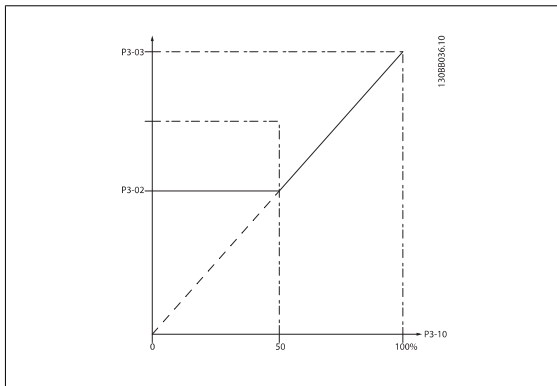

2

**3-11 Jog Speed [Hz]**

**Range:** Application [Application dependant] dependent\*  
**Function:**

**3-13 Reference Site**

Option:	Function:
	Select which reference site to activate.
[0] *      Linked to Hand / Auto	Use local reference when in Hand mode; or remote reference when in Auto mode.
[1]      Remote	Use remote reference in both Hand mode and Auto mode.
[2]      Local	Use local reference in both Hand mode and Auto mode.

**NB!**  
When set to Local [2], the frequency converter will start with this setting again following a 'power down'.

**3-14 Preset Relative Reference**

**Range:** 0.00 %\* [-100.00 - 100.00 %]  
**Function:** The actual reference, X, is increased or decreased with the percentage Y, set in par. 3-14 *Preset Relative Reference*. This results in the actual reference Z. Actual reference (X) is the sum of the inputs selected in par. 3-15 *Reference 1 Source*, par. 3-16 *Reference 2 Source*, par. 3-17 *Reference 3 Source* and par. 8-02 *Control Source*.

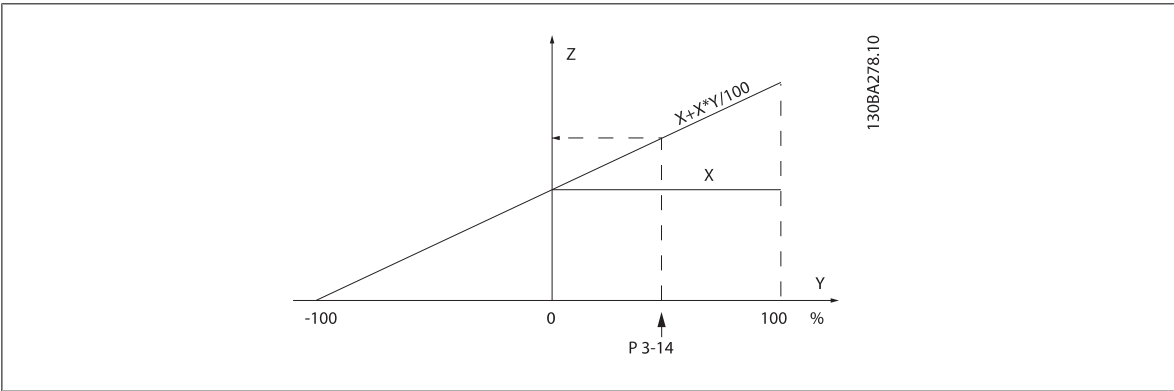
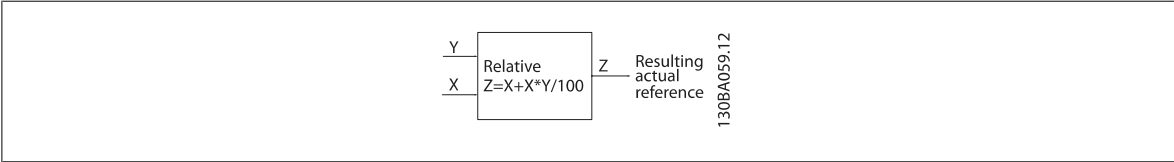

### 3-15 Reference 1 Source

**Option:**

**Function:**

Select the reference input to be used for the first reference signal. par. 3-15 *Reference 1 Source*, par. 3-16 *Reference 2 Source* and par. 3-17 *Reference 3 Source* define up to three different reference signals. The sum of these reference signals defines the actual reference.

This parameter cannot be adjusted while the motor is running.

- [0] No function
- [1] \* Analog input 53
- [2] Analog input 54
- [7] Pulse input 29
- [8] Pulse input 33
- [20] Digital pot.meter
- [21] Analog input X30/11
- [22] Analog input X30/12
- [23] Analog Input X42/1
- [24] Analog Input X42/3
- [25] Analog Input X42/5
- [29] Analog Input X48/2
- [30] Ext. Closed Loop 1
- [31] Ext. Closed Loop 2
- [32] Ext. Closed Loop 3

### 3-16 Reference 2 Source

**Option:**

**Function:**

Select the reference input to be used for the second reference signal. par. 3-15 *Reference 1 Source*, par. 3-16 *Reference 2 Source* and par. 3-17 *Reference 3 Source* define up to three different reference signals. The sum of these reference signals defines the actual reference.

This parameter cannot be adjusted while the motor is running.

- [0] \* No function
- [1] Analog input 53
- [2] Analog input 54
- [7] Pulse input 29
- [8] Pulse input 33
- [20] \* Digital pot.meter
- [21] Analog input X30/11
- [22] Analog input X30/12
- [23] Analog Input X42/1
- [24] Analog Input X42/3
- [25] Analog Input X42/5
- [29] Analog Input X48/2
- [30] Ext. Closed Loop 1
- [31] Ext. Closed Loop 2
- [32] Ext. Closed Loop 3

## 2

**3-17 Reference 3 Source****Option:****Function:**

Select the reference input to be used for the third reference signal. par. 3-15 *Reference 1 Source*, par. 3-16 *Reference 2 Source* and par. 3-17 *Reference 3 Source* define up to three different reference signals. The sum of these reference signals defines the actual reference.

This parameter cannot be adjusted while the motor is running.

[0] *	No function
[1]	Analog input 53
[2]	Analog input 54
[7]	Pulse input 29
[8]	Pulse input 33
[20]	Digital pot.meter
[21]	Analog input X30/11
[22]	Analog input X30/12
[23]	Analog Input X42/1
[24]	Analog Input X42/3
[25]	Analog Input X42/5
[29]	Analog Input X48/2
[30]	Ext. Closed Loop 1
[31]	Ext. Closed Loop 2
[32]	Ext. Closed Loop 3

**3-19 Jog Speed [RPM]****Range:****Function:**

Application [Application dependant]  
dependent\*

**2.5.3 3-4\* Ramp 1**

Configure the ramp parameter, ramping times, for each of the two ramps (par. 3-4\* and par. 3-5\*).

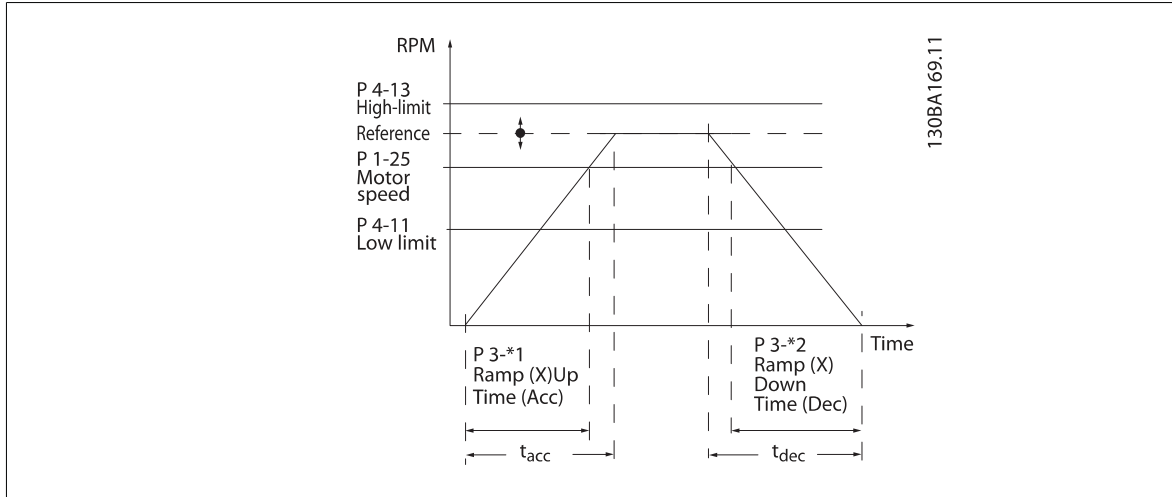

**3-41 Ramp 1 Ramp Up Time**

**Range:** [Application dependent]  
**Function:** dependent\*

**3-42 Ramp 1 Ramp Down Time**

**Range:** [Application dependent]  
**Function:** dependent\*

**2.5.4 3-5\* Ramp 2**

Choosing ramp parameters, see 3-4\*.

**3-51 Ramp 2 Ramp Up Time**

**Range:** [Application dependent]  
**Function:** dependent\*

**3-52 Ramp 2 Ramp Down Time**

**Range:** [Application dependent]  
**Function:** dependent\*

**2.5.5 3-8\* Other Ramps**

Configure parameters for special ramps e.g. Jog or Quick Stop.

2

**3-80 Jog Ramp Time**

**Range:**

Application [1.00 - 3600.00 s]  
dependent\*

**Function:**

Enter the jog ramp time, i.e. the acceleration/deceleration time between 0 RPM and the rated motor speed ( $n_{M,N}$ ) (set in par. 1-25 *Motor Nominal Speed*). Ensure that the resultant output current required for the given jog ramp time does not exceed the current limit in par. 4-18 *Current Limit*. The jog ramp time starts upon activation of a jog signal via the control panel, a selected digital input, or the serial communication port.

$$par. 3 - 80 = \frac{t_{jog} \times n_{norm} [par. 1 - 25]}{jog\ speed [par. 3 - 19]} [s]$$

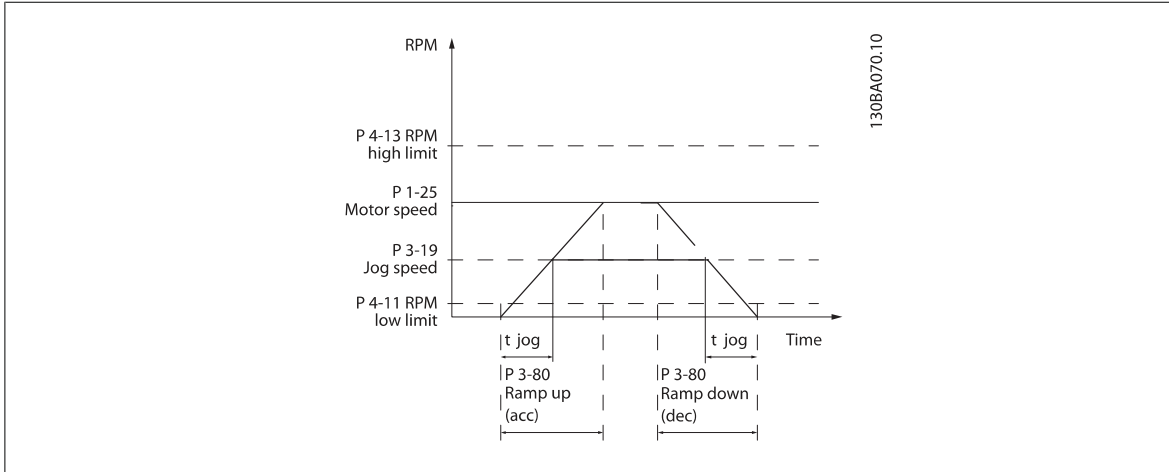

**3-84 Initial Ramp Time**

**Range:**

0 s\* [0 - 60 s]

**Function:**

Enter the initial ramp up time from zero speed to Motor Speed Low Limit, par. 4-11 or 4-12. Submersible deep well pumps can be damaged by running below minimum speed. A fast ramp time below minimum pump speed is recommended. This parameter may be applied as a fast ramp rate from zero speed to Motor Speed Low Limit.

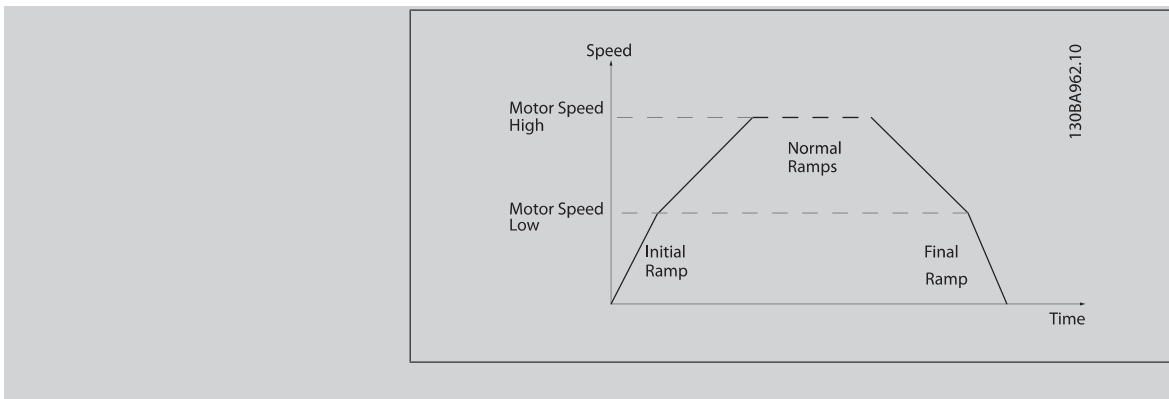

**3-85 Check Valve Ramp Time**

**Range:**

0 s\* [0 - 60 s]

**Function:**

In order to protect ball check valves in a stop situation, the check valve ramp can be utilized as a slow ramp rate from par. 4-11 *Motor Speed Low Limit [RPM]* or par. 4-12 *Motor Speed Low Limit [Hz]*, to Check Valve Ramp End Speed, set by the user in par. 3-86 or par. 3-87. When par. 3-85 is

different from 0 seconds, the Check Valve Ramp Time is effectuated and will be used to ramp down the speed from Motor Speed Low Limit to the Check Valve End Speed in par. 3-86 or par. 3-87.

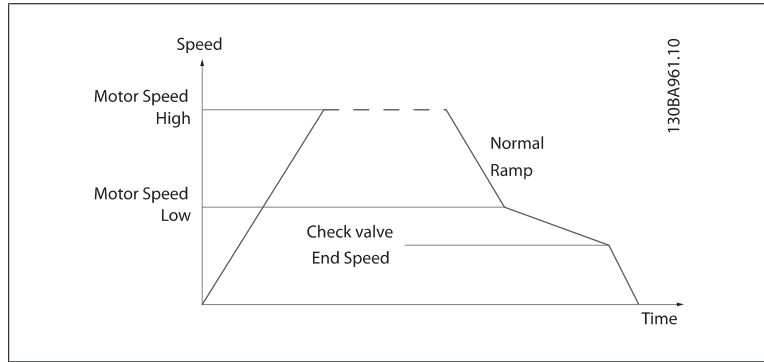

**3-86 Check Valve Ramp End Speed [RPM]**

**Range:**

0 [RPM]\* [0 – Motor Speed Low Limit [RPM]]

**Function:**

Set the speed in [RPM] below Motor Speed Low Limit where the Check Valve is expected to be closed and the Check Valve no longer shall be active.

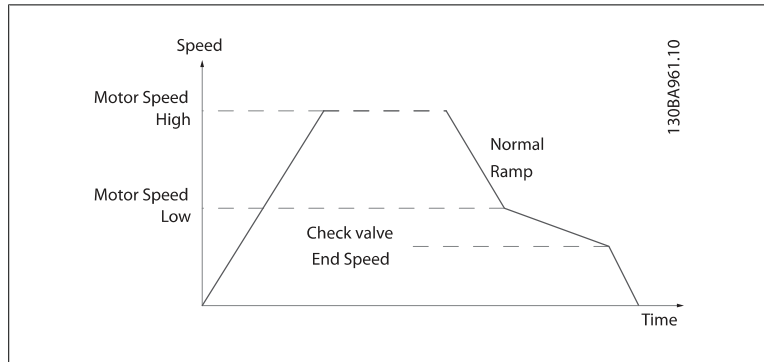

**3-87 Check Valve Ramp End Speed [Hz]**

**Range:**

0 [Hz]\* [0 – Motor Speed Low Limit [Hz]]

**Function:**

Set the speed in [Hz] below Motor Speed Low Limit where the Check Valve Ramp will no longer be active.

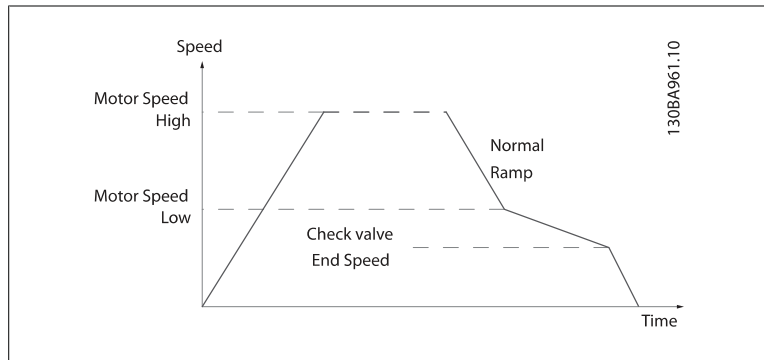

**3-88 Final Ramp Time****Range:**

0 [s]\* [0 – 60 [s]]

**Function:**

Enter the Final Ramp Time to be used when ramping down from Motor Speed Low Limit, par. 4-11 or 4-12, to zero speed.

Submersible deep well pumps can be damaged by running below minimum speed. A fast ramp time below minimum pump speed is recommended. This parameter may be applied as a fast ramp rate from Motor Speed Low Limit to zero speed.

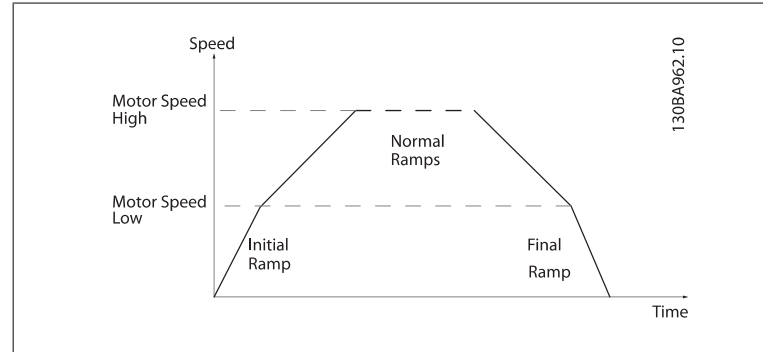
**2.5.6 3-9\* Digital Pot.Meter**

The digital potentiometer function allows the user to increase or decrease the actual reference by adjusting the set-up of the digital inputs using the functions INCREASE, DECREASE or CLEAR. To activate the function, at least one digital input must be set up to INCREASE or DECREASE.

**3-90 Step Size****Range:**

0.10 %\* [0.01 - 200.00 %]

**Function:**

Enter the increment size required for INCREASE/DECREASE, as a percentage of the synchronous motor speed,  $n_s$ . If INCREASE/ DECREASE is activated the resulting reference will be increased / decreased by the amount set in this parameter.

**3-91 Ramp Time****Range:**

1.00 s [0.00 - 3600.00 s]

**Function:**

Enter the ramp time, i.e. the time for adjustment of the reference from 0% to 100% of the specified digital potentiometer function (INCREASE, DECREASE or CLEAR).

If INCREASE / DECREASE is activated for longer than the ramp delay period specified in par. 3-95 *Ramp Delay* the actual reference will be ramped up / down according to this ramp time. The ramp time is defined as the time used to adjust the reference by the step size specified in par. 3-90 *Step Size*.

**3-92 Power Restore****Option:**

[0] \* Off

**Function:**

Resets the Digital Potentiometer reference to 0% after power up.

[1] On

Restores the most recent Digital Potentiometer reference at power up.

**3-93 Maximum Limit****Range:**

100 %\* [-200 - 200 %]

**Function:**

Set the maximum permissible value for the resultant reference. This is advisable if the Digital Potentiometer is used for fine tuning of the resulting reference.

**3-94 Minimum Limit**

**Range:**

0 %\* [-200 - 200 %]

**Function:**

Set the minimum permissible value for the resultant reference. This is advisable if the Digital Potentiometer is used for fine tuning of the resulting reference.

2

**3-95 Ramp Delay**

**Range:**

**Function:**

Application [Application dependant]  
dependent\*

**2**

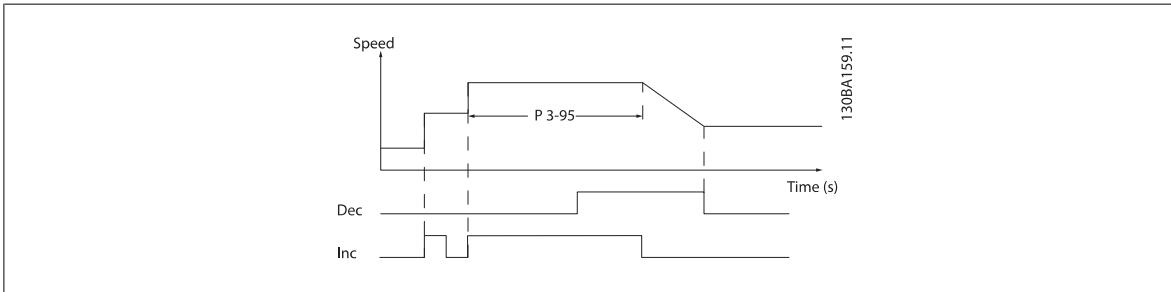
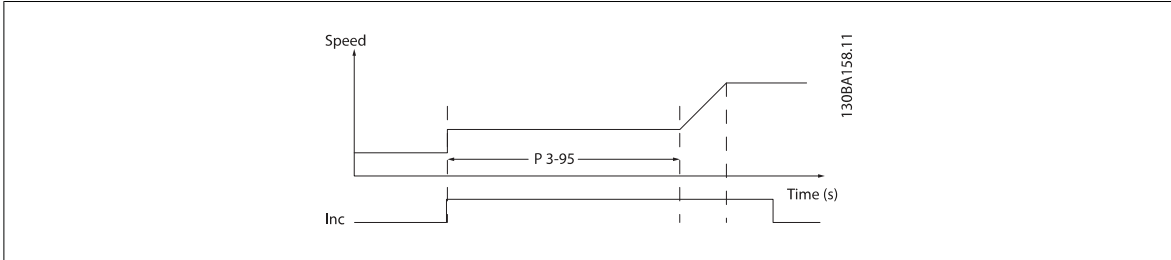

## 2.5 Main Menu - Limits/Warnings - Group 4

### 2.6.1 4-\*\* Limits and Warnings

Parameter group for configuring limits and warnings.

### 2.6.2 4-1\* Motor Limits

Define torque, current and speed limits for the motor, and the reaction of the frequency converter when the limits are exceeded.

A limit may generate a message on the display. A warning will always generate a message on the display or on the fieldbus. A monitoring function may initiate a warning or a trip, upon which the frequency converter will stop and generate an alarm message.

#### 4-10 Motor Speed Direction

**Option:**

**Function:**

Selects the motor speed direction required. When par. 1-00 Configuration Mode is set to Closed loop [3], the parameter default is changed to Clockwise [0]. If both directions are chosen, running in Counter Clockwise direction cannot be chosen from the LCP.

[0] \* Clockwise

[2] Both directions

Selects the motor speed direction required.

#### 4-11 Motor Speed Low Limit [RPM]

**Range:**

**Function:**

Application [Application dependant]  
dependant\*

#### 4-12 Motor Speed Low Limit [Hz]

**Range:**

**Function:**

Application [Application dependant]  
dependant\*

#### 4-13 Motor Speed High Limit [RPM]

**Range:**

**Function:**

Application [Application dependant]  
dependant\*



**NB!**

The output frequency value of the frequency converter must not exceed a value higher than 1/10 of the switching frequency.



**NB!**

Any changes in par. 4-13 *Motor Speed High Limit [RPM]* will reset the value in par. 4-53 *Warning Speed High* to the same value as set in par. 4-13 *Motor Speed High Limit [RPM]*.

**4-14 Motor Speed High Limit [Hz]****Range:** **Function:**Application [Application dependant]  
dependent\***NB!**Max. output frequency cannot exceed 10% of the inverter switching frequency (par. 14-01 *Switching Frequency*).**4-16 Torque Limit Motor Mode****Range:** **Function:**Application [Application dependant]  
dependent\***4-17 Torque Limit Generator Mode****Range:** **Function:**

100.0 %\* [Application dependant]

Enter the maximum torque limit for generator mode operation. The torque limit is active in the speed range up to and including the rated motor speed (par. 1-25 *Motor Nominal Speed*). Refer to par. 14-25 *Trip Delay at Torque Limit* for further details.If a setting in par. 1-00 *Configuration Mode* to par. 1-28 *Motor Rotation Check* is changed, par. 4-17 *Torque Limit Generator Mode* is not automatically reset to the default settings.**4-18 Current Limit****Range:** **Function:**

110 %\* [1 - 1000 %]

Enter the current limit for motor and generator operation. To protect the motor from reaching the stalling torque, the default setting is 1.1 x the rated motor torque (calculated value). If a setting in par. 1-00 to par. 1-26 is changed, par. 4-18 is not automatically reset to the default setting.

**4-19 Max Output Frequency****Range:** **Function:**Application [1.0 - 1000.0 Hz]  
dependent\*Enter the maximum output frequency value. par. 4-19 *Max Output Frequency* specifies the absolute limit on the frequency converter output frequency for improved safety in applications where accidental over-speeding must be avoided. This absolute limit applies to all configurations and is independent of the setting in par. 1-00 *Configuration Mode*. This parameter cannot be adjusted while the motor is running.

### 2.6.3 4-5\* Adj. Warnings

Define adjustable warning limits for current, speed, reference and feedback.

**NB!**  
Not visible in display, only in VLT Motion Control Tool, MCT 10.

2

Warnings are shown on display, programmed output or serial bus.

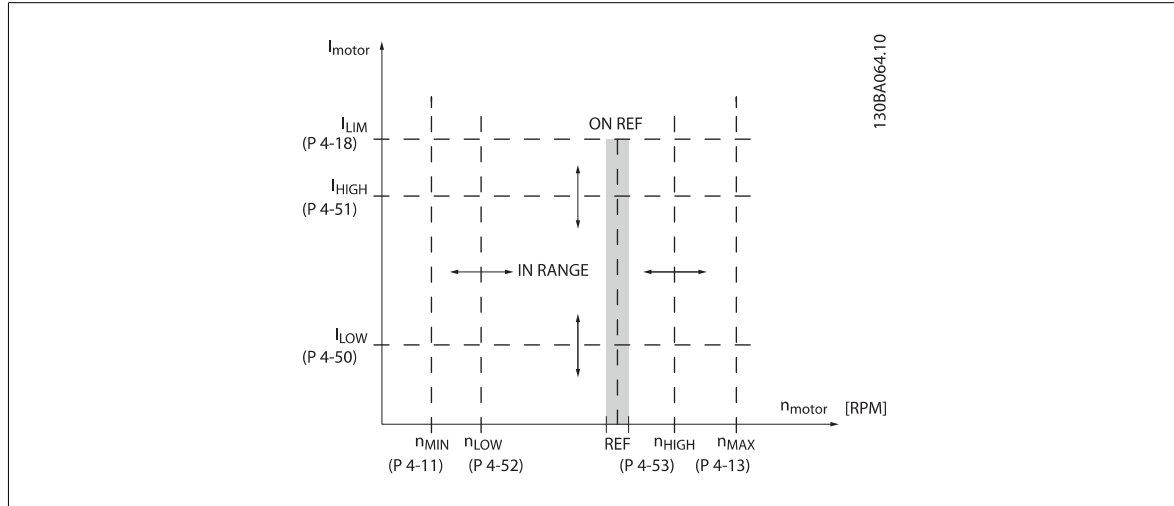

#### 4-50 Warning Current Low

<b>Range:</b>	<b>Function:</b>	
0.00 A* [Application dependant]	Enter the $I_{LOW}$ value. When the motor current falls below this limit ( $I_{LOW}$ ), the display reads CURRENT LOW. The signal outputs can be programmed to produce a status signal on terminal 27 or 29 and on relay output 01 or 02. Refer to the drawing in this section.	

#### 4-51 Warning Current High

<b>Range:</b>	<b>Function:</b>	
Application dependant* [Application dependant]		

#### 4-52 Warning Speed Low

<b>Range:</b>	<b>Function:</b>	
0 RPM* [Application dependant]	Enter the $n_{LOW}$ value. When the motor speed falls below this limit ( $n_{LOW}$ ) the display reads SPEED LOW. The signal outputs can be programmed to produce a status signal on terminal 27 or 29 and on relay output 01 or 02. Programme the lower signal limit of the motor speed, $n_{LOW}$ , within the normal working range of the frequency converter. Refer to the drawing in this section.	

**4-53 Warning Speed High****Range:** [Application dependant]

Application dependent\*

**Function:****NB!**

Any changes in par. 4-13 *Motor Speed High Limit [RPM]* will reset the value in par. 4-53 *Warning Speed High* to the same value as set in par. 4-13 *Motor Speed High Limit [RPM]*.

If a different value is needed in par. 4-53 *Warning Speed High*, it must be set after programming of par. 4-13 *Motor Speed High Limit [RPM]*.

**4-54 Warning Reference Low****Range:** -999999.99 [Application dependant]

9\*

**Function:**

Enter the lower reference limit. When the actual reference falls below this limit, the display indicates Ref Low. The signal outputs can be programmed to produce a status signal on terminal 27 or 29 and on relay output 01 or 02.

**4-55 Warning Reference High****Range:** 999999.999 [Application dependant]

\*

**Function:**

Enter the upper reference limit. When the actual reference exceeds this limit, the display reads Ref High. The signal outputs can be programmed to produce a status signal on terminal 27 or 29 and on relay output 01 or 02.

**4-56 Warning Feedback Low****Range:** -999999.99 [Application dependant]

9 ReferenceFeedback-Unit\*

**Function:**

Enter the lower feedback limit. When the feedback falls below this limit, the display reads Feedb Low. The signal outputs can be programmed to produce a status signal on terminal 27 or 29 and on relay output 01 or 02.

**4-57 Warning Feedback High****Range:** 999999.999 [Application dependant]

Reference-FeedbackUnit\*

**Function:**

Enter the upper feedback limit. When the feedback exceeds this limit, the display reads Feedb High. The signal outputs can be programmed to produce a status signal on terminal 27 or 29 and on relay output 01 or 02.

**4-58 Missing Motor Phase Function****Option:****Function:**

Displays an alarm in the event of a missing motor phase.

Select 100 ms to have a short detection time and alarm in the event of a missing motor phase. 100 ms is recommended for hoisting applications.

[0] Disabled

No alarm is displayed if a missing motor phase occurs.

[1] \* Trip 100 ms

An alarm is displayed if a missing motor phase occurs.

[2] \* Trip 1000 ms



**NB!**

This parameter cannot be adjusted while the motor is running.

## 2

### 2.6.4 4-6\* Speed Bypass

Define the Speed Bypass areas for the ramps.

Some systems call for avoiding certain output frequencies or speeds, due to resonance problems in the system. A maximum of four frequency or speed ranges can be avoided.

#### 4-60 Bypass Speed From [RPM]

Array [4]

**Range:** **Function:**

Application [Application dependant]  
dependent\*

#### 4-61 Bypass Speed From [Hz]

Array [4]

**Range:** **Function:**

Application [Application dependant]  
dependent\*

#### 4-62 Bypass Speed To [RPM]

Array [4]

**Range:** **Function:**

Application [Application dependant]  
dependent\*

#### 4-63 Bypass Speed To [Hz]

Array [4]

**Range:** **Function:**

Application [Application dependant]  
dependent\*

### 2.6.5 Semi-Automatic Bypass Speed Set-up

The Semi-Automatic Bypass Speed Setup can be used to facilitate the programming of the frequencies to be skipped due to resonances in the system.

The following process is to be carried out:

1. Stop the motor.
2. Select Enabled in par. 4-64 *Semi-Auto Bypass Set-up*.
3. Press *Hand On* on the LCP to start the search for frequency bands causing resonances. The motor will ramp up according to the ramp set.
4. When sweeping through a resonance band, press *OK* on the LCP when leaving the band. The actual frequency will be stored as the first element in par. 4-62 *Bypass Speed To [RPM]* or par. 4-63 *Bypass Speed To [Hz]* (array). Repeat this for each resonance band identified at the ramp-up (maximum four can be adjusted).
5. When maximum speed has been reached, the motor will automatically begin to ramp-down. Repeat the above procedure when speed is leaving the resonance bands during the deceleration. The actual frequencies registered when pressing *OK* will be stored in par. 4-60 *Bypass Speed From [RPM]* or par. 4-61 *Bypass Speed From [Hz]*.
6. When the motor has ramped down to stop, press *OK*. The par. 4-64 *Semi-Auto Bypass Set-up* will automatically reset to Off. The frequency converter will stay in *Hand* mode until *Off* or *Auto On* are pressed on the LCP.

If the frequencies for a certain resonance band are not registered in the right order (frequency values stored in *By Pass Speed To* are higher than those in *By Pass Speed From*) or if they do not have the same numbers of registrations for the *By Pass From* and *By Pass To*, all registrations will be cancelled and the following message is displayed: *Collected speed areas overlapping or not completely determined. Press [Cancel] to abort.*

**4-64 Semi-Auto Bypass Set-up**

<b>Option:</b>		<b>Function:</b>
[0] *	Off	No function
[1]	Enabled	Starts the Semi-Automatic Bypass set-up and continue with the procedure described above.

**2**

## 2

## 2.6 Main Menu - Digital In/Out - Group 5

### 2.7.1 5-\*\*-\*\* Digital In/Out

Parameter group for configuring the digital input and output.

### 2.7.2 5-0\* Digital I/O Mode

Parameters for configuring the input and output using NPN and PNP.

#### 5-00 Digital I/O Mode

Option:	Function:
	Digital inputs and programmed digital outputs are pre-programmable for operation either in PNP or NPN systems.
[0] * PNP - Active at 24V	Action on positive directional pulses (0). PNP systems are pulled down to GND.
[1] NPN - Active at 0V	Action on negative directional pulses (1). NPN systems are pulled up to + 24 V, internally in the frequency converter.



**NB!**

This parameter cannot be adjusted while the motor is running.

#### 5-01 Terminal 27 Mode

Option:	Function:
[0] * Input	Defines terminal 27 as a digital input.
[1] Output	Defines terminal 27 as a digital output.

Please note that this parameter cannot be adjusted while the motor is running.

#### 5-02 Terminal 29 Mode

Option:	Function:
[0] * Input	Defines terminal 29 as a digital input.
[1] Output	Defines terminal 29 as a digital output.

This parameter cannot be adjusted while the motor is running.

### 2.7.3 5-1\* Digital Inputs

Parameters for configuring the input functions for the input terminals.

The digital inputs are used for selecting various functions in the frequency converter. All digital inputs can be set to the following functions:

Digital input function	Select	Terminal
No operation	[0]	All *term 32, 33
Reset	[1]	All
Coast inverse	[2]	All
Coast and reset inverse	[3]	All
DC-brake inverse	[5]	All
Stop inverse	[6]	All
External interlock	[7]	All
Start	[8]	All *term 18
Latched start	[9]	All
Reversing	[10]	All *term 19
Start reversing	[11]	All
Jog	[14]	All *term 29
Preset reference on	[15]	All
Preset ref bit 0	[16]	All
Preset ref bit 1	[17]	All
Preset ref bit 2	[18]	All
Freeze reference	[19]	All
Freeze output	[20]	All
Speed up	[21]	All
Speed down	[22]	All
Set-up select bit 0	[23]	All
Set-up select bit 1	[24]	All
Pulse input	[32]	term 29, 33
Ramp bit 0	[34]	All
Mains failure inverse	[36]	All
Run Permissive	[52]	
Hand start	[53]	
Auto start	[54]	
DigiPot Increase	[55]	All
DigiPot Decrease	[56]	All
DigiPot Clear	[57]	All
Counter A (up)	[60]	29, 33
Counter A (down)	[61]	29, 33
Reset Counter A	[62]	All
Counter B (up)	[63]	29, 33
Counter B (down)	[64]	29, 33
Reset Counter B	[65]	All
Sleep Mode	[66]	
Reset Maintenance Word	[78]	
Lead Pump Start	[120]	
Lead Pump Alternation	[121]	
Pump 1 Interlock	[130]	
Pump 2 Interlock	[131]	
Pump 3 Interlock	[132]	

All = Terminals 18, 19, 27, 29, 32, X30/2, X30/3, X30/4. X30/ are the terminals on MCB 101.

Functions dedicated to only one digital input are stated in the associated parameter.

All digital inputs can be programmed to these functions:

## 2

[0]	No operation	No reaction to signals transmitted to terminal.
[1]	Reset	Resets frequency converter after a TRIP/ALARM. Not all alarms can be reset.
[2]	Coast inverse	Leaves motor in free mode. Logic '0' => coasting stop. (Default Digital input 27): Coasting stop, inverted input (NC).
[3]	Coast and reset inverse	Reset and coasting stop Inverted input (NC). Leaves motor in free mode and resets the frequency converter. Logic '0' => coasting stop and reset.
[5]	DC-brake inverse	Inverted input for DC braking (NC). Stops motor by energizing it with a DC current for a certain time period. See par. 2-01 to par. 2-03. The function is only active when the value in par. 2-02 is different from 0. Logic '0' => DC braking.
[6]	Stop inverse	Stop Inverted function. Generates a stop function when the selected terminal goes from logical level '1' to '0'. The stop is performed according to the selected ramp time (par. 3-42 and par. 3-52).
		<div style="border: 1px solid black; padding: 5px;">  <p><b>NB!</b> When the frequency converter is at the torque limit and has received a stop command, it may not stop by itself. To ensure that the frequency converter stops, configure a digital output to <i>Torque limit &amp; stop</i> [27] and connect this digital output to a digital input that is configured as coast.</p> </div>
[7]	External Interlock	Same function as Coasting stop, inverse, but External Interlock generates the alarm message 'external fault' on the display when the terminal which is programmed for Coast Inverse is logic '0'. The alarm message will also be active via digital outputs and relay outputs, if programmed for External Interlock. The alarm can be reset using a digital input or the [RESET] key if the cause for the External Interlock has been removed. A delay can be programmed in par. 22-00, External Interlock Time. After applying a signal to the input, the reaction described above will be delayed with the time set in par. 22-00.
[8]	Start	Select start for a start/stop command. Logic '1' = start, logic '0' = stop. (Default Digital input 18)
[9]	Latched start	Motor starts, if a pulse is applied for min. 2 ms. Motor stops when Stop inverse is activated
[10]	Reversing	Changes direction of motor shaft rotation. Select Logic '1' to reverse. The reversing signal only changes the direction of rotation. It does not activate the start function. Select both directions in par. 4-10 <i>Motor Speed Direction</i> . (Default Digital input 19).
[11]	Start reversing	Used for start/stop and for reversing on the same wire. Signals on start are not allowed at the same time.
[14]	Jog	Used for activating jog speed. See par. 3-11. (Default Digital input 29)
[15]	Preset reference on	Used for shifting between external reference and preset reference. It is assumed that <i>External/preset</i> [1] has been selected in par. 3-04. Logic '0' = external reference active; logic '1' = one of the eight preset references is active.
[16]	Preset ref bit 0	Enables a choice between one of the eight preset references according to the table below.
[17]	Preset ref bit 1	Enables a choice between one of the eight preset references according to the table below.
[18]	Preset ref bit 2	Enables a choice between one of the eight preset references according to the table below.

Preset ref. bit	2	1	0
Preset ref. 0	0	0	0
Preset ref. 1	0	0	1
Preset ref. 2	0	1	0
Preset ref. 3	0	1	1
Preset ref. 4	1	0	0
Preset ref. 5	1	0	1
Preset ref. 6	1	1	0
Preset ref. 7	1	1	1

[19]	Freeze ref	Freezes actual reference. The frozen reference is now the point of enable/condition for Speed up and Speed down to be used. If Speed up/down is used, the speed change always follows ramp 2 (par. 3-51 and 3-52) in the range 0 - par. 3-03 <i>Maximum Reference</i> .
[20]	Freeze output	Freezes actual motor frequency (Hz). The frozen motor frequency is now the point of enable/condition for Speed up and Speed down to be used. If Speed up/down is used, the speed change always follows ramp 2 (par. 3-51 and 3-52) in the range 0 - par. 1-23 <i>Motor Frequency</i> .
		 <p><b>NB!</b> When Freeze output is active, the frequency converter cannot be stopped via a low 'start [13]' signal. Stop the frequency converter via a terminal programmed for Coasting inverse [2] or Coast and reset, inverse [3].</p>
[21]	Speed up	For digital control of the up/down speed is desired (motor potentiometer). Activate this function by selecting either Freeze reference or Freeze output. When Speed up is activated for less than 400 msec. the resulting reference will be increased by 0.1 %. If Speed up is activated for more than 400 msec. the resulting reference will ramp according to Ramp 1 in par. 3-41.
[22]	Speed down	Same as Speed up [21].
[23]	Set-up select bit 0	Selects one of the four set-ups. Set par. 0-10 <i>Active Set-up</i> to Multi Set-up.
[24]	Set-up select bit 1	Same as Set-up select bit 0 [23]. (Default Digital input 32)
[32]	Pulse input	Select Pulse input when using a pulse sequence as either reference or feedback. Scaling is done in par. group 5-5*.
[34]	Ramp bit 0	Select which ramp to use. Logic "0" will select ramp 1 while logic "1" will select ramp 2.
[36]	Mains failure inverse	Activates par. 14-10 <i>Mains Failure</i> . Mains failure inverse is active in the Logic "0" situation.
[52]	Run Permissive	The input terminal, for which the Run permissive has been programmed must be logic "1" before a start command can be accepted. Run permissive has a logic 'AND' function related to the terminal which is programmed for <i>START</i> [8], <i>Jog</i> [14] or <i>Freeze Output</i> [20], which means that in order to start running the motor, both conditions must be fulfilled. If Run Permissive is programmed on multiple terminals, Run permissive needs only be logic '1' on one of the terminals for the function to be carried out. The digital output signal for Run Request ( <i>Start</i> [8], <i>Jog</i> [14] or <i>Freeze output</i> [20]) programmed in par. 5-3* Digital outputs, or par. 5-4* Relays, will not be affected by Run Permissive.
[53]	Hand start	A signal applied will put the frequency converter into Hand mode as if button <i>Hand On</i> on the LCP has been pressed and a normal stop command will be overridden. If disconnecting the signal, the motor will stop. To make any other start commands valid, another digital input must be assign to <i>Auto Start</i> and a signal applied to this. The <i>Hand On</i> and <i>Auto On</i> buttons on the LCP has no impact. The <i>Off</i> button on the LCP will override <i>Hand Start</i> and <i>Auto Start</i> . Press either the <i>Hand On</i> or <i>Auto On</i> button to make <i>Hand Start</i> and <i>Auto Start</i> active again. If no signal on neither <i>Hand Start</i> nor <i>Auto Start</i> , the motor will stop regardless of any normal Start command applied. If signal applied to both <i>Hand Start</i> and <i>Auto Start</i> , the function will be <i>Auto Start</i> . If pressing the <i>Off</i> button on the LCP the motor will stop regardless of signals on <i>Hand Start</i> and <i>Auto Start</i> .

2

[54]	Auto start	A signal applied will put the frequency converter into Auto mode as if the LCP button <i>Auto On</i> has been pressed. See also <i>Hand Start</i> [53]
[55]	DigiPot Increase	Uses the input as an INCREASE signal to the Digital Potentiometer function described in parameter group 3-9*
[56]	DigiPot Decrease	Uses the input as a DECREASE signal to the Digital Potentiometer function described in parameter group 3-9*
[57]	DigiPot Clear	Uses the input to CLEAR the Digital Potentiometer reference described in parameter group 3-9*
[60]	Counter A (up)	(Terminal 29 or 33 only) Input for increment counting in the SLC counter.
[61]	Counter A (down)	(Terminal 29 or 33 only) Input for decrement counting in the SLC counter.
[62]	Reset Counter A	Input for reset of counter A.
[63]	Counter B (up)	(Terminal 29 and 33 only) Input for increment counting in the SLC counter.
[64]	Counter B (down)	(Terminal 29 and 33 only) Input for decrement counting in the SLC counter.
[65]	Reset Counter B	Input for reset of counter B.
[66]	Sleep Mode	Forces frequency converter into Sleep Mode (see par. 22-4*, Sleep Mode). Reacts on the rising edge of signal applied!
[78]	Reset Preventive Maintenance Word	Resets all data in par. 16-96, Preventive Maintenance Word, to 0.

The below setting options are all related to the Cascade Controller. Wiring diagrams and settings for parameter, see group 25-\*\* for more details.

[120]	Lead Pump Start	Starts/Stops the Lead Pump (controlled by the frequency converter). A start requires that also a System Start signal has been applied e.g. to one of the digital inputs set for <i>Start</i> [8]!
[121]	Lead Pump Alternation	Forces alternation of the lead pump in a Cascade Controller. <i>Lead Pump Alternation</i> , par. 25-50, must be set to either <i>At Command</i> [2] or <i>At Staging or At Command</i> [3]. <i>Alternation Event</i> , par. 25-51, can be set to any of the four options.

[130 - 138] Pump1 Interlock - Pump9 Interlock The function will depend on the setting in par. 25-06, Number of Pumps. If set to *No* [0], then Pump1 refers to the pump controlled by relay RELAY1 etc. If set to *Yes* [1], Pump1 refers to the pump controlled by the frequency converter only (without any of the build in relays involved) and Pump2 to the pump controlled by the relay RELAY1. Variable speed pump (lead) cannot be interlocked in the basic Cascade Controller.  
See below table:

Setting in Par. 5-1*	Setting in Par. 25-06	
	[0] No	[1] Yes
[130] Pump1 Interlock	Controlled by RELAY1 (only if not lead pump)	Frequency Converter controlled (cannot be interlocked)
[131] Pump2 Interlock	Controlled by RELAY2	Controlled by RELAY1
[132] Pump3 Interlock	Controlled by RELAY3	Controlled by RELAY2
[133] Pump4 Interlock	Controlled by RELAY4	Controlled by RELAY3
[134] Pump5 Interlock	Controlled by RELAY5	Controlled by RELAY4
[135] Pump6 Interlock	Controlled by RELAY6	Controlled by RELAY5
[136] Pump7 Interlock	Controlled by RELAY7	Controlled by RELAY6
[137] Pump8 Interlock	Controlled by RELAY8	Controlled by RELAY7
[138] Pump9 Interlock	Controlled by RELAY9	Controlled by RELAY8

5-10 Terminal 18 Digital Input

**Option:** **Function:**

[0]	No operation
[1]	Reset

[2]	Coast inverse	
[3]	Coast and reset inv	
[5]	DC-brake inverse	
[6]	Stop inverse	
[7]	External interlock	
[8] *	Start	Same options and functions as par. 5-1*, except for <i>Pulse input</i> .
[9]	Latched start	
[10]	Reversing	
[11]	Start reversing	
[14]	Jog	
[15]	Preset reference on	
[16]	Preset ref bit 0	
[17]	Preset ref bit 1	
[18]	Preset ref bit 2	
[19]	Freeze reference	
[20]	Freeze output	
[21]	Speed up	
[22]	Speed down	
[23]	Set-up select bit 0	
[24]	Set-up select bit 1	
[34]	Ramp bit 0	
[36]	Mains failure inverse	
[51]	Hand/Auto Start	
[52]	Run permissive	
[53]	Hand start	
[54]	Auto start	
[55]	DigiPot increase	
[56]	DigiPot decrease	
[57]	DigiPot clear	
[62]	Reset Counter A	
[65]	Reset Counter B	
[66]	Sleep Mode	
[78]	Reset Preventive Maintenance Word	
[80]	PTC Card 1	
[120]	Lead Pump Start	
[121]	Lead Pump Alternation	
[130]	Pump 1 Interlock	
[131]	Pump 2 Interlock	
[132]	Pump 3 Interlock	
[133]	Pump 4 Interlock	
[134]	Pump 5 Interlock	
[135]	Pump 6 Interlock	
[136]	Pump 7 Interlock	

[137] Pump 8 Interlock

[138] Pump 9 Interlock

**5-11 Terminal 19 Digital Input****Option:**

[0] \* No operation

**Function:**Same options and functions as 5-1\*, except for *Pulse input*.**Option:****Function:****5-12 Terminal 27 Digital Input****Option:**

[0] \* No operation

**Function:**Same options and functions as par. 5-1\*, except for *Pulse input*.**5-13 Terminal 29 Digital Input****Option:**

[14] \* Jog

**Function:**

Same options and functions as par. 5-1\*.

**5-14 Terminal 32 Digital Input****Option:**

[0] \* No operation

**Function:**Same options and functions as par. 5-1\*, except for *Pulse input*.

[1] Reset

[2] Coast inverse

[3] Coast and reset inv

[5] DC-brake inverse

[6] Stop inverse

[7] External interlock

[8] Start

[9] Latched start

[10] Reversing

[11] Start reversing

[14] Jog

[15] Preset reference on

[16] Preset ref bit 0

[17] Preset ref bit 1

[18] Preset ref bit 2

[19] Freeze reference

[20] Freeze output

[21] Speed up

[22] Speed down

[23] Set-up select bit 0

[24] Set-up select bit 1

[34] Ramp bit 0

[36] Mains failure inverse

[51] Hand/Auto Start

[52]	Run permissive
[53]	Hand start
[54]	Auto start
[55]	DigiPot increase
[56]	DigiPot decrease
[57]	DigiPot clear
[62]	Reset Counter A
[65]	Reset Counter B
[66]	Sleep Mode
[78]	Reset Preventive Maintenance Word
[80]	PTC Card 1
[120]	Lead Pump Start
[121]	Lead Pump Alternation
[130]	Pump 1 Interlock
[131]	Pump 2 Interlock
[132]	Pump 3 Interlock
[133]	Pump 4 Interlock
[134]	Pump 5 Interlock
[135]	Pump 6 Interlock
[136]	Pump 7 Interlock
[137]	Pump 8 Interlock
[138]	Pump 9 Interlock

**5-15 Terminal 33 Digital Input**

<b>Option:</b>	<b>Function:</b>
	Same options and functions as par. 5-1* Digital Inputs.
[0] *	No operation

**5-16 Terminal X30/2 Digital Input**

<b>Option:</b>	<b>Function:</b>
	This parameter is active when option module MCB 101 is installed in the frequency converter. It has the same options and functions as par. 5-1* except for <i>Pulse input</i> [32].
[0] *	No operation

**5-17 Terminal X30/3 Digital Input**

<b>Option:</b>	<b>Function:</b>
	This parameter is active when option module MCB 101 is installed in the frequency converter. It has the same options and functions as par. 5-1* except for <i>Pulse input</i> [32].
[0] *	No operation

**5-18 Terminal X30/4 Digital Input**

<b>Option:</b>	<b>Function:</b>
	This parameter is active when option module MCB 101 is installed in the frequency converter. It has the same options and functions as par. 5-1* except for <i>Pulse input</i> [32].
[0] *	No operation

### 2.7.4 5-3\* Digital Outputs

Parameters for configuring the output functions for the output terminals. The 2 solid-state digital outputs are common for terminals 27 and 29. Set the I/O function for terminal 27 in par. 5-01 *Terminal 27 Mode*, and set the I/O function for terminal 29 in par. 5-02 *Terminal 29 Mode*.

## 2

These parameters cannot be adjusted while the motor is running.

The digital outputs can be programmed with these functions:

[0]	No operation	<i>Default for all digital outputs and relay outputs</i>
[1]	Control ready	The control board receives supply voltage.
[2]	Drive ready	The frequency converter is ready for operation and applies a supply signal on the control board.
[3]	Drive ready / remote control	The frequency converter is ready for operation and is in Auto On mode.
[4]	Stand-by / no warning	The frequency converter is ready for operation. No start or stop command is been given (start/disable). There are no warnings.
[5]	Running	Motor is running.
[6]	Running / no warning	The output speed is higher than the speed set in par. 1-81 <i>Min Speed for Function at Stop [RPM]</i> . The motor is running and there are no warnings.
[8]	Run on reference / no warning	Motor runs at reference speed.
[9]	Alarm	An alarm activates the output. There are no warnings.
[10]	Alarm or warning	An alarm or a warning activates the output.
[11]	At torque limit	The torque limit set in par. 4-16 has been exceeded.
[12]	Out of current range	The motor current is outside the range set in par. 4-18.
[13]	Below current, low	Motor current is lower than set in par. 4-50.
[14]	Above current, high	Motor current is higher than set in par. 4-51.
[15]	Out of speed range	Output speed is outside the range set in par. 4-52 and 4-53.
[16]	Below speed, low	Output speed is lower than the setting in par. 4-52.
[17]	Above speed, high	Output speed is higher than the setting in par. 4-53.
[18]	Out of feedback range	Feedback is outside the range set in par. 4-56 and 4-57.
[19]	Below feedback low	Feedback is below the limit set in par. 4-56 <i>Warning Feedback Low</i> .
[20]	Above feedback high	The feedback is above the limit set in par. 4-57 <i>Warning Feedback High</i> .
[21]	Thermal warning	The thermal warning turns on when the temperature exceeds the limit in the motor, the frequency converter, the brake resistor, or the thermistor.
[25]	Reverse	<i>Reversing. Logic '1' = relay activated, 24 V DC when CW rotation of the motor. Logic '0' = relay not activated, no signal, when CCW rotation of the motor.</i>
[26]	Bus OK	Active communication (no time-out) via the serial communication port.
[27]	Torque limit and stop	Used in performing a coasting stop and in torque limit condition. If the frequency converter has received a stop signal and is at the torque limit, the signal is Logic '0'.
[28]	Brake, no warning	The brake is active and there are no warnings.
[29]	Brake ready, no fault	The brake is ready for operation and there are no faults.
[30]	Brake fault (IGBT)	The output is Logic '1' when the brake IGBT is short-circuited. Use this function to protect the frequency converter if there is a fault on the brake modules. Use the output/relay to cut out the main voltage from the frequency converter.
[35]	External Interlock	External Interlock function has been activated via one of the digital inputs.
[40]	Out of ref range	
[41]	Below reference low	

[42]	Above reference high	
[45]	Bus Ctrl	
[46]	Bus Ctrl 1 if timeout	
[47]	Bus Ctrl 0 if timeout	
[55]	Pulse output	
[60]	Comparator 0	See par. group 13-1*. If Comparator 0 is evaluated as TRUE, the output will go high. Otherwise, it will be low.
[61]	Comparator 1	See par. group 13-1*. If Comparator 2 is evaluated as TRUE, the output will go high. Otherwise, it will be low.
[62]	Comparator 2	See par. group 13-1*. If Comparator 2 is evaluated as TRUE, the output will go high. Otherwise, it will be low.
[63]	Comparator 3	See par. group 13-1*. If Comparator 3 is evaluated as TRUE, the output will go high. Otherwise, it will be low.
[64]	Comparator 4	See par. group 13-1*. If Comparator 4 is evaluated as TRUE, the output will go high. Otherwise, it will be low.
[65]	Comparator 5	See par. group 13-1*. If Comparator 4 is evaluated as TRUE, the output will go high. Otherwise, it will be low.
[70]	Logic Rule 0	See par. group 13-4*. If Logic Rule 0 is evaluated as TRUE, the output will go high. Otherwise, it will be low.
[71]	Logic Rule 1	See par. group 13-4*. If Logic Rule 1 is evaluated as TRUE, the output will go high. Otherwise, it will be low.
[72]	Logic Rule 2	See par. group 13-4*. If Logic Rule 2 is evaluated as TRUE, the output will go high. Otherwise, it will be low.
[73]	Logic Rule 3	See par. group 13-4*. If Logic Rule 3 is evaluated as TRUE, the output will go high. Otherwise, it will be low.
[74]	Logic Rule 4	See par. group 13-4*. If Logic Rule 4 is evaluated as TRUE, the output will go high. Otherwise, it will be low.
[75]	Logic Rule 5	See par. group 13-4*. If Logic Rule 5 is evaluated as TRUE, the output will go high. Otherwise, it will be low.
[80]	SL Digital Output A	See par. 13-52 <i>SL Control Action</i> . The input will go high whenever the Smart Logic Action [38] <i>Set dig. out. A high</i> is executed. The input will go low whenever the Smart Logic Action [32] <i>Set dig. out. A low</i> is executed.
[81]	SL Digital Output B	See par. 13-52 <i>SL Control Action</i> . The input will go high whenever the Smart Logic Action [39] <i>Set dig. out. A high</i> is executed. The input will go low whenever the Smart Logic Action [33] <i>Set dig. out. A low</i> is executed.
[82]	SL Digital Output C	See par. 13-52 <i>SL Control Action</i> . The input will go high whenever the Smart Logic Action [40] <i>Set dig. out. A high</i> is executed. The input will go low whenever the Smart Logic Action [34] <i>Set dig. out. A low</i> is executed.
[83]	SL Digital Output D	See par. 13-52 <i>SL Control Action</i> . The input will go high whenever the Smart Logic Action [41] <i>Set dig. out. A high</i> is executed. The input will go low whenever the Smart Logic Action [35] <i>Set dig. out. A low</i> is executed.
[84]	SL Digital Output E	See par. 13-52 <i>SL Control Action</i> . The input will go high whenever the Smart Logic Action [42] <i>Set dig. out. A high</i> is executed. The input will go low whenever the Smart Logic Action [36] <i>Set dig. out. A low</i> is executed.
[85]	SL Digital Output F	See par. 13-52 <i>SL Control Action</i> . The input will go high whenever the Smart Logic Action [43] <i>Set dig. out. A high</i> is executed. The input will go low whenever the Smart Logic Action [37] <i>Set dig. out. A low</i> is executed.
[160]	No alarm	Output is high when no alarm is present.

2

[161]	Running reverse	The output is high when the frequency converter is running counter clockwise (the logical product of the status bits 'running' AND 'reverse').
[165]	Local reference active	Output is high when par. 3-13 <i>Reference Site</i> = [2] Local or when par. 3-13 <i>Reference Site</i> = [0] <i>Linked to hand auto</i> at the same time as the LCP is in Hand on mode.
[166]	Remote reference active	Output is high when par. 3-13 <i>Reference Site</i> = Remote [1] or <i>Linked to hand/auto</i> [0] while the LCP is in [Auto on] mode.
[167]	Start command active	Output is high when there is an active Start command. (I.e.[Auto On] and a start command via digital input or bus is active, or [Hand On]).
<p><b>NB!</b> All inverse Stop/Coast commands must be inactive.</p>		
[168]	Drive in hand mode	Output is high when the frequency converter is in Hand on mode (as indicated by the LED light above [Hand on]).
[169]	Drive in auto mode	Output is high when the frequency converter is in Hand on mode (as indicated by the LED light above [Auto on]).
[180]	Clock Fault	The clock function has been reset to default (2000-01-01) because of a power failure.
[181]	Preventive Maintenance	One or more of the Preventive Maintenance Events programmed in par. 23-10, Preventive Maintenance Item, has passed the time for the specified action in par. 23-11, Maintenance Action.
[190]	No-Flow	A No-Flow situation or Minimum Speed situation has been detected if enabled in <i>Minimum Speed Detection</i> . par. 22-21 and/or <i>No-Flow Detection</i> , par. 22-22.
[191]	Dry Pump	A Dry Pump condition has been detected. This function must be enabled in par. 22-26, Dry Pump Function.
[192]	End of Curve	Active when an End of Curve condition is present.
[193]	Sleep Mode	The frequency converter/system has turned into sleep mode. See <i>Sleep mode</i> , par. 22-4*.
[194]	Broken Belt	A Broken Belt condition has been detected. This function must be enabled in par. 22-60, Broken Belt Detection.
[195]	Bypass Valve Control	<p>The bypass valve control (Digital / Relay output in the frequency converter) is used for compressor systems to unload the compressor during start-up by using a bypass valve. After the start command is given the bypass valve will be open until the frequency converter reaches <i>Motor speed low limit</i>, par. 4-11) . After the limit has been reached the bypass valve will be closed, allowing the compressor to operate normally. This procedure will not be activated again before a new start is initiated and the frequency converter speed is zero during the receiving of start signal. <i>Start Delay</i>, par. 1-71 can be used in order to delay the motor start. The Bypass valve control principle:</p> <p>The diagram shows a speed profile starting from a minimum speed (Speed Min) and ramping up to a reference speed (REF). The speed then remains constant before ramping down to zero. Digital signals for ON and OFF are shown as pulses that occur during the start and stop phases of the speed profile. The diagram is labeled with '130BA251.10'.</p>

The below setting options are all related to the Cascade Controller.  
Wiring diagrams and settings for parameter, see group 25-\*\* for more details.

[199]	Pipe Filling	Active when the Pipe Fill function is operating. See par. 29-0*.
[200]	Full Capacity	All pumps running and at full speed
[201]	Pump1 Running	One or more of the pumps controlled by the Cascade Controller are running. The function will also depend on the setting of in <i>Fixed Lead Pump</i> , par. 25-06. If set to <i>No</i> [0] Pump 1 refers to the pump controlled by relay RELAY1 etc. If set to <i>Yes</i> [1] Pump 1 refers to the pump controlled by the frequency converter only (without any of the build in relays involved) and Pump 2 to the pump controlled by the relay RELAY1. See below table:
[202]	Pump2 Running	See [201]
[203]	Pump3 Running	See [201]

Setting in Par. 5-3*	Setting in Par. 25-06	
	[0] No	[1] Yes
[200] Pump 1 Running	Controlled by RELAY1	Frequency Converter controlled
[201] Pump 2 Running	Controlled by RELAY2	Controlled by RELAY1
[203] Pump 3 Running	Controlled by RELAY3	Controlled by RELAY2

### 5-30 Terminal 27 Digital Output

**Option:**

**Function:**

Same options and functions as par. 5-3\*.

[0] \* No operation

### 5-31 Terminal 29 Digital Output

**Option:**

**Function:**

Same options and functions as par. 5-3\*.

[0] \* No operation

### 5-32 Term X30/6 Digi Out (MCB 101)

**Option:**

**Function:**

[0] *	No operation	This parameter is active when option module MCB 101 is mounted in the frequency converter.
[1]	Control ready	The control board receives supply voltage.
[2]	Drive ready	The frequency converter is ready for operation and applies a supply signal on the control board.
[3]	Drive rdy/rem ctrl	The frequency converter is ready for operation and is in Auto On mode.
[4]	Stand-by / no warning	Ready for operation. No start or stop command is been given (start/disable). There are no warnings.
[5]	Running	Motor is running.
[6]	Running / no warning	Output speed is higher than the speed set in par. 1-81 <i>Min Speed for Function at Stop [RPM]</i> . The motor is running and there are no warnings.
[8]	Run on ref/no warn	Motor is running within the programmed current and speed ranges set in par. 4-50 <i>Warning Current Low</i> to par. 4-53 <i>Warning Speed High</i> . There are no warnings.
[9]	Alarm	An alarm activates the output. There are no warnings.
[10]	Alarm or warning	An alarm or a warning activates the output.
[11]	At torque limit	The torque limit set in par. 4-16 <i>Torque Limit Motor Mode</i> or par. 1-17 has been exceeded.
[12]	Out of current range	The motor current is outside the range set in par. 4-18 <i>Current Limit</i> .
[13]	Below current, low	Motor current is lower than set in par. 4-50 <i>Warning Current Low</i> .
[14]	Above current, high	Motor current is higher than set in par. 4-51 <i>Warning Current High</i> .

[15]	Out of speed range	Output frequency is outside the frequency range set in par. 4-50 <i>Warning Current Low</i> and par. 4-51 <i>Warning Current High</i> .
[16]	Below speed, low	Output speed is lower than the setting in par. 4-52 <i>Warning Speed Low</i> .
[17]	Above speed, high	Output speed is higher than the setting in par. 4-53 <i>Warning Speed High</i> .
[18]	Out of feedb. range	Feedback is outside the range set in par. 4-56 <i>Warning Feedback Low</i> and par. 4-57 <i>Warning Feedback High</i> .
[19]	Below feedback, low	Feedback is below the limit set in par. 4-56 <i>Warning Feedback Low</i> .
[20]	Above feedback, high	Feedback is above the limit set in par. 4-57 <i>Warning Feedback High</i> .
[21]	Thermal warning	The thermal warning turns on when the temperature exceeds the limit in the motor, the frequency converter, the brake resistor, or the thermistor.
[25]	Reverse	<i>Reversing. Logic '1'</i> when CW rotation of the motor. Logic '0' when CCW rotation of the motor. If the motor is not rotating the output will follow the reference.
[26]	Bus OK	Active communication (no time-out) via the serial communication port.
[27]	Torque limit & stop	Use in performing a coasting stop and in torque limit condition. If the frequency converter has received a stop signal and is at the torque limit, the signal is Logic '0'.
[28]	Brake, no brake war	Brake is active and there are no warnings.
[29]	Brake ready, no fault	Brake is ready for operation and there are no faults.
[30]	Brake fault (IGBT)	Output is Logic '1' when the brake IGBT is short-circuited. Use this function to protect the frequency converter if there is a fault on the brake modules. Use the output/relay to cut out the main voltage from the frequency converter.
[35]	External Interlock	
[40]	Out of ref range	
[41]	Below reference, low	
[42]	Above ref, high	
[45]	Bus ctrl.	Controls output via bus. The state of the output is set in par. 5-90 <i>Digital &amp; Relay Bus Control</i> . The output state is retained in the event of bus time-out.
[46]	Bus ctrl, 1 if timeout	Controls output via bus. The state of the output is set in par. 5-90 <i>Digital &amp; Relay Bus Control</i> . In the event of bus time-out the output state is set high (On).
[47]	Bus ctrl, 0 if timeout	Controls output via bus. The state of the output is set in par. 5-90 <i>Digital &amp; Relay Bus Control</i> . In the event of bus time-out the output state is set low (Off).
[55]	Pulse output	
[60]	Comparator 0	See par. group LC-1#. If Comparator 0 is evaluated as TRUE, the output will go high. Otherwise, it will be low.
[61]	Comparator 1	See par. group LC-1#. If Comparator 1 is evaluated as TRUE, the output will go high. Otherwise, it will be low.
[62]	Comparator 2	See par. group LC-1#. If Comparator 2 is evaluated as TRUE, the output will go high. Otherwise, it will be low.
[63]	Comparator 3	See par. group LC-1#. If Comparator 3 is evaluated as TRUE, the output will go high. Otherwise, it will be low.
[64]	Comparator 4	See par. group LC-1#. If Comparator 4 is evaluated as TRUE, the output will go high. Otherwise, it will be low.

[65]	Comparator 5	See par. group LC-1#. If Comparator 5 is evaluated as TRUE, the output will go high. Otherwise, it will be low.
[70]	Logic rule 0	See par. group LC-4#. If Logic Rule 0 is evaluated as TRUE, the output will go high. Otherwise, it will be low.
[71]	Logic rule 1	See par. group LC-4#. If Logic Rule 1 is evaluated as TRUE, the output will go high. Otherwise, it will be low.
[72]	Logic rule 2	See par. group LC-4#. If Logic Rule 2 is evaluated as TRUE, the output will go high. Otherwise, it will be low.
[73]	Logic rule 3	See par. group LC-4#. If Logic Rule 3 is evaluated as TRUE, the output will go high. Otherwise, it will be low.
[74]	Logic rule 4	See par. group LC-4#. If Logic Rule 4 is evaluated as TRUE, the output will go high. Otherwise, it will be low.
[75]	Logic rule 5	See par. group LC-4#. If Logic Rule 5 is evaluated as TRUE, the output will go high. Otherwise, it will be low.
[80]	SL digital output A	See par. 13-52 <i>SL Controller Action</i> . The output will go high whenever the Logic Action [38] <i>Set dig. out. A high</i> is executed. The output will go low whenever the Logic Action [32] <i>Set dig. out. A low</i> is executed.
[81]	SL digital output B	See par. 13-52 <i>SL Controller Action</i> . The input will go high whenever the Logic Action [39] <i>Set dig. out. A high</i> is executed. The input will go low whenever the Logic Action [33] <i>Set dig. out. A low</i> is executed.
[82]	SL digital output C	See par. 13-52 <i>SL Controller Action</i> . The input will go high whenever the Logic Action [40] <i>Set dig. out. A high</i> is executed. The input will go low whenever the Logic Action [34] <i>Set dig. out. A low</i> is executed.
[83]	SL digital output D	See par. 13-52 <i>SL Controller Action</i> . The input will go high whenever the Logic Action [41] <i>Set dig. out. A high</i> is executed. The input will go low whenever the Logic Action [35] <i>Set dig. out. A low</i> is executed.
[84]	SL digital output E	See par. 13-52 <i>SL Controller Action</i> . The input will go high whenever the Logic Action [42] <i>Set dig. out. A high</i> is executed. The input will go low whenever the Logic Action [36] <i>Set dig. out. A low</i> is executed.
[85]	SL digital output F	See par. 13-52 <i>SL Controller Action</i> . The input will go high whenever the Logic Action [43] <i>Set dig. out. A high</i> is executed. The input will go low whenever the Logic Action [37] <i>Set dig. out. A low</i> is executed.
[160]	No alarm	Output is high when no alarm is present.
[161]	Running reverse	Output is high when the frequency converter is running counter clockwise (the logical product of the status bits 'running' AND 'reverse').
[165]	Local ref active	Output is high when par. 3-13 <i>Reference Site</i> = [2] Local or when par. 3-13 <i>Reference Site</i> = [0] <i>Linked to hand auto</i> at the same time as the LCP is in Hand mode.
[166]	Remote ref active	Output is high when par. 3-13 <i>Reference Site</i> = Remote [1] or <i>Linked to hand/auto</i> [0] while the LCP is in [Auto] mode.
[167]	Start command act.	Output is high when there is an active Start command (i.e. via digital input bus connection or [Hand] or [Auto]), and no Stop or Start command is active.
[168]	Hand mode	Output is high when the frequency converter is in Hand mode (as indicated by the LED light above [Hand]).

[169]	Auto mode	Output is high when the frequency converter is in Hand on mode (as indicated by the LED light above [Auto]).
[180]	Clock Fault	
[181]	Prev. Maintenance	
[188]	AHF Capacitor Connect	
[189]	External Fan Control	
[190]	No-Flow	
[191]	Dry Pump	
[192]	End Of Curve	
[193]	Sleep Mode	
[194]	Broken Belt	
[195]	Bypass Valve Control	
[198]	Drive Bypass	
[199]	Pipe Filling	
[200]	Full capacity	
[201]	Pump 1 running	
[202]	Pump 2 running	
[203]	Pump 3 running	
[204]	Pump 4 running	
[205]	Pump 5 running	
[206]	Pump 6 running	
[207]	Pump 7 running	
[208]	Pump 8 running	
[209]	Pump 9 running	

### 5-33 Term X30/7 Digi Out (MCB 101)

Option:	Function:
[0] * No operation	This parameter is active when option module MCB 101 is mounted in the frequency converter.
[1] Control ready	The control board receives supply voltage.
[2] Drive ready	The frequency converter is ready for operation and applies a supply signal on the control board.
[3] Drive rdy/rem ctrl	The frequency converter is ready for operation and is in Auto mode.
[4] Stand-by / no warning	Ready for operation. No start or stop command is been given (start/disable). There are no warnings.
[5] Running	Motor is running.
[6] Running / no warning	Output speed is higher than the speed set in par. 1-81 <i>Min Speed for Function at Stop [RPM]</i> . The motor is running and there are no warnings.
[8] Run on ref/no warn	Motor runs at reference speed.
[9] Alarm	An alarm activates the output. There are no warnings.
[10] Alarm or warning	An alarm or a warning activates the output.
[11] At torque limit	The torque limit set in par. 4-16 <i>Torque Limit Motor Mode</i> or par. 1-17 has been exceeded.
[12] Out of current range	The motor current is outside the range set in par. 4-18 <i>Current Limit</i> .
[13] Below current, low	Motor current is lower than set in par. 4-50 <i>Warning Current Low</i> .

[14]	Above current, high	Motor current is higher than set in par. 4-51 <i>Warning Current High</i> .
[15]	Out of speed range	Output frequency is outside the frequency range set in par. 4-50 <i>Warning Current Low</i> and par. 4-51 <i>Warning Current High</i> .
[16]	Below speed, low	Output speed is lower than the setting in par. 4-52 <i>Warning Speed Low</i> .
[17]	Above speed, high	Output speed is higher than the setting in par. 4-53 <i>Warning Speed High</i> .
[18]	Out of feedb. range	Feedback is outside the range set in par. 4-56 <i>Warning Feedback Low</i> and par. 4-57 <i>Warning Feedback High</i> .
[19]	Below feedback, low	Feedback is below the limit set in par. 4-56 <i>Warning Feedback Low</i> .
[20]	Above feedback, high	Feedback is above the limit set in par. 4-57 <i>Warning Feedback High</i> .
[21]	Thermal warning	The thermal warning turns on when the temperature exceeds the limit in the motor, the frequency converter, the brake resistor, or the thermistor.
[25]	Reverse	<i>Reversing</i> . Logic '1' when CW rotation of the motor. Logic '0' when CCW rotation of the motor. If the motor is not rotating the output will follow the reference.
[26]	Bus OK	Active communication (no time-out) via the serial communication port.
[27]	Torque limit & stop	Use in performing a coasting stop and in torque limit condition. If the frequency converter has received a stop signal and is at the torque limit, the signal is Logic '0'.
[28]	Brake, no brake war	Brake is active and there are no warnings.
[29]	Brake ready, no fault	Brake is ready for operation and there are no faults.
[30]	Brake fault (IGBT)	Output is Logic '1' when the brake IGBT is short-circuited. Use this function to protect the frequency converter if there is a fault on the brake modules. Use the output/relay to cut out the main voltage from the frequency converter.
[35]	External Interlock	
[40]	Out of ref range	
[41]	Below reference, low	
[42]	Above ref, high	
[45]	Bus ctrl.	Controls output via bus. The state of the output is set in par. 5-90 <i>Digital &amp; Relay Bus Control</i> . The output state is retained in the event of bus time-out.
[46]	Bus ctrl, 1 if timeout	Controls output via bus. The state of the output is set in par. 5-90 <i>Digital &amp; Relay Bus Control</i> . In the event of bus time-out the output state is set high (On).
[47]	Bus ctrl, 0 if timeout	Controls output via bus. The state of the output is set in par. 5-90 <i>Digital &amp; Relay Bus Control</i> . In the event of bus time-out the output state is set low (Off).
[60]	Comparator 0	See par. group LC-1#. If Comparator 0 is evaluated as TRUE, the output will go high. Otherwise, it will be low.
[61]	Comparator 1	See par. group LC-1#. If Comparator 1 is evaluated as TRUE, the output will go high. Otherwise, it will be low.
[62]	Comparator 2	See par. group LC-1#. If Comparator 2 is evaluated as TRUE, the output will go high. Otherwise, it will be low.
[63]	Comparator 3	See par. group LC-1#. If Comparator 3 is evaluated as TRUE, the output will go high. Otherwise, it will be low.
[64]	Comparator 4	See par. group LC-1#. If Comparator 4 is evaluated as TRUE, the output will go high. Otherwise, it will be low.

[65]	Comparator 5	See par. group LC-1#. If Comparator 5 is evaluated as TRUE, the output will go high. Otherwise, it will be low.
[70]	Logic rule 0	See par. group LC-4#. If Logic Rule 0 is evaluated as TRUE, the output will go high. Otherwise, it will be low.
[71]	Logic rule 1	See par. group LC-4#. If Logic Rule 1 is evaluated as TRUE, the output will go high. Otherwise, it will be low.
[72]	Logic rule 2	See par. group LC-4#. If Logic Rule 2 is evaluated as TRUE, the output will go high. Otherwise, it will be low.
[73]	Logic rule 3	See par. group LC-4#. If Logic Rule 3 is evaluated as TRUE, the output will go high. Otherwise, it will be low.
[74]	Logic rule 4	See par. group LC-4#. If Logic Rule 4 is evaluated as TRUE, the output will go high. Otherwise, it will be low.
[75]	Logic rule 5	See par. group LC-4#. If Logic Rule 5 is evaluated as TRUE, the output will go high. Otherwise, it will be low.
[80]	SL digital output A	See par. 13-52 <i>SL Controller Action</i> . The output will go high whenever the Logic Action [38] <i>Set dig. out. A high</i> is executed. The output will go low whenever the Logic Action [32] <i>Set dig. out. A low</i> is executed.
[81]	SL digital output B	See par. 13-52 <i>SL Controller Action</i> . The input will go high whenever the Logic Action [39] <i>Set dig. out. A high</i> is executed. The input will go low whenever the Logic Action [33] <i>Set dig. out. A low</i> is executed.
[82]	SL digital output C	See par. 13-52 <i>SL Controller Action</i> . The input will go high whenever the Logic Action [40] <i>Set dig. out. A high</i> is executed. The input will go low whenever the Logic Action [34] <i>Set dig. out. A low</i> is executed.
[83]	SL digital output D	See par. 13-52 <i>SL Controller Action</i> . The input will go high whenever the Logic Action [41] <i>Set dig. out. A high</i> is executed. The input will go low whenever the Logic Action [35] <i>Set dig. out. A low</i> is executed.
[84]	SL digital output E	See par. 13-52 <i>SL Controller Action</i> . The input will go high whenever the Logic Action [42] <i>Set dig. out. A high</i> is executed. The input will go low whenever the Logic Action [36] <i>Set dig. out. A low</i> is executed.
[85]	SL digital output F	See par. 13-52 <i>SL Controller Action</i> . The input will go high whenever the Logic Action [43] <i>Set dig. out. A high</i> is executed. The input will go low whenever the Logic Action [37] <i>Set dig. out. A low</i> is executed.
[160]	No alarm	Output is high when no alarm is present.
[161]	Running reverse	Output is high when the frequency converter is running counter clockwise (the logical product of the status bits 'running' AND 'reverse').
[165]	Local ref active	Output is high when par. 3-13 <i>Reference Site</i> = [2] Local or when par. 3-13 <i>Reference Site</i> = [0] <i>Linked to hand auto</i> at the same time as the LCP is in Hand mode.
[166]	Remote ref active	Output is high when par. 3-13 <i>Reference Site</i> = Remote [1] or <i>Linked to hand/auto</i> [0] while the LCP is in [Auto] mode.
[167]	Start command act.	Output is high when there is an active Start command (i.e. via digital input bus connection or [Hand] or [Auto]), and no Stop or Start command is active.
[168]	Hand mode	Output is high when the frequency converter is in Hand mode (as indicated by the LED light above [Hand]).

[169]	Auto mode	Output is high when the frequency converter is in Auto mode (as indicated by the LED light above [Auto]).
[180]	Clock Fault	
[181]	Prev. Maintenance	
[188]	AHF Capacitor Connect	
[189]	External Fan Control	
[190]	No-Flow	
[191]	Dry Pump	
[192]	End Of Curve	
[193]	Sleep Mode	
[194]	Broken Belt	
[195]	Bypass Valve Control	
[200]	Full capacity	
[201]	Pump 1 running	
[202]	Pump 2 running	
[203]	Pump 3 running	
[204]	Pump 4 running	
[205]	Pump 5 running	
[206]	Pump 6 running	
[207]	Pump 7 running	
[208]	Pump 8 running	
[209]	Pump 9 running	

### 2.7.5 5-4\* Relays

Parameters for configuring the timing and the output functions for the relays.

#### 5-40 Function Relay

Array [8]

(Relay 1 [0], Relay 2 [1], Relay 7 [6], Relay 8 [7], Relay 9 [8])

Select options to define the function of the relays.

The selection of each mechanical relay is realized in an array parameter.

[0] *	No Operation
[1]	Control Ready
[2]	Drive Ready
[3]	Drive Ready/Remote
[4]	Stand-by/No Warning
[5]	Running
[6]	Running/No Warning
[8]	Run on Ref./No Warning
[9]	Alarm
[10]	Alarm or Warning
[11]	At Torque Limit

## 2

[12]	Out of Current Range
[13]	Below Current, low
[14]	Above Current, high
[15]	Out of Speed Range
[16]	Below Speed, low
[17]	Above Speed, high
[18]	Out of Feedb. Range
[19]	Below Feedback, low
[20]	Above Feedback, high
[21]	Thermal Warning
[25]	Reverse
[26]	Bus OK
[27]	Torque Limit & Stop
[28]	Brake, No Warning
[29]	Brake Ready, No Fault
[30]	Brake Fault (IGBT)
[35]	External Interlock
[36]	Control Word Bit 11
[37]	Control Word Bit 12
[40]	Out of Ref. Range
[41]	Below Reference, low
[42]	Above Ref. high
[45]	Bus ctrl
[46]	Bus ctrl, 1 if timeout
[47]	Bus ctrl, 0 if timeout
[60]	Comparator 0
[61]	Comparator 1
[62]	Comparator 2
[63]	Comparator 3
[64]	Comparator 4
[65]	Comparator 5
[70]	Logic Rule 0
[71]	Logic Rule 1
[72]	Logic Rule 2
[73]	Logic Rule 3
[74]	Logic Rule 4
[75]	Logic Rule 5
[80]	SL Digital Output A
[81]	SL Digital Output B
[82]	SL Digital Output C
[83]	SL Digital Output D
[84]	SL Digital Output E
[85]	SL Digital Output F

[160]	No Alarm
[161]	Running Reverse
[165]	Local Ref. Active
[166]	Remote Ref. Active
[167]	Start Cmd. Active
[168]	Drive in Hand Mode
[169]	Drive in Auto Mode
[180]	Clock Fault
[181]	Prev. Maintenance
[190]	No-Flow
[191]	Dry Pump
[192]	End of Curve
[193]	Sleep Mode
[194]	Broken Belt
[195]	Bypass Valve Control
[199]	Pipe Filling
[211]	Cascade Pump1
[212]	Cascade Pump2
[213]	Cascade Pump3
[223]	Alarm, Trip Locked
[224]	Bypass Mode Active

2

2

**5-41 On Delay, Relay**

Array [8](Relay 1 [0], Relay 2 [1], Relay 3 [2], Relay 4 [3], Relay 5 [4], Relay 6 [5], Relay 7 [6], Relay 8 [7], Relay 9 [8])

**Range:**

0.01 s\* [0.01 - 600.00 s]

**Function:**

Enter the delay of the relay cut-in time. Select one of available mechanical relays and MCO 105 in an array function. See par. 5-40 *Function Relay*. Relay 3-6 are included in MCB 112 (ATEX).

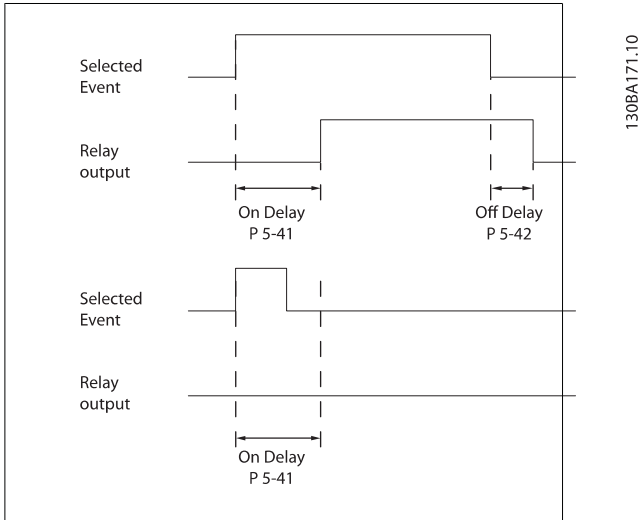

**5-42 Off Delay, Relay**

Array [8] (Relay 1 [0], Relay 2 [1], Relay 3 [2], Relay 4 [3], Relay 5 [4], Relay 6 [5], Relay 7 [6], Relay 8 [7], Relay 9 [8])

**Range:**

0.01 s\* [0.01 - 600.00 s]

**Function:**

Enter the delay of the relay cut-out time. Select one of available mechanical relays and MCO 105 in an array function. See par. 5-40 *Function Relay*.

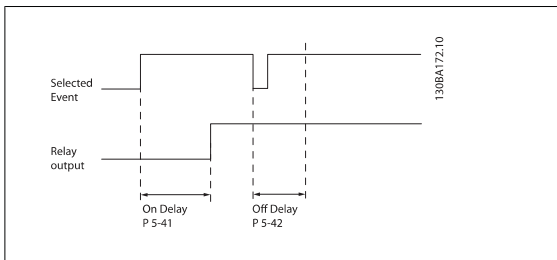

If the selected Event condition changes before the on- or off delay timer expires, the relay output is unaffected.

### 2.7.6 5-5\* Pulse Input

The pulse input parameters are used to define an appropriate window for the impulse reference area by configuring the scaling and filter settings for the pulse inputs. Input terminals 29 or 33 act as frequency reference inputs. Set terminal 29 (par. 5-13 *Terminal 29 Digital Input*) or terminal 33 (par. 5-15 *Terminal 33 Digital Input*) to *Pulse input* [32]. If terminal 29 is used as an input, then set par. 5-02 *Terminal 29 Mode* to *Input* [0].



5-50 Term. 29 Low Frequency		
<b>Range:</b>		<b>Function:</b>
100 Hz* [0 - 110000 Hz]		Enter the low frequency limit corresponding to the low motor shaft speed (i.e. low reference value) in par. 5-52 <i>Term. 29 Low Ref./Feedb. Value</i> . Refer to the diagram in this section.
5-51 Term. 29 High Frequency		
<b>Range:</b>		<b>Function:</b>
100 Hz* [0 - 110000 Hz]		Enter the high frequency limit corresponding to the high motor shaft speed (i.e. high reference value) in par. 5-53 <i>Term. 29 High Ref./Feedb. Value</i> .
5-52 Term. 29 Low Ref./Feedb. Value		
<b>Range:</b>		<b>Function:</b>
0.000* [-999999.999 - 999999.999 ]		Enter the low reference value limit for the motor shaft speed [RPM]. This is also the lowest feedback value, see also par. 5-57 <i>Term. 33 Low Ref./Feedb. Value</i> .
5-53 Term. 29 High Ref./Feedb. Value		
<b>Range:</b>		<b>Function:</b>
100.000* [-999999.999 - 999999.999 ]		Enter the high reference value [RPM] for the motor shaft speed and the high feedback value, see also par. 5-58 <i>Term. 33 High Ref./Feedb. Value</i> .
5-54 Pulse Filter Time Constant #29		
<b>Range:</b>		<b>Function:</b>
100 ms* [1 - 1000 ms]		Enter the pulse filter time constant. The pulse filter dampens oscillations of the feedback signal, which is an advantage if there is a lot of noise in the system. A high time constant value results in better dampening but also increases the time delay through the filter. This parameter cannot be adjusted while the motor is running.
5-55 Term. 33 Low Frequency		
<b>Range:</b>		<b>Function:</b>
100 Hz* [0 - 110000 Hz]		Enter the low frequency corresponding to the low motor shaft speed (i.e. low reference value) in par. 5-57 <i>Term. 33 Low Ref./Feedb. Value</i> .
5-56 Term. 33 High Frequency		
<b>Range:</b>		<b>Function:</b>
100 Hz* [0 - 110000 Hz]		Enter the high frequency corresponding to the high motor shaft speed (i.e. high reference value) in par. 5-58 <i>Term. 33 High Ref./Feedb. Value</i> .

**2**

**5-57 Term. 33 Low Ref./Feedb. Value**

Range:	Function:
0.000* [-999999.999 - 999999.999 ]	Enter the low reference value [RPM] for the motor shaft speed. This is also the low feedback value, see also par. 5-52 <i>Term. 29 Low Ref./Feedb. Value.</i>

**5-58 Term. 33 High Ref./Feedb. Value**

Range:	Function:
100.000* [-999999.999 - 999999.999 ]	Enter the high reference value [RPM] for the motor shaft speed. See also par. 5-53 <i>Term. 29 High Ref./Feedb. Value.</i>

**5-59 Pulse Filter Time Constant #33**

Range:	Function:
100 ms* [1 - 1000 ms]	Enter the pulse filter time constant. The low-pass filter reduces the influence on and dampens oscillations on the feedback signal from the control.  This is an advantage, e.g. if there is a great amount on noise in the system. This parameter cannot be adjusted while the motor is running.

**2.7.7 5-6\* Pulse Outputs**

Parameters for configuring the scaling and output functions of pulse outputs. The pulse outputs are designated to terminals 27 or 29. Select terminal 27 output in par. 5-01 and terminal 29 output in par. 5-02.

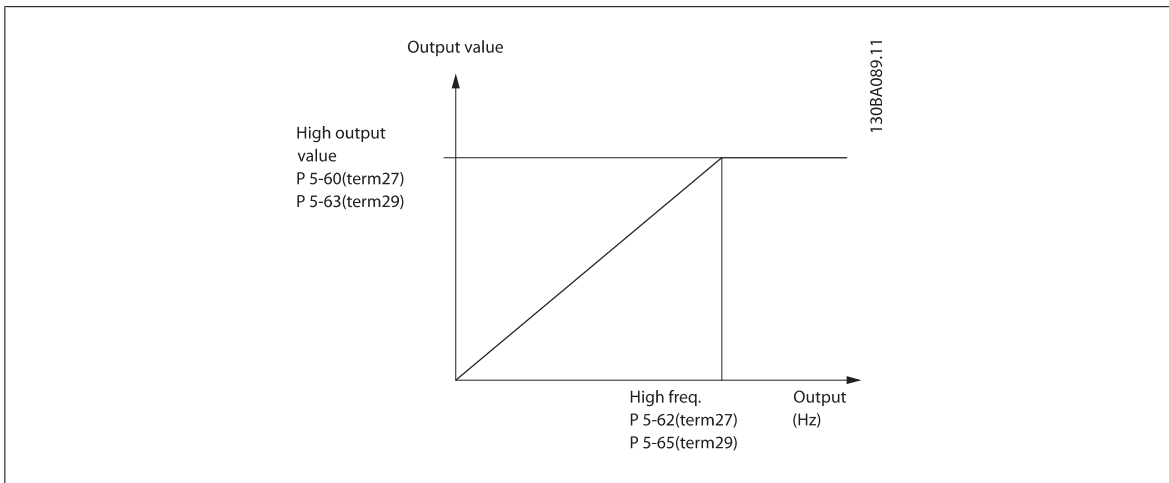

Options for readout output variables:

[0] *	No operation
[45]	Bus ctrl.
[48]	Bus ctrl., timeout
[100]	Output frequency
[101]	Reference
[102]	Feedback
[103]	Motor current

[104]	Torque relative to limit
[105]	Torque relative to rated
[106]	Power
[107]	Speed
[108]	Torque
[113]	Ext. Closed Loop 1
[114]	Ext. Closed Loop 2
[115]	Ext. Closed Loop 3

**5-60 Terminal 27 Pulse Output Variable**

<b>Option:</b>	<b>Function:</b>
[0] * No operation	Same options and functions as par. 5-6*.  Select the operation variable assigned for terminal 27 readouts. This parameter cannot be adjusted while the motor is running.
[45]	Bus ctrl.
[48]	Bus ctrl., timeout
[100]	Output freq. 0-100
[101]	Reference Min-Max
[102]	Feedback +-200%
[103]	Motor cur. 0-Imax
[104]	Torque 0-Tlim
[105]	Torque 0-Tnom
[106]	Power 0-Pnom
[107]	Speed 0-HighLim
[108]	Torque +-160%
[109]	Out frq 0-Fmax
[113]	Ext. Closed Loop 1
[114]	Ext. Closed Loop 2
[115]	Ext. Closed Loop 3
[116]	Cascade Reference

**5-62 Pulse Output Max Freq #27**

<b>Range:</b>	<b>Function:</b>
5000 Hz* [0 - 32000 Hz]	Set the maximum frequency for terminal 27, corresponding to the output variable selected in par. 5-60 <i>Terminal 27 Pulse Output Variable</i> . This parameter cannot be adjusted while the motor is running.

**5-63 Terminal 29 Pulse Output Variable****Option:****Function:**

[0] *	No operation	Select the variable for viewing on the terminal 29 display. This parameter cannot be adjusted while the motor is running.
[45]	Bus ctrl.	
[48]	Bus ctrl., timeout	
[100]	Output freq. 0-100	
[101]	Reference Min-Max	
[102]	Feedback +-200%	
[103]	Motor cur. 0-Imax	
[104]	Torque 0-Tlim	
[105]	Torque 0-Tnom	
[106]	Power 0-Pnom	
[107]	Speed 0-HighLim	
[108]	Torque +-160%	
[109]	Out frq 0-Fmax	
[113]	Ext. Closed Loop 1	
[114]	Ext. Closed Loop 2	
[115]	Ext. Closed Loop 3	
[116]	Cascade Reference	

**5-65 Pulse Output Max Freq #29****Range:****Function:**

5000 Hz*	[0 - 32000 Hz]	Set the maximum frequency for terminal 29 corresponding to the output variable set in par. 5-63 <i>Terminal 29 Pulse Output Variable</i> . This parameter cannot be adjusted while the motor is running.
----------	----------------	---

**5-66 Terminal X30/6 Pulse Output Variable**

Option:	Function:
[0] * No operation	Select the variable for read-out on terminal X30/6. This parameter cannot be adjusted while the motor is running. This parameter is active when option module MCB 101 is installed in the frequency converter.
[45] Bus ctrl.	
[48] Bus ctrl., timeout	
[100] Output freq. 0-100	
[101] Reference Min-Max	
[102] Feedback +-200%	
[103] Motor cur. 0-I <sub>max</sub>	
[104] Torque 0-T <sub>lim</sub>	
[105] Torque 0-T <sub>nom</sub>	
[106] Power 0-P <sub>nom</sub>	
[107] Speed 0-HighLim	
[108] Torque +-160%	
[109] Out frq 0-F <sub>max</sub>	
[113] Ext. Closed Loop 1	
[114] Ext. Closed Loop 2	
[115] Ext. Closed Loop 3	
[116] Cascade Reference	

**5-68 Pulse Output Max Freq #X30/6**

Range:	Function:
5000 Hz* [0 - 32000 Hz]	Select the maximum frequency on terminal X30/6 referring to the output variable in par. 5-66 <i>Terminal X30/6 Pulse Output Variable</i> . This parameter cannot be adjusted while the motor is running. This parameter is active when option module MCB 101 is mounted in the frequency converter.

**2.7.8 5-9\*Bus Controlled**

This parameter group selects digital and relay outputs via a fieldbus setting.

**5-90 Digital & Relay Bus Control**

Range:	Function:
0* [0 - 2147483647 ]	This parameter holds the state of the digital outputs and relays that is controlled by bus. A logical '1' indicates that the output is high or active. A logical '0' indicates that the output is low or inactive.

Bit 0	CC Digital Output Terminal 27
Bit 1	CC Digital Output Terminal 29
Bit 2	GPIO Digital Output Terminal X 30/6
Bit 3	GPIO Digital Output Terminal X 30/7
Bit 4	CC Relay 1 output terminal
Bit 5	CC Relay 2 output terminal
Bit 6	Option B Relay 1 output terminal
Bit 7	Option B Relay 2 output terminal
Bit 8	Option B Relay 3 output terminal
Bit 9-15	Reserved for future terminals
Bit 16	Option C Relay 1 output terminal
Bit 17	Option C Relay 2 output terminal
Bit 18	Option C Relay 3 output terminal
Bit 19	Option C Relay 4 output terminal
Bit 20	Option C Relay 5 output terminal
Bit 21	Option C Relay 6 output terminal
Bit 22	Option C Relay 7 output terminal
Bit 23	Option C Relay 8 output terminal
Bit 24-31	Reserved for future terminals

**5-93 Pulse Out #27 Bus Control****Range:**

0.00 %\* [0.00 - 100.00 %]

**Function:**

Contains the frequency to apply to the digital output terminal 27, when it is configured as [Bus Controlled].

**5-94 Pulse Out #27 Timeout Preset****Range:**

0.00 %\* [0.00 - 100.00 %]

**Function:**

Contains the frequency to apply to the digital output terminal 27, when it is configured as [Bus Controlled Timeout] and timeout is detected.

**5-95 Pulse Out #29 Bus Control****Range:**

0.00 %\* [0.00 - 100.00 %]

**Function:**

Contains the frequency to apply to the digital output terminal 29, when it is configured as [Bus Controlled].

**5-96 Pulse Out #29 Timeout Preset****Range:**

0.00 %\* [0.00 - 100.00 %]

**Function:**

Contains the frequency to apply to the digital output terminal 29, when it is configured as [Bus Controlled Timeout] and timeout is detected

**5-97 Pulse Out #X30/6 Bus Control****Range:**

0.00 %\* [0.00 - 100.00 %]

**Function:**

Contains the frequency to apply to the digital output terminal 27, when it is configured as [Bus Controlled].

**5-98 Pulse Out #X30/6 Timeout Preset****Range:**

0.00 %\* [0.00 - 100.00 %]

**Function:**

Contains the frequency to apply to the digital output terminal 6, when it is configured as [Bus Controlled Timeout] and time-out is detected.

## 2.7 Main Menu - Analog In/Out - Group 6

### 2.8.1 6-\*\*- Analog In/Out

Parameter group for configuration of the analog input and output.

### 2.8.2 6-0\* Analog I/O Mode

Parameter group for setting up the analog I/O configuration.

The frequency converter is equipped with 2 analog inputs: Terminal 53 and 54. The analog inputs can freely be allocated to either voltage (0 - 10 V) or current input (0/4 - 20 mA)

	<b>NB!</b> Thermistors may be connected to either an analog or a digital input.
---	--

### 6-00 Live Zero Timeout Time

Range:	Function:
10 s* [1 - 99 s]	Enter the Live Zero Time-out time period. Live Zero Time-out Time is active for analog inputs, i.e. terminal 53 or terminal 54, used as reference or feedback sources. If the reference signal value associated with the selected current input falls below 50% of the value set in par. 6-10 <i>Terminal 53 Low Voltage</i> , par. 6-12 <i>Terminal 53 Low Current</i> , par. 6-20 <i>Terminal 54 Low Voltage</i> or par. 6-22 <i>Terminal 54 Low Current</i> for a time period longer than the time set in par. 6-00 <i>Live Zero Timeout Time</i> , the function selected in par. 6-01 <i>Live Zero Timeout Function</i> will be activated.

2

**6-01 Live Zero Timeout Function**

**Option:**

**Function:**

Select the time-out function. The function set in par. 6-01 *Live Zero Timeout Function* will be activated if the input signal on terminal 53 or 54 is below 50% of the value in par. 6-10 *Terminal 53 Low Voltage*, par. 6-12 *Terminal 53 Low Current*, par. 6-20 *Terminal 54 Low Voltage* or par. 6-22 *Terminal 54 Low Current* for a time period defined in par. 6-00 *Live Zero Timeout Time*. If several time-outs occur simultaneously, the frequency converter prioritises the time-out functions as follows:

1. par. 6-01 *Live Zero Timeout Function*
2. par. 8-04 *Control Timeout Function*

The output frequency of the frequency converter can be:

- [1] frozen at the present value
- [2] overruled to stop
- [3] overruled to jog speed
- [4] overruled to max. speed
- [5] overruled to stop with subsequent trip

[0] \* Off

[1] Freeze output

[2] Stop

[3] Jogging

[4] Max. speed

[5] Stop and trip

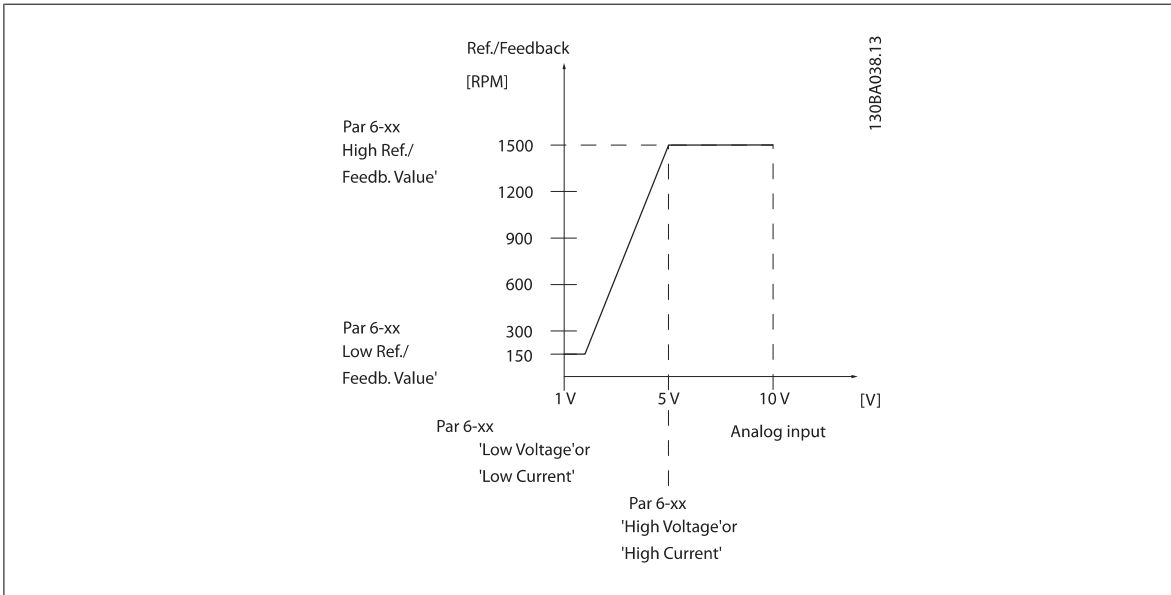

**6-02 Fire Mode Live Zero Timeout Function**

Option:	Function:
	The function set in par. 6-01 <i>Live Zero Timeout Function</i> will be activated if the input signal on analogue inputs is below 50% of the value defined in parameter group 6-1* to 6-6* "Terminal xx Low Current" or "Terminal xx Low Voltage" for a time period defined in par. 6-00 <i>Live Zero Timeout Time</i> .
[0] * Off	
[1] Freeze output	
[2] Stop	
[3] Jogging	
[4] Max. speed	

**2.8.3 6-1\* Analog Input 1**

Parameters for configuring the scaling and limits for analog input 1 (terminal 53).

**6-10 Terminal 53 Low Voltage**

Range:	Function:
0.07 V* [Application dependant]	Enter the low voltage value. This analog input scaling value should correspond to the low reference/feedback value set in par. 6-14 <i>Terminal 53 Low Ref./Feedb. Value</i> .

**6-11 Terminal 53 High Voltage**

Range:	Function:
10.00 V* [Application dependant]	Enter the high voltage value. This analog input scaling value should correspond to the high reference/feedback value set in par. 6-15 <i>Terminal 53 High Ref./Feedb. Value</i> .

**6-12 Terminal 53 Low Current**

Range:	Function:
4.00 mA* [Application dependant]	Enter the low current value. This reference signal should correspond to the low reference/feedback value, set in par. 6-14 <i>Terminal 53 Low Ref./Feedb. Value</i> . The value must be set at >2 mA in order to activate the Live Zero Time-out Function in par. 6-01 <i>Live Zero Timeout Function</i> .

**6-13 Terminal 53 High Current**

Range:	Function:
20.00 mA* [Application dependant]	Enter the high current value corresponding to the high reference/feedback set in par. 6-15 <i>Terminal 53 High Ref./Feedb. Value</i> .

**6-14 Terminal 53 Low Ref./Feedb. Value**

Range:	Function:
0.000* [-999999.999 - 999999.999 ]	Enter the analog input scaling value that corresponds to the low voltage/low current set in par. 6-10 <i>Terminal 53 Low Voltage</i> and par. 6-12 <i>Terminal 53 Low Current</i> .

**6-15 Terminal 53 High Ref./Feedb. Value**

Range:	Function:
Application dependant* [-999999.999 - 999999.999 ]	Enter the analog input scaling value that corresponds to the high voltage/high current value set in par. 6-11 <i>Terminal 53 High Voltage</i> and par. 6-13 <i>Terminal 53 High Current</i> .

**6-16 Terminal 53 Filter Time Constant****Range:**

0.001 s\* [0.001 - 10.000 s]

**Function:**

Enter the time constant. This is a first-order digital low pass filter time constant for suppressing electrical noise in terminal 53. A high time constant value improves dampening but also increases the time delay through the filter.

This parameter cannot be adjusted while the motor is running.

**6-17 Terminal 53 Live Zero****Option:**

[0] Disabled

[1] \* Enabled

**Function:**

This parameter makes it possible to disable the Live Zero monitoring. E.g. to be used if the analog outputs are used as part of a decentral I/O system (e.g. when not part of any frequency converter related control functions, but feeding an external control system with data)

**2.8.4 6-2\* Analog Input 2**

Parameters for configuring the scaling and limits for analog input 2 (terminal 54).

**6-20 Terminal 54 Low Voltage****Range:**

0.07 V\* [Application dependant]

**Function:**

Enter the low voltage value. This analog input scaling value should correspond to the low reference/feedback value, set in par. 6-24 *Terminal 54 Low Ref./Feedb. Value*.

**6-21 Terminal 54 High Voltage****Range:**

10.00 V\* [Application dependant]

**Function:**

Enter the high voltage value. This analog input scaling value should correspond to the high reference/feedback value set in par. 6-25 *Terminal 54 High Ref./Feedb. Value*.

**6-22 Terminal 54 Low Current****Range:**

4.00 mA\* [Application dependant]

**Function:**

Enter the low current value. This reference signal should correspond to the low reference/feedback value, set in par. 6-24 *Terminal 54 Low Ref./Feedb. Value*. The value must be set at >2 mA in order to activate the Live Zero Time-out Function in par. 6-01 *Live Zero Timeout Function*.

**6-23 Terminal 54 High Current****Range:**

20.00 mA\* [Application dependant]

**Function:**

Enter the high current value corresponding to the high reference/feedback value set in par. 6-25 *Terminal 54 High Ref./Feedb. Value*.

**6-24 Terminal 54 Low Ref./Feedb. Value****Range:**

0.000\* [-999999.999 - 999999.999 ]

**Function:**

Enter the analog input scaling value that corresponds to the low voltage/low current value set in par. 6-20 *Terminal 54 Low Voltage* and par. 6-22 *Terminal 54 Low Current*.

**6-25 Terminal 54 High Ref./Feedb. Value**

Range:	Function:
100.000* [-999999.999 - 999999.999 ]	Enter the analog input scaling value that corresponds to the high voltage/high current value set in par. 6-21 <i>Terminal 54 High Voltage</i> and par. 6-23 <i>Terminal 54 High Current</i> .

**6-26 Terminal 54 Filter Time Constant**

Range:	Function:
0.001 s* [0.001 - 10.000 s]	Enter the time constant. This is a first-order digital low pass filter time constant for suppressing electrical noise in terminal 54. A high time constant value improves dampening but also increases the time delay through the filter. This parameter cannot be adjusted while the motor is running.

**6-27 Terminal 54 Live Zero**

Option:	Function:
[0] Disabled	This parameter makes it possible to disable the Live Zero monitoring. E.g. to be used if the analog outputs are used as part of a decentral I/O system (e.g. when not part of any frequency converter related control functions, but feeding an external control system with data)
[1] * Enabled	

**2.8.5 6-3\* Analog Input 3 MCB 101**

Parameter group for configuring the scale and limits for analog input 3 (X30/11) placed on option module MCB 101.

**6-30 Terminal X30/11 Low Voltage**

Range:	Function:
0.07 V* [Application dependant]	Sets the analog input scaling value to correspond to the low reference/feedback value (set in par. 6-34 <i>Term. X30/11 Low Ref./Feedb. Value</i> ).

**6-31 Terminal X30/11 High Voltage**

Range:	Function:
10.00 V* [Application dependant]	Sets the analog input scaling value to correspond to the high reference/feedback value (set in par. 6-35 <i>Term. X30/11 High Ref./Feedb. Value</i> ).

**6-34 Term. X30/11 Low Ref./Feedb. Value**

Range:	Function:
0.000* [-999999.999 - 999999.999 ]	Sets the analog input scaling value to correspond to the low voltage value (set in par. 6-30 <i>Terminal X30/11 Low Voltage</i> ).

**6-35 Term. X30/11 High Ref./Feedb. Value**

Range:	Function:
100.000* [-999999.999 - 999999.999 ]	Sets the analog input scaling value to correspond to the high voltage value (set in par. 6-31 <i>Terminal X30/11 High Voltage</i> ).

**6-36 Term. X30/11 Filter Time Constant**

Range:	Function:
0.001 s* [0.001 - 10.000 s]	A 1 <sup>st</sup> order digital low pass filter time constant for suppressing electrical noise on terminal X30/11. par. 6-36 <i>Term. X30/11 Filter Time Constant</i> cannot be changed while the motor is running.

**6-37 Term. X30/11 Live Zero****Option:**

[0] *	Disabled
[1]	Enabled

**Function:**

This parameter makes it possible to disable the Live Zero monitoring. E.g. to be used if the analog outputs are used as part of a decentral I/O system (e.g. when not part of any frequency converter related control functions, but feeding an external control system with data)

**2.8.6 6-4\* Analog Input 4 MCB 101**

Parameter group for configuring the scale and limits for analog input 4 (X30/12) placed on option module MCB 101.

**6-40 Terminal X30/12 Low Voltage****Range:**

0.07 V\* [Application dependant]

**Function:**

Sets the analog input scaling value to correspond to the low reference/feedback value set in par. 6-44 *Term. X30/12 Low Ref./Feedb. Value*.

**6-41 Terminal X30/12 High Voltage****Range:**

10.00 V\* [Application dependant]

**Function:**

Sets the analog input scaling value to correspond to the high reference/feedback value set in par. 6-45 *Term. X30/12 High Ref./Feedb. Value*.

**6-44 Term. X30/12 Low Ref./Feedb. Value****Range:**

0.000\* [-999999.999 - 999999.999 ]

**Function:**

Sets the analog output scaling value to correspond to the low voltage value set in par. 6-40 *Terminal X30/12 Low Voltage*.

**6-45 Term. X30/12 High Ref./Feedb. Value****Range:**

100.000\* [-999999.999 - 999999.999 ]

**Function:**

Sets the analog input scaling value to correspond to the high voltage value set in par. 6-41 *Terminal X30/12 High Voltage*.

**6-46 Term. X30/12 Filter Time Constant****Range:**

0.001 s\* [0.001 - 10.000 s]

**Function:**

A 1<sup>st</sup> order digital low pass filter time constant for suppressing electrical noise on terminal X30/12. par. 6-46 *Term. X30/12 Filter Time Constant* cannot be changed while the motor is running.

**6-47 Term. X30/12 Live Zero**

Option:	Function:
[0] * Disabled	This parameter makes it possible to disable the Live Zero monitoring. E.g. to be used if the analog outputs are used as part of a decentral I/O system (e.g. when not part of any frequency converter related control functions, but feeding an external control system with data)
[1] Enabled	

2

**2.8.7 6-5\* Analog Output 1**

Parameters for configuring the scaling and limits for analog output 1, i.e. Terminal 42. Analog outputs are current outputs: 0/4 – 20 mA. Common terminal (terminal 39) is the same terminal and has the same electrical potential for analog common and digital common connection. Resolution on analog output is 12 bit.

**6-50 Terminal 42 Output**

Option:	Function:
[0] * No operation	Select the function of Terminal 42 as an analog current output. A motor current of 20 mA corresponds to $I_{max}$ .
[100] * Output freq. 0-100	: 0 - 100 Hz, (0-20 mA)
[101] Reference Min-Max	: Minimum reference - Maximum reference, (0-20 mA)
[102] Feedback +-200%	: -200% to +200% of par. 20-14, (0-20 mA)
[103] Motor cur. 0-Imax	: 0 - Inverter Max. Current (par. 16-37), (0-20 mA)
[104] Torque 0-Tlim	: 0 - Torque limit (par. 4-16), (0-20 mA)
[105] Torque 0-Tnom	: 0 - Motor rated torque, (0-20 mA)
[106] Power 0-Pnom	: 0 - Motor rated power, (0-20 mA)
[107] Speed 0-HighLim	: 0 - Speed High Limit (par. 4-13 and par. 4-14), (0-20 mA)
[108] Torque +-160%	: (0-20 mA)
[109] Out frq 0-Fmax	:
[113] Ext. Closed Loop 1	: 0 - 100%, (0-20 mA)
[114] Ext. Closed Loop 2	: 0 - 100%, (0-20 mA)
[115] Ext. Closed Loop 3	: 0 - 100%, (0-20 mA)
[116] Cascade Reference	
[130] Out frq 0-100 4-20mA	: 0 - 100 Hz
[131] Reference 4-20mA	: Minimum Reference - Maximum Reference
[132] Feedback 4-20mA	: -200% to +200% of par. 20-14
[133] Motor cur. 4-20mA	: 0 - Inverter Max. Current (par. 16-37 <i>Inv. Max. Current</i> )
[134] Torq.0-lim 4-20 mA	: 0 - Torque limit (par. 4-16)
[135] Torq.0-nom 4-20 mA	: 0 - Motor rated torque
[136] Power 4-20mA	: 0 - Motor rated power

2

[137]	Speed 4-20mA	: 0 - Speed High Limit (par. 4-13 and par. 4-14)
[138]	Torque 4-20mA	:
[139]	Bus ctrl.	: 0 - 100%, (0-20 mA)
[140]	Bus ctrl. 4-20 mA	: 0 - 100%
[141]	Bus ctrl t.o.	: 0 - 100%, (0-20 mA)
[142]	Bus ctrl t.o. 4-20mA	: 0 - 100%
[143]	Ext. CL 1 4-20mA	: 0 - 100%
[144]	Ext. CL 2 4-20mA	: 0 - 100%
[145]	Ext. CL 3 4-20mA	: 0 - 100%
[146]	Cascade Ref. 4-20mA	:
[150]	Out frq 0-Fmax 4-20mA	:

**NB!**  
Values for setting the Minimum Reference is found in open loop par. 3-02 *Minimum Reference* and for closed loop par. 20-13 *Minimum Reference/Feedb.* - values for maximum reference for open loop is found in par. 3-03 *Maximum Reference* and for closed loop par. 20-14 *Maximum Reference/Feedb.*

**6-51 Terminal 42 Output Min Scale**

<b>Range:</b>	<b>Function:</b>
0.00 %* [0.00 - 200.00 %]	Scale for the minimum output (0 or 4 mA) of the analogue signal at terminal 42. Set the value to be the <b>percentage</b> of the full range of the variable selected in par. 6-50 <i>Terminal 42 Output</i> .

**6-52 Terminal 42 Output Max Scale**

<b>Range:</b>	<b>Function:</b>
100.00 %* [0.00 - 200.00 %]	Scale for the maximum output (20 mA) of the analog signal at terminal 42. Set the value to be the percentage of the full range of the variable selected in par. 6-50 <i>Terminal 42 Output</i> .

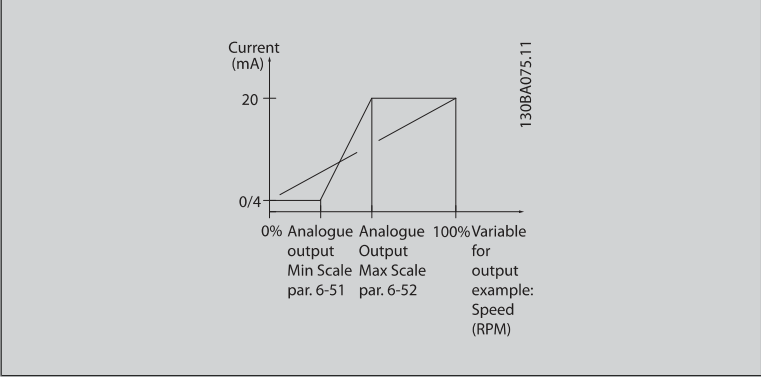

It is possible to get a value lower than 20 mA at full scale by programming values >100% by using a formula as follows:

$$20 \text{ mA} \mid \text{desired maximum current} \times 100 \%$$

i.e.  $10 \text{ mA} : \frac{20 \text{ mA}}{10 \text{ mA}} \times 100 \% = 200 \%$

EXAMPLE 1:

Variable value= OUTPUT FREQUENCY, range = 0-100 Hz

Range needed for output = 0-50 Hz

Output signal 0 or 4 mA is needed at 0 Hz (0% of range) - set par. 6-51 *Terminal 42 Output Min Scale* to 0%

Output signal 20 mA is needed at 50 Hz (50% of range) - set par. 6-52 *Terminal 42 Output Max Scale* to 50%

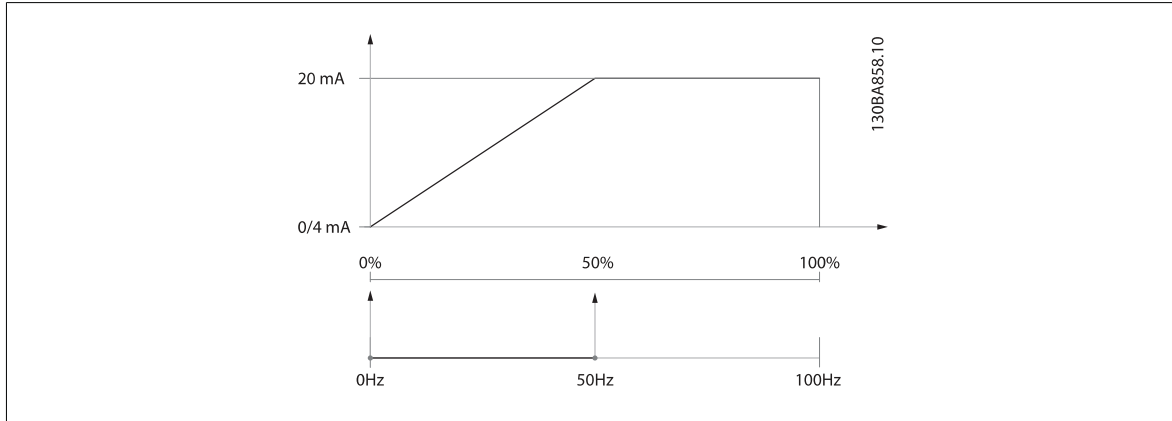

EXAMPLE 2:

Variable= FEEDBACK, range= -200% to +200%

Range needed for output= 0-100%

Output signal 0 or 4 mA is needed at 0% (50% of range) - set par. 6-51 *Terminal 42 Output Min Scale* to 50%

Output signal 20 mA is needed at 100% (75% of range) - set par. 6-52 *Terminal 42 Output Max Scale* to 75%

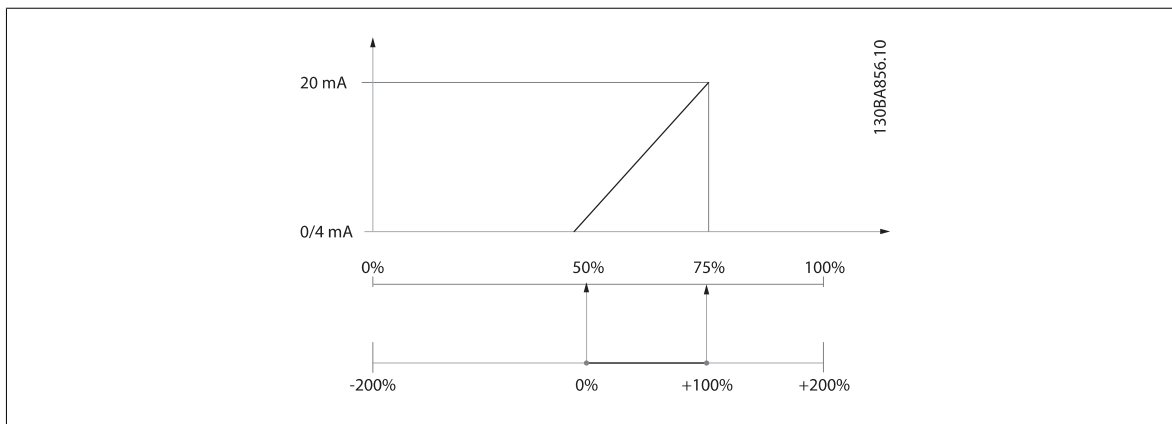

2

EXAMPLE 3:

Variable value= REFERENCE, range= Min ref - Max ref

Range needed for output= Min ref (0%) - Max ref (100%), 0-10 mA

Output signal 0 or 4 mA is needed at Min ref - set par. 6-51 *Terminal 42 Output Min Scale* to 0%

Output signal 10 mA is needed at Max ref (100% of range) - set par. 6-52 *Terminal 42 Output Max Scale* to 200% (20 mA / 10 mA x 100%=200%).

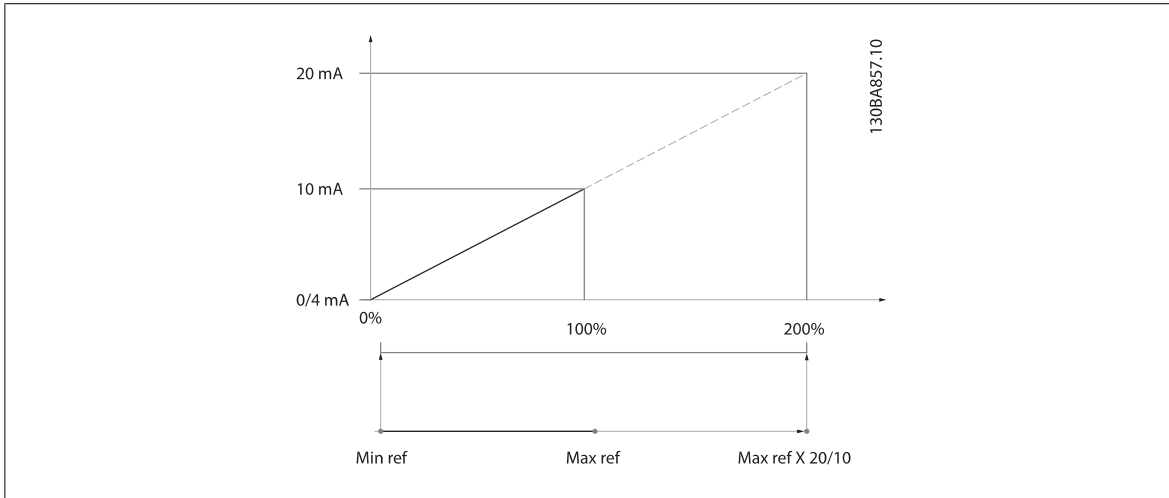

**6-53 Terminal 42 Output Bus Control**

**Range:**

0.00 %\* [0.00 - 100.00 %]

**Function:**

Holds the level of Output 42 if controlled by bus.

**6-54 Terminal 42 Output Timeout Preset**

**Range:**

0.00 %\* [0.00 - 100.00 %]

**Function:**

Holds the preset level of Output 42.  
In case of a bus timeout and a timeout function is selected in par. 6-50 *Terminal 42 Output* the output will preset to this level.

**2.8.8 6-6\* Analog Output 2 MCB 101**

Analog outputs are current outputs: 0/4 - 20 mA. Common terminal (terminal X30/8) is the same terminal and electrical potential for analog common connection. Resolution on analog output is 12 bit.

**6-60 Terminal X30/8 Output**

**Option:**

**Function:**

[0] \* No operation

[100] Output freq. 0-100 : 0 - 100 Hz, (0-20 mA)

[101] Reference Min-Max : Minimum reference - Maximum reference, (0-20 mA)

[102] Feedback +-200% : -200% to +200% of par. 20-14 *Maximum Reference/Feedb.*, (0-20 mA)

[103] Motor cur. 0-Imax : 0 - Inverter Max. Current (par. 16-37 *Inv. Max. Current*), (0-20 mA)

[104] Torque 0-Tlim : 0 - Torque limit (par. 4-16 *Torque Limit Motor Mode*), (0-20 mA)

[105]	Torque 0-Tnom	: 0 - Motor rated torque, (0-20 mA)
[106]	Power 0-Pnom	: 0 - Motor rated power, (0-20 mA)
[107]	Speed 0-HighLim	: 0 - Speed High Limit (par. 4-13 <i>Motor Speed High Limit [RPM]</i> and par. 4-14 <i>Motor Speed High Limit [Hz]</i> ), (0-20 mA)
[108]	Torque +-160%	
[109]	Out frq 0-Fmax	
[113]	Ext. Closed Loop 1	: 0 - 100%, (0-20 mA)
[114]	Ext. Closed Loop 2	: 0 - 100%, (0-20 mA)
[115]	Ext. Closed Loop 3	: 0 - 100%, (0-20 mA)
[116]	Cascade Reference	
[130]	Out frq 0-100 4-20mA	: 0 - 100 Hz
[131]	Reference 4-20mA	: Minimum Reference - Maximum Reference
[132]	Feedback 4-20mA	: -200% to +200% of par. 20-14 <i>Maximum Reference/Feedb.</i>
[133]	Motor cur. 4-20mA	: 0 - Inverter Max. Current (par. 16-37 <i>Inv. Max. Current</i> )
[134]	Torq,0-lim 4-20 mA	: 0 - Torque limit (par. 4-16 <i>Torque Limit Motor Mode</i> )
[135]	Torq,0-nom 4-20 mA	: 0 - Motor rated torque
[136]	Power 4-20mA	: 0 - Motor rated power
[137]	Speed 4-20mA	: 0 - Speed High Limit (4-13 and 4-14)
[138]	Torque 4-20mA	
[139]	Bus ctrl.	: 0 - 100%, (0-20 mA)
[140]	Bus ctrl. 4-20 mA	: 0 - 100%
[141]	Bus ctrl t.o.	: 0 - 100%, (0-20 mA)
[142]	Bus ctrl t.o. 4-20mA	: 0 - 100%
[143]	Ext. CL 1 4-20mA	: 0 - 100%
[144]	Ext. CL 2 4-20mA	: 0 - 100%
[145]	Ext. CL 3 4-20mA	: 0 - 100%
[146]	Cascade Ref. 4-20mA	
[150]	Out frq 0-Fmax 4-20mA	

**6-61 Terminal X30/8 Min. Scale**

**Range:**

0.00 %\* [0.00 - 200.00 %]

**Function:**

Scales the minimum output of the selected analog signal on terminal X30/8. Scale the minimum value as a percentage of the maximum signal value, i.e. 0 mA (or 0 Hz) is desired at 25% of the maximum output value and 25% is programmed. The value can never be higher than the corresponding setting in par. 6-62 *Terminal X30/8 Max. Scale* if value is below 100%.  
This parameter is active when option module MCB 101 is mounted in the frequency converter.

**6-62 Terminal X30/8 Max. Scale****Range:**

100.00 %\* [0.00 - 200.00 %]

**Function:**

Scales the maximum output of the selected analog signal on terminal X30/8. Scale the value to the desired maximum value of the current signal output. Scale the output to give a lower current than 20 mA at full scale or 20 mA at an output below 100% of the maximum signal value. If 20 mA is the desired output current at a value between 0 - 100% of the full-scale output, program the percentage value in the parameter, i.e. 50% = 20 mA. If a current between 4 and 20 mA is desired at maximum output (100%), calculate the percentage value as follows:

$$20 \text{ mA} / \text{desired maximum current} \times 100 \%$$

$$\text{i.e. } 10 \text{ mA} : \frac{20 \text{ mA}}{10 \text{ mA}} \times 100 \% = 200 \%$$

**6-63 Terminal X30/8 Output Bus Control****Range:**

0.00 %\* [0.00 - 100.00 %]

**Function:**

Contains the value to apply to the output terminal, when it is configured as [Bus Controlled].

**6-64 Terminal X30/8 Output Timeout Preset****Range:**

0.00 %\* [0.00 - 100.00 %]

**Function:**

Contains the value to apply to the output terminal, when it is configured as [Bus Controlled Timeout] and time-out is detected.

## 2.8 Main Menu - Communications and Options - Group 8

### 2.9.1 8-\*\*\* Comm. and Options

Parameter group for configuring communications and options.

### 2.9.2 8-0\* General Settings

General settings for communications and options.

#### 8-01 Control Site

**Option:**

**Function:**

The setting in this parameter overrides the settings in par. 8-50 *Coasting Select* to par. 8-56 *Preset Reference Select*.

[0] *	Digital and ctrl.word	Control by using both digital input and control word.
[1]	Digital only	Control by using digital inputs only.
[2]	Controlword only	Control by using control word only.

#### 8-02 Control Word Source

**Option:**

**Function:**

Select the source of the control word: one of two serial interfaces or four installed options. During initial power-up, the frequency converter automatically sets this parameter to *Option A* [3] if it detects a valid fieldbus option installed in slot A. If the option is removed, the frequency converter detects a change in the configuration, sets par. 8-02 back to default setting *FC Port*, and the frequency converter then trips. If an option is installed after initial power-up, the setting of par. 8-02 will not change but the frequency converter will trip and display: Alarm 67 *Option Changed*. This parameter cannot be adjusted while the motor is running.

[0]	None
[1]	FC Port
[2]	FC USB
[3]	Option A
[4]	Option B
[5]	Option C0
[6]	Option C1

### 8-03 Control Timeout Time

**Range:**

Application [1.0 - 18000.0 s]  
dependent\*

**Function:**

Enter the maximum time expected to pass between the reception of two consecutive telegrams. If this time is exceeded, it indicates that the serial communication has stopped. The function selected in par. 8-04 *Control Timeout Function Control Time-out Function* will then be carried out.

In LonWorks the following variables will trigger the Control Word Time parameter:

nviStartStop  
nviReset Fault  
nviControlWord  
nviDrvSpeedStpt  
nviRefPcnt  
nviRefHz

### 8-04 Control Timeout Function

**Option:**
**Function:**

Select the time-out function. The time-out function is activated when the control word fails to be updated within the time period specified in par. 8-03 *Control Timeout Time*. Choice [20] only appears after setting the N2 protocol.

[0] *	Off
[1]	Freeze output
[2]	Stop
[3]	Jogging
[4]	Max. speed
[5]	Stop and trip
[7]	Select setup 1
[8]	Select setup 2
[9]	Select setup 3
[10]	Select setup 4
[20]	N2 Override Release

In LonWorks, the time-out function is also activated when the following SNVT's fail to be updated within the time period specified in par. 8-03 *Control Timeout Time*.

nviStartStop	nviDrvSpeedStpt
nviReset Fault	nviRefPcnt
nviControlWord	nviRefHz

### 8-05 End-of-Timeout Function

**Option:**
**Function:**

Select the action after receiving a valid control word following a time-out. This parameter is active only when par. 8-04 *Control Timeout Function* is set to [Set-up 1-4].

[0]	Hold set-up	Retains the set-up selected in par. 8-04 <i>Control Timeout Function</i> and displays a warning, until par. 8-06 <i>Reset Control Timeout</i> toggles. Then the frequency converter resumes its original set-up.
[1] *	Resume set-up	Resumes the set-up active prior to the time-out.

### 8-06 Reset Control Timeout

Option:	Function:
	This parameter is active only when the choice <i>Hold set-up</i> [0] has been selected in par. 8-05 <i>End-of-Timeout Function</i> .
[0] * Do not reset	Retains the set-up specified in par. 8-04 <i>Control Timeout Function</i> , [Select setup 1-4] following a control time-out.
[1] Do reset	Returns the frequency converter to the original set-up following a control word time-out. When the value is set to <i>Do reset</i> [1], the frequency converter performs the reset and then immediately reverts to the <i>Do not reset</i> [0] setting.

### 8-07 Diagnosis Trigger

Option:	Function:
	This parameter has no function for LonWorks.
[0] * Disable	
[1] Trigger on alarms	
[2] Trigger alarm/warn.	

## 2.9.3 8-1\* Ctrl. Word Settings

Parameters for configuring the option control word profile.

### 8-10 Control Profile

Option:	Function:
	Select the interpretation of the control and status words corresponding to the installed fieldbus. Only the selections valid for the fieldbus installed in slot A will be visible in the LCP display.
[0] * FC profile	
[1] PROFIdrive profile	
[5] ODVA	
[7] CANopen DSP 402	

### 8-13 Configurable Status Word STW

Option:	Function:
	This parameter enables configuration of bits 12 – 15 in the status word.
[0] No function	
[1] * Profile Default	Function corresponds to the profile default selected in par. 8-10 <i>Control Profile</i> .
[2] Alarm 68 Only	Only set in case of an Alarm 68.
[3] Trip excl Alarm 68	Set in case of a trip, except if the trip is executed by an Alarm 68.
[16] T37 DI status	The bit indicates the status of terminal 37. "0" indicates T37 is low (safe stop) "1" indicates T37 is high (normal)

## 2.9.4 8-3\* FC Port Settings

Parameters for configuring the FC Port.

**8-30 Protocol**

Option:	Function:
[0] * FC	Protocol selection for the integrated FC (standard) Port (RS485) on the control card.
[1] FC MC	Communication according to the FC Protocol as described in <i>RS-485 Installation and Set-up</i> .
[2] Modbus RTU	Same as FC [0] but to be used when downloading SW to the frequency converter or uploading dll file (covering information regarding parameters available in the frequency converter and their inter-dependencies) to Motion Control Tool MCT10.
[9] FC option	Communication according to the Modbus RTU protocol.

**8-31 Address**

Range:	Function:
Application [Application dependant] dependent*	

**8-32 Baud Rate**

Option:	Function:
	Baud rate selection depends on Protocol selection in par. 8-30 <i>Protocol</i> .
[0] 2400 Baud	
[1] 4800 Baud	
[2] * 9600 Baud	
[3] 19200 Baud	
[4] 38400 Baud	
[5] 57600 Baud	
[6] 76800 Baud	
[7] 115200 Baud	

Default refers to the FC Protocol.

**8-33 Parity / Stop Bits**

Option:	Function:
	Parity and Stop Bits for the protocol par. 8-30 <i>Protocol</i> using the FC Port. For some of the protocols, not all options will be visible. Default depends on the protocol selected.
[0] * Even Parity, 1 Stop Bit	
[1] Odd Parity, 1 Stop Bit	
[2] No Parity, 1 Stop Bit	
[3] No Parity, 2 Stop Bits	

**8-35 Minimum Response Delay**

Range:	Function:
Application [Application dependant] dependent*	

**8-36 Max Response Delay**

Range:	Function:
Application [Application dependant] dependent*	

**8-37 Maximum Inter-Char Delay**

Range:	Function:
Application [Application dependant] dependent*	

**8-40 Telegram Selection**

Option:	Function:
	Enables use of freely configurable telegrams or standard telegrams for the FC port.

[1] *	Standard telegram 1
[100]	None
[101]	PPO 1
[102]	PPO 2
[103]	PPO 3
[104]	PPO 4
[105]	PPO 5
[106]	PPO 6
[107]	PPO 7
[108]	PPO 8
[200]	Custom telegram 1
[202]	Custom telegram 3

**2.9.5 8-5\* Digital/Bus**

Parameters for configuring the control word Digital/Bus merging.

**8-50 Coasting Select**

Option:	Function:
	Select control of the coasting function via the terminals (digital input) and/or via the bus.
[0]	Digital input Activates Start command via a digital input.
[1]	Bus Activates Start command via the serial communication port or fieldbus option.
[2]	Logic AND Activates Start command via the fieldbus/serial communication port, AND additionally via one of the digital inputs.
[3] *	Logic OR Activates Start command via the fieldbus/serial communication port OR via one of the digital inputs.



**NB!**

This parameter is active only when par. 8-01 *Control Site* is set to [0] *Digital and control word*.

### 8-52 DC Brake Select

Option:	Function:
	Select control of the DC brake via the terminals (digital input) and/or via the fieldbus.
[0] Digital input	Activates Start command via a digital input.
[1] Bus	Activates Start command via the serial communication port or fieldbus option.
[2] Logic AND	Activates Start command via the fieldbus/serial communication port, AND additionally via one of the digital inputs.
[3] * Logic OR	Activates Start command via the fieldbus/serial communication port OR via one of the digital inputs.

**NB!**

This parameter is active only when par. 8-01 *Control Site* is set to [0] *Digital and control word*.

### 8-53 Start Select

Option:	Function:
	Select control of the frequency converter start function via the terminals (digital input) and/or via the fieldbus.
[0] Digital input	Activates Start command via a digital input.
[1] Bus	Activates Start command via the serial communication port or fieldbus option.
[2] Logic AND	Activates Start command via the fieldbus/serial communication port, AND additionally via one of the digital inputs.
[3] * Logic OR	Activates Start command via the fieldbus/serial communication port OR via one of the digital inputs.

**NB!**

This parameter is active only when par. 8-01 *Control Site* is set to [0] *Digital and control word*.

### 8-54 Reversing Select

Option:	Function:
	Select control of the frequency converter reverse function via the terminals (digital input) and/or via the fieldbus.
[0] * Digital input	Activates Reverse command via a digital input.
[1] Bus	Activates Reverse command via the serial communication port or fieldbus option.
[2] Logic AND	Activates Reverse command via the fieldbus/serial communication port, AND additionally via one of the digital inputs.
[3] Logic OR	Activates Reverse command via the fieldbus/serial communication port OR via one of the digital inputs.

**NB!**

This parameter is active only when par. 8-01 *Control Site* is set to [0] *Digital and control word*.

### 8-55 Set-up Select

Option:	Function:
	Select control of the frequency converter set-up selection via the terminals (digital input) and/or via the fieldbus.
[0] Digital input	Activates the set-up selection via a digital input.
[1] Bus	Activates the set-up selection via the serial communication port or fieldbus option.
[2] Logic AND	Activates the set-up selection via the fieldbus/serial communication port, AND additionally via one of the digital inputs.
[3] * Logic OR	Activate the set-up selection via the fieldbus/serial communication port OR via one of the digital inputs.

 **NB!**  
This parameter is active only when par. 8-01 *Control Site* is set to [0] *Digital and control word*.

### 8-56 Preset Reference Select

Option:	Function:
	Select control of the frequency converter Preset Reference selection via the terminals (digital input) and/or via the fieldbus.
[0] Digital input	Activates Preset Reference selection via a digital input.
[1] Bus	Activates Preset Reference selection via the serial communication port or fieldbus option.
[2] Logic AND	Activates Preset Reference selection via the fieldbus/serial communication port, AND additionally via one of the digital inputs.
[3] * Logic OR	Activates the Preset Reference selection via the fieldbus/serial communication port OR via one of the digital inputs.

 **NB!**  
This parameter is active only when par. 8-01 *Control Site* is set to [0] *Digital and control word*.

## 2.9.6 8-8\* FC Port Diagnostics

These parameters are used for monitoring the Bus communication via the FC Port.

### 8-80 Bus Message Count

Range:	Function:
0* [0 - 0]	This parameter shows the number of valid telegrams detected on the bus.

### 8-81 Bus Error Count

Range:	Function:
0* [0 - 0]	This parameter shows the number of telegrams with faults (e.g. CRC fault), detected on the bus.

## 2

**8-82 Slave Message Rcvd****Range:**

0\* [0 - 0 ]

**Function:**

This parameter shows the number of valid telegrams addressed to the slave, sent by the frequency converter.

**8-83 Slave Error Count****Range:**

0\* [0 - 0 ]

**Function:**

This parameter shows the number of error telegrams, which could not be executed by the frequency converter.

**2.9.7 8-9\* Bus Jog**

Parameters for configuring the Bus Jog.

**8-90 Bus Jog 1 Speed****Range:**

100 RPM\* [Application dependant]

**Function:**

Enter the jog speed. This is a fixed jog speed activated via the serial port or fieldbus option.

**8-91 Bus Jog 2 Speed****Range:**

200 RPM\* [Application dependant]

**Function:**

Enter the jog speed. This is a fixed jog speed activated via the serial port or fieldbus option.

### 8-94 Bus Feedback 1

**Range:**

0\* [-200 - 200 ]

**Function:**

Write a feedback to this parameter via the serial communication port or fieldbus option. This parameter must be selected in par. 20-00 *Feedback 1 Source*, par. 20-03 *Feedback 2 Source* or par. 20-06 *Feedback 3 Source* as a feedback source.

### 8-95 Bus Feedback 2

**Range:**

0\* [-200 - 200 ]

**Function:**

See par. 8-94 *Bus Feedback 1* for further details.

### 8-96 Bus Feedback 3

**Range:**

0\* [-200 - 200 ]

**Function:**

See par. 8-94 *Bus Feedback 1* for further details.

2

## 2.9 Main Menu - Profibus - Group 9

### 2.10.1 9-\*\* Profibus

2

Parameter group for all Profibus-specific parameters. Only available if Profibus option is mounted

#### 9-15 PCD Write Configuration

Array [10]

##### Option:

##### Function:

Select the parameters to be assigned to PCD 3 to 10 of the telegrams. The number of available PCDs depends on the telegram type. The values in PCD 3 to 10 will then be written to the selected parameters as data values. Alternatively, specify a standard Profibus telegram in par. 9-22 *Telegram Selection*.

[0] *	None
[302]	Minimum Reference
[303]	Maximum Reference
[341]	Ramp 1 Ramp Up Time
[342]	Ramp 1 Ramp Down Time
[351]	Ramp 2 Ramp Up Time
[352]	Ramp 2 Ramp Down Time
[380]	Jog Ramp Time
[381]	Quick Stop Ramp Time
[411]	Motor Speed Low Limit [RPM]
[413]	Motor Speed High Limit [RPM]
[416]	Torque Limit Motor Mode
[417]	Torque Limit Generator Mode
[590]	Digital & Relay Bus Control
[593]	Pulse Out #27 Bus Control
[595]	Pulse Out #29 Bus Control
[597]	Pulse Out #X30/6 Bus Control
[653]	Terminal 42 Output Bus Control
[663]	Terminal X30/8 Output Bus Control
[890]	Bus Jog 1 Speed
[891]	Bus Jog 2 Speed
[894]	Bus Feedback 1
[895]	Bus Feedback 2
[896]	Bus Feedback 3
[1680]	Fieldbus CTW 1
[1682]	Fieldbus REF 1
[1685]	FC Port CTW 1
[1686]	FC Port REF 1
[2643]	Terminal X42/7 Bus Control
[2653]	Terminal X42/9 Bus Control
[2663]	Terminal X42/11 Bus Control

### 9-16 PCD Read Configuration

Array [10]

**Option:**

**Function:**

Select the parameters to be assigned to PCD 3 to 10 of the telegrams. The number of available PCDs depends on the telegram type. PCDs 3 to 10 contain the actual data values of the selected parameters. For standard Profibus telegram, see par. 9-22. *Telegram Selection.*

[0] *	None
[894]	Bus Feedback 1
[895]	Bus Feedback 2
[896]	Bus Feedback 3
[1500]	Operating Hours
[1501]	Running Hours
[1502]	kWh Counter
[1600]	Control Word
[1601]	Reference [Unit]
[1602]	Reference [%]
[1603]	Status Word
[1605]	Main Actual Value [%]
[1609]	Custom Readout
[1610]	Power [kW]
[1611]	Power [hp]
[1612]	Motor Voltage
[1613]	Frequency
[1614]	Motor Current
[1615]	Frequency [%]
[1616]	Torque [Nm]
[1617]	Speed [RPM]
[1618]	Motor Thermal
[1622]	Torque [%]
[1630]	DC Link Voltage
[1632]	Brake Energy /s
[1633]	Brake Energy /2 min
[1634]	Heatsink Temp.
[1635]	Inverter Thermal
[1638]	SL Controller State
[1639]	Control Card Temp.
[1650]	External Reference
[1652]	Feedback [Unit]
[1653]	Digi Pot Reference
[1654]	Feedback 1 [Unit]
[1655]	Feedback 2 [Unit]
[1656]	Feedback 3 [Unit]
[1660]	Digital Input
[1661]	Terminal 53 Switch Setting

## 2

[1662]	Analog Input 53
[1663]	Terminal 54 Switch Setting
[1664]	Analog Input 54
[1665]	Analog Output 42 [mA]
[1666]	Digital Output [bin]
[1667]	Pulse Input #29 [Hz]
[1668]	Pulse Input #33 [Hz]
[1669]	Pulse Output #27 [Hz]
[1670]	Pulse Output #29 [Hz]
[1671]	Relay Output [bin]
[1672]	Counter A
[1673]	Counter B
[1675]	Analog In X30/11
[1676]	Analog In X30/12
[1677]	Analog Out X30/8 [mA]
[1684]	Comm. Option STW
[1690]	Alarm Word
[1691]	Alarm Word 2
[1692]	Warning Word
[1693]	Warning Word 2
[1694]	Ext. Status Word
[1695]	Ext. Status Word 2
[1696]	Maintenance Word
[1830]	Analog Input X42/1
[1831]	Analog Input X42/3
[1832]	Analog Input X42/5
[1833]	Analog Out X42/7 [V]
[1834]	Analog Out X42/9 [V]
[1835]	Analog Out X42/11 [V]
[1860]	Digital Input 2
[2795]	Advanced Cascade Relay Output [bin]
[2796]	Extended Cascade Relay Output [bin]

## 9-18 Node Address

Range:	Function:
126* [Application dependant]	Enter the station address in this parameter or alternatively in the hardware switch. In order to adjust the station address in par. 9-18 <i>Node Address</i> , the hardware switch must be set to 126 or 127 (i.e. all switches set to 'on'). Otherwise this parameter will display the actual setting of the switch.

### 9-22 Telegram Selection

Option:	Function:
	Select a standard Profibus telegram configuration for the frequency converter, as an alternative to using the freely configurable telegrams in par. 9-15 <i>PCD Write Configuration</i> and par. 9-16 <i>PCD Read Configuration</i> .
[1]	Standard telegram 1
[100] *	None
[101]	PPO 1
[102]	PPO 2
[103]	PPO 3
[104]	PPO 4
[105]	PPO 5
[106]	PPO 6
[107]	PPO 7
[108] *	PPO 8
[200]	Custom telegram 1
[202]	Custom telegram 3

### 9-23 Parameters for Signals

Array [1000]

Option:	Function:
	This parameter contains a list of signals available for selection in par. 9-15 <i>PCD Write Configuration</i> and par. 9-16 <i>PCD Read Configuration</i> .
[0] *	None
[302]	Minimum Reference
[303]	Maximum Reference
[341]	Ramp 1 Ramp Up Time
[342]	Ramp 1 Ramp Down Time
[351]	Ramp 2 Ramp Up Time
[352]	Ramp 2 Ramp Down Time
[380]	Jog Ramp Time
[381]	Quick Stop Ramp Time
[411]	Motor Speed Low Limit [RPM]
[413]	Motor Speed High Limit [RPM]
[416]	Torque Limit Motor Mode
[417]	Torque Limit Generator Mode
[590]	Digital & Relay Bus Control
[593]	Pulse Out #27 Bus Control
[595]	Pulse Out #29 Bus Control
[597]	Pulse Out #X30/6 Bus Control
[653]	Terminal 42 Output Bus Control
[663]	Terminal X30/8 Output Bus Control
[890]	Bus Jog 1 Speed
[891]	Bus Jog 2 Speed

## 2

[894]	Bus Feedback 1
[895]	Bus Feedback 2
[896]	Bus Feedback 3
[1500]	Operating Hours
[1501]	Running Hours
[1502]	kWh Counter
[1600]	Control Word
[1601]	Reference [Unit]
[1602]	Reference [%]
[1603]	Status Word
[1605]	Main Actual Value [%]
[1609]	Custom Readout
[1610]	Power [kW]
[1611]	Power [hp]
[1612]	Motor Voltage
[1613]	Frequency
[1614]	Motor Current
[1615]	Frequency [%]
[1616]	Torque [Nm]
[1617]	Speed [RPM]
[1618]	Motor Thermal
[1622]	Torque [%]
[1630]	DC Link Voltage
[1632]	Brake Energy /s
[1633]	Brake Energy /2 min
[1634]	Heatsink Temp.
[1635]	Inverter Thermal
[1638]	SL Controller State
[1639]	Control Card Temp.
[1650]	External Reference
[1652]	Feedback [Unit]
[1653]	Digi Pot Reference
[1654]	Feedback 1 [Unit]
[1655]	Feedback 2 [Unit]
[1656]	Feedback 3 [Unit]
[1660]	Digital Input
[1661]	Terminal 53 Switch Setting
[1662]	Analog Input 53
[1663]	Terminal 54 Switch Setting
[1664]	Analog Input 54
[1665]	Analog Output 42 [mA]
[1666]	Digital Output [bin]
[1667]	Pulse Input #29 [Hz]

[1668]	Pulse Input #33 [Hz]
[1669]	Pulse Output #27 [Hz]
[1670]	Pulse Output #29 [Hz]
[1671]	Relay Output [bin]
[1672]	Counter A
[1673]	Counter B
[1675]	Analog In X30/11
[1676]	Analog In X30/12
[1677]	Analog Out X30/8 [mA]
[1680]	Fieldbus CTW 1
[1682]	Fieldbus REF 1
[1684]	Comm. Option STW
[1685]	FC Port CTW 1
[1686]	FC Port REF 1
[1690]	Alarm Word
[1691]	Alarm Word 2
[1692]	Warning Word
[1693]	Warning Word 2
[1694]	Ext. Status Word
[1695]	Ext. Status Word 2
[1696]	Maintenance Word
[1830]	Analog Input X42/1
[1831]	Analog Input X42/3
[1832]	Analog Input X42/5
[1833]	Analog Out X42/7 [V]
[1834]	Analog Out X42/9 [V]
[1835]	Analog Out X42/11 [V]
[1860]	Digital Input 2
[2643]	Terminal X42/7 Bus Control
[2653]	Terminal X42/9 Bus Control
[2663]	Terminal X42/11 Bus Control
[2795]	Advanced Cascade Relay Output [bin]
[2796]	Extended Cascade Relay Output [bin]

**9-27 Parameter Edit**

Option:	Function:
	Parameters can be edited via Profibus, the standard RS485 interface, or the LCP.
[0]	Disabled Disables editing via Profibus.
[1] *	Enabled Enables editing via Profibus.

**9-28 Process Control****2****Option:****Function:**

Process control (setting of Control Word, speed reference, and process data) is possible via either Profibus or standard fieldbus but not both simultaneously. Local control is always possible via the LCP. Control via process control is possible via either terminals or fieldbus depending on the settings in par. 8-50 *Coasting Select* to par. 8-56 *Preset Reference Select*.

[0]	Disable	Disables process control via Profibus, and enables process control via standard fieldbus or Profibus Master class 2.
[1] *	Enable cyclic master	Enables process control via Profibus Master Class 1, and disables process control via standard fieldbus or Profibus Master class 2.

**9-53 Profibus Warning Word**

Range:	Function:
0* [0 - 65535 ]	This parameter displays Profibus communication warnings. Please refer to the <i>Profibus Operating Instructions</i> for further information.

Read only

Bit:	Meaning:
0	Connection with DP-master is not ok
1	Not used
2	FDLNDL (Fieldbus Data link Layer) is not ok
3	Clear data command received
4	Actual value is not updated
5	Baudrate search
6	PROFIBUS ASIC is not transmitting
7	Initializing of PROFIBUS is not ok
8	Frequency converter is tripped
9	Internal CAN error
10	Wrong configuration data from PLC
11	Wrong ID sent by PLC
12	Internal error occurred
13	Not configured
14	Timeout active
15	Warning 34 active

**9-63 Actual Baud Rate**

Option:	Function:
	This parameter displays the actual Profibus baud rate. The Profibus Master automatically sets the baud rate.

[0]	9,6 kbit/s
[1]	19,2 kbit/s
[2]	93,75 kbit/s
[3]	187,5 kbit/s
[4]	500 kbit/s
[6]	1500 kbit/s
[7]	3000 kbit/s
[8]	6000 kbit/s
[9]	12000 kbit/s
[10]	31,25 kbit/s
[11]	45,45 kbit/s
[255] *	No baudrate found

**9-65 Profile Number**

Range:	Function:
0* [0 - 0 ]	This parameter contains the profile identification. Byte 1 contains the profile number and byte 2 the version number of the profile.



**NB!**

This parameter is not visible via LCP.

2

**9-70 Programming Set-up**

Option:	Function:
	Select the set-up to be edited.
[0] Factory setup	Uses default data. This option can be used as a data source to return the other set-ups to a known state.
[1] Set-up 1	Edits Set-up 1.
[2] Set-up 2	Edits Set-up 2.
[3] Set-up 3	Edits Set-up 3.
[4] Set-up 4	Edits Set-up 4.
[9] * Active Set-up	Follows the active set-up selected in par. 0-10 <i>Active Set-up</i> .

This parameter is unique to LCP and fieldbuses. See also par. 0-11 *Programming Set-up*.

**9-71 Profibus Save Data Values**

Option:	Function:
	Parameter values changed via Profibus are not automatically stored in non-volatile memory. Use this parameter to activate a function that stores parameter values in the EEPROM non-volatile memory, so changed parameter values will be retained at power-down.
[0] * Off	Deactivates the non-volatile storage function.
[1] Store edit setup	Stores all parameter values for all set-ups in the non-volatile memory. The selection returns to <i>Off</i> [0] when all parameter values have been stored.
[2] Store all setups	Stores all parameter values for all set-ups in the non-volatile memory. The selection returns to <i>Off</i> [0] when all parameter values have been stored.

**9-72 ProfibusDriveReset**

Option:	Function:
[0] * No action	
[1] Power-on reset	Resets frequency converter upon power-up, as for power-cycle.
[2] Power-on reset prep	
[3] Comm option reset	Resets the Profibus option only, useful after changing certain settings in parameter group 9-**, e.g. par. 9-18 <i>Node Address</i> . When reset, the frequency converter disappears from the fieldbus, which may cause a communication error from the master.

**9-80 Defined Parameters (1)**

Array [116]	
No LCP access	
Read only	
Range:	Function:
0* [0 - 9999 ]	This parameter displays a list of all the defined frequency converter parameters available for Profibus.

**9-81 Defined Parameters (2)**

Array [116]  
No LCP access  
Read only

**Range:**

0\* [0 - 9999 ]

**Function:**

This parameter displays a list of all the defined frequency converter parameters available for Profibus.

**9-82 Defined Parameters (3)**

Array [116]  
No LCP access  
Read only

**Range:**

0\* [0 - 9999 ]

**Function:**

This parameter displays a list of all the defined frequency converter parameters available for Profibus.

**9-83 Defined Parameters (4)**

Array [116]  
No LCP access  
Read only

**Range:**

0\* [0 - 9999 ]

**Function:**

This parameter displays a list of all the defined frequency converter parameters available for Profibus.

**9-90 Changed Parameters (1)**

Array [116]  
No LCP access  
Read only

**Range:**

0\* [0 - 9999 ]

**Function:**

This parameter displays a list of all the frequency converter parameters deviating from default setting.

**9-91 Changed Parameters (2)**

Array [116]  
No LCP access  
Read only

**Range:**

0\* [0 - 9999 ]

**Function:**

This parameter displays a list of all the frequency converter parameters deviating from default setting.

**9-92 Changed Parameters (3)**

Array [116]  
No LCP access  
Read only

**Range:**

0\* [0 - 9999 ]

**Function:**

This parameter displays a list of all the frequency converter parameters deviating from default setting.

**9-94 Changed Parameters (5)**

Array [116]  
No LCP Address  
Read only

**Range:**

0\* [0 - 9999 ]

**Function:**

This parameter displays a list of all the frequency converter parameters deviating from default setting.

**2**

## 2

## 2.10 Main Menu - CAN Fieldbus - Group 10

### 2.11.1 10-\*\* DeviceNet and CAN Fieldbus

Parameter group for DeviceNet CAN fieldbus parameters.

### 2.11.2 10-0\* Common Settings

Parameter group for configuring common settings for CAN fieldbus options.

#### 10-00 CAN Protocol

Option:	Function:
[1] * DeviceNet	View the active CAN protocol.



**NB!**

The options depend on installed option

#### 10-01 Baud Rate Select

Option:	Function:
	Select the fieldbus transmission speed. The selection must correspond to the transmission speed of the master and the other fieldbus nodes.

[16]	10 Kbps
[17]	20 Kbps
[18]	50 Kbps
[19]	100 Kbps
[20] *	125 Kbps
[21]	250 Kbps
[22]	500 Kbps
[23]	800 Kbps
[24]	1000 Kbps

#### 10-02 MAC ID

Range:	Function:
Application dependent*	[Application dependant]

#### 10-05 Readout Transmit Error Counter

Range:	Function:
0* [0 - 255 ]	View the number of CAN control transmission errors since the last power-up.

#### 10-06 Readout Receive Error Counter

Range:	Function:
0* [0 - 255 ]	View the number of CAN control receipt errors since the last power-up.

**10-07 Readout Bus Off Counter**

Range:	Function:
0* [0 - 255 ]	View the number of Bus Off events since the last power-up.

**2.11.3 10-1\* DeviceNet**

Parameters specific to the DeviceNet fieldbus.

**10-10 Process Data Type Selection**

Option:	Function:
	<p>Select the Instance (telegram) for data transmission. The Instances available are dependent upon the setting of par. 8-10 <i>Control Profile</i>.</p> <p>When par. 8-10 <i>Control Profile</i> is set to [0] <i>FC profile</i>, par. 10-10 <i>Process Data Type Selection</i> options [0] and [1] are available.</p> <p>When par. 8-10 <i>Control Profile</i> is set to [5] <i>ODVA</i>, par. 10-10 <i>Process Data Type Selection</i> options [2] and [3] are available.</p> <p>Instances 100/150 and 101/151 are Danfoss-specific. Instances 20/70 and 21/71 are ODVA-specific AC Drive profiles.</p> <p>For guidelines in telegram selection, please refer to the DeviceNet Operating Instructions.</p> <p>Note that a change to this parameter will be executed immediately.</p>

[0] *	INSTANCE 100/150
[1]	INSTANCE 101/151
[2]	INSTANCE 20/70
[3]	INSTANCE 21/71

**10-11 Process Data Config Write**

Option:	Function:
	Select the process write data for I/O Assembly Instances 101/151. Elements [2] and [3] of this array can be selected. Elements [0] and [1] of the array are fixed.

[0] *	None
[302]	Minimum Reference
[303]	Maximum Reference
[341]	Ramp 1 Ramp Up Time
[342]	Ramp 1 Ramp Down Time
[351]	Ramp 2 Ramp Up Time
[352]	Ramp 2 Ramp Down Time
[380]	Jog Ramp Time
[381]	Quick Stop Ramp Time
[411]	Motor Speed Low Limit [RPM]
[413]	Motor Speed High Limit [RPM]
[416]	Torque Limit Motor Mode
[417]	Torque Limit Generator Mode
[590]	Digital & Relay Bus Control
[593]	Pulse Out #27 Bus Control
[595]	Pulse Out #29 Bus Control
[597]	Pulse Out #X30/6 Bus Control

[653]	Terminal 42 Output Bus Control
[663]	Terminal X30/8 Output Bus Control
[890]	Bus Jog 1 Speed
[891]	Bus Jog 2 Speed
[894]	Bus Feedback 1
[895]	Bus Feedback 2
[896]	Bus Feedback 3
[1680]	Fieldbus CTW 1
[1682]	Fieldbus REF 1
[1685]	FC Port CTW 1
[1686]	FC Port REF 1
[2643]	Terminal X42/7 Bus Control
[2653]	Terminal X42/9 Bus Control
[2663]	Terminal X42/11 Bus Control

### 10-12 Process Data Config Read

**Option:**
**Function:**

Select the process read data for I/O Assembly Instances 101/151. Elements [2] and [3] of this array can be selected. Elements [0] and [1] of the array are fixed.

[0] *	None
[894]	Bus Feedback 1
[895]	Bus Feedback 2
[896]	Bus Feedback 3
[1500]	Operating Hours
[1501]	Running Hours
[1502]	kWh Counter
[1600]	Control Word
[1601]	Reference [Unit]
[1602]	Reference [%]
[1603]	Status Word
[1605]	Main Actual Value [%]
[1609]	Custom Readout
[1610]	Power [kW]
[1611]	Power [hp]
[1612]	Motor Voltage
[1613]	Frequency
[1614]	Motor Current
[1615]	Frequency [%]
[1616]	Torque [Nm]
[1617]	Speed [RPM]
[1618]	Motor Thermal
[1622]	Torque [%]
[1630]	DC Link Voltage
[1632]	Brake Energy /s

[1633]	Brake Energy /2 min
[1634]	Heatsink Temp.
[1635]	Inverter Thermal
[1638]	SL Controller State
[1639]	Control Card Temp.
[1650]	External Reference
[1652]	Feedback [Unit]
[1653]	Digi Pot Reference
[1654]	Feedback 1 [Unit]
[1655]	Feedback 2 [Unit]
[1656]	Feedback 3 [Unit]
[1660]	Digital Input
[1661]	Terminal 53 Switch Setting
[1662]	Analog Input 53
[1663]	Terminal 54 Switch Setting
[1664]	Analog Input 54
[1665]	Analog Output 42 [mA]
[1666]	Digital Output [bin]
[1667]	Pulse Input #29 [Hz]
[1668]	Pulse Input #33 [Hz]
[1669]	Pulse Output #27 [Hz]
[1670]	Pulse Output #29 [Hz]
[1671]	Relay Output [bin]
[1672]	Counter A
[1673]	Counter B
[1675]	Analog In X30/11
[1676]	Analog In X30/12
[1677]	Analog Out X30/8 [mA]
[1684]	Comm. Option STW
[1690]	Alarm Word
[1691]	Alarm Word 2
[1692]	Warning Word
[1693]	Warning Word 2
[1694]	Ext. Status Word
[1695]	Ext. Status Word 2
[1696]	Maintenance Word
[1830]	Analog Input X42/1
[1831]	Analog Input X42/3
[1832]	Analog Input X42/5
[1833]	Analog Out X42/7 [V]
[1834]	Analog Out X42/9 [V]
[1835]	Analog Out X42/11 [V]
[1860]	Digital Input 2

[2795]    Advanced   Cascade   Relay   Output  
         [bin]

[2796]    Extended   Cascade   Relay   Output  
         [bin]

**2**

**10-13 Warning Parameter**

<b>Range:</b>	<b>Function:</b>
0* [0 - 65535 ]	View a DeviceNet-specific Warning word. One bit is assigned to every warning. Please refer to the DeviceNet Operating Instructions (MG.33.DX.YY) for further information.

Bit:	Meaning:
0	Bus not active
1	Explicit connection timeout
2	I/O connection
3	Retry limit reached
4	Actual is not updated
5	CAN bus off
6	I/O send error
7	Initialization error
8	No bus supply
9	Bus off
10	Error passive
11	Error warning
12	Duplicate MAC ID Error
13	RX queue overrun
14	TX queue overrun
15	CAN overrun

**10-14 Net Reference**

Read only from LCP

<b>Option:</b>	<b>Function:</b>
	Select the reference source in Instance 21/71 and 20/70.
[0] * Off	Enables reference via analog/digital inputs.
[1] On	Enables reference via the fieldbus.

**10-15 Net Control**

Read only from LCP

<b>Option:</b>	<b>Function:</b>
	Select the control source in Instance 21/71 and 20/70.
[0] * Off	Enables control via analog/digital inputs.
[1] On	Enable control via the fieldbus.

**2.11.4 10-2\* COS Filters**

Parameters for configuring COS filter settings.

**10-20 COS Filter 1**

<b>Range:</b>	<b>Function:</b>
0* [0 - 65535 ]	Enter the value for COS Filter 1 to set up the filter mask for the Status Word. When operating in COS (Change-Of-State), this function filters out bits in the Status Word that should not be sent if they change.

**10-21 COS Filter 2****Range:**

0\* [0 - 65535 ]

**Function:**

Enter the value for COS Filter 2, to set up the filter mask for the Main Actual Value. When operating in COS (Change-Of-State), this function filters out bits in the Main Actual Value that should not be sent if they change.

**10-22 COS Filter 3****Range:**

0\* [0 - 65535 ]

**Function:**

Enter the value for COS Filter 3, to set up the filter mask for PCD 3. When operating in COS (Change-Of-State), this function filters out bits in PCD 3 that should not be sent if they change.

**10-23 COS Filter 4****Range:**

0\* [0 - 65535 ]

**Function:**

Enter the value for COS Filter 4 to set up the filter mask for PCD 4. When operating in COS (Change-Of-State), this function filters out bits in PCD 4 that should not be sent if they change.

**2.11.5 10-3\* Parameter Access**

Parameter group providing access to indexed parameters and defining programming set-up.

**10-30 Array Index****Range:**

0\* [0 - 255 ]

**Function:**

View array parameters. This parameter is valid only when a DeviceNet fieldbus is installed.

**10-31 Store Data Values****Option:**

**Function:**  
Parameter values changed via DeviceNet are not automatically stored in non-volatile memory. Use this parameter to activate a function that stores parameter values in the EEPROM non-volatile memory, so changed parameter values will be retained at power-down.

[0] \* Off

Deactivates the non-volatile storage function.

[1] Store edit setup

Stores all parameter values from the active set-up in the non-volatile memory. The selection returns to Off [0] when all values have been stored.

[2] Store all setups

Stores all parameter values for all set-ups in the non-volatile memory. The selection returns to Off [0] when all parameter values have been stored.

**10-32 Devicenet Revision****Range:**Application [0 - 65535 ]  
dependent\***Function:**

View the DeviceNet revision number. This parameter is used for EDS file creation.

**10-33 Store Always****Option:**

[0] \* Off

**Function:**

Deactivates non-volatile storage of data.

[1] On

Stores parameter data received via DeviceNet in EEPROM non-volatile memory as default.

**10-39 Devicenet F Parameters**

Array [1000]  
No LCP access

**Range:**

0\* [0 - 0 ]

**Function:**

This parameter is used to configure the frequency converter via DeviceNet and build the EDS-file.

**2**

## 2.11 Main Menu - Smart Logic - Group 13

### 2.12.1 13-\*\* Prog. Features Prog. Features

2

Smart Logic Control (SLC) is essentially a sequence of user defined actions (see par. 13-52 *SL Controller Action [x]*) executed by the SLC when the associated user defined *event* (see par. 13-51 *SL Controller Event [x]*) is evaluated as TRUE by the SLC. Events and *actions* are each numbered and linked together in pairs. This means that when *event* [0] is fulfilled (attains the value TRUE), *action* [0] is executed. After this, the conditions of *event* [1] will be evaluated and if evaluated TRUE, *action* [1] will be executed and so on. Only one *event* will be evaluated at any time. If an *event* is evaluated as FALSE, nothing happens (in the SLC) during the current scan interval and no other *events* will be evaluated. This means that when the SLC starts, it evaluates *event* [0] (and only *event* [0]) each scan interval. Only when *event* [0] is evaluated TRUE, will the SLC execute *action* [0] and start evaluating *event* [1]. It is possible to programme from 1 to 20 *events* and *actions*.

When the last *event / action* has been executed, the sequence starts over again from *event* [0] / *action* [0]. The illustration shows an example with three event / actions:

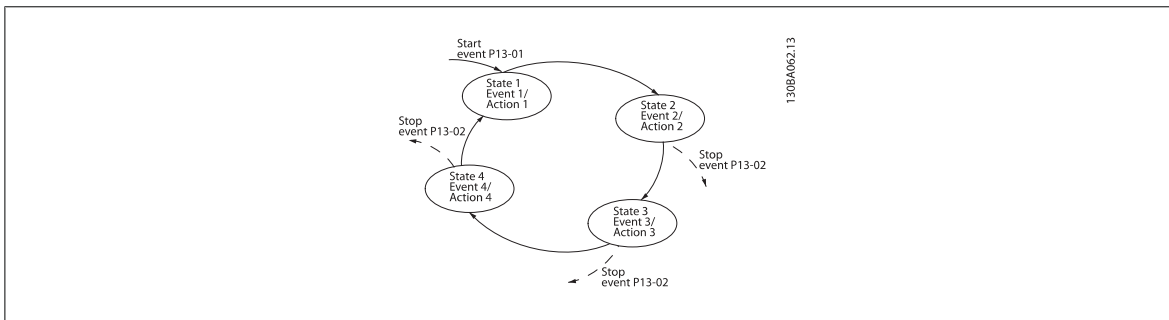

#### Starting and stopping the SLC:

Starting and stopping the SLC can be done by selecting *On* [1] or *Off* [0] in par. 13-00 *SL Controller Mode*. The SLC always starts in state 0 (where it evaluates *event* [0]). The SLC starts when the Start Event (defined in par. 13-01 *Start Event*) is evaluated as TRUE (provided that *On* [1] is selected in par. 13-00 *SL Controller Mode*). The SLC stops when the *Stop Event* (par. 13-02 *Stop Event*) is TRUE. par. 13-03 *Reset SLC* resets all SLC parameters and starts programming from scratch.

### 2.12.2 13-0\* SLCLC-0# LC Settings

Use the SLC settings to activate, deactivate and reset the Smart Logic Control.

#### 13-00 SL Controller Mode

Option:	Function:
[0] * Off	Disables the Smart Logic Controller.
[1] On	Enables the Smart Logic Controller.

#### 13-01 Start Event

Option:	Function:
	Select the boolean (TRUE or FALSE) input to activate Smart Logic Control.
[0] * False	Enters the fixed value of FALSE in the logic rule.
[1] True	Enters the fixed value TRUE in the logic rule.
[2] Running	See parameter group 5-3* for further description.
[3] In range	See parameter group 5-3* for further description.

[4]	On reference	See parameter group 5-3* for further description.
[5]	Torque limit	See parameter group 5-3* for further description.
[6]	Current limit	See parameter group 5-3* for further description.
[7]	Out of current range	See parameter group 5-3* for further description.
[8]	Below I low	See parameter group 5-3* for further description.
[9]	Above I high	See parameter group 5-3* for further description.
[10]	Out of speed range	
[11]	Below speed low	See parameter group 5-3* for further description.
[12]	Above speed high	See parameter group 5-3* for further description.
[13]	Out of feedb. range	
[14]	Below feedb. low	
[15]	Above feedb. high	
[16]	Thermal warning	See parameter group 5-3* for further description.
[17]	Mains out of range	See parameter group 5-3* for further description.
[18]	Reversing	See parameter group 5-3* for further description.
[19]	Warning	See parameter group 5-3* for further description.
[20]	Alarm (trip)	See parameter group 5-3* for further description.
[21]	Alarm (trip lock)	See parameter group 5-3* for further description.
[22]	Comparator 0	Use the result of comparator 0 in the logic rule.
[23]	Comparator 1	Use the result of comparator 1 in the logic rule.
[24]	Comparator 2	Use the result of comparator 2 in the logic rule.
[25]	Comparator 3	Use the result of comparator 3 in the logic rule.
[26]	Logic rule 0	Use the result of logic rule 0 in the logic rule.
[27]	Logic rule 1	Use the result of logic rule 1 in the logic rule.
[28]	Logic rule 2	Use the result of logic rule 2 in the logic rule.
[29]	Logic rule 3	Use the result of logic rule 3 in the logic rule.
[33]	Digital input DI18	Use the value of DI18 in the logic rule (High = TRUE).
[34]	Digital input DI19	Use the value of DI19 in the logic rule (High = TRUE).
[35]	Digital input DI27	Use the value of DI27 in the logic rule (High = TRUE).
[36]	Digital input DI29	Use the value of DI29 in the logic rule (High = TRUE).
[37]	Digital input DI32	Use the value of DI32 in the logic rule (High = TRUE).
[38]	Digital input DI33	Use the value of DI33 in the logic rule (High = TRUE).
[39]	Start command	This event is TRUE if the frequency converter is started by any means (either via digital input, field bus or other).
[40]	Drive stopped	This event is TRUE if the frequency converter is stopped or coasted by any means (either via digital input, fieldbus or other).

[41]	Reset Trip	This event is TRUE if the frequency converter is tripped (but not trip-locked) and the reset button is pressed.
[42]	Auto Reset Trip	This event is TRUE if the frequency converter is tripped (but not trip-locked) and an Automatic Reset is issued.
[43]	OK Key	This event is TRUE if the OK key on the LCP is pressed.
[44]	Reset Key	This event is TRUE if the Reset key on the LCP is pressed.
[45]	Left Key	This event is TRUE if the Left key on the LCP is pressed.
[46]	Right Key	This event is TRUE if the Right key on the LCP is pressed.
[47]	Up Key	This event is TRUE if the Up key on the LCP is pressed.
[48]	Down Key	This event is TRUE if the Down key on the LCP is pressed.
[50]	Comparator 4	Use the result of comparator 4 in the logic rule.
[51]	Comparator 5	Use the result of comparator 5 in the logic rule.
[60]	Logic rule 4	Use the result of logic rule 4 in the logic rule.
[61]	Logic rule 5	Use the result of logic rule 5 in the logic rule.

### 13-02 Stop Event

Option:		Function:
		Select the boolean (TRUE or FALSE) input to deactivate Smart Logic Control.
[0] *	False	Enters the fixed value of FALSE in the logic rule.
[1]	True	Enters the fixed value TRUE in the logic rule.
[2]	Running	See parameter group 5-3* for further description.
[3]	In range	See parameter group 5-3* for further description.
[4]	On reference	See parameter group 5-3* for further description.
[5]	Torque limit	See parameter group 5-3* for further description.
[6]	Current limit	See parameter group 5-3* for further description.
[7]	Out of current range	See parameter group 5-3* for further description.
[8]	Below I low	See parameter group 5-3* for further description.
[9]	Above I high	See parameter group 5-3* for further description.
[10]	Out of speed range	
[11]	Below speed low	See parameter group 5-3* for further description.
[12]	Above speed high	See parameter group 5-3* for further description.
[13]	Out of feedb. range	See parameter group 5-3* for further description.
[14]	Below feedb. low	See parameter group 5-3* for further description.
[15]	Above feedb. high	See parameter group 5-3* for further description.
[16]	Thermal warning	See parameter group 5-3* for further description.
[17]	Mains out of range	See parameter group 5-3* for further description.
[18]	Reversing	See parameter group 5-3* for further description.

[19]	Warning	See parameter group 5-3* for further description.
[20]	Alarm (trip)	See parameter group 5-3* for further description.
[21]	Alarm (trip lock)	See parameter group 5-3* for further description.
[22]	Comparator 0	Use the result of comparator 0 in the logic rule.
[23]	Comparator 1	Use the result of comparator 1 in the logic rule.
[24]	Comparator 2	Use the result of comparator 2 in the logic rule.
[25]	Comparator 3	Use the result of comparator 3 in the logic rule.
[26]	Logic rule 0	Use the result of logic rule 0 in the logic rule.
[27]	Logic rule 1	Use the result of logic rule 1 in the logic rule.
[28]	Logic rule 2	Use the result of logic rule 2 in the logic rule.
[29]	Logic rule 3	Use the result of logic rule 3 in the logic rule.
[30]	SL Time-out 0	Use the result of timer 0 in the logic rule.
[31]	SL Time-out 1	Use the result of timer 1 in the logic rule.
[32]	SL Time-out 2	Use the result of timer 2 in the logic rule.
[33]	Digital input DI18	Use the value of DI18 in the logic rule (High = TRUE).
[34]	Digital input DI19	Use the value of DI19 in the logic rule (High = TRUE).
[35]	Digital input DI27	Use the value of DI27 in the logic rule (High = TRUE).
[36]	Digital input DI29	Use the value of DI29 in the logic rule (High = TRUE).
[37]	Digital input DI32	Use the value of DI32 in the logic rule (High = TRUE).
[38]	Digital input DI33	Use the value of DI33 in the logic rule (High = TRUE).
[39]	Start command	This event is TRUE if the frequency converter is started by any means (either via digital input, fieldbus or other).
[40]	Drive stopped	This event is TRUE if the frequency converter is stopped or coasted by any means (either via digital input, fieldbus or other).
[41]	Reset Trip	This event is TRUE if the frequency converter is tripped (but not trip-locked) and the reset button is pressed.
[42]	Auto Reset Trip	This event is TRUE if the frequency converter is tripped (but not trip-locked) and an Automatic Reset is issued.
[43]	OK Key	This event is TRUE if the OK key on the LCP is pressed.
[44]	Reset Key	This event is TRUE if the Reset key on the LCP is pressed.
[45]	Left Key	This event is TRUE if the Left key on the LCP is pressed.
[46]	Right Key	This event is TRUE if the Right key on the LCP is pressed.
[47]	Up Key	This event is TRUE if the Up key on the LCP is pressed.
[48]	Down Key	This event is TRUE if the Down key on the LCP is pressed.
[50]	Comparator 4	Use the result of comparator 4 in the logic rule.
[51]	Comparator 5	Use the result of comparator 5 in the logic rule.

[60]	Logic rule 4	Use the result of logic rule 4 in the logic rule.
[61]	Logic rule 5	Use the result of logic rule 5 in the logic rule.
[70]	SL Time-out 3	Use the result of timer 3 in the logic rule.
[71]	SL Time-out 4	Use the result of timer 4 in the logic rule.
[72]	SL Time-out 5	Use the result of timer 5 in the logic rule.
[73]	SL Time-out 6	Use the result of timer 6 in the logic rule.
[74]	SL Time-out 7	Use the result of timer 7 in the logic rule.
[80]	No Flow	
[81]	Dry Pump	
[82]	End of Curve	
[83]	Broken Belt	

### 13-03 Reset SLC

**Option:**
**Function:**

[0] *	Do not reset SLC	Retains programmed settings in all group 13 parameters (13-*).
[1]	Reset SLC	Resets all group 13 parameters (13-*) to default settings.

### 2.12.3 13-1\* Comparators

Comparators are used for comparing continuous variables (i.e. output frequency, output current, analog input etc.) to fixed preset values. In addition, there are digital values that will be compared to fixed time values. See explanation in par. 13-10 *Comparator Operand*. Comparators are evaluated once in each scan interval. Use the result (TRUE or FALSE) directly. All parameters in this parameter group are array parameters with index 0 to 5. Select index 0 to programme Comparator 0, select index 1 to programme Comparator 1, and so on.

### 13-10 Comparator Operand

Array [4]

**Option:**
**Function:**

		Select the variable to be monitored by the comparator.
[0] *	DISABLED	
[1]	Reference	
[2]	Feedback	
[3]	Motor speed	
[4]	Motor current	
[5]	Motor torque	
[6]	Motor power	
[7]	Motor voltage	
[8]	DC-link voltage	
[9]	Motor thermal	
[10]	Drive thermal	
[11]	Heat sink temp.	
[12]	Analog input AI53	
[13]	Analog input AI54	
[14]	Analog input AIFB10	

[15]	Analog input AIS24V
[17]	Analog input AICCT
[18]	Pulse input FI29
[19]	Pulse input FI33
[20]	Alarm number
[30]	Counter A
[31]	Counter B

**13-11 Comparator Operator**

Array [6]

Option:	Function:
[0] * <	Select < [0] for the result of the evaluation to be TRUE, when the variable selected in par. 13-10 <i>Comparator Operand</i> is smaller than the fixed value in par. 13-12 <i>Comparator Value</i> . The result will be FALSE, if the variable selected in par. 13-10 <i>Comparator Operand</i> is greater than the fixed value in par. 13-12 <i>Comparator Value</i> .
[1] ≈ (equal)	Select ≈ [1] for the result of the evaluation to be TRUE, when the variable selected in par. 13-10 <i>Comparator Operand</i> is approximately equal to the fixed value in par. 13-12 <i>Comparator Value</i> .
[2] >	Select > [2] for the inverse logic of option < [0].

**13-12 Comparator Value**

Array [6]

Range:	Function:
Application [-100000.000 - 100000.000 ] dependent*	Enter the 'trigger level' for the variable that is monitored by this comparator. This is an array parameter containing comparator values 0 to 5.

**2.12.4 13-2\* Timers**

This parameter group consists of timer parameters.  
 Use the result (TRUE or FALSE) from *timers* directly to define an *event* (see par. 13-51 *SL Controller Event*), or as boolean input in a *logic rule* (see par. 13-40 *Logic Rule Boolean 1*, par. 13-42 *Logic Rule Boolean 2* or par. 13-44 *Logic Rule Boolean 3*). A timer is only FALSE when started by an action (i.e. Start timer 1 [29]) until the timer value entered in this parameter is elapsed. Then it becomes TRUE again.  
 All parameters in this parameter group are array parameters with index 0 to 2. Select index 0 to program Timer 0, select index 1 to program Timer 1, and so on.

**13-20 SL Controller Timer**

Array [3]

Range:	Function:
Application [Application dependant] dependent*	

**2.12.5 13-4\* Logic Rules**

Combine up to three boolean inputs (TRUE / FALSE inputs) from timers, comparators, digital inputs, status bits and events using the logical operators AND, OR, and NOT. Select boolean inputs for the calculation in par. 13-40 *Logic Rule Boolean 1*, par. 13-42 *Logic Rule Boolean 2* and par. 13-44 *Logic Rule Boolean 3*. Define the operators used to logically combine the selected inputs in par. 13-41 *Logic Rule Operator 1* and par. 13-43 *Logic Rule Operator 2*.

**Priority of calculation**

The results of par. 13-40 *Logic Rule Boolean 1*, par. 13-41 *Logic Rule Operator 1* and par. 13-42 *Logic Rule Boolean 2* are calculated first. The outcome (TRUE / FALSE) of this calculation is combined with the settings of par. 13-43 *Logic Rule Operator 2* and par. 13-44 *Logic Rule Boolean 3*, yielding the final result (TRUE / FALSE) of the logic rule.

**2**

**13-40 Logic Rule Boolean 1**

Array [6]

<b>Option:</b>	<b>Function:</b>
[0] * False	Enters the fixed value of FALSE in the logic rule.
[1] True	Enters the fixed value TRUE in the logic rule.
[2] Running	See parameter group 5-3* for further description.
[3] In range	See parameter group 5-3* for further description.
[4] On reference	See parameter group 5-3* for further description.
[5] Torque limit	See parameter group 5-3* for further description.
[6] Current limit	See parameter group 5-3* for further description.
[7] Out of current range	See parameter group 5-3* for further description.
[8] Below I low	See parameter group 5-3* for further description.
[9] Above I high	See parameter group 5-3* for further description.
[10] Out of speed range	
[11] Below speed low	See parameter group 5-3* for further description.
[12] Above speed high	See parameter group 5-3* for further description.
[13] Out of feedb. range	See parameter group 5-3* for further description.
[14] Below feedb. low	See parameter group 5-3* for further description.
[15] Above feedb. high	See parameter group 5-3* for further description.
[16] Thermal warning	See parameter group 5-3* for further description.
[17] Mains out of range	See parameter group for further description.
[18] Reversing	See parameter group 5-3* for further description.
[19] Warning	See parameter group 5-3* for further description.
[20] Alarm (trip)	See parameter group 5-3* for further description.
[21] Alarm (trip lock)	See parameter group 5-3* for further description.
[22] Comparator 0	Use the result of comparator 0 in the logic rule.
[23] Comparator 1	Use the result of comparator 1 in the logic rule.
[24] Comparator 2	Use the result of comparator 2 in the logic rule.
[25] Comparator 3	Use the result of comparator 3 in the logic rule.
[26] Logic rule 0	Use the result of logic rule 0 in the logic rule.
[27] Logic rule 1	Use the result of logic rule 1 in the logic rule.
[28] Logic rule 2	Use the result of logic rule 2 in the logic rule.
[29] Logic rule 3	Use the result of logic rule 3 in the logic rule.
[30] SL Time-out 0	Use the result of timer 0 in the logic rule.
[31] SL Time-out 1	Use the result of timer 1 in the logic rule.
[32] SL Time-out 2	Use the result of timer 2 in the logic rule.

[33]	Digital input DI18	Use the value of DI18 in the logic rule (High = TRUE).
[34]	Digital input DI19	Use the value of DI19 in the logic rule (High = TRUE).
[35]	Digital input DI27	Use the value of DI27 in the logic rule (High = TRUE).
[36]	Digital input DI29	Use the value of DI29 in the logic rule (High = TRUE).
[37]	Digital input DI32	Use the value of DI32 in the logic rule (High = TRUE).
[38]	Digital input DI33	Use the value of DI33 in the logic rule (High = TRUE).
[39]	Start command	This logic rule is TRUE if the frequency converter is started by any means (either via digital input, field bus or other).
[40]	Drive stopped	This logic rule is TRUE if the frequency converter is stopped or coasted by any means (either via digital input, fieldbus or other).
[41]	Reset Trip	This logic rule is TRUE if the frequency converter is tripped (but not trip-locked) and the reset button is pressed.
[42]	Auto Reset Trip	This logic rule is TRUE if the frequency converter is tripped (but not trip-locked) and an Automatic Reset is issued.
[43]	OK Key	This logic rule is TRUE if the OK key on the LCP is pressed.
[44]	Reset Key	This logic rule is TRUE if the Reset key on the LCP is pressed.
[45]	Left Key	This logic rule is TRUE if the Left key on the LCP is pressed.
[46]	Right Key	This logic rule is TRUE if the Right key on the LCP is pressed.
[47]	Up Key	This logic rule is TRUE if the Up key on the LCP is pressed.
[48]	Down Key	This logic rule is TRUE if the Down key on the LCP is pressed.
[50]	Comparator 4	Use the result of comparator 4 in the logic rule.
[51]	Comparator 5	Use the result of comparator 5 in the logic rule.
[60]	Logic rule 4	Use the result of logic rule 4 in the logic rule.
[61]	Logic rule 5	Use the result of logic rule 5 in the logic rule.
[70]	SL Time-out 3	Use the result of timer 3 in the logic rule.
[71]	SL Time-out 4	Use the result of timer 4 in the logic rule.
[72]	SL Time-out 5	Use the result of timer 5 in the logic rule.
[73]	SL Time-out 6	Use the result of timer 6 in the logic rule.
[74]	SL Time-out 7	Use the result of timer 7 in the logic rule.
[80]	No Flow	
[81]	Dry Pump	
[82]	End of Curve	
[83]	Broken Belt	

### 13-41 Logic Rule Operator 1

Array [6]

**Option:**

**Function:**

Select the first logical operator to use on the Boolean inputs from par. 13-40 *Logic Rule Boolean 1* and par. 13-42 *Logic Rule Boolean 2*.  
[13 -XX] signifies the boolean input of par. 13-\*.

[0] *	DISABLED	Ignores par. , par. 13-43 <i>Logic Rule Operator 2</i> , and par. 13-44 <i>Logic Rule Boolean 3</i> .
[1]	AND	Evaluates the expression [13-40] AND [13-42].
[2]	OR	evaluates the expression [13-40] OR [13-42].
[3]	AND NOT	evaluates the expression [13-40] AND NOT [13-42].
[4]	OR NOT	evaluates the expression [13-40] OR NOT [13-42].
[5]	NOT AND	evaluates the expression NOT [13-40] AND [13-42].
[6]	NOT OR	evaluates the expression NOT [13-40] OR [13-42].
[7]	NOT AND NOT	evaluates the expression NOT [13-40] AND NOT [13-42].
[8]	NOT OR NOT	evaluates the expression NOT [13-40] OR NOT [13-42].

### 13-42 Logic Rule Boolean 2

Array [6]

**Option:**

**Function:**

Select the second boolean (TRUE or FALSE) input for the selected logic rule.  
See par. 13-40 *Logic Rule Boolean 1* for further descriptions of choices and their functions.

[0] *	False
[1]	True
[2]	Running
[3]	In range
[4]	On reference
[5]	Torque limit
[6]	Current limit
[7]	Out of current range
[8]	Below I low
[9]	Above I high
[10]	Out of speed range
[11]	Below speed low
[12]	Above speed high
[13]	Out of feedb. range
[14]	Below feedb. low
[15]	Above feedb. high
[16]	Thermal warning
[17]	Mains out of range
[18]	Reversing
[19]	Warning
[20]	Alarm (trip)

## 2

[21]	Alarm (trip lock)
[22]	Comparator 0
[23]	Comparator 1
[24]	Comparator 2
[25]	Comparator 3
[26]	Logic rule 0
[27]	Logic rule 1
[28]	Logic rule 2
[29]	Logic rule 3
[30]	SL Time-out 0
[31]	SL Time-out 1
[32]	SL Time-out 2
[33]	Digital input DI18
[34]	Digital input DI19
[35]	Digital input DI27
[36]	Digital input DI29
[37]	Digital input DI32
[38]	Digital input DI33
[39]	Start command
[40]	Drive stopped
[41]	Reset Trip
[42]	Auto Reset Trip
[43]	OK Key
[44]	Reset Key
[45]	Left Key
[46]	Right Key
[47]	Up Key
[48]	Down Key
[50]	Comparator 4
[51]	Comparator 5
[60]	Logic rule 4
[61]	Logic rule 5
[70]	SL Time-out 3
[71]	SL Time-out 4
[72]	SL Time-out 5
[73]	SL Time-out 6
[74]	SL Time-out 7
[80]	No Flow
[81]	Dry Pump
[82]	End of Curve
[83]	Broken Belt

### 13-43 Logic Rule Operator 2

Array [6]

**Option:**

**Function:**

Select the second logical operator to be used on the boolean input calculated in par. 13-40 *Logic Rule Boolean 1*, par. 13-41 *Logic Rule Operator 1*, and par. 13-42 *Logic Rule Boolean 2*, and the boolean input coming from par. 13-42 *Logic Rule Boolean 2*.

[13-44] signifies the boolean input of par. 13-44 *Logic Rule Boolean 3*.

[13-40/13-42] signifies the boolean input calculated in par. 13-40 *Logic Rule Boolean 1*, par. 13-41 *Logic Rule Operator 1*, and par. 13-42 *Logic Rule Boolean 2*. DISABLED [0] (factory setting). select this option to ignore par. 13-44 *Logic Rule Boolean 3*.

[0] \* DISABLED

[1] AND

[2] OR

[3] AND NOT

[4] OR NOT

[5] NOT AND

[6] NOT OR

[7] NOT AND NOT

[8] NOT OR NOT

### 13-44 Logic Rule Boolean 3

Array [6]

**Option:**

**Function:**

Select the third boolean (TRUE or FALSE) input for the selected logic rule.

See par. 13-40 *Logic Rule Boolean 1* for further descriptions of choices and their functions.

[0] \* False

[1] True

[2] Running

[3] In range

[4] On reference

[5] Torque limit

[6] Current limit

[7] Out of current range

[8] Below I low

[9] Above I high

[10] Out of speed range

[11] Below speed low

[12] Above speed high

[13] Out of feedb. range

[14] Below feedb. low

[15] Above feedb. high

[16] Thermal warning

[17] Mains out of range

[18] Reversing

[19] Warning

## 2

[20]	Alarm (trip)
[21]	Alarm (trip lock)
[22]	Comparator 0
[23]	Comparator 1
[24]	Comparator 2
[25]	Comparator 3
[26]	Logic rule 0
[27]	Logic rule 1
[28]	Logic rule 2
[29]	Logic rule 3
[30]	SL Time-out 0
[31]	SL Time-out 1
[32]	SL Time-out 2
[33]	Digital input DI18
[34]	Digital input DI19
[35]	Digital input DI27
[36]	Digital input DI29
[37]	Digital input DI32
[38]	Digital input DI33
[39]	Start command
[40]	Drive stopped
[41]	Reset Trip
[42]	Auto Reset Trip
[43]	OK Key
[44]	Reset Key
[45]	Left Key
[46]	Right Key
[47]	Up Key
[48]	Down Key
[50]	Comparator 4
[51]	Comparator 5
[60]	Logic rule 4
[61]	Logic rule 5
[70]	SL Time-out 3
[71]	SL Time-out 4
[72]	SL Time-out 5
[73]	SL Time-out 6
[74]	SL Time-out 7
[80]	No Flow
[81]	Dry Pump
[82]	End of Curve
[83]	Broken Belt

### 2.12.6 13-5\* States

Parameters for programming the Smart Logic Controller.

#### 13-51 SL Controller Event

Array [20]

**Option:**

**Function:**

Select the boolean input (TRUE or FALSE) to define the Smart Logic Controller event.  
See par. 13-02 *Stop Event* for further descriptions of choices and their functions.

- [0] \* False
- [1] True
- [2] Running
- [3] In range
- [4] On reference
- [5] Torque limit
- [6] Current limit
- [7] Out of current range
- [8] Below I low
- [9] Above I high
- [10] Out of speed range
- [11] Below speed low
- [12] Above speed high
- [13] Out of feedb. range
- [14] Below feedb. low
- [15] Above feedb. high
- [16] Thermal warning
- [17] Mains out of range
- [18] Reversing
- [19] Warning
- [20] Alarm (trip)
- [21] Alarm (trip lock)
- [22] Comparator 0
- [23] Comparator 1
- [24] Comparator 2
- [25] Comparator 3
- [26] Logic rule 0
- [27] Logic rule 1
- [28] Logic rule 2
- [29] Logic rule 3
- [30] SL Time-out 0
- [31] SL Time-out 1
- [32] SL Time-out 2
- [33] Digital input DI18
- [34] Digital input DI19

[35]	Digital input DI27
[36]	Digital input DI29
[37]	Digital input DI32
[38]	Digital input DI33
[39]	Start command
[40]	Drive stopped
[41]	Reset Trip
[42]	Auto Reset Trip
[43]	OK Key
[44]	Reset Key
[45]	Left Key
[46]	Right Key
[47]	Up Key
[48]	Down Key
[50]	Comparator 4
[51]	Comparator 5
[60]	Logic rule 4
[61]	Logic rule 5
[70]	SL Time-out 3
[71]	SL Time-out 4
[72]	SL Time-out 5
[73]	SL Time-out 6
[74]	SL Time-out 7
[80]	No Flow
[81]	Dry Pump
[82]	End of Curve
[83]	Broken Belt

### 13-52 SL Controller Action

Array [20]

#### Option:

#### Function:

Select the action corresponding to the SLC event. Actions are executed when the corresponding event (defined in par. 13-51 *SL Controller Event*) is evaluated as true. The following actions are available for selection:

[0] *	Disabled	
[1]	No action	
[2]	Select set-up 1	Changes the active set-up (par. 0-10 <i>Active Set-up</i> ) to '1'.
[3]	Select set-up 2	Changes the active set-up (par. 0-10 <i>Active Set-up</i> ) to '2'.
[4]	Select set-up 3	Changes the active set-up (par. 0-10 <i>Active Set-up</i> ) to '3'.
[5]	Select set-up 4	Changes the active set-up (par. 0-10 <i>Active Set-up</i> ) to '4'. If the set-up is changed, it will merge with other set-up commands coming from either the digital inputs or via a fieldbus.
[10]	Select preset ref 0	Selects preset reference 0.
[11]	Select preset ref 1	Selects preset reference 1.

[12]	Select preset ref 2	Selects preset reference 2.
[13]	Select preset ref 3	Selects preset reference 3.
[14]	Select preset ref 4	Selects preset reference 4.
[15]	Select preset ref 5	Selects preset reference 5.
[16]	Select preset ref 6	Selects preset reference 6.
[17]	Select preset ref 7	Selects preset reference 7. If the active preset reference is changed, it will merge with other preset reference commands coming from either the digital inputs or via a fieldbus.
[18]	Select ramp 1	Selects ramp 1
[19]	Select ramp 2	Selects ramp 2
[22]	Run	Issues a start command to the frequency converter.
[23]	Run reverse	Issues a start reverse command to the frequency converter.
[24]	Stop	Issues a stop command to the frequency converter.
[26]	DC Brake	Issues a DC stop command to the frequency converter.
[27]	Coast	The frequency converter coasts immediately. All stop commands including the coast command stop the SLC.
[28]	Freeze output	Freezes the output frequency of the frequency converter.
[29]	Start timer 0	Starts timer 0, see par. 13-20 <i>SL Controller Timer</i> for further description.
[30]	Start timer 1	Starts timer 1, see par. 13-20 <i>SL Controller Timer</i> for further description.
[31]	Start timer 2	Starts timer 2, see par. 13-20 <i>SL Controller Timer</i> for further description.
[32]	Set digital out A low	Any output with 'digital output 1' selected is low (off).
[33]	Set digital out B low	Any output with 'digital output 2' selected is low (off).
[34]	Set digital out C low	Any output with 'digital output 3' selected is low (off).
[35]	Set digital out D low	Any output with 'digital output 4' selected is low (off).
[36]	Set digital out E low	Any output with 'digital output 5' selected is low (off).
[37]	Set digital out F low	Any output with 'digital output 6' selected is low (off).
[38]	Set digital out A high	Any output with 'digital output 1' selected is high (closed).
[39]	Set digital out B high	Any output with 'digital output 2' selected is high (closed).
[40]	Set digital out C high	Any output with 'digital output 3' selected is high (closed).
[41]	Set digital out D high	Any output with 'digital output 4' selected is high (closed).
[42]	Set digital out E high	Any output with 'digital output 5' selected is high (closed).
[43]	Set digital out F high	Any output with 'digital output 6' selected is high (closed).
[60]	Reset Counter A	Resets Counter A to zero.
[61]	Reset Counter B	Resets Counter A to zero.
[70]	Start Timer 3	Starts timer 3, see par. 13-20 <i>SL Controller Timer</i> for further description.
[71]	Start Timer 4	Starts timer 4, see par. 13-20 <i>SL Controller Timer</i> for further description.
[72]	Start Timer 5	Starts timer 5, see par. 13-20 <i>SL Controller Timer</i> for further description.

[73]	Start Timer 6	Starts timer 6, see par. 13-20 <i>SL Controller Timer</i> for further description.
[74]	Start Timer 7	Starts timer 7, see par. 13-20 <i>SL Controller Timer</i> for further description.
[80]	Sleep Mode	

# 2

## 2.12 Main Menu - Special Functions - Group 14

### 2.13.1 14-\*\* Special Functions

Parameter group for configuring special frequency converter functions.

### 2.13.2 Inverter Switching 14-0\*

Parameters for configuring the inverter switching.

#### 14-00 Switching Pattern

Option:	Function:
	Select the switching pattern: 60° AVM or SFAVM.
[0] *      60 AVM	
[1]            SFAVM	

#### 14-01 Switching Frequency

Option:	Function:
	Select the inverter switching frequency. Changing the switching frequency can help to reduce acoustic noise from the motor.



**NB!**

The output frequency value of the frequency converter must never exceed 1/10 of the switching frequency. When the motor is running, adjust the switching frequency in par. 14-01 *Switching Frequency* until the motor is as noiseless as possible. See also par. 14-00 *Switching Pattern* and the section *Derating*.

[0]            1.0 kHz
[1]            1.5 kHz
[2]            2.0 kHz
[3]            2.5 kHz
[4]            3.0 kHz
[5]            3.5 kHz
[6]            4.0 kHz
[7] *          5.0 kHz
[8]            6.0 kHz
[9]            7.0 kHz
[10]          8.0 kHz
[11]          10.0 kHz
[12]          12.0 kHz
[13]          14.0 kHz
[14]          16.0 kHz

2

**14-03 Overmodulation**

Option:	Function:
[0] Off	Selects no over-modulation of the output voltage in order to avoid torque ripple on the motor shaft.
[1] * On	The over-modulation function generates an extra voltage of up-to 8% of $U_{max}$ output voltage without over-modulation, which results in an extra torque of 10-12% in the middle of the over-synchronous range (from 0% at nominal speed rising to approximately 12% at double nominal speed).

**14-04 PWM Random**

Option:	Function:
[0] * Off	No change of the acoustic motor switching noise.
[1] On	Transforms the acoustic motor switching noise from a clear ringing tone to a less noticeable 'white' noise. This is achieved by slightly and randomly altering the synchronism of the pulse width modulated output phases.

**2.13.3 14-1\* Mains On/Off**

Parameters for configuring mains failure monitoring and handling.

**14-10 Mains Failure**

Option:	Function:
[0] * No function	Select the function at which the frequency converter must act, when the threshold set in par. 14-11 <i>Mains Voltage at Mains Fault</i> has been reached or a <i>Mains Failure Inverse</i> command is activated via one of the digital inputs (par. 5-1*).
[1] Ctrl. ramp-down	The energy left in the capacitor bank will be used to "drive" the motor, but will be discharged.
[3] Coasting	The frequency converter will perform a controlled ramp-down. par. 2-10 <i>Brake Function</i> must be set to <i>Off</i> [0].
[4] Kinetic back-up	The inverter will turn off and the capacitor bank will back up the control card then ensuring a faster restart when mains reconnected (at short power zags).
[4] Kinetic back-up	The frequency converter will ride through by controlling speed for generative operation of the motor utilizing the moment of inertia of the system as long as sufficient energy is present.



**NB!**

For best performance of controlled ramp-down and kinetic back-up par. 1-03 *Torque Characteristics* should be set to *Compressor* [0] or *Variable Torque* [1] (no automatic energy optimization should be active).

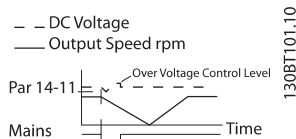
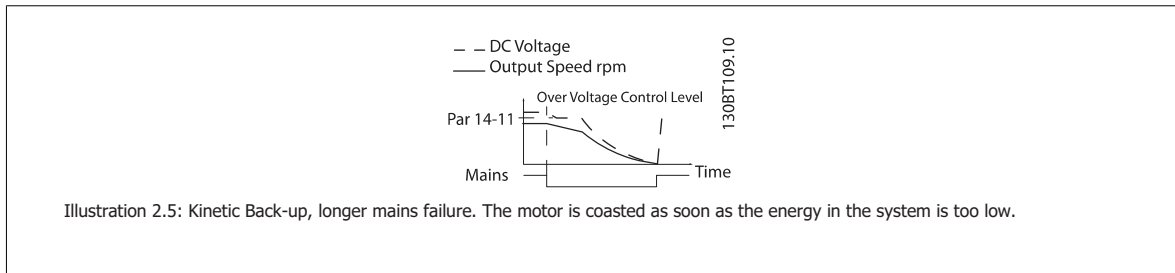
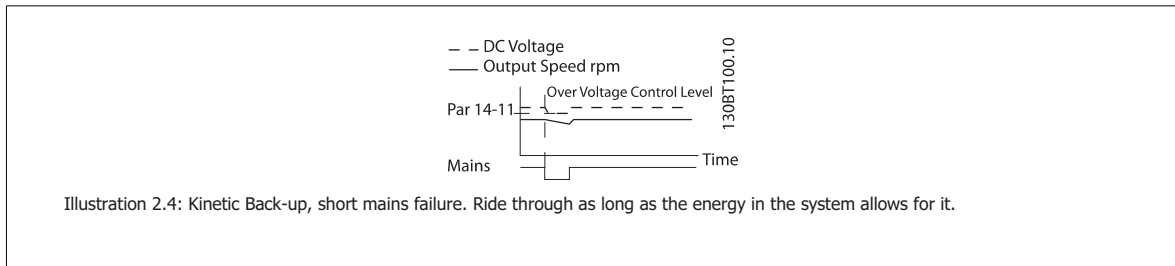
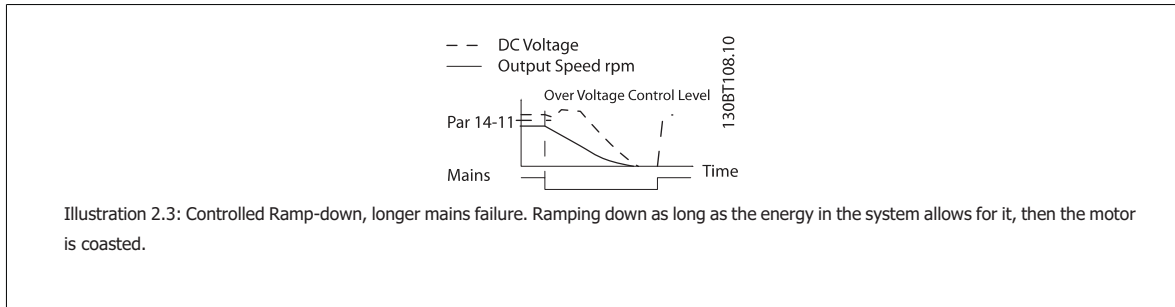

Illustration 2.2: Controlled Ramp-down - short mains failure. Ramping down to stop followed by ramping up to reference.



#### 14-11 Mains Voltage at Mains Fault

**Range:**

Application [180 - 600 V]  
dependent\*

**Function:**

This parameter defines the threshold voltage at which the selected function in par. 14-10 *Mains Failure* should be activated.

#### 14-12 Function at Mains Imbalance

**Option:**

**Function:**

Operation under severe main imbalance conditions reduces the lifetime of the motor. Conditions are considered severe if the motor is operated continuously near nominal load (e.g. a pump or fan running near full speed).

When a severe mains imbalance is detected:

- |       |          |  |
|-------|----------|--|
| [0] * | Trip     | Select <i>Trip</i> [0] to trip the frequency converter.        |
| [1]   | Warning  | Select <i>Warning</i> [1] to issue a warning.                  |
| [2]   | Disabled | Select <i>Disabled</i> [2] for no action.                      |
| [3] * | Derate   | Select <i>Derate</i> [3] for derating the frequency converter. |

### 2.13.4 14-2\* Trip Reset

Parameters for configuring auto reset handling, special trip handling and control card self test or initialisation.

**14-20 Reset Mode****Option:****Function:**

[0] Manual reset

[1] Automatic reset x 1

[2] Automatic reset x 2

[3] Automatic reset x 3

[4] Automatic reset x 4

[5] Automatic reset x 5

[6] Automatic reset x 6

[7] Automatic reset x 7

[8] Automatic reset x 8

[9] Automatic reset x 9

[10] \* Automatic reset x 10

[11] Automatic reset x 15

[12] Automatic reset x 20

[13] Infinite Automatic Reset

Select the reset function after tripping. Once reset, the frequency converter can be restarted.

Select *Manual reset* [0], to perform a reset via [RESET] or via the digital inputs.Select *Automatic reset x 1...x20* [1]-[12] to perform between one and twenty automatic resets after tripping.Select *Infinite Automatic Reset* [13] for continuous resetting after tripping.**NB!**

The motor may start without warning. If the specified number of AUTOMATIC RESETS is reached within 10 minutes, the frequency converter enters Manual reset [0] mode. After the Manual reset is performed, the setting of par. 14-20 reverts to the original selection. If the number of automatic resets is not reached within 10 minutes, or when a Manual reset is performed, the internal AUTOMATIC RESET counter returns to zero.

**14-21 Automatic Restart Time****Range:****Function:**

10 s\* [0 - 600 s]

Enter the time interval from trip to start of the automatic reset function. This parameter is active when par. 14-20 *Reset Mode* is set to *Automatic reset* [1] - [13].

**14-22 Operation Mode**

**Option:**

**Function:**

Use this parameter to specify normal operation, to perform tests or to initialise all parameters except par. 15-03 *Power Up's*, par. 15-04 *Over Temp's* and par. 15-05 *Over Volt's*. This function is active only when the power is cycled (power off-power on) to the frequency converter.

[0] \* Normal operation

Select *Normal operation* [0] for normal operation of the frequency converter with the motor in the selected application.

[1] Control card test

Select *Control card test* [1] to test the analog and digital inputs and outputs and the +10 V control voltage. The test requires a test connector with internal connections.

Use the following procedure for the control card test:

1. Select *Control card test* [1].
2. Disconnect the mains supply and wait for the light in the display to go out.
3. Set switches S201 (A53) and S202 (A54) = 'ON' / I.
4. Insert the test plug (see below).
5. Connect to mains supply.
6. Carry out various tests.
7. The results are displayed on the LCP and the frequency converter moves into an infinite loop.
8. par. 14-22 *Operation Mode* is automatically set to Normal operation. Carry out a power cycle to start up in Normal operation after a control card test.

**If the test is OK:**

LCP read-out: Control Card OK.

Disconnect the mains supply and remove the test plug. The green LED on the control card will light up.

**If the test fails:**

LCP read-out: Control Card I/O failure.

Replace the frequency converter or control card. The red LED on the control card is turned on. To test the plugs, connect/group the following terminals as shown below: (18 - 27 - 32), (19 - 29 - 33) and (42 - 53 - 54).

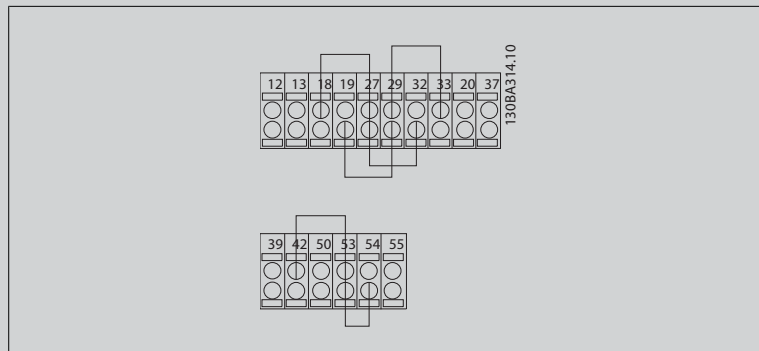

[2] Initialisation

Select *Initialization* [2] to reset all parameter values to default settings, except for par. 15-03 *Power Up's*, par. 15-04 *Over Temp's* and par. 15-05 *Over Volt's*. The frequency converter will reset during the next power-up.

par. 14-22 *Operation Mode* will also revert to the default setting *Normal operation* [0].

[3] Boot mode

**14-25 Trip Delay at Torque Limit****Range:**

60 s\* [0 - 60 s]

**Function:**

Enter the torque limit trip delay in seconds. When the output torque reaches the torque limits (par. 4-16 *Torque Limit Motor Mode* and par. 4-17 *Torque Limit Generator Mode*), a warning is triggered. When the torque limit warning has been continuously present for the period specified in this parameter, the frequency converter trips. Disable the trip delay by setting the parameter to 60 s = OFF. Thermal frequency converter monitoring will still remain active.

**14-26 Trip Delay at Inverter Fault****Range:**Application [0 - 35 s]  
dependent\***Function:**

When the frequency converter detects an over-voltage in the set time trip will be effected after the set time.

**14-29 Service Code****Range:**

0\* [-2147483647 - 2147483647 ]

**Function:**

Service use only.

**2.13.5 14-3\*Current Limit Control**

The frequency converter features an integral Current Limit Controller which is activated when the motor current, and thus the torque, is higher than the torque limits set in par. 4-16 and 4-17.

When the current limit is reached during motor operation or regenerative operation, the frequency converter will try to reduce torque below the preset torque limits as quickly as possible without losing control of the motor.

While the current control is active, the frequency converter can only be stopped by setting a digital input to *Coast inverse* [2] or *Coast and reset inv.* [3]. Any signal on terminals 18 to 33 will not be active until the frequency converter is no longer near the current limit.

By using a digital input set to *Coast inverse* [2] or *Coast and reset inv.* [3], the motor does not use the ramp-down time, since the frequency converter is coasted.

**14-30 Current Lim Ctrl, Proportional Gain****Range:**

100 %\* [5 - 500 %]

**Function:**

Enter the proportional gain value for the current limit controller. Selection of a high value makes the controller react faster. Too high a setting leads to controller instability.

**14-31 Current Lim Ctrl, Integration Time****Range:**

0.020 s\* [0.002 - 2.000 s]

**Function:**

Controls the current limit control integration time. Setting it to a lower value makes it react faster. A setting too low leads to control instability.

**14-32 Current Lim Ctrl, Filter Time****Range:**

27.0 ms\* [1.0 - 100.0 ms]

**Function:**

### 2.13.6 14-4\* Energy Optimising

Parameters for adjusting the energy optimisation level in both Variable Torque (VT) and Automatic Energy Optimization (AEO) mode.

Automatic Energy Optimisation is only active if par.1-03, Torque Characteristics, is set for either *Auto Energy Optim. CT* [2] or *Auto Energy Optim. VT* [3].

#### 14-40 VT Level

Range:	Function:
66 %* [40 - 90 %]	Enter the level of motor magnetisation at low speed. Selection of a low value reduces energy loss in the motor, but also reduces load capability. This parameter cannot be adjusted while the motor is running.

#### 14-41 AEO Minimum Magnetisation

Range:	Function:
Application [40 - 75 %] dependent*	Enter the minimum allowable magnetisation for AEO. Selection of a low value reduces energy loss in the motor, but can also reduce resistance to sudden load changes.

#### 14-42 Minimum AEO Frequency

Range:	Function:
10 Hz* [5 - 40 Hz]	Enter the minimum frequency at which the Automatic Energy Optimisation (AEO) is to be active.

#### 14-43 Motor Cosphi

Range:	Function:
0.66* [0.40 - 0.95]	The Cos(phi) setpoint is automatically set for optimum AEO performance during AMA. This parameter should normally not be altered. However in some situations it may be necessary to enter a new value to fine-tune.

### 2.13.7 14-5\* Environment

These parameters help the frequency converter to operate under special environmental conditions.

#### 14-50 RFI 1

Option:	Function:
[0] Off	Select <i>On</i> [1] to ensure the frequency converter complies with EMC standards. Select <i>Off</i> [0] only when the frequency converter is supplied from an isolated mains source, i.e. IT mains. In this mode, the internal RFI capacities (filter capacitors) between chassis and the Mains RFI Filter circuit are cut off to avoid damage to the intermediate circuit and to reduce the earth capacity currents (according to IEC 61800-3).
[1] * On	

**14-52 Fan Control****Option:****Function:**

Select the minimum speed of the main fan.

[0] \* Auto

Select Auto [0] to run the fan only when the internal temperature of the frequency converter is in the range +35°C to approximately +55°C. The fan will run at low speed at +35°C and at full speed at approximately +55°C.

[1] On 50%

[2] On 75%

[3] On 100%

[4] Auto (Low temp env.)

**14-53 Fan Monitor****Option:****Function:**

Select which reaction the frequency converter should take in case a fan fault is detected.

[0] Disabled

[1] \* Warning

[2] Trip

**14-53 Fan Monitor****Option:****Function:**

Select which reaction the frequency converter should take in case a fan fault is detected.

[0] Disabled

[1] \* Warning

[2] Trip

**2.13.8 14-6\* Auto Derate**

This group contains parameters for derating the frequency converter in case of high temperature.

**14-60 Function at Overtemperature****Option:****Function:**

[0] Trip

[1] \* Derate

If either heatsink or control card temperature exceeds a programmed temperature limit, a warning will be activated. If the temperature increases further, select whether the frequency converter should trip (trip locked) or derate the output current.

*Trip* [0]: The frequency converter will trip (trip locked) and generate an alarm. Power must be cycled to reset the alarm, but will not allow restart of the motor until the heat sink temperature has dropped below the alarm limit.

*Derate* [1]: If the critical temperature is exceeded the output current will be reduced until the allowable temperature has been reached.

### 2.13.9 No Trip at Inverter Overload

In some pump systems, the frequency converter has not been sized properly to yield the current needed in all points of the operational flow-head characteristic. At these points, the pump will need a current higher than the rated current of the frequency converter. The frequency converter can yield 110% of the rated current continuously for 60 sec. If still overloaded, the frequency converter will normally trip (causing the pump to stop by coasting) and provide an alarm.



It may be preferable to run the pump at reduced speed for a while in case it is not possible to run continuously with demanded capacity.

Select *Function at Inverter Overload*, par. 14-61 *Function at Inverter Overload* to automatically reduce pump speed until the output current is below 100% of the rated current (set in par. 14-62 *Inv. Overload Derate Current*).

The *Function at Inverter Overload* is an alternative to letting the frequency converter trip.

The frequency converter estimates the load on the power section by means of an inverter load counter, which will cause a warning at 98% and a reset of the warning at 90%. At the value 100%, the frequency converter trips and provides an alarm.

Status for the counter can be read in par. 16-35 *Inverter Thermal*.

If par. 14-61 *Function at Inverter Overload* is set to Derate, the pump speed will be reduced when the counter exceeds 98, and stay reduced until the counter has dropped below 90.7.

If par. 14-62 *Inv. Overload Derate Current* is set e.g. to 95% a steady overload will cause the pump speed to fluctuate between values corresponding to 110% and 95% of rated output current for the frequency converter.

#### 14-61 Function at Inverter Overload

Option:	Function:
[0] Trip	
[1] * Derate	Is used in case of steady overload beyond the thermal limits (110% for 60 sec.). Choose <i>Trip</i> [0] to make the frequency converter trip and provide an alarm or <i>Derate</i> [1] to reduce pump speed in order to decrease the load on the power section and allowing this to cool down.

#### 14-62 Inv. Overload Derate Current

Range:	Function:
95 %* [50 - 100 %]	Defines the desired current level (in % of rated output current for the frequency converter) when running with reduced pump speed after load on the frequency converter has exceeded the allowable limit (110% for 60 sec.).

## 2.13 Main Menu - Frequency Converter Information - Group 15

### 2.14.1 15-\*\* Drive Information

2

Parameter group containing frequency converter information such as operating data, hardware configuration and software versions.

### 2.14.2 15-0\* Operating Data

Parameter group containing operating data e.g. Operating Hours, kWh counters, Power Ups, etc.

#### 15-00 Operating Hours

**Range:**

0 h\* [0 - 2147483647 h]

**Function:**

View how many hours the frequency converter has run. The value is saved when the frequency converter is turned off.

#### 15-01 Running Hours

**Range:**

0 h\* [0 - 2147483647 h]

**Function:**

View how many hours the motor has run. Reset the counter in par. 15-07 *Reset Running Hours Counter*. The value is saved when the frequency converter is turned off.

#### 15-02 kWh Counter

**Range:**

0 kWh\* [0 - 2147483647 kWh]

**Function:**

Registering the power consumption of the motor as a mean value over one hour. Reset the counter in par. 15-06 *Reset kWh Counter*.

#### 15-03 Power Up's

**Range:**

0\* [0 - 2147483647 ]

**Function:**

View the number of times the frequency converter has been powered up.

#### 15-04 Over Temp's

**Range:**

0\* [0 - 65535 ]

**Function:**

View the number of frequency converter temperature faults which have occurred.

#### 15-05 Over Volt's

**Range:**

0\* [0 - 65535 ]

**Function:**

View the number of frequency converter overvoltages which have occurred.

#### 15-06 Reset kWh Counter

**Option:**

[0] \* Do not reset

**Function:**

Select *Do not reset* [0] if no reset of the kWh counter is desired.

[1] Reset counter

Select *Reset* [1] and press [OK] to reset the kWh counter to zero (see par. 15-02 *kWh Counter*).

**NB!**

The reset is carried out by pressing [OK].

### 15-07 Reset Running Hours Counter

Option:	Function:
[0] * Do not reset	Select <i>Do not reset</i> [0] if no reset of the Running Hours counter is desired.
[1] Reset counter	Select <i>Reset counter</i> [1] and press [OK] to reset the Running Hours counter (par. 15-01 <i>Running Hours</i> ) and par. 15-08 <i>Number of Starts</i> to zero (see also par. 15-01 <i>Running Hours</i> ).

### 15-08 Number of Starts

Range:	Function:
0* [0 - 2147483647 ]	This is a read out parameter only. The counter shows the numbers of starts and stops caused by a normal Start/Stop command and/or when entering/leaving sleep mode.

**NB!** This parameter will be reset when resetting par. 15-07 *Reset Running Hours Counter*.

## 2.14.3 15-1\* Data Log Settings

The Data Log enables continuous logging of up to 4 data sources (par. 15-10 *Logging Source*) at individual rates (par. 15-11 *Logging Interval*). A trigger event (par. 15-12 *Trigger Event*) and window (par. 15-14 *Samples Before Trigger*) are used to start and stop the logging conditionally.

### 15-10 Logging Source

Array [4]

Select which variables are to be logged.	
	None
[1600]	Control Word
[1601]	Reference [Unit]
[1602]	Reference %
[1603]	Status Word
[1610]	Power [kW]
[1611]	Power [hp]
[1612]	Motor Voltage
[1613]	Frequency
[1614]	Motor Current
[1616]	Torque [Nm]
[1617]	Speed [RPM]
[1618]	Thermal Motor Load
[1622]	Torque [%]
[1630]	DC Link Voltage
[1632]	Brake Energy / s
[1633]	Brake Energy / 2 min
[1634]	Heatsink Temp.
[1635]	Thermal Drive Load
[1650]	External Reference

## 2

[1652]	Feedback [Unit]
[1654]	Feedback 1 [Unit]
[1655]	Feedback 2 [Unit]
[1656]	Feedback 3 [Unit]
[1659]	Adjusted Setpoint
[1660]	Digital Input
[1662]	Analog Input 53
[1664]	Analog Input 54
[1665]	Analog Output 42 [mA]
[1666]	Digital Output [bin]
[1675]	Analog In X30/11
[1676]	Analog In X30/12
[1677]	Analog Out X30/8 [mA]
[1690]	Alarm Word
[1691]	Alarm Word 2
[1692]	Warning Word
[1693]	Warning Word 2
[1694]	Ext. Status Word
[1695]	Ext. Status Word 2
[1820]	Analog Input X42/1
[1821]	Analog Input X42/3
[1822]	Analog Input X42/5
[1823]	Analog Out X42/7 [mA]
[1824]	Analog Out X42/9 [mA]
[1825]	Analog Out X42/11 [mA]

**15-11 Logging Interval****Range:**Application [Application dependant]  
dependent\***Function:****15-12 Trigger Event****Option:****Function:**

Selects the trigger event. When the trigger event occurs, a window is applied to freeze the log. The log will then retain a specified percentage of samples before the occurrence of the trigger event (par. 15-14 *Samples Before Trigger*).

[0] *	False
[1]	True
[2]	Running
[3]	In range
[4]	On reference
[5]	Torque limit
[6]	Current limit
[7]	Out of current range
[8]	Below I low

[9]	Above I high
[10]	Out of speed range
[11]	Below speed low
[12]	Above speed high
[13]	Out of feedb. range
[14]	Below feedb. low
[15]	Above feedb. high
[16]	Thermal warning
[17]	Mains out of range
[18]	Reversing
[19]	Warning
[20]	Alarm (trip)
[21]	Alarm (trip lock)
[22]	Comparator 0
[23]	Comparator 1
[24]	Comparator 2
[25]	Comparator 3
[26]	Logic rule 0
[27]	Logic rule 1
[28]	Logic rule 2
[29]	Logic rule 3
[33]	Digital input DI18
[34]	Digital input DI19
[35]	Digital input DI27
[36]	Digital input DI29
[37]	Digital input DI32
[38]	Digital input DI33
[50]	Comparator 4
[51]	Comparator 5
[60]	Logic rule 4
[61]	Logic rule 5

### 15-13 Logging Mode

Option:	Function:
[0] *    Log always	Select <i>Log always</i> [0] for continuous logging.
[1]      Log once on trigger	Select <i>Log once on trigger</i> [1] to conditionally start and stop logging using par. 15-12 <i>Trigger Event</i> and par. 15-14 <i>Samples Before Trigger</i> .

### 15-14 Samples Before Trigger

Range:	Function:
50*      [0 - 100 ]	Enter the percentage of all samples prior to a trigger event which are to be retained in the log. See also par. 15-12 <i>Trigger Event</i> and par. 15-13 <i>Logging Mode</i> .

## 2

**2.14.4 15-2\* Historic Log**

View up to 50 logged data items via the array parameters in this parameter group. For all parameters in the group, [0] is the most recent data and [49] the oldest data. Data is logged every time an *event* occurs (not to be confused with SLC events). *Events* in this context are defined as a change in one of the following areas:

1. Digital input
2. Digital outputs (not monitored in this SW release)
3. Warning word
4. Alarm word
5. Status word
6. Control word
7. Extended status word

*Events* are logged with value, and time stamp in msec. The time interval between two events depends on how often *events* occur (maximum once every scan time). Data logging is continuous but if an alarm occurs, the log is saved and the values can be viewed on the display. This feature is useful, for example when carrying out service following a trip. View the historic log contained in this parameter via the serial communication port or via the display.

**15-20 Historic Log: Event**

Array [50]

**Range:**

0\* [0 - 255 ]

**Function:**

View the event type of the logged events.

**15-21 Historic Log: Value**

Array [50]

**Range:**

0\* [0 - 2147483647 ]

**Function:**

View the value of the logged event. Interpret the event values according to this table:

Digital input	Decimal value. See par. 16-60 <i>Digital Input</i> for description after converting to binary value.
Digital output (not monitored in this SW release)	Decimal value. See par. 16-66 <i>Digital Output [bin]</i> for description after converting to binary value.
Warning word	Decimal value. See par. 16-92 <i>Warning Word</i> for description.
Alarm word	Decimal value. See par. 16-90 <i>Alarm Word</i> for description.
Status word	Decimal value. See par. 16-03 <i>Status Word</i> for description after converting to binary value.
Control word	Decimal value. See par. 16-00 <i>Control Word</i> for description.
Extended status word	Decimal value. See par. 16-94 <i>Ext. Status Word</i> for description.

**15-22 Historic Log: Time**

Array [50]

**Range:**

0 ms\* [0 - 2147483647 ms]

**Function:**

View the time at which the logged event occurred. Time is measured in ms since frequency converter start. The max. value corresponds to approx. 24 days which means that the count will restart at zero after this time period.

### 2.14.5 15-3\* Alarm Log

Parameters in this group are array parameters, where up to 10 fault logs can be viewed. [0] is the most recent logged data, and [9] the oldest. Error codes, values, and time stamp can be viewed for all logged data.

#### 15-30 Alarm Log: Error Code

Array [10]

**Range:**

0\* [0 - 255 ]

**Function:**

View the error code and look up its meaning in the *Troubleshooting* chapter.

#### 15-31 Alarm Log: Value

Array [10]

**Range:**

0\* [-32767 - 32767 ]

**Function:**

View an extra description of the error. This parameter is mostly used in combination with alarm 38 'internal fault'.

#### 15-32 Alarm Log: Time

Array [10]

**Range:**

0 s\* [0 - 2147483647 s]

**Function:**

View the time when the logged event occurred. Time is measured in seconds from frequency converter start-up.

### 2.14.6 15-4\* Drive Identification

Parameters containing read only information about the hardware and software configuration of the frequency converter.

#### 15-40 FC Type

**Option:**

**Function:**

View the FC type. The read-out is identical to the VLT Automation VT Drive Series power field of the type code definition, characters 1-6.

#### 15-41 Power Section

**Option:**

**Function:**

View the FC type. The read-out is identical to the VLT Automation VT Drive Series power field of the type code definition, characters 7-10.

#### 15-42 Voltage

**Option:**

**Function:**

View the FC type. The read-out is identical to the VLT Automation VT Drive Series power field of the type code definition, characters 11-12.

#### 15-43 Software Version

**Range:**

0\* [0 - 0 ]

**Function:**

View the combined SW version (or 'package version') consisting of power SW and control SW.

#### 15-44 Ordered Typecode String

**Range:**

0\* [0 - 0 ]

**Function:**

View the type code string used for re-ordering the frequency converter in its original configuration.

## 2

**15-45 Actual Typecode String**

Range:	Function:
0* [0 - 0 ]	View the actual type code string.

**15-46 Frequency Converter Ordering No**

Range:	Function:
0* [0 - 0 ]	View the 8-digit ordering number used for re-ordering the frequency converter in its original configuration.

**15-47 Power Card Ordering No**

Range:	Function:
0* [0 - 0 ]	View the power card ordering number.

**15-48 LCP Id No**

Range:	Function:
0* [0 - 0 ]	View the LCP ID number.

**15-49 SW ID Control Card**

Range:	Function:
0* [0 - 0 ]	View the control card software version number.

**15-50 SW ID Power Card**

Range:	Function:
0* [0 - 0 ]	View the power card software version number.

**15-51 Frequency Converter Serial Number**

Range:	Function:
0* [0 - 0 ]	View the frequency converter serial number.

**15-53 Power Card Serial Number**

Range:	Function:
0* [0 - 0 ]	View the power card serial number.

**2.14.7 15-6\* Option Ident.**

This read-only parameter group contains information about the hardware and software configuration of the options installed in slots A, B C0 and C1.

**15-60 Option Mounted**

Range:	Function:
0* [0 - 0 ]	View the installed option type.

**15-61 Option SW Version**

Range:	Function:
0* [0 - 0 ]	View the installed option software version.

**15-62 Option Ordering No**

Range:	Function:
0* [0 - 0 ]	Shows the ordering number for the installed options.

**15-63 Option Serial No**

Range:	Function:
0* [0 - 0 ]	View the installed option serial number.

**2.14.8 15-9\* Parameter Info**

Parameter lists

**15-92 Defined Parameters**

Array [1000]

Range:	Function:
0* [0 - 9999 ]	View a list of all defined parameters in the frequency converter. The list ends with 0.

**15-93 Modified Parameters**

Array [1000]

Range:	Function:
0* [0 - 9999 ]	View a list of the parameters that have been changed from their default setting. The list ends with 0. Changes may not be visible until up to 30 seconds after implementation.

**15-99 Parameter Metadata**

Array [23]

Range:	Function:
0* [0 - 9999 ]	This parameter contains data used by the MCT10 software tool.

## 2

## 2.14 Main Menu - Data Readouts - Group 16

### 2.15.1 16-\*\* Data Readouts

Parameter group for data read-outs, e.g. actual references, voltages, control, alarm, warning and status words.

### 2.15.2 16-0\* General Status

Parameters for reading the general status, e.g. the calculated reference, the active control word, status.

#### 16-00 Control Word

**Range:**

0\* [0 - 65535]

**Function:**

View the Control word sent from the frequency converter via the serial communication port in hex code.

#### 16-01 Reference [Unit]

**Range:**

0.000 Ref- [-999999.000 - 999999.000 Refer-  
erenceFeed-enceFeedbackUnit]  
backUnit\*

**Function:**

View the present reference value applied on impulse or analog basis in the unit resulting from the configuration selected in par. 1-00 *Configuration Mode* (Hz, Nm or RPM).

#### 16-02 Reference [%]

**Range:**

0.0 %\* [-200.0 - 200.0 %]

**Function:**

View the total reference. The total reference is the sum of digital, analog, preset, bus, and freeze references, plus catch-up and slow-down.

#### 16-03 Status Word

**Range:**

0\* [0 - 65535]

**Function:**

View the Status word sent from the frequency converter via the serial communication port in hex code.

#### 16-05 Main Actual Value [%]

**Range:**

0.00%\* [-100.00% - 100.00%]

**Function:**

View the two-byte word sent with the Status word to the bus Master reporting the Main Actual Value. Please refer to the Profibus Operating Instructions MG.33.CX.YY for a detailed description.

#### 16-09 Custom Readout

**Range:**

0.00 Cus- [-999999.99 - 999999.99 Custom-  
tomReadou-ReadoutUnit]  
tUnit\*

**Function:**

View the user-defined readouts as defined in par. 0-30 *Custom Readout Unit*, par. 0-31 *Custom Readout Min Value* and par. 0-32 *Custom Readout Max Value*.

### 2.15.3 16-1\* Motor Status

Parameters for reading the motor status values.

**16-10 Power [kW]**

Range:	Function:
0.00 kW* [0.00 - 10000.00 kW]	View the motor power in kW. The value shown is calculated on the basis of the actual motor voltage and motor current. The value is filtered, and therefore approx. 30 ms may pass from when an input value changes to when the data read-out values change.

**16-11 Power [hp]**

Range:	Function:
0.00 hp* [0.00 - 10000.00 hp]	View the motor power in HP. The value shown is calculated on the basis of the actual motor voltage and motor current. The value is filtered, and therefore approximately 30 ms may pass from when an input value changes to when the data read-out values change.

**16-12 Motor Voltage**

Range:	Function:
0.0 V* [0.0 - 6000.0 V]	View the motor voltage, a calculated value used for controlling the motor.

**16-13 Frequency**

Range:	Function:
0.0 Hz* [0.0 - 6500.0 Hz]	View the motor frequency, without resonance dampening.

**16-14 Motor Current**

Range:	Function:
0.00 A* [0.00 - 10000.00 A]	View the motor current measured as a mean value, IRMS. The value is filtered, and thus approximately 30 ms may pass from when an input value changes to when the data read-out values change.

**16-15 Frequency [%]**

Range:	Function:
0.00 %* [-100.00 - 100.00 %]	View a two-byte word reporting the actual motor frequency (without resonance dampening) as a percentage (scale 0000-4000 Hex) of par. 4-19 <i>Max Output Frequency</i> . Set par. 9-16 <i>PCD Read Configuration</i> index 1 to send it with the Status Word instead of the MAV.

**16-16 Torque [Nm]**

Range:	Function:
0.0 Nm* [-30000.0 - 30000.0 Nm]	View the torque value with sign, applied to the motor shaft. Linearity is not exact between 110% motor current and torque in relation to the rated torque. Some motors supply more than 160% torque. Consequently, the min. value and the max. value will depend on the max. motor current as well as the motor used. The value is filtered, and thus approx. 1.3 seconds may pass from when an input changes value to when the data read-out values change.

**16-17 Speed [RPM]**

Range:	Function:
0 RPM* [-30000 - 30000 RPM]	View the actual motor RPM.

**16-18 Motor Thermal**

Range:	Function:
0 %* [0 - 100 %]	View the calculated thermal load on the motor. The cut-out limit is 100%. The basis for calculation is the ETRElectronic Thermal Overload function selected in par. 1-90 <i>Motor Thermal Protection</i> .

**16-22 Torque [%]****Range:**

0 %\* [-200 - 200 %]

**Function:**

This is a read out parameter only.

Shows the actual torque yielded in percentage of the rated torque, based on the setting of the motor size and rated speed in par. 1-20 *Motor Power [kW]* or par. 1-21 *Motor Power [HP]* and par. 1-25 *Motor Nominal Speed*.

This is the value monitored by the *Broken Belt Function* set in par. 22-6\*.

**2.15.4 16-3\* Drive Status**

Parameters for reporting the status of the frequency converter.

**16-30 DC Link Voltage****Range:**

0 V\* [0 - 10000 V]

**Function:**

View a measured value. The value is filtered with an 30 ms time constant.

**16-32 Brake Energy /s****Range:**

0.000 kW\* [0.000 - 10000.000 kW]

**Function:**

View the brake power transmitted to an external brake resistor, stated as an instantaneous value.

**16-33 Brake Energy /2 min****Range:**

0.000 kW\* [0.000 - 10000.000 kW]

**Function:**

View the brake power transmitted to an external brake resistor. The mean power is calculated on an average basis for the most recent 120 seconds.

**16-34 Heatsink Temp.****Range:**

0 C\* [0 - 255 C]

**Function:**

View the frequency converter heatsink temperature. The cut-out limit is  $90 \pm 5$  °C, and the motor cuts back in at  $60 \pm 5$  °C.

**16-35 Inverter Thermal****Range:**

0 %\* [0 - 100 %]

**Function:**

View the percentage load on the inverter.

**16-36 Inv. Nom. Current****Range:**

Application dependent\* [0.01 - 10000.00 A]

**Function:**

View the inverter nominal current, which should match the nameplate data on the connected motor. The data are used for calculation of torque, motor protection, etc.

**16-37 Inv. Max. Current****Range:**

Application dependent\* [0.01 - 10000.00 A]

**Function:**

View the inverter maximum current, which should match the nameplate data on the connected motor. The data are used for calculation of torque, motor protection, etc.

**16-38 SL Controller State****Range:**

0\* [0 - 100 ]

**Function:**

View the state of the event under execution by the SL controller.

**16-39 Control Card Temp.**

Range:	Function:
0 C* [0 - 100 C]	View the temperature on the control card, stated in °C.

**16-40 Logging Buffer Full**

Option:	Function:
[0] * No	View whether the logging buffer is full (see par. 15-1*). The logging buffer will never be full when par. 15-13 <i>Logging Mode</i> is set to <i>Log always</i> [0].
[1] Yes	

**2.15.5 16-5\* Ref. & Feedb.**

Parameters for reporting the reference and feedback input.

**16-50 External Reference**

Range:	Function:
0.0* [-200.0 - 200.0 ]	View the total reference, the sum of digital, analog, preset, bus and freeze references, plus catch-up and slow-down.

**16-52 Feedback [Unit]**

Range:	Function:
0.000 Proc-essCtrlUnit* [-999999.999 - 999999.999 Proc-essCtrlUnit]	View value of resulting feedback value after processing of Feedback 1-3 (see par. 16-54 <i>Feedback 1 [Unit]</i> , par. 16-55 <i>Feedback 2 [Unit]</i> and par. 16-56) in the feedback manager.  See par. 20-0* <i>Feedback</i> .  The value is limited by settings in par. 20-13 and par. 20-14. Units as set in par. 20-12 <i>Reference/Feedback Unit</i> .

**16-53 Digi Pot Reference**

Range:	Function:
0.00* [-200.00 - 200.00 ]	View the contribution of the Digital Potentiometer to the actual reference.

**16-54 Feedback 1 [Unit]**

Range:	Function:
0.000 Proc-essCtrlUnit* [-999999.999 - 999999.999 Proc-essCtrlUnit]	View value of Feedback 1, see par. 20-0* <i>Feedback</i> .  The value is limited by settings in par. 20-13 <i>Minimum Reference/Feedb.</i> and par. 20-14 <i>Maximum Reference/Feedb.</i> . Units as set in par. 20-12 <i>Reference/Feedback Unit</i> .

**16-55 Feedback 2 [Unit]**

Range:	Function:
0.000 Proc-essCtrlUnit* [-999999.999 - 999999.999 Proc-essCtrlUnit]	View value of Feedback 2, see par. 20-0* <i>Feedback</i> .  The value is limited by settings in par. 20-13 and par. 20-14. Units as set in par. 20-12 <i>Reference/Feedback Unit</i> .

**2****16-56 Feedback 3 [Unit]****Range:**0.000 Proc- [-999999.999 - 999999.999 Proc-  
essCtrlU- essCtrlUnit]  
nit\***Function:**View value of Feedback 3, see par. 20-0\* *Feedback*.The value is limited by settings in par. 20-13 *Minimum Reference/Feedb.* and par. 20-14 *Maximum Reference/Feedb.*. Units as set in par. 20-12 *Reference/Feedback Unit*.**16-59 Adjusted Setpoint****Option:****Function:**

View value of the adjusted set point according to par.20-29.

### 2.15.6 16-6\* Inputs and Outputs

Parameters for reporting the digital and analog IO ports.

2

#### 16-60 Digital Input

**Range:**

0\* [0 - 63]

**Function:**

View the signal states from the active digital inputs. Input 18 corresponds for example to bit 5. '0' = NO signal, '1' = connected signal.

Bit 0	Digital input term. 33
Bit 1	Digital input term. 32
Bit 2	Digital input term. 29
Bit 3	Digital input term. 27
Bit 4	Digital input term. 19
Bit 5	Digital input term. 18
Bit 6	Digital input term. 37
Bit 7	Digital input GP I/O term. X30/2
Bit 8	Digital input GP I/O term. X30/3
Bit 9	Digital input GP I/O term. X30/4
Bit 10-63	Reserved for future terminals

#### 16-61 Terminal 53 Switch Setting

**Option:**

[0] \* Current

[1] Voltage

[2] Pt 1000 [°C]

[3] Pt 1000 [°F]

[4] Ni 1000 [°C]

[5] Ni 1000 [°F]

**Function:**

View the setting of input terminal 53. Current = 0; Voltage = 1.

#### 16-62 Analog Input 53

**Range:**

0.000\* [-20.000 - 20.000 ]

**Function:**

View the actual value at input 53.

#### 16-63 Terminal 54 Switch Setting

**Option:**

[0] \* Current

[1] Voltage

[2] Pt 1000 [°C]

[3] Pt 1000 [°F]

[4] Ni 1000 [°C]

[5] Ni 1000 [°F]

**Function:**

View the setting of input terminal 54. Current = 0; Voltage = 1.

2

**16-64 Analog Input 54**

**Range:** 0.000\* [-20.000 - 20.000 ]  
**Function:** View the actual value at input 54.

**16-65 Analog Output 42 [mA]**

**Range:** 0.000\* [0.000 - 30.000 ]  
**Function:** View the actual value at output 42 in mA. The value shown reflects the selection in par. 6-50 *Terminal 42 Output*.

**16-66 Digital Output [bin]**

**Range:** 0\* [0 - 15 ]  
**Function:** View the binary value of all digital outputs.

**16-67 Freq. Input #29 [Hz]**

**Range:** 0\* [0 - 0 ]  
**Function:** View the actual frequency rate on terminal 29.

**16-68 Freq. Input #33 [Hz]**

**Range:** 0\* [0 - 0 ]  
**Function:** View the actual frequency rate on terminal 33.

**16-69 Pulse Output #27 [Hz]**

**Range:** 0\* [0 - 0 ]  
**Function:** View the actual value on terminal 27 in digital output mode.

**16-70 Pulse Output #29 [Hz]**

**Range:** 0\* [0 - 0 ]  
**Function:** View the actual value of pulses on terminal 29 in digital output mode.

**16-71 Relay Output [bin]**

**Range:** 0\* [0 - 65535 ]  
**Function:** View the settings of all relays.

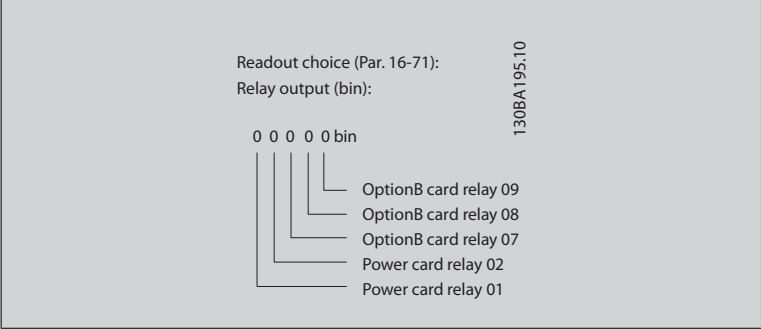

**16-72 Counter A**

Range:	Function:
0* [-2147483648 - 2147483647 ]	View the present value of Counter A. Counters are useful as comparator operands, see par. 13-10 <i>Comparator Operand</i> . The value can be reset or changed either via digital inputs (parameter group 5-1*) or by using an SLC action (par. 13-52 <i>SL Controller Action</i> ).

**16-73 Counter B**

Range:	Function:
0* [-2147483648 - 2147483647 ]	View the present value of Counter B. Counters are useful as comparator operands (par. 13-10 <i>Comparator Operand</i> ). The value can be reset or changed either via digital inputs (parameter group 5-1*) or by using an SLC action (par. 13-52 <i>SL Controller Action</i> ).

**16-74 Precise Stop Counter**

Option:	Function:
[0] * -2147483648 - 2147483648	Returns the actual counter value of precise counter.

**16-75 Analog In X30/11**

Range:	Function:
0.000* [-20.000 - 20.000 ]	View the actual value at input X30/11 of MCB 101.

**16-76 Analog In X30/12**

Range:	Function:
0.000* [-20.000 - 20.000 ]	View the actual value at input X30/12 of MCB 101.

**16-77 Analog Out X30/8 [mA]**

Range:	Function:
0.000* [0.000 - 30.000 ]	View the actual value at input X30/8 in mA.

**2.15.7 16-8\* Fieldbus & FC Port**

Parameters for reporting the BUS references and control words.

**16-80 Fieldbus CTW 1**

Range:	Function:
0* [0 - 65535 ]	View the two-byte Control word (CTW) received from the Bus-Master. Interpretation of the Control word depends on the fieldbus option installed and the Control word profile selected in par. 8-10 <i>Control Profile</i> . For more information please refer to the relevant fieldbus manual.

**16-82 Fieldbus REF 1**

Range:	Function:
0* [-200 - 200 ]	View the two-byte word sent with the control word form the Bus-Master to set the reference value. For more information please refer to the relevant fieldbus manual.

## 2

**16-84 Comm. Option STW****Range:**

0\* [0 - 65535 ]

**Function:**

View the extended fieldbus comm. option status word.  
For more information please refer to the relevant fieldbus manual.

**16-85 FC Port CTW 1****Range:**

0\* [0 - 65535 ]

**Function:**

View the two-byte Control word (CTW) received from the Bus-Master. Interpretation of the control word depends on the fieldbus option installed and the Control word profile selected in par. 8-10 *Control Profile*.

**16-86 FC Port REF 1****Range:**

0\* [-200 - 200 ]

**Function:**

View the two-byte Status word (STW) sent to the Bus-Master. Interpretation of the Status word depends on the fieldbus option installed and the Control word profile selected in par. 8-10 *Control Profile*.

### 2.15.8 16-9\* Diagnosis Read-Outs

Parameters displaying alarm, warning and extended status words.

16-90 Alarm Word		
Range:		Function:
0*	[0 - 4294967295 ]	View the alarm word sent via the serial communication port in hex code.
16-91 Alarm Word 2		
Range:		Function:
0*	[0 - 4294967295 ]	View the alarm word 2 sent via the serial communication port in hex code.
16-92 Warning Word		
Range:		Function:
0*	[0 - 4294967295 ]	View the warning word sent via the serial communication port in hex code.
16-93 Warning Word 2		
Range:		Function:
0*	[0 - 4294967295 ]	View the warning word 2 sent via the serial communication port in hex code.
16-94 Ext. Status Word		
Range:		Function:
0*	[0 - 4294967295 ]	Returns the extended status word sent via the serial communication port in hex code.
16-95 Ext. Status Word 2		
Range:		Function:
0*	[0 - 4294967295 ]	Returns the extended warning word 2 sent via the serial communication port in hex code.
16-96 Maintenance Word		
Range:		Function:
0*	[0 - 4294967295 ]	

2

## 2

## 2.15 Main Menu - Data Readouts 2 - Group 18

### 2.16.1 18-0\* Maintenance LogLG-0# Maintenance Log

This group contains the last 10 Preventive Maintenance logs. Maintenance Log 0 is the latest log and Maintenance Log 9 the oldest.

By selecting one of the logs and pressing OK, the Maintenance Item, Action and time of the occurrence can be found in par. 18-00 *Maintenance Log: Item* – par. 18-03 *Maintenance Log: Date and Time*.

The Alarm log button on the LCP allows access to both Alarm log and Maintenance log.

#### 18-00 Maintenance Log: Item

Array [10]

**Range:**

0\* [0 - 255 ]

**Function:**

Locate the meaning of the Maintenance Item in the description of par. 23-10 *Maintenance Item* .

#### 18-01 Maintenance Log: Action

Array [10]

**Range:**

0\* [0 - 255 ]

**Function:**

Locate the meaning of the Maintenance Item in the description of par. 23-11 *Maintenance Action*

#### 18-02 Maintenance Log: Time

Array [10]

**Range:**

0 s\* [0 - 2147483647 s]

**Function:**

Shows when the logged event occurred. Time is measured in seconds since last power-up.

#### 18-03 Maintenance Log: Date and Time

Array [10]

**Range:**

Application [Application dependant]  
dependent\*

**Function:**

**NB!**

When mounting an Analog I/O MCB 109 option card, a battery back-up of date and time is included.

#### 18-30 Analog Input X42/1

**Range:**

0.000\* [-20.000 - 20.000 ]

**Function:**

Read out of the value of the signal applied to terminal X42/1 on the Analog I/O Card.  
The units of the value shown in the LCP will correspond to the mode selected in par. 26-00 *Terminal X42/1 Mode*.

#### 18-31 Analog Input X42/3

**Range:**

0.000\* [-20.000 - 20.000 ]

**Function:**

Read out of the value of the signal applied to terminal X42/3 on the Analog I/O Card.  
The units of the value shown in the LCP will correspond to the mode selected in par. 26-01 *Terminal X42/3 Mode*.

**18-32 Analog Input X42/5**

**Range:**

0.000\* [-20.000 - 20.000 ]

**Function:**

Read out of the value of the signal applied to terminal X42/5 on the Analog I/O Card.  
The units of the value shown in the LCP will correspond to the mode selected in par. 26-02 *Terminal X42/5 Mode*.

**18-33 Analog Out X42/7 [V]**

**Range:**

0.000\* [0.000 - 30.000 ]

**Function:**

Read out of the value of the signal applied to terminal X42/7 on the Analog I/O Card.  
The value shown reflects the selection in par. 26-40 *Terminal X42/7 Output*.

**18-34 Analog Out X42/9 [V]**

**Range:**

0.000\* [0.000 - 30.000 ]

**Function:**

Read out of the value of the signal applied to terminal X42/9 on the Analog I/O Card.  
The value shown reflects the selection in par. 26-50 *Terminal X42/9 Output*.

**18-35 Analog Out X42/11 [V]**

**Range:**

0.000\* [0.000 - 30.000 ]

**Function:**

Read out of the value of the signal applied to terminal X42/11 on the Analog I/O Card.  
The value shown reflects the selection in par. 26-60 *Terminal X42/11 Output*.

2

## 2.16 Main Menu - FC Closed Loop - Group 20

### 2.17.1 Drive Closed Loop, 20-\*\*

2

This parameter group is used for configuring the closed loop PID Controller, that controls the output frequency of the frequency converter.

### 2.17.2 Feedback, 20-0\*

This parameter group is used to configure the feedback signal for the frequency converter's closed loop PID Controller. Whether the frequency converter is in Closed Loop Mode or Open Loop Mode, the feedback signals can be shown on the frequency converter's display. It can also be used to control a frequency converter analog output, and be transmitted over various serial communication protocols.

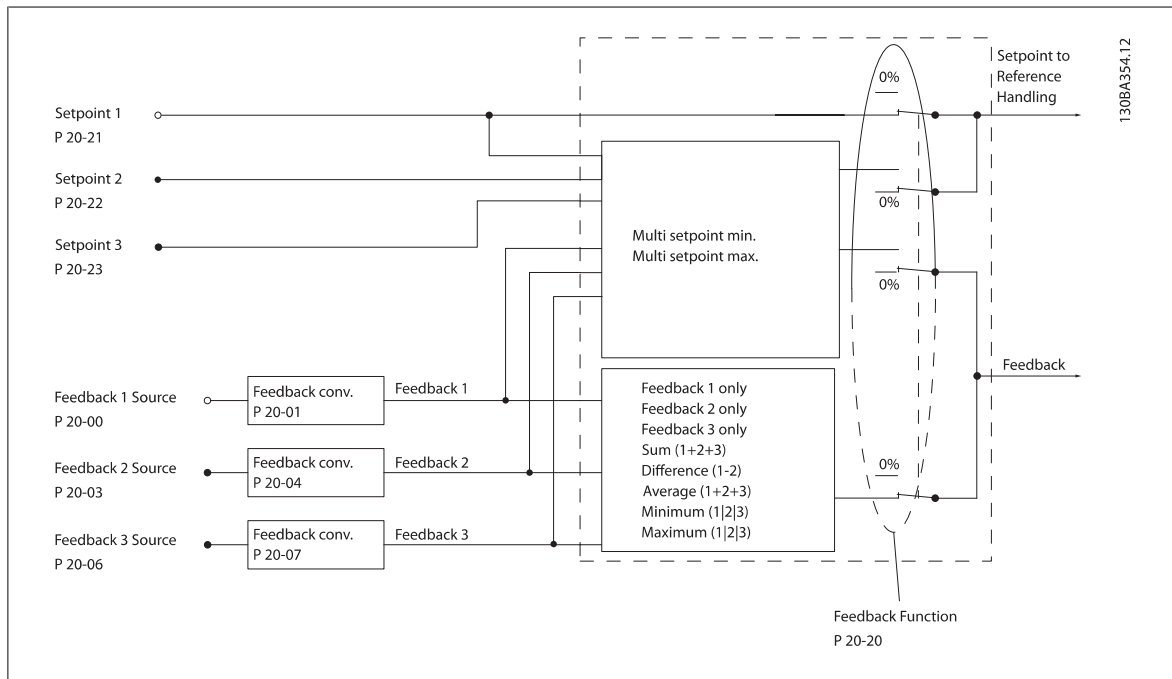

#### 20-00 Feedback 1 Source

**Option:**

**Function:**

Up to three different feedback signals can be used to provide the feedback signal for the frequency converter's PID Controller.

This parameter defines which input will be used as the source of the first feedback signal.

Analog input X30/11 and Analog input X30/12 refer to inputs on the optional General Purpose I/O board.

[0] No function

[1] Analog input 53

[2] \* Analog input 54

[3] Pulse input 29

[4] Pulse input 33

[7] Analog input X30/11

- [8] Analog input X30/12
- [9] Analog Input X42/1
- [10] Analog Input X42/3
- [11] Analog Input X42/5
- [15] Analog Input X48/2
- [100] Bus feedback 1
- [101] Bus feedback 2
- [102] Bus feedback 3
- [200] Ext. Closed Loop 1
- [201] Ext. Closed Loop 2
- [202] Ext. Closed Loop 3

**NB!**  
If a feedback is not used, its source must be set to *No Function* [0]. par. 20-20 *Feedback Function* determines how the three possible feedbacks will be used by the PID Controller.

**20-01 Feedback 1 Conversion**

<b>Option:</b>	<b>Function:</b>
[0] * Linear	
[1] Square root	This parameter allows a conversion function to be applied to Feedback 1. <i>Linear</i> [0] has no effect on the feedback. <i>Square root</i> [1] is commonly used when a pressure sensor is used to provide flow feedback (( $flow \propto \sqrt{pressure}$ )).

**20-03 Feedback 2 Source**

<b>Option:</b>	<b>Function:</b>
	See par. 20-00 <i>Feedback 1 Source</i> for details.
[0] * No function	
[1] Analog input 53	
[2] Analog input 54	
[3] Pulse input 29	
[4] Pulse input 33	
[7] Analog input X30/11	
[8] Analog input X30/12	
[9] Analog Input X42/1	
[10] Analog Input X42/3	
[11] Analog Input X42/5	
[15] Analog Input X48/2	
[100] Bus feedback 1	
[101] Bus feedback 2	
[102] Bus feedback 3	
[200] Ext. Closed Loop 1	
[201] Ext. Closed Loop 2	
[202] Ext. Closed Loop 3	

**20-04 Feedback 2 Conversion****Option:****Function:**See par. 20-01 *Feedback 1 Conversion* for details.

[0] *	Linear
[1]	Square root

**20-06 Feedback 3 Source****Option:****Function:**See par. 20-00 *Feedback 1 Source* for details.

[0] *	No function
[1]	Analog input 53
[2]	Analog input 54
[3]	Pulse input 29
[4]	Pulse input 33
[7]	Analog input X30/11
[8]	Analog input X30/12
[9]	Analog Input X42/1
[10]	Analog Input X42/3
[11]	Analog Input X42/5
[15]	Analog Input X48/2
[100]	Bus feedback 1
[101]	Bus feedback 2
[102]	Bus feedback 3
[200]	Ext. Closed Loop 1
[201]	Ext. Closed Loop 2
[202]	Ext. Closed Loop 3

**20-07 Feedback 3 Conversion****Option:****Function:**See par. 20-01 *Feedback 1 Conversion* for details.

[0] *	Linear
[1]	Square root

**20-12 Reference/Feedback Unit****Option:****Function:**

[0]	None
[1] *	%
[5]	PPM
[10]	1/min
[11]	RPM
[12]	Pulse/s
[20]	l/s
[21]	l/min
[22]	l/h
[23]	m <sup>3</sup> /s

**2**

[24]	m <sup>3</sup> /min
[25]	m <sup>3</sup> /h
[30]	kg/s
[31]	kg/min
[32]	kg/h
[33]	t/min
[34]	t/h
[40]	m/s
[41]	m/min
[45]	m
[60]	°C
[70]	mbar
[71]	bar
[72]	Pa
[73]	kPa
[74]	m WG
[75]	mm Hg
[80]	kW
[120]	GPM
[121]	gal/s
[122]	gal/min
[123]	gal/h
[124]	CFM
[125]	ft <sup>3</sup> /s
[126]	ft <sup>3</sup> /min
[127]	ft <sup>3</sup> /h
[130]	lb/s
[131]	lb/min
[132]	lb/h
[140]	ft/s
[141]	ft/min
[145]	ft
[160]	°F
[170]	psi
[171]	lb/in <sup>2</sup>
[172]	in WG
[173]	ft WG
[174]	in Hg
[180]	HP

This parameter determines the unit that is used for the setpoint reference and feedback that the PID Controller will use for controlling the output frequency of the frequency converter.

### 2.17.3 20-2\* Feedback & Setpoint

This parameter group is used to determine how the frequency converter's PID Controller will use the three possible feedback signals to control the output frequency of the frequency converter. This group is also used to store the three internal setpoint references.

# 2

#### 20-20 Feedback Function

Option:	Function:
[0]	Sum
[1]	Difference
[2]	Average
[3] *	Minimum
[4]	Maximum
[5]	Multi setpoint min
[6]	Multi setpoint max

This parameter determines how the three possible feedbacks will be used to control the output frequency of the frequency converter.

**NB!**  
Any unused feedback must be set to "No function" in its Feedback Source parameter: 20-00, 20-03 or 20-06.

The feedback resulting from the function selected in par. 20-20 will be used by the PID Controller to control the output frequency of the frequency converter. This feedback can also be shown on the frequency converter's display, be used to control a frequency converter's analog output, and be transmitted over various serial communication protocols.

The frequency converter can be configured to handle multi zone applications. Two different multi zone applications are supported:

- Multi zone, single setpoint
- Multi zone, multi setpoint

The difference between the two is illustrated by the following examples:

#### Example 1 – Multi zone, single setpoint

In an office building, a VAV (variable air volume) water system must ensure a minimum pressure at selected VAV boxes. Due to the varying pressure losses in each duct, the pressure at each VAV box cannot be assumed to be the same. The minimum pressure required is the same for all VAV boxes. This control method can be set up by setting *Feedback Function*, par. 20-20 to option [3], Minimum, and entering the desired pressure in par. 20-21. The PID Controller will increase the speed of the fan if any one feedback is below the setpoint and decrease the speed of the fan if all feedbacks are above the setpoint.

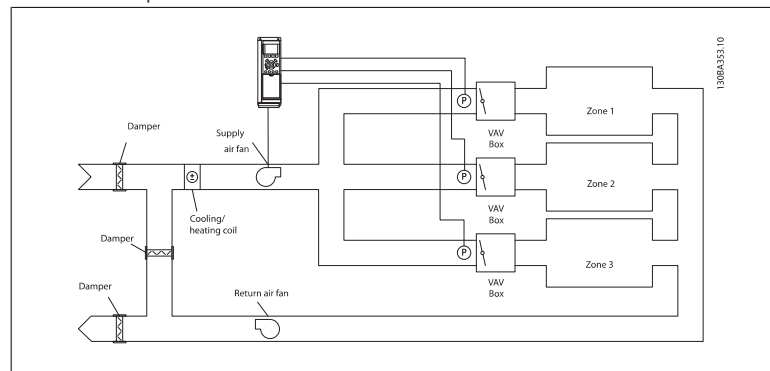

#### Example 2 – Multi zone, multi setpoint

The previous example can be used to illustrate the use of multi zone, multi setpoint control. If the zones require different pressures for each VAV box, each setpoint may be specified in par. 20-21, 20-22 and 20-23. By selecting *Multi setpoint minimum*, [5], in par. 20-20, Feedback Function, the PID Controller will increase the speed of the fan if any one of the feedbacks is below its setpoint and decrease the speed of the fan if all feedbacks are above their individual setpoints. *Sum* [0] sets up the PID Controller to use the sum of Feedback 1, Feedback 2 and Feedback 3 as the feedback.



**NB!**  
Any unused feedbacks must be set to *No Function* in par. 20-00, 20-03, or 20-06.

The sum of Setpoint 1 and any other references that are enabled (see par. group 3-1\*) will be used as the PID Controller's setpoint reference.

*Difference* [1] sets up the PID Controller to use the difference between Feedback 1 and Feedback 2 as the feedback. Feedback 3 will not be used with this selection. Only setpoint 1 will be used. The sum of Setpoint 1 and any other references that are enabled (see par. group 3-1\*) will be used as the PID Controller's setpoint reference.

*Average* [2] sets up the PID Controller to use the average of Feedback 1, Feedback 2 and Feedback 3 as the feedback.



**NB!**  
Any unused feedbacks must be set to *No Function* in par. 20-00, 20-03, or 20-06.  
The sum of Setpoint 1 and any other references that are enabled (see par. group 3-1\*) will be used as the PID Controller's setpoint reference.

*Minimum* [3] sets up the PID Controller to compare Feedback 1, Feedback 2 and Feedback 3 and use the lowest value as the feedback.



**NB!**  
Any unused feedbacks must be set to *No Function* in par. 20-00, 20-03, or 20-06.  
Only setpoint 1 will be used. The sum of Setpoint 1 and any other references that are enabled (see par. group 3-1\*) will be used as the PID Controller's setpoint reference.

*Maximum* [4] sets up the PID Controller to compare Feedback 1, Feedback 2 and Feedback 3 and use the highest value as the feedback.



**NB!**  
Any unused feedbacks must be set to *No Function* in par. 20-00, 20-03, or 20-06.

Only Setpoint 1 will be used. The sum of Setpoint 1 and any other references that are enabled (see par. group 3-1\*) will be used as the PID Controller's setpoint reference.

*Multi-setpoint minimum* [5] sets up the PID Controller to calculate the difference between Feedback 1 and Setpoint 1, Feedback 2 and Setpoint 2, and Feedback 3 and Setpoint 3. It will use the feedback/setpoint pair in which the feedback is the farthest below its corresponding setpoint reference. If all feedback signals are above their corresponding setpoints, the PID Controller will use the feedback/setpoint pair in which the difference between the feedback and setpoint is the least.



**NB!**  
If only two feedback signals are used, the feedback that is not to be used must be set to *No Function* in par. 20-00, 20-03 or 20-06. Note that each setpoint reference will be the sum of its respective parameter value ( 20-12 and 20-13) and any other references that are enabled (see par. group 3-1\*).

*Multi-setpoint maximum* [6] sets up the PID Controller to calculate the difference between Feedback 1 and Setpoint 1, Feedback 2 and Setpoint 2, and Feedback 3 and Setpoint 3. It will use the feedback/setpoint pair in which the feedback is farthest above its corresponding setpoint reference. If

all feedback signals are below their corresponding setpoints, the PID Controller will use the feedback/setpoint pair in which the difference between the feedback and the setpoint reference is the least.

**NB!**

If only two feedback signals are used, the feedback that is not to be used must be set to *No Function* in par. 20-00, 20-03 or 20-06. Note that each setpoint reference will be the sum of its respective parameter value (20-21, 20-22 and 20-23) and any other references that are enabled (see par. group 3-1\*).

**20-21 Setpoint 1****Range:**

0.000 Proc- [-999999.999 - 999999.999 Proc-  
essCtrlU- essCtrlUnit]  
nit\*

**Function:**

Setpoint 1 is used in Closed Loop Mode to enter a setpoint reference that is used by the frequency converter's PID Controller. See the description of par. 20-20 *Feedback Function*.

**NB!**

Setpoint reference entered here is added to any other references that are enabled (see par. group 3-1\*).

**20-22 Setpoint 2****Range:**

0.000 Proc- [-999999.999 - 999999.999 Proc-  
essCtrlU- essCtrlUnit]  
nit\*

**Function:**

Setpoint 2 is used in Closed Loop Mode to enter a setpoint reference that may be used by the frequency converter's PID Controller. See the description of *Feedback Function*, par. 20-20 *Feedback Function*.

**NB!**

The setpoint reference entered here is added to any other references that are enabled (see par. group 3-1\*).

**20-23 Setpoint 3****Range:**

0.000\* [Ref<sub>MIN</sub> - Ref<sub>MAX</sub> UNIT (from par.  
20-12)]

**Function:**

Setpoint 3 is used in Closed Loop Mode to enter a setpoint reference that may be used by the frequency converter's PID Controller. See the description of par. 20-20 *Feedback Function*.

**NB!**

If the min and max references are altered, a new PI - Autotune may be needed.

**NB!**

The setpoint reference entered here is added to any other references that are enabled (see par. group 3-1\*).

**2.17.4 20-7\* PID autotuning**

The frequency converter PID Closed Loop controller (parameters 20-\*\*, FC Closed Loop) can be auto-tuned, simplifying and saving time during commissioning, whilst ensuring accurate PID control adjustment. To use auto-tuning it is necessary for the frequency converter to be configured for closed loop in par. 1-00 *Configuration Mode*.

A Graphical Local Control Panel (LCP) must be used in order to react on messages during the auto-tuning sequence.

Enabling par. 20-79 *PID Autotuning*, puts the frequency converter into auto-tuning mode. The LCP then directs the user with on-screen instructions.

The fan/pump is started by pressing [Auto On] button on the LCP and applying a start signal. The speed is adjusted manually by pressing the [▲] or [▼] navigation keys on the LCP to a level where the feedback is around the system set-point.



**NB!**  
It is not possible to run the motor at maximum or minimum speed, when manually adjusting the motor speed due to the need of giving the motor a step in the speed during auto-tuning.

PID auto-tuning functions by introducing step changes whilst operating at a steady state and then monitoring the feedback. From the feedback response, the required values for par. 20-93 *PID Proportional Gain* and par. 20-94 *PID Integral Time* are calculated. par. 20-95 *PID Differentiation Time* is set to value 0 (zero). par. 20-81 *PID Normal/ Inverse Control* is determined during tuning process.

These calculated values are presented on the LCP and the user can decide whether to accept or reject them. Once accepted, the values are written to the relevant parameters and auto-tuning mode is disabled in par. 20-79 *PID Autotuning*. Depending on the system being controlled the time required to carry out auto-tuning could be several minutes.

It is advised to set the ramp times in par. 3-41 *Ramp 1 Ramp Up Time*, par. 3-42 *Ramp 1 Ramp Down Time* or par. 3-51 *Ramp 2 Ramp Up Time* and par. 3-52 *Ramp 2 Ramp Down Time* according to the load inertia before carrying out PID autotuning. If PID autotuning is carried out with slow ramp times, the auto-tuned parameters will typically result in very slow control. Excessive feedback sensor noise should be removed using the input filter (parameter groups 6-\*\*, 5-5\* and 26-\*\*, Terminal 53/54 Filter Time Constant/Pulse Filter Time Constant #29/33) before activating PID autotuning. In order to obtain the most accurate controller parameters, it is advised to carry out PID autotuning, when the application is running in typical operation, i.e. with a typical load.

### 20-70 Closed Loop Type

Option:	Function:
	This parameter defines the application response. The default mode should be sufficient for most applications. If the application response speed is known, it can be selected here. This will decrease the time needed for carrying out PID autotuning. The setting has no impact on the value of the tuned parameters and is used only for the autotuning sequence.
[0] *    Auto	
[1]        Fast Pressure	
[2]        Slow Pressure	
[3]        Fast Temperature	
[4]        Slow Temperature	

### 20-79 PID Autotuning

Option:	Function:
	Select the relative response speed for the application.
[0] *    Disabled	
[1]        Enabled	

**20-72 PID Output Change****Range:**

0.10\* [0.01 - 0.50 ]

**Function:**

This parameter sets the magnitude of step change during autotuning. The value is a percentage of full speed. I.e. if maximum output frequency in par. 4-13 *Motor Speed High Limit [RPM]* par. 4-14 *Motor Speed High Limit [Hz]* is set to 50Hz, 0.10 is 10% of 50Hz, which is 5Hz. This parameter should be set to a value resulting in feedback changes of between 10% and 20% for best tuning accuracy.

**20-73 Minimum Feedback Level****Range:**-999999.00 [Application dependant]  
0 Proc-  
essCtrlU-  
nit\***Function:**

The minimum allowable feedback level should be entered here in User units as defined in par. 20-12 *Reference/Feedback Unit*. If the level falls below par. 20-73 *Minimum Feedback Level*, autotuning is aborted and an error message will appear on the LCP.

**20-74 Maximum Feedback Level****Range:**999999.000 [Application dependant]  
ProcessCtrlU-  
nit\***Function:**

The maximum allowable feedback level should be entered here in User units as defined in par. 20-12 *Reference/Feedback Unit*. If the level rises above par. 20-74 *Maximum Feedback Level*, autotuning is aborted and an error message will appear on the LCP.

**20-79 PID Autotuning****Option:**

This parameter starts the PID autotuning sequence. Once the autotuning has successfully completed and the settings have been accepted or rejected by the user, by pressing [OK] or [Cancel] buttons on the LCP at the end of tuning, this parameter is reset to [0] Disabled.

[0] \* Disabled

[1] Enabled

**2.17.5 20-8\* PID Basic Settings**

This parameter group is used to configure the basic operation of the frequency converter's PID Controller, including how it responds to a feedback that is above or below the setpoint, the speed at which it first starts functioning, and when it will indicate that the system has reached the setpoint.

**20-81 PID Normal/Inverse Control****Option:**

[0] \* Normal

[1] Inverse

**Function:**

*Normal* [0] causes the frequency converter's output frequency to decrease when the feedback is greater than the setpoint reference. This is common for pressure-controlled supply fan and pump applications.

*Inverse* [1] causes the frequency converter's output frequency to increase when the feedback is greater than the setpoint reference.

**20-82 PID Start Speed [RPM]****Range:**Application [Application dependant]  
dependent\***Function:**

**20-83 PID Start Speed [Hz]**

Range:	Function:
Application [Application dependant] dependent*	

**20-84 On Reference Bandwidth**

Range:	Function:
5 %* [0 - 200 %]	When the difference between the feedback and the setpoint reference is less than the value of this parameter, the frequency converter's display will show "Run on Reference". This status can be communicated externally by programming the function of a digital output for <i>Run on Reference/No Warning</i> [8]. In addition, for serial communications, the On Reference status bit of the frequency converter's Status Word will be high (1). The <i>On Reference Bandwidth</i> is calculated as a percentage of the setpoint reference.

**2.17.6 20-9\* PID Controller**

This group provides the ability to manually adjust this PID Controller. By adjusting the PID Controller parameters the control performance may be improved. See section on *PID* in the chapter *Introduction to VLT Automation VT Drive* in the **VLT Automation VT Drive Design Guide** for guidelines on adjusting the PID Controller parameters.

**20-91 PID Anti Windup**

Option:	Function:
[0] Off	<i>Off</i> [0] The integrator will continue to change value also after output has reached one of the extremes. This can afterwards cause a delay of change of the output of the controller.
[1] * On	<i>On</i> [1] The integrator will be locked if the output of the built in PID controller has reached one of the extremes (min or max value) and therefore not able to add further change to the value of the process parameter controlled. This allows the controller to respond more quickly when it again can control the system.

**20-93 PID Proportional Gain**

Range:	Function:
2.00* [0.00 - 10.00 ]	

If (Error x Gain) jumps with a value equal to what is set in par. 20-14 *Maximum Reference/Feedb*, the PID controller will try to change the output speed equal to what is set in par. 4-13 *Motor Speed High Limit [RPM]* par. 4-14 *Motor Speed High Limit [Hz]* but in practice of course limited by this setting. The proportional band (error causing output to change from 0-100%) can be calculated by means of the formula:

$$\left( \frac{1}{\text{Proportional Gain}} \right) \times (\text{Max Reference})$$

**NB!**  
Always set the desired for par. 20-14 *Maximum Reference/Feedb*, before setting the values for the PID controller in par. group 20-9\*.

**20-94 PID Integral Time****Range:**

8.00 s\* [0.01 - 10000.00 s]

**Function:**

Over time, the integrator accumulates a contribution to the output from the PID controller as long as there is a deviation between the Reference/Setpoint and feedback signals. The contribution is proportional to the size of the deviation. This ensures that the deviation (error) approaches zero. Quick response on any deviation is obtained when the integral time is set to a low value. Setting it too low, however, may cause the control to become unstable.

The value set, is the time needed for the integrator to add the same contribution as the proportional part for a certain deviation.

If the value is set to 10,000, the controller will act as a pure proportional controller with a P-band based on the value set in par. 20-93 *PID Proportional Gain*. When no deviation is present, the output from the proportional controller will be 0.

**20-95 PID Differentiation Time****Range:**

0.0 s\* [0.00 = Off - 10.00 s]

**Function:**

The differentiator monitors the rate of change of the feedback. If the feedback is changing quickly, it will adjust the output of the PID Controller to reduce the rate of change of the feedback. Quick PID Controller response is obtained when this value is large. However, if too large of a value is used, the frequency converter's output frequency may become unstable.

Differentiation time is useful in situations where extremely fast frequency converter response and precise speed control are required. It can be difficult to adjust this for proper system control. Differentiation time is not commonly used in water/ wastewater applications. Therefore, it is generally best to leave this parameter at 0 or OFF.

**20-96 PID Diff. Gain Limit****Range:**

5.0\* [1.0 - 50.0 ]

**Function:**

The differential function of a PID Controller responds to the rate of change of the feedback. As a result, an abrupt change in the feedback can cause the differential function to make a very large change in the PID Controller's output. This parameter limits the maximum effect that the PID Controller's differential function can produce. A smaller value reduces the maximum effect of the PID Controller's differential function.

This parameter is only active when par. 20-95 *PID Differentiation Time* is not set to OFF (0 s).

## 2.17 Main Menu - Extended Closed Loop - Group 21

### 2.18.1 21-\*\* Ext. Closed Loop

The offers 3 Extended Closed Loop PID controllers in addition to the PID Controller. These can be configured independently to control either external actuators (valves, dampers etc.) or be used together with the internal PID Controller to improve the dynamic responses to setpoint changes or load disturbances.

The Extended Closed Loop PID controllers may be interconnected or connected to the PID Closed Loop controller to form a dual loop configuration.

In order to control a modulating device (e.g. a valve motor), this device must be a positioning servo motor with built-in electronics accepting either a 0-10V (signal from Analog I/O card MCB 109) or a 0/4-20 mA (signal from Control Card and/or General Purpose I/O card MCB 101) control signal.

The output function can be programmed in the following parameters:

- Control Card, terminal 42: par. 6-50 *Terminal 42 Output* (setting [113]...[115] or [149]...[151], Ext. Closed Loop 1/2/3
- General Purpose I/O card MCB 101, terminal X30/8: par. 6-60 *Terminal X30/8 Output*, (setting [113]...[115] or [149]...[151], Ext. Closed Loop 1/2/3
- Analog I/O card MCB 109, terminal X42/7...11: par. 26-40 *Terminal X42/7 Output*, par. 26-50 *Terminal X42/9 Output*, par. 26-60 *Terminal X42/11 Output* (setting [113]...[115], Ext. Closed Loop 1/2/3

General Purpose I/O card and Analog I/O card are optional cards.

### 2.18.2 21-0\* Extended CL autotuning

The extended PID Closed Loop PID controllers (*par. 21-\*\*, Ext. Closed Loop*) can each be auto-tuned, simplifying and saving time during commissioning, whilst ensuring accurate PID control adjustment.

To use PID autotuning it is necessary for the relevant Extended PID controller to have been configured for the application.

A graphical Local Control Panel (LCP) must be used in order to react on messages during the autotuning sequence.

Enabling autotuning par. 21-09 *PID Auto Tuning* puts the relevant PID controller into PID autotuning mode. The LCP then directs the user with on-screen instructions.

PID autotuning functions by introducing step changes and then monitoring the feedback. From the feedback response, the required values for PID Proportional Gain, par. 21-21 *Ext. 1 Proportional Gain* for EXT CL 1, par. 21-41 *Ext. 2 Proportional Gain* for EXT CL 2 and par. 21-61 *Ext. 3 Proportional Gain* for EXT CL 3 and Integral Time, par. 21-22 *Ext. 1 Integral Time* for EXT CL 1, par. 21-42 *Ext. 2 Integral Time* for EXT CL 2 and par. 21-62 *Ext. 3 Integral Time* for EXT CL 3 are calculated. PID Differentiation Time, par. 21-23 *Ext. 1 Differentiation Time* for EXT CL 1, par. 21-43 *Ext. 2 Differentiation Time* for EXT CL 2 and par. 21-63 *Ext. 3 Differentiation Time* for EXT CL 3 are set to value 0 (zero). Normal / Inverse, par. 21-20 *Ext. 1 Normal/Inverse Control* for EXT CL 1, par. 21-40 *Ext. 2 Normal/Inverse Control* for EXT CL 2 and par. 21-60 *Ext. 3 Normal/Inverse Control* for EXT CL 3 are determined during the tuning process.

These calculated values are presented on the LCP and the user can decide whether to accept or reject them. Once accepted, the values are written to the relevant parameters and PID autotuning mode is disabled in par. 21-09 *PID Auto Tuning*. Depending on the system being controlled the time required to carry out PID autotuning could be several minutes.

Excessive feedback sensor noise should be removed using the input filter (parameter groups 6-\*\*,5-5\* and 26-\*\*, Terminal 53/54 Filter Time Constant/ Pulse Filter Time Constant #29/33) before activating PID autotuning.

**21-00 Closed Loop Type****Option:****Function:**

This parameter defines the application response. The default mode should be sufficient for most applications. If the relative application speed is known, it can be selected here. This will decrease the time needed for carrying out PID Autotuning. The setting has no impact on the value of the tuned parameters and is used only for the PID auto-tuning sequence.

[0] *	Auto
[1]	Fast Pressure
[2]	Slow Pressure
[3]	Fast Temperature
[4]	Slow Temperature

**21-02 PID Output Change****Range:****Function:**

0.10\* [0.01 - 0.50 ]

This parameter sets the magnitude of step change during autotuning. The value is a percentage of full operating range. I.e. if maximum analog output voltage is set to 10 V, 0.10 is 10% of 10 V, which is 1 V. This parameter should be set to a value resulting in feedback changes of between 10% and 20% for best tuning accuracy.

**21-03 Minimum Feedback Level****Range:****Function:**-999999.00 [Application dependant]  
0\*

The minimum allowable feedback level should be entered here in User Units as defined in par. 21-10 *Ext. 1 Ref./Feedback Unit* for EXT CL 1, par. 21-30 *Ext. 2 Ref./Feedback Unit* for EXT CL 2 or par. 21-50 *Ext. 3 Ref./Feedback Unit* for EXT CL 3. If the level falls below par. 21-03 *Minimum Feedback Level*, PID autotuning is aborted and an error message will appear on the LCP.

**21-04 Maximum Feedback Level****Range:****Function:**999999.000 [Application dependant]  
\*

The maximum allowable feedback level should be entered here in User units as defined in par. 21-10 *Ext. 1 Ref./Feedback Unit* for EXT CL 1, par. 21-30 *Ext. 2 Ref./Feedback Unit* for EXT CL 2 or par. 21-50 *Ext. 3 Ref./Feedback Unit* for EXT CL 3. If the level rises above par. 21-04 *Maximum Feedback Level*, PID autotuning is aborted and an error message will appear on the LCP.

**21-01 PID Performance****Option:****Function:**

[0] *	Normal
[1]	Fast

Normal setting of this parameter will be suitable for pressure control in fan systems.

Fast setting would generally be used in pumping systems, where a faster control response is desirable.

**21-09 PID Auto Tuning**

**Option:**

**Function:**

This parameter enables selection of the Extended PID controller to be autotuned and starts the PID autotuning for that controller. Once the autotuning has successfully completed and the settings have been accepted or rejected by the user, by pressing [OK] or [Cancel] buttons on the LCP at the end of tuning, this parameter is reset to [0] Disabled.

- [0] \* Disabled
- [1] Enabled Ext CL1 PID
- [2] Enabled Ext CL 2 PID
- [3] Enabled Ext CL 3 PID

**2.18.3 21-1\* Closed Loop 1 Ref/Feedback**

Configure Extended Closed Loop 1 Controller reference and feedback.

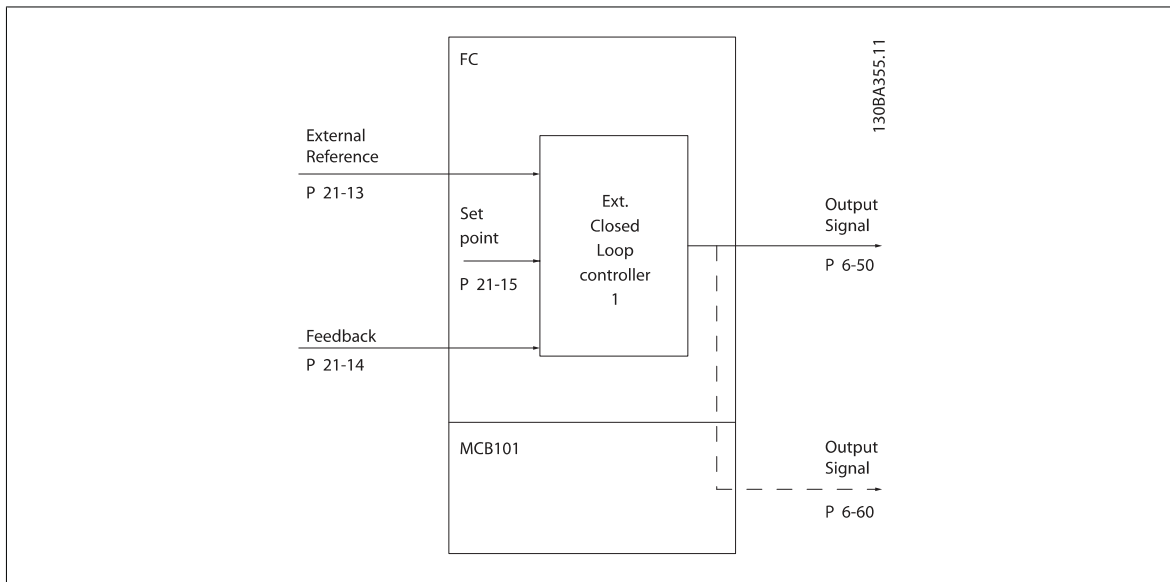

**21-10 Ext. 1 Ref./Feedback Unit**

**Option:**

**Function:**

Select the unit for the reference and feedback.

- [0] \*
- [1] \* %
- [5] PPM
- [10] 1/min
- [11] RPM
- [12] Pulse/s
- [20] l/s
- [21] l/min
- [22] l/h

## 2

[23]	m <sup>3</sup> /s
[24]	m <sup>3</sup> /min
[25]	m <sup>3</sup> /h
[30]	kg/s
[31]	kg/min
[32]	kg/h
[33]	t/min
[34]	t/h
[40]	m/s
[41]	m/min
[45]	m
[60]	°C
[70]	mbar
[71]	bar
[72]	Pa
[73]	kPa
[74]	m WG
[75]	mm Hg
[80]	kW
[120]	GPM
[121]	gal/s
[122]	gal/min
[123]	gal/h
[124]	CFM
[125]	ft <sup>3</sup> /s
[126]	ft <sup>3</sup> /min
[127]	ft <sup>3</sup> /h
[130]	lb/s
[131]	lb/min
[132]	lb/h
[140]	ft/s
[141]	ft/min
[145]	ft
[160]	°F
[170]	psi
[171]	lb/in <sup>2</sup>
[172]	in WG
[173]	ft WG
[174]	in Hg
[180]	HP

**21-11 Ext. 1 Minimum Reference**

Range:	Function:
0.000 Ex- [Application dependent] tPID1Unit*	Select the minimum for the Closed Loop 1 Controller.

**21-12 Ext. 1 Maximum Reference**

Range:	Function:
100.000 Ex- [Application dependent] tPID1Unit*	Select the maximum for the Closed Loop 1 Controller.  The dynamics of the PID controller will depend on the value set in this parameter. Please see also par. 21-21 <i>Ext. 1 Proportional Gain</i> .

**21-13 Ext. 1 Reference Source**

Option:	Function:
	This parameter defines which input on the frequency converter should be treated as the source of the reference signal for the Closed Loop 1 Controller. Analog input X30/11 and Analog input X30/12 refer to inputs on the General Purpose I/O.

- [0] \* No function
- [1] Analog input 53
- [2] Analog input 54
- [7] Pulse input 29
- [8] Pulse input 33
- [20] Digital pot.meter
- [21] Analog input X30/11
- [22] Analog input X30/12
- [23] Analog Input X42/1
- [24] Analog Input X42/3
- [25] Analog Input X42/5
- [29] Analog Input X48/2
- [30] Ext. Closed Loop 1
- [31] Ext. Closed Loop 2
- [32] Ext. Closed Loop 3

**21-14 Ext. 1 Feedback Source****Option:****Function:**

This parameter defines which input on the frequency converter should be treated as the source of the feedback signal for the Closed Loop 1 controller. Analog input X30/11 and Analog input X30/12 refer to inputs on the General Purpose I/O .

[0] *	No function
[1]	Analog input 53
[2]	Analog input 54
[3]	Pulse input 29
[4]	Pulse input 33
[7]	Analog input X30/11
[8]	Analog input X30/12
[9]	Analog Input X42/1
[10]	Analog Input X42/3
[11]	Analog Input X42/5
[15]	Analog Input X48/2
[100]	Bus feedback 1
[101]	Bus feedback 2
[102]	Bus feedback 3
[200]	Ext. Closed Loop 1
[201]	Ext. Closed Loop 2
[202]	Ext. Closed Loop 3

**21-15 Ext. 1 Setpoint****Range:****Function:**

0.000 Ex- [-999999.999 - 999999.999 Ex- tPID1Unit\* tPID1Unit] The setpoint reference is used in extended 1 closed loop. Ext.1 Setpoint is added to the value from the Ext.1 Reference source selected in par. 21-13 *Ext. 1 Reference Source*.

**21-17 Ext. 1 Reference [Unit]****Range:****Function:**

0.000 Ex- [-999999.999 - 999999.999 Ex- tPID1Unit\* tPID1Unit] Readout of the reference value for the Closed Loop 1 Controller.

**21-18 Ext. 1 Feedback [Unit]****Range:****Function:**

0.000 Ex- [-999999.999 - 999999.999 Ex- tPID1Unit\* tPID1Unit] Readout of the feedback value for the Closed Loop 1 Controller.

**21-19 Ext. 1 Output [%]****Range:****Function:**

0 %\* [0 - 100 %] Readout of the output value for the Closed Loop 1 Controller.

**2.18.4 21-2\* Closed Loop 1 PID**

Configure the Closed Loop 1 PID controller.

**21-20 Ext. 1 Normal/Inverse Control**

Option:	Function:
[0] * Normal	Select <i>Normal</i> [0] if the output should be reduced when feedback is higher than the reference.
[1] Inverse	Select <i>Inverse</i> [1] if the output should be increased when feedback is higher than the reference.

**21-21 Ext. 1 Proportional Gain**

Range:	Function:
0.50* [0.00 - 10.00 ]	

If (Error x Gain) jumps with a value equal to what is set in par. 20-14 *Maximum Reference/Feedb.*, the PID controller will try to change the output speed equal to what is set in par. 4-13/4-14, Motor Speed High Limit, but in practice of course limited by this setting.  
The proportional band (error causing output to change from 0-100%) can be calculated by means of the formula:

$$\left( \frac{1}{\text{Proportional Gain}} \right) \times (\text{Max Reference})$$

**NB!**  
Always set the desired for par. 20-14 *Maximum Reference/Feedb.* before setting the values for the PID controller in par. group 20-9\*.

**21-22 Ext. 1 Integral Time**

Range:	Function:
20.00 s* [0.01 - 10000.00 s]	Over time, the integrator accumulates a contribution to the output from the PID controller as long as there is a deviation between the Reference/Setpoint and feedback signals. The contribution is proportional to the size of the deviation. This ensures that the deviation (error) approaches zero. Quick response on any deviation is obtained when the integral time is set to a low value. Setting it too low, however, may cause the control to become unstable. The value set, is the time needed for the integrator to add the same contribution as the proportional part for a certain deviation. If the value is set to 10,000, the controller will act as a pure proportional controller with a P-band based on the value set in par. 20-93 <i>PID Proportional Gain</i> . When no deviation is present, the output from the proportional controller will be 0.

**21-23 Ext. 1 Differentiation Time**

Range:	Function:
0.00 s* [0.00 - 10.00 s]	The differentiator does not react to a constant error. It only provides a gain when the feedback changes. The quicker the feedback changes, the stronger the gain from the differentiator.

**21-24 Ext. 1 Dif. Gain Limit**

Range:	Function:
5.0* [1.0 - 50.0 ]	Set a limit for the differentiator gain (DG). The DG will increase if there are fast changes. Limit the DG to obtain a pure differentiator gain at slow changes and a constant differentiator gain where quick changes occur.

**2.18.5 21-3\* Closed Loop 2 Ref/Fb**

Configure Extended Closed Loop 2 Controller reference and feedback.

**21-30 Ext. 2 Ref./Feedback Unit**

Option:	Function:
	See par. 21-10 <i>Ext. 1 Ref./Feedback Unit</i> for details

## 2

[0] *	
[1] *	%
[5]	PPM
[10]	1/min
[11]	RPM
[12]	Pulse/s
[20]	l/s
[21]	l/min
[22]	l/h
[23]	m <sup>3</sup> /s
[24]	m <sup>3</sup> /min
[25]	m <sup>3</sup> /h
[30]	kg/s
[31]	kg/min
[32]	kg/h
[33]	t/min
[34]	t/h
[40]	m/s
[41]	m/min
[45]	m
[60]	°C
[70]	mbar
[71]	bar
[72]	Pa
[73]	kPa
[74]	m WG
[75]	mm Hg
[80]	kW
[120]	GPM
[121]	gal/s
[122]	gal/min
[123]	gal/h
[124]	CFM
[125]	ft <sup>3</sup> /s
[126]	ft <sup>3</sup> /min
[127]	ft <sup>3</sup> /h
[130]	lb/s
[131]	lb/min
[132]	lb/h
[140]	ft/s
[141]	ft/min
[145]	ft
[160]	°F

[170]	psi
[171]	lb/in <sup>2</sup>
[172]	in WG
[173]	ft WG
[174]	in Hg
[180]	HP

**21-31 Ext. 2 Minimum Reference**

Range:	Function:
0.000 Ex- [Application dependant] tPID2Unit*	See par. 21-11 <i>Ext. 1 Minimum Reference</i> for details.

**21-32 Ext. 2 Maximum Reference**

Range:	Function:
100.000 Ex- [Application dependant] tPID2Unit*	See par. 21-12 <i>Ext. 1 Maximum Reference</i> for details.

**21-33 Ext. 2 Reference Source**

Option:	Function:
	See par. 21-13 <i>Ext. 1 Reference Source</i> for details.

[0] *	No function
[1]	Analog input 53
[2]	Analog input 54
[7]	Pulse input 29
[8]	Pulse input 33
[20]	Digital pot.meter
[21]	Analog input X30/11
[22]	Analog input X30/12
[23]	Analog Input X42/1
[24]	Analog Input X42/3
[25]	Analog Input X42/5
[29]	Analog Input X48/2
[30]	Ext. Closed Loop 1
[31]	Ext. Closed Loop 2
[32]	Ext. Closed Loop 3

**21-34 Ext. 2 Feedback Source****Option:****Function:**See par. 21-14 *Ext. 1 Feedback Source* for details.

[0] *	No function
[1]	Analog input 53
[2]	Analog input 54
[3]	Pulse input 29
[4]	Pulse input 33
[7]	Analog input X30/11
[8]	Analog input X30/12
[9]	Analog Input X42/1
[10]	Analog Input X42/3
[11]	Analog Input X42/5
[15]	Analog Input X48/2
[100]	Bus feedback 1
[101]	Bus feedback 2
[102]	Bus feedback 3
[200]	Ext. Closed Loop 1
[201]	Ext. Closed Loop 2
[202]	Ext. Closed Loop 3

**21-35 Ext. 2 Setpoint****Range:****Function:**0.000 Ex- [-999999.999 - 999999.999 Ex- tPID2Unit\* tPID2Unit] See par. 21-15 *Ext. 1 Setpoint* for details.**21-37 Ext. 2 Reference [Unit]****Range:****Function:**0.000 Ex- [-999999.999 - 999999.999 Ex- tPID2Unit\* tPID2Unit] See par. 21-17 *Ext. 1 Reference [Unit], Ext. 1 Reference [Unit]*, for details.**21-38 Ext. 2 Feedback [Unit]****Range:****Function:**0.000 Ex- [-999999.999 - 999999.999 Ex- tPID2Unit\* tPID2Unit] See par. 21-18 *Ext. 1 Feedback [Unit]* for details.**21-39 Ext. 2 Output [%]****Range:****Function:**0 %\* [0 - 100 %] See par. 21-19 *Ext. 1 Output [%]* for details.**2.18.6 21-4\* Closed Loop 2 PID**

Configure the Closed Loop 2 PID Controller.

**21-40 Ext. 2 Normal/Inverse Control**

Option:	Function:
	See par. 21-20 <i>Ext. 1 Normal/Inverse Control</i> for details.
[0] * Normal	
[1] Inverse	

**21-41 Ext. 2 Proportional Gain**

Range:	Function:
0.50* [0.00 - 10.00 ]	See par. 21-21 <i>Ext. 1 Proportional Gain</i> for details.

**21-42 Ext. 2 Integral Time**

Range:	Function:
20.00 s* [0.01 - 10000.00 s]	See par. 21-22 <i>Ext. 1 Integral Time</i> for details.

**21-43 Ext. 2 Differentiation Time**

Range:	Function:
0.00 s* [0.00 - 10.00 s]	See par. 21-23 <i>Ext. 1 Differentiation Time</i> for details.

**21-44 Ext. 2 Dif. Gain Limit**

Range:	Function:
5.0* [1.0 - 50.0 ]	See par. 21-24 <i>Ext. 1 Dif. Gain Limit</i> for details.

**2.18.7 21-5\* Closed Loop 3 Ref/Fb**

Configure Extended Closed Loop 3 Controller reference and feedback.

**21-50 Ext. 3 Ref./Feedback Unit**

Option:	Function:
	See par. 21-10 <i>Ext. 1 Ref./Feedback Unit</i> for details.
[0] *	
[1] * %	
[5] PPM	
[10] 1/min	
[11] RPM	
[12] Pulse/s	
[20] l/s	
[21] l/min	
[22] l/h	
[23] m <sup>3</sup> /s	
[24] m <sup>3</sup> /min	
[25] m <sup>3</sup> /h	
[30] kg/s	
[31] kg/min	
[32] kg/h	
[33] t/min	

[34]	t/h
[40]	m/s
[41]	m/min
[45]	m
[60]	°C
[70]	mbar
[71]	bar
[72]	Pa
[73]	kPa
[74]	m WG
[75]	mm Hg
[80]	kW
[120]	GPM
[121]	gal/s
[122]	gal/min
[123]	gal/h
[124]	CFM
[125]	ft <sup>3</sup> /s
[126]	ft <sup>3</sup> /min
[127]	ft <sup>3</sup> /h
[130]	lb/s
[131]	lb/min
[132]	lb/h
[140]	ft/s
[141]	ft/min
[145]	ft
[160]	°F
[170]	psi
[171]	lb/in <sup>2</sup>
[172]	in WG
[173]	ft WG
[174]	in Hg
[180]	HP

**21-51 Ext. 3 Minimum Reference****Range:**0.000 Ex- [Application dependant]  
tPID3Unit\***Function:**See par. 21-11 *Ext. 1 Minimum Reference* for details.**21-52 Ext. 3 Maximum Reference****Range:**100.000 Ex- [Application dependant]  
tPID3Unit\***Function:**See par. 21-12 *Ext. 1 Maximum Reference* for details.

**21-53 Ext. 3 Reference Source**

Option:	Function:
See par. 21-13 <i>Ext. 1 Reference Source</i> for details.	
[0] *	No function
[1]	Analog input 53
[2]	Analog input 54
[7]	Pulse input 29
[8]	Pulse input 33
[20]	Digital pot.meter
[21]	Analog input X30/11
[22]	Analog input X30/12
[23]	Analog Input X42/1
[24]	Analog Input X42/3
[25]	Analog Input X42/5
[29]	Analog Input X48/2
[30]	Ext. Closed Loop 1
[31]	Ext. Closed Loop 2
[32]	Ext. Closed Loop 3

**21-54 Ext. 3 Feedback Source**

Option:	Function:
See par. 21-14 <i>Ext. 1 Feedback Source</i> for details.	
[0] *	No function
[1]	Analog input 53
[2]	Analog input 54
[3]	Pulse input 29
[4]	Pulse input 33
[7]	Analog input X30/11
[8]	Analog input X30/12
[9]	Analog Input X42/1
[10]	Analog Input X42/3
[11]	Analog Input X42/5
[15]	Analog Input X48/2
[100]	Bus feedback 1
[101]	Bus feedback 2
[102]	Bus feedback 3
[200]	Ext. Closed Loop 1
[201]	Ext. Closed Loop 2
[202]	Ext. Closed Loop 3

**21-55 Ext. 3 Setpoint**

Range:	Function:
0.000 Ex- [-999999.999 - 999999.999 Ex- tPID3Unit* tPID3Unit]	See par. 21-15 <i>Ext. 1 Setpoint</i> for details.

## 2

**21-57 Ext. 3 Reference [Unit]****Range:**0.000 Ex- [-999999.999 - 999999.999 Ex-  
tPID3Unit\* tPID3Unit]**Function:**See par. 21-17 *Ext. 1 Reference [Unit]* for details.**21-58 Ext. 3 Feedback [Unit]****Range:**0.000 Ex- [-999999.999 - 999999.999 Ex-  
tPID3Unit\* tPID3Unit]**Function:**See par. 21-18 *Ext. 1 Feedback [Unit]* for details.**21-59 Ext. 3 Output [%]****Range:**

0 %\* [0 - 100 %]

**Function:**See par. 21-19 *Ext. 1 Output [%]* for details.**2.18.8 21-6\* Closed Loop 3 PID**

Configure the Closed Loop 3 PID Controller.

**21-60 Ext. 3 Normal/Inverse Control****Option:**

[0] \* Normal

[1] Inverse

**Function:**See par. 21-20 *Ext. 1 Normal/Inverse Control* for details.**21-61 Ext. 3 Proportional Gain****Range:**

0.50\* [0.00 - 10.00 ]

**Function:**See par. 21-21 *Ext. 1 Proportional Gain* for details.**21-62 Ext. 3 Integral Time****Range:**

20.00 s\* [0.01 - 10000.00 s]

**Function:**See par. 21-22 *Ext. 1 Integral Time* for details.**21-63 Ext. 3 Differentiation Time****Range:**

0.00 s\* [0.00 - 10.00 s]

**Function:**See par. 21-23 *Ext. 1 Differentiation Time* for details.**21-64 Ext. 3 Dif. Gain Limit****Range:**

5.0\* [1.0 - 50.0 ]

**Function:**See par. 21-24 *Ext. 1 Dif. Gain Limit* for details.

## 2.18 Main Menu - Application Functions - Group 22

### 2.19.1 22-\*\* Miscellaneous

This group contains parameters used for monitoring water/ wastewater applications.

#### 22-00 External Interlock Delay

**Range:**

0 s\* [0 - 600 s]

**Function:**

Only relevant if one of the digital inputs in par. 5-1\* has been programmed for *External Interlock* [7]. The External Interlock Timer will introduce a delay after the signal has been removed from the digital input programmed for External Interlock, before reaction takes place.

### 2.19.2 22-2\* No-Flow Detection

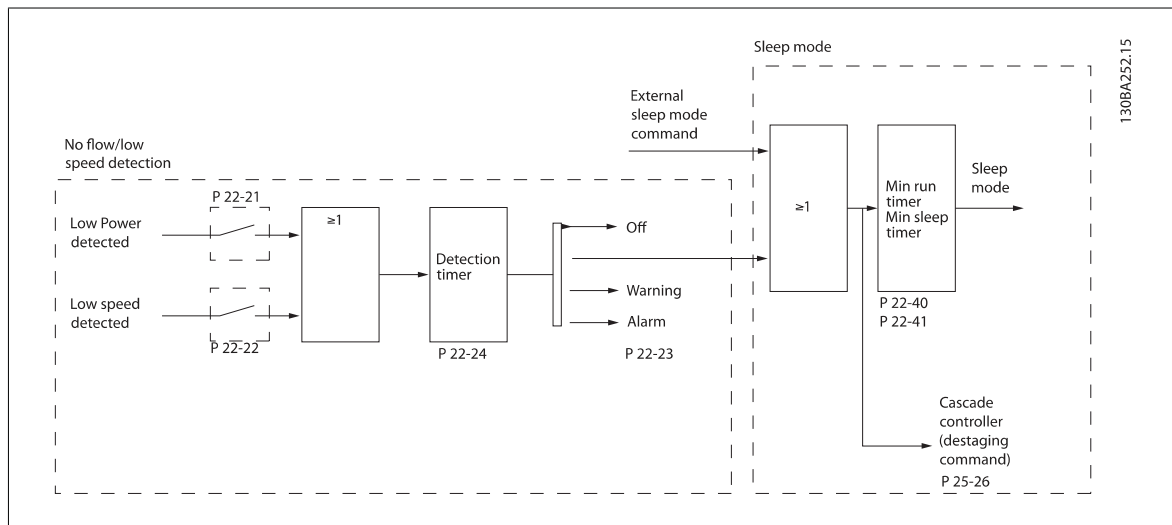

The VLT Automation VT Drive includes functions for detecting if the load conditions in the system allow the motor to be stopped:

\*Low Power Detection

\*Low Speed Detection

One of these two signals must be active for a set time (No Flow Delay par. 22-24) before selected action takes place. Possible actions to select (par. 22-23): No action, Warning, Alarm, Sleep Mode.

No Flow Detection:

This function is used for detecting a no flow situation in pump systems where all valves can be closed. Can be used both when controlled by the integrated PI controller in VLT Automation VT Drive or an external PI controller. Actual configuration must be programmed in par. 1-00, *Configuration Mode*.

Configuration mode for

- Integrated PI Controller: Closed Loop
- External PI Controller: Open Loop

Carry out No Flow tuning before setting the PI controller parameters!

## 2

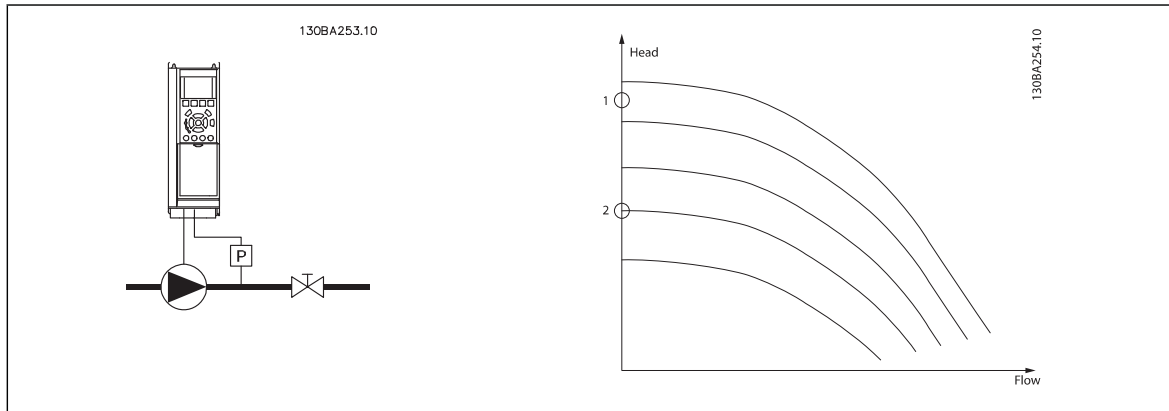

*No Flow Detection* is based on the measurement of speed and power. For a certain speed the frequency converter calculates the power at no flow. This coherence is based on the adjustment of two sets of speed and associated power at no flow. By monitoring the power it is possible to detect no flow conditions in systems with fluctuating suction pressure or if the pump has a flat characteristic towards low speed.

The two sets of data must be based on measurement of power at approx. 50% and 85% of maximum speed with the valve(s) closed. The data are programmed in the par. 22-3\*. It is also possible to run a *Low Power Auto Set Up* (par. 22-20), automatically stepping through the commissioning process and also automatically storing the data measured. The frequency converter must be set for Open Loop in par. 1-00, *Configuration Mode*, when carrying out the Auto Set Up (See No Flow Tuning par. 22-3\*).



If to use the integrated PI controller, carry out No Flow tuning before setting the PI controller parameters!

#### Low speed detection:

*Low Speed Detection* gives a signal if the motor is operating with minimum speed as set in par. 4-11 or 4-12, *Motor Low Limit*. Actions are common with No Flow Detection (individual selection not possible).

The use of Low Speed Detection is not limited to systems with a no flow situation, but can be used in any system where operation at minimum speed allows for a stop of the motor until the load calls for a speed higher than minimum speed, e.g. systems with fans and compressors.



In pump systems ensure that the minimum speed in par. 4-11 or 4-12 has been set high enough for detection as the pump can run with a rather high speed even with valves closed.

#### Dry pump detection:

*No Flow Detection* can also be used for detecting if the pump has run dry (low power consumption-high speed). Can be used with both the integrated PI controller and an external PI controller.

The condition for Dry Pump signal:

- Power consumption below no flow level

and

- Pump running at maximum speed or maximum reference open loop, whichever is lowest.

The signal must be active for a set time (*Dry Pump Delay* par. 22-27) before selected the action takes place.

Possible Actions to select (par. 22-26):

- Warning
- Alarm

No Flow Detection must be enabled (par. 22-23, *No Flow Function*) and commissioned (par. 22-3\*, *No Power Tuning*).

**22-20 Low Power Auto Set-up**

Option:	Function:
[0] * Off	When set for <i>Enabled</i> , an auto set up sequence is activated, automatically setting speed to approx. 50 and 85% of rated motor speed (par. 4-13 <i>Motor Speed High Limit [RPM]</i> , par. 4-14 <i>Motor Speed High Limit [Hz]</i> ). At those two speeds, the power consumption is automatically measured and stored. Before enabling Auto Set Up: <ol style="list-style-type: none"> <li>1. Close valve(s) in order to create a no flow condition</li> <li>2. The frequency converter must be set for Open Loop (par. 1-00 <i>Configuration Mode</i>). Note that it is important also to set par. 1-03 <i>Torque Characteristics</i>.</li> </ol>
[1] Enabled	

 **NB!**  
Auto Set Up must be done when the system has reached normal operating temperature!

 **NB!**  
It is important that the par. 4-13 *Motor Speed High Limit [RPM]* or par. 4-14 *Motor Speed High Limit [Hz]* is set to the max. operational speed of the motor!  
It is important to do the Auto Set-up before configuring the integrated PI Controller as settings will be reset when changing from Closed to Open Loop in par. 1-00 *Configuration Mode*.

 **NB!**  
Carry out the tuning with the same settings in par. 1-03 *Torque Characteristics*, as for operation after the tuning.

**22-21 Low Power Detection**

Option:	Function:
[0] * Disabled	If selecting Enabled, the Low Power Detection commissioning must be carried out in order to set the parameters in group 22-3* for proper operation!
[1] Enabled	

**22-22 Low Speed Detection**

Option:	Function:
[0] * Disabled	Select Enabled for detecting when the motor operates with a speed as set in par. 4-11 <i>Motor Speed Low Limit [RPM]</i> or par. 4-12 <i>Motor Speed Low Limit [Hz]</i> .
[1] Enabled	

**22-23 No-Flow Function****Option:****Function:**

Common actions for Low Power Detection and Low Speed Detection (Individual selections not possible).

[0] \* Off

[1] Sleep Mode

[2] Warning Messages in the Local Control Panel display (if mounted) and/or signal via a relay or a digital output.

[3] Alarm The frequency converter trips and motor stays stopped until reset.

**22-24 No-Flow Delay****Range:****Function:**

10 s\* [1 - 600 s]

Set the time Low Power/Low Speed must stay detected to activate signal for actions. If detection disappears before run out of the timer, the timer will be reset.

**22-26 Dry Pump Function****Option:****Function:**

*Low Power Detection* must be Enabled (par. 22-21 *Low Power Detection*) and commissioned (using either par. 22-3\*, *No Flow Power Tuning*, or par. 22-20 *Low Power Auto Set-up*) in order to use Dry Pump Detection.

[0] \* Off

[1] Warning Messages in the Local Control Panel display (if mounted) and/or signal via a relay or a digital output.

[2] Alarm The frequency converter trips and motor stays stopped until reset.

[3] Manual Reset Alarm

**22-27 Dry Pump Delay****Range:****Function:**

10 s\* [0 - 600 s]

Defines for how long the Dry Pump condition must be active before activating Warning or Alarm

**22-28 No-Flow Low Speed [RPM]****Range:****Function:**

0\* [Motor Min. Speed - Motor Max. Speed]

Used to set the speed for no-flow low speed detection.

If a low speed detection at a speed different from the motor minimum speed is needed, this parameter may be used.

**22-29 No-Flow Low Speed [Hz]****Range:****Function:**

0\* [Motor Min. Speed - Motor Max. Speed]

Used to set the speed for no-flow low speed detection.

If a low speed detection at a speed different from the motor minimum speed is needed, this parameter may be used.

**2.19.3 22-3\* No-Flow Power Tuning**

Tuning Sequence, if not choosing *Auto Set Up* in par. 22-20 *Low Power Auto Set-up*.

1. Close the main valve to stop flow
2. Run with motor until the system has reached normal operating temperature

3. Press Hand On button on the LCP and adjust speed for approx. 85% of rated speed. Note the exact speed
4. Read power consumption either by looking for actual power in the data line in the LCP or call par. 16-10 *Power [kW]* or par. 16-11 *Power [hp]* in Main Menu. Note the power read out
5. Change speed to approx. 50% of rated speed. Note the exact speed
6. Read power consumption either by looking for actual power in the data line in the LCP or call par. 16-10 *Power [kW]* or par. 16-11 *Power [hp]* in Main Menu. Note the power read
7. Program the speeds used in par. 22-32 *Low Speed [RPM]*, par. 22-33 *Low Speed [Hz]*, par. 22-36 *High Speed [RPM]* and par. 22-37 *High Speed [Hz]*
8. Program the associated power values in par. 22-34 *Low Speed Power [kW]*, par. 22-35 *Low Speed Power [HP]*, par. 22-38 *High Speed Power [kW]* and par. 22-39 *High Speed Power [HP]*
9. Switch back by means of *Auto On* or *Off*

**NB!**  
Set par. 1-03 *Torque Characteristics* before tuning takes place.

**22-30 No-Flow Power**

<b>Range:</b>	<b>Function:</b>	
0.00 kW* [0.00 - 0.00 kW]	Read out of calculated No Flow power at actual speed. If power drops to the display value the frequency converter will consider the condition as a No Flow situation.	

**22-31 Power Correction Factor**

<b>Range:</b>	<b>Function:</b>	
100 %* [1 - 400 %]	Make corrections to the calculated power at par. 22-30 <i>No-Flow Power</i> . If No Flow is detected, when it should not be detected, the setting should be decreased. However, if No Flow is not detected, when it should be detected, the setting should be increased to above 100%.	

**22-32 Low Speed [RPM]**

<b>Range:</b>	<b>Function:</b>	
Application [Application dependant] dependent*		

**22-33 Low Speed [Hz]**

<b>Range:</b>	<b>Function:</b>	
Application [Application dependant] dependent*		

**22-34 Low Speed Power [kW]**

<b>Range:</b>	<b>Function:</b>	
Application [Application dependant] dependent*		

**22-35 Low Speed Power [HP]**

<b>Range:</b>	<b>Function:</b>	
Application [Application dependant] dependent*		

**22-36 High Speed [RPM]****Range:** **Function:**Application [Application dependant]  
dependent\***22-37 High Speed [Hz]****Range:** **Function:**Application [Application dependant]  
dependent\***22-38 High Speed Power [kW]****Range:** **Function:**Application [Application dependant]  
dependent\***22-39 High Speed Power [HP]****Range:** **Function:**Application [Application dependant]  
dependent\***2.19.4 22-4\* Sleep Mode**

If the load on the system allows for stop of the motor and the load is monitored, the motor can be stopped by activating the Sleep Mode function. This is not a normal Stop command, but ramps the motor down to 0 RPM and stops energizing the motor. When in Sleep Mode certain conditions are monitored to find out when load has been applied to the system again.

Sleep Mode can be activated either from the No Flow Detection/Minimum Speed Detection or via an external signal applied to one of the digital inputs (must be programmed via the parameters for configuration of the digital inputs, par. 5-1\* selecting Sleep Mode).

To make it possible to use e.g. an electro-mechanical flow switch to detect a no flow condition and activate Sleep Mode, the action takes place at raising edge of the external signal applied (otherwise the frequency converter would never come out of Sleep Mode again as the signal would be steady connected).

If par. 25-26, *Destage at No-Flow*, is set for Enabled activating Sleep Mode will apply a command to the cascade controller (if enabled) to start de-staging of lag pumps (fixed speed) before stopping the lead pump (variable speed).

When entering Sleep Mode, the lower status line in the Local Control Panel shows Sleep Mode.

See also signal flow chart in section 22-2\* *No Flow Detection*.

There are three different ways of using the Sleep Mode function:

2

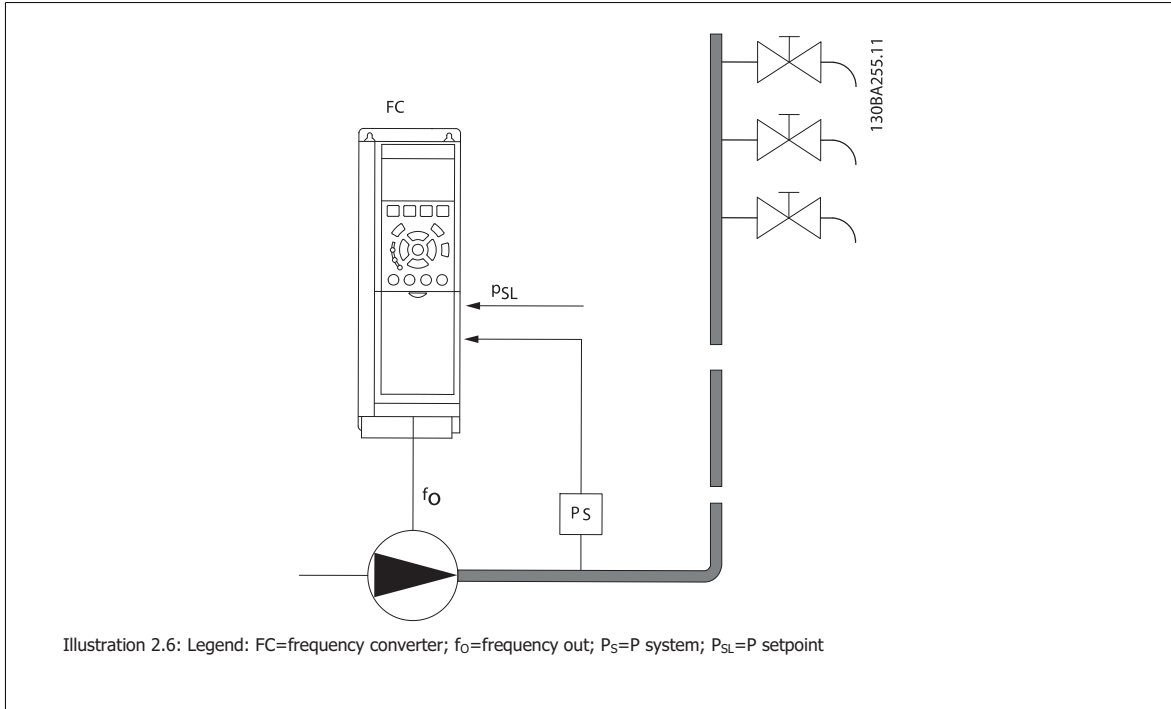

1) Systems where the integrated PI controller is used for controlling pressure or temperature e.g. boost systems with a pressure feed back signal applied to the frequency converter from a pressure transducer. Par. 1-00, *Configuration Mode*, must be set for Closed Loop and the PI Controller configured for desired reference and feed back signals.

Example: Boost system.

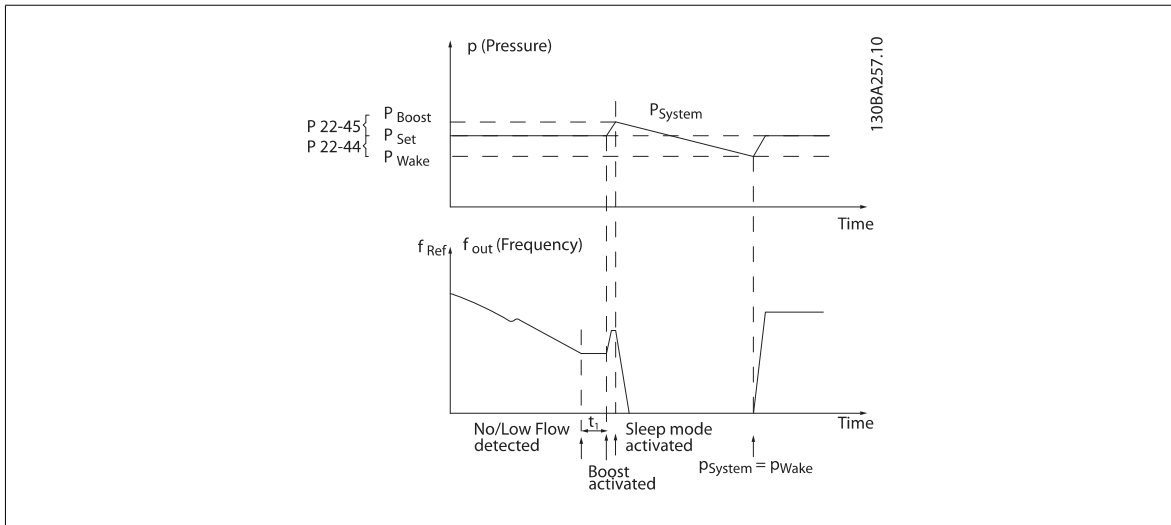

If no flow is detected, the frequency converter will increase the set point for pressure to ensure a slight over pressure in the system (boost to be set in par. 22-45, *Setpoint Boost*).

The feedback from the pressure transducer is monitored and when this pressure has dropped with a set percentage below the normal set point for pressure (Pset), the motor will ramp up again and pressure will be controlled for reaching the set value (Pset).

**2**

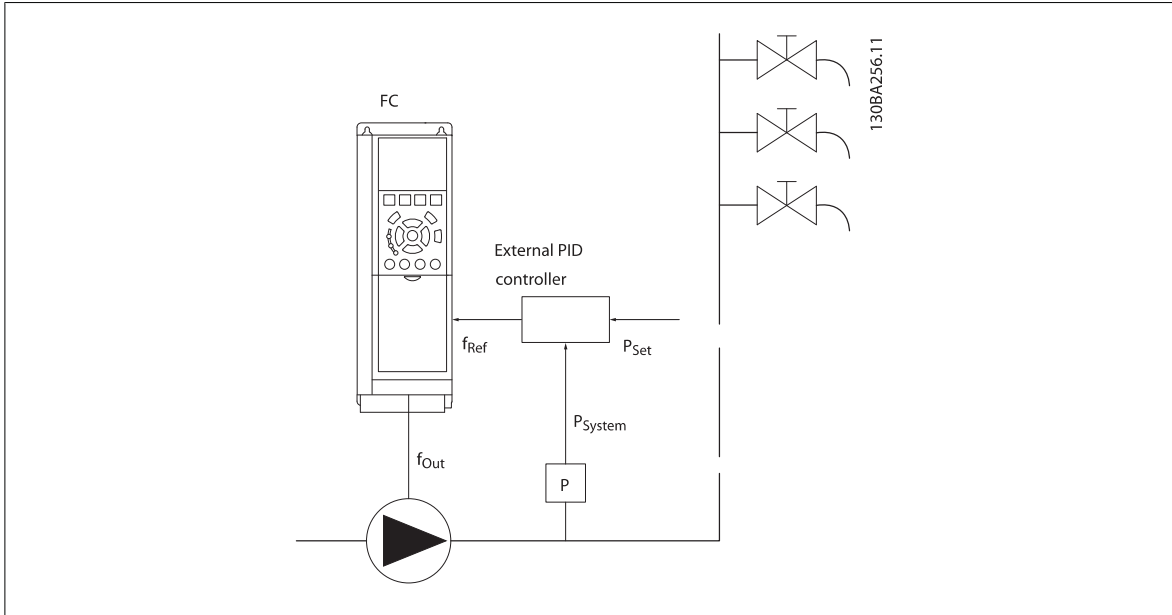

2) In systems where the pressure or temperature is controlled by an external PI controller, the wake up conditions can not be based on feedback from the pressure/temperature transducer as the setpoint is not known. In the example with a boost system, desired pressure  $P_{Set}$  is not known. Par. 1-00, *Configuration mode*, must be set for Open Loop.  
Example: Boost system.

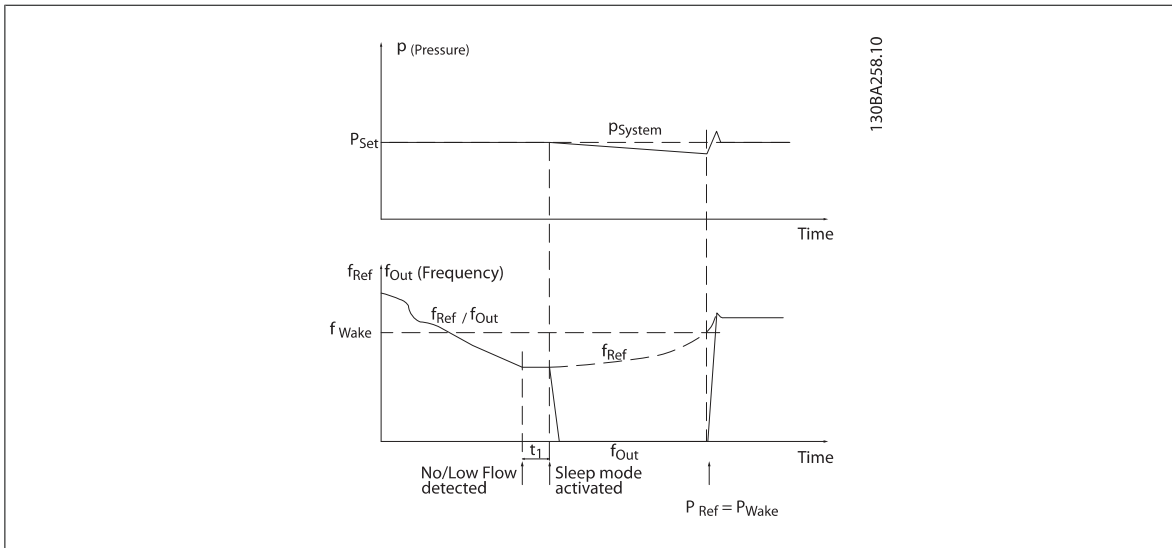

When low power or low speed is detected the motor is stopped, but the reference signal ( $f_{ref}$ ) from the external controller is still monitored and because of the low pressure created, the controller will increase the reference signal to gain pressure. When the reference signal has reached a set value  $f_{wake}$  the motor restarts.

The speed is set manually by an external reference signal (Remote Reference). The settings (par. 22-3\*) for tuning of the No Flow function must be set to default.

Configuration possibilities, overview:

	Internal PI Controller (Par. 1-00: Closed loop)		External PI Controller or manual control (Par. 1-00: Open loop)	
	Sleep mode	Wake up	Sleep mode	Wake up
No Flow detection (pumps only)	Yes		Yes (except manual setting of speed)	
Low speed detection	Yes		Yes	
External signal	Yes		Yes	
Pressure/Temperature (transmitter connected)		Yes		No
Output frequency		No		Yes

 **NB!**  
Sleep Mode will not be active when Local Reference is active (set speed manually by means of arrow buttons on the Local Control Panel). See Par. 3-13, *Reference Site*.  
Does not work in Hand-mode. Auto set-up in open loop must be carried out before setting input/output in closed loop.

### 22-40 Minimum Run Time

**Range:**

60 s\* [0 - 600 s]

**Function:**

Set the desired minimum running time for the motor after a start command (digital input or Bus) before entering Sleep Mode.

### 22-41 Minimum Sleep Time

**Range:**

30 s\* [0 - 600 s]

**Function:**

Set the desired Minimum Time for staying in Sleep Mode. This will override any wake up conditions.

### 22-42 Wake-up Speed [RPM]

**Range:**

Application [Application dependant] dependent\*

**Function:**

### 22-43 Wake-up Speed [Hz]

**Range:**

Application [Application dependant] dependent\*

**Function:**

### 22-44 Wake-up Ref./FB Difference

**Range:**

10%\* [0-100%]

**Function:**

Only to be used if par. 1-00, *Configuration Mode*, is set for Closed Loop and the integrated PI controller is used for controlling the pressure.  
Set the pressure drop allowed in percentage of set point for the pressure (Pset) before cancelling the Sleep Mode.

 **NB!**  
If used in application where the integrated PI controller is set for inverse control in par. 20-71, *PID, Normal/Inverse Control*, the value set in par. 22-44 will automatically be added.

**22-45 Setpoint Boost****Range:**

0 %\* [-100 - 100 %]

**Function:**

Only to be used if par. 1-00 *Configuration Mode*, is set for Closed Loop and the integrated PI controller is used. In systems with e.g. constant pressure control, it is advantageous to increase the system pressure before the motor is stopped. This will extend the time in which the motor is stopped and help to avoid frequent start/stop.

Set the desired over pressure/temperature in percentage of set point for the pressure (Pset)/temperature before entering the Sleep Mode.

If setting for 5%, the boost pressure will be Pset\*1.05. The negative values can be used for e.g. cooling tower control where a negative change is needed.

**22-46 Maximum Boost Time****Range:**

60 s\* [0 - 600 s]

**Function:**

Only to be used if par. 1-00 *Configuration Mode* is set for Closed Loop and the integrated PI controller is used for controlling the pressure.

Set the maximum time for which boost mode will be allowed. If the set time is exceeded, Sleep Mode will be entered, not waiting for the set boost pressure to be reached.

**2.19.5 22-5\* End of Curve**

The End of Curve conditions occur when a pump is yielding a too large volume to ensure the set pressure. This can occur if there is a leakage in the distribution pipe system after the pump causing the pump to operate at the end of the pump characteristic, valid for the max. speed set in par. 4-13 *Motor Speed High Limit [RPM]* or par. 4-14 *Motor Speed High Limit [Hz]*.

In case the feed back is 2.5% of the programmed value in par. 20-14 *Maximum Reference/Feedb.* (or numerical value of par. 20-13 *Minimum Reference/Feedb.* whichever is highest) below the set point for the desired pressure for a set time (par. 22-51 *End of Curve Delay*), and the pump is running with max. speed set in par. 4-13 *Motor Speed High Limit [RPM]* or par. 4-14 *Motor Speed High Limit [Hz]*, - the function selected in par. 22-50 *End of Curve Function* will take place.

It is possible to get a signal on one of the digital outputs by selecting End of Curve [192] in par. 5-3\* *Digital Outputs* and/or par. 5-4\* *Relays*. The signal will be present, when an End of Curve condition occurs and the selection in par. 22-50 *End of Curve Function*, is different from Off. The end of curve function can only be used when operating with the built-in PID controller (Closed loop in par. 1-00 *Configuration Mode*).

**22-50 End of Curve Function****Option:**

[0] \* Off

**Function:**

End of Curve monitoring not active.

[1] Warning

A warning is issued in the display [W94].

[2] Alarm

An alarm is issued and the frequency converter trips. A message [A94] appears in the display.

[3] Manual Reset Alarm

**NB!**

Automatic restart will reset the alarm and start the system again.

**22-51 End of Curve Delay****Range:**

10 s\* [0 - 600 s]

**Function:**

When an End of Curve condition is detected, a timer is activated. When the time set in this parameter expires, and the End of Curve condition has been steady in the entire period, the function set in par. 22-50 *End of Curve Function* will be activated. If the condition disappears before the timer expires, the timer will be reset.

### 2.19.6 22-6\* Broken Belt Detection

The Broken Belt Detection can be used in both closed and open loop systems for pumps and fans. If the estimated motor torque is below the broken belt torque value (par. 22-61) and the frequency converter output frequency is above or equal to 15 Hz, the broken belt function (par. 22-60) is performed

#### 22-60 Broken Belt Function

Option:	Function:
	Selects the action to be performed if the Broken Belt condition is detected
[0] *    Off	
[1]        Warning	
[2]        Trip	

#### 22-61 Broken Belt Torque

Range:	Function:
10 %*    [0 - 100 %]	Sets the broken belt torque as a percentage of the rated motor torque.

#### 22-62 Broken Belt Delay

Range:	Function:
10 s        [0 - 600 s]	Sets the time for which the Broken Belt conditions must be active before carrying out the action selected in par. 22-60 <i>Broken Belt Function</i> .

### 2.19.7 22-7\* Short Cycle Protection

In some applications, there will often be a need for limiting the numbers of starts. One way to do this is to ensure a minimum run time (time between a start and a stop) and a minimum interval between starts.

This means that any normal stop command can be overridden by the *Minimum Run Time* function (par. 22-77) and any normal start command (Start/Jog/Freeze) can be overridden by the *Interval Between Starts* function (par. 22-76).

None of the two functions are active if *Hand On* or *Off* modes have been activated via the LCP. If selecting *Hand On* or *Off*, the two timers will be reset to 0, and not start counting until *Auto* is pressed and an active start command applied.

#### 22-75 Short Cycle Protection

Option:	Function:
[0] *    Disabled	Timer set in par. 22-76 <i>Interval between Starts</i> is disabled.
[1]        Enabled	Timer set in par. 22-76 <i>Interval between Starts</i> is enabled.

#### 22-76 Interval between Starts

Range:	Function:
Application dependent* dependent*	

#### 22-77 Minimum Run Time

Range:	Function:
0 s*        [Application dependent]	Sets the time desired as minimum run time after a normal start command (Start/Jog/Freeze). Any normal stop command will be disregarded until the set time has expired. The timer will start counting following a normal start command (Start/Jog/Freeze).
	The timer will be overridden by a Coast (Inverse) or an External Interlock command.

**2**

**NB!**  
Does not work in cascade mode.

**2.19.8 22-8\* Flow Compensation**

It is sometimes the case that it is not possible for a pressure transducer to be placed at a remote point in the system and it can only be located close to the fan/pump outlet. Flow compensation operates by adjusting the set-point according to the output frequency, which is almost proportional to flow, thus compensating for higher losses at higher flow rates.

H<sub>DESIGN</sub> (Required pressure) is the setpoint for closed loop (PI) operation of the frequency converter and is set as for closed loop operation without flow compensation.

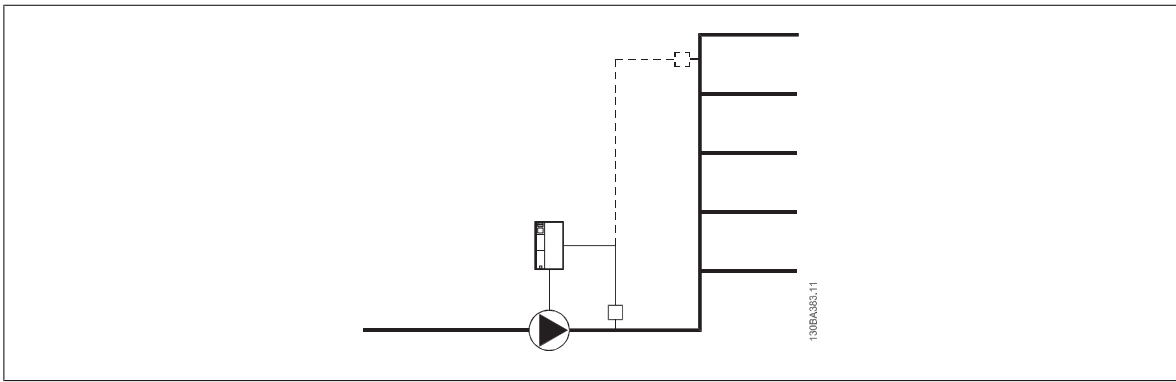

There are two methods which can be employed, depending upon whether or not the Speed at System design Working Point is known.

Parameter used	Parameter number	Speed at Design Point KNOWN	Speed at Design Point UNKNOWN
Flow Compensation	(Par 22-80)	+	+
Square-Linear Curve Approximation	(Par 22-81)	+	+
Work Point Calculation	(Par 22-82)	+	+
Speed at No Flow	(Par 22-83/84)	+	+
Speed at Design Point	(Par 22-85/86)	+	-
Pressure at No Flow	(Par 22-87)	+	+
Pressure at Rated Speed	(Par 22-88)	-	+
Flow at Design Point	(Par 22-89)	-	+
Flow at Rated Speed	(Par 22-90)	-	+

**22-80 Flow Compensation**

Option:	Function:
[0] * Disabled	[0] <i>Disabled:</i> Set-Point compensation not active.
[1] Enabled	[1] <i>Enabled:</i> Set-Point compensation is active. Enabling this parameter allows the Flow Compensated Setpoint operation.

**22-81 Square-linear Curve Approximation**

<b>Range:</b>	<b>Function:</b>
100 %* [0 - 100 %]	<b>Example 1:</b> Adjustment of this parameter allows the shape of the control curve to be adjusted. 0 = Linear 100% = Ideal shape (theoretical).

 **NB!**  
Please note: Not visible when running in cascade.

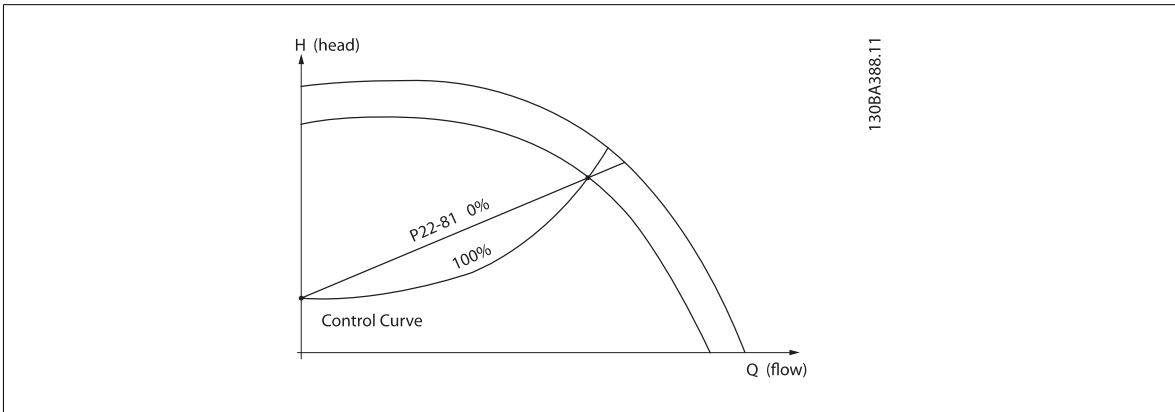

**22-82 Work Point Calculation**

<b>Option:</b>	<b>Function:</b>
----------------	------------------

**Example 1:** Speed at System Design Working Point is known:

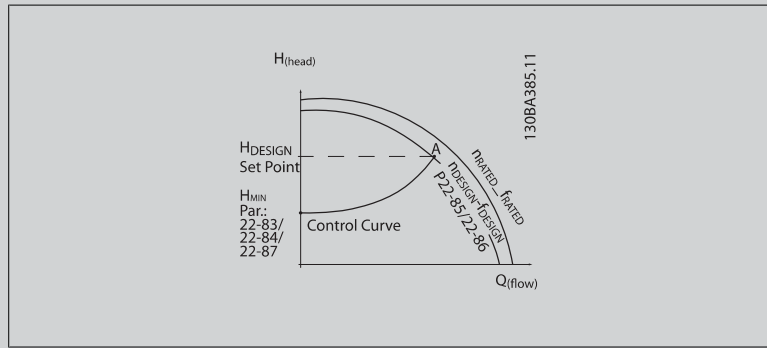

From the data sheet showing characteristics for the specific equipment at different speeds, simply reading across from the H<sub>DESIGN</sub> point and the Q<sub>DESIGN</sub> point allows us to find point A, which is the System Design Working Point. The pump characteristics at this point should be identified and the associated speed programmed. Closing the valves and adjusting the speed until H<sub>MIN</sub> has been achieved allows the speed at the no flow point to be identified.

Adjustment of par. 22-81 *Square-linear Curve Approximation* then allows the shape of the control curve to be adjusted infinitely.

**Example 2:**

2

Speed at System Design Working Point is not known: Where the Speed at System Design Working Point is unknown, another reference point on the control curve needs to be determined by means of the data sheet. By looking at the curve for the rated speed and plotting the design pressure ( $H_{DESIGN}$ , Point C) the flow at that pressure  $Q_{RATED}$  can be determined. Similarly, by plotting the design flow ( $Q_{DESIGN}$ , Point D), the pressure  $H_D$  at that flow can be determined. Knowing these two points on the pump curve, along with  $H_{MIN}$  as described above, allows the frequency converter to calculate the reference point B and thus to plot the control curve which will also include the System design Working Point A.

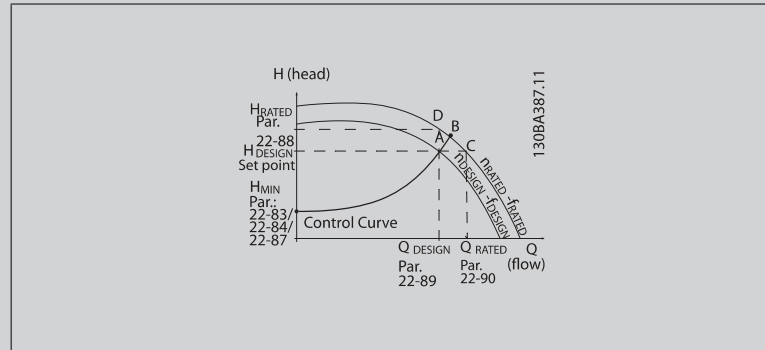

- [0] \* Disabled *Disabled [0]:* Work Point Calculation not active. To be used if speed at design point is known (see table above).
- [1] Enabled *Enabled [1]:* Work Point Calculation is active. Enabling this parameter allows the calculation of the unknown System Design Working Point at 50/60 Hz speed, from the input data set in par. 22-83 *Speed at No-Flow [RPM]* par. 22-84 *Speed at No-Flow [Hz]*, par. 22-87 *Pressure at No-Flow Speed*, par. 22-88 *Pressure at Rated Speed*, par. 22-89 *Flow at Design Point* and par. 22-90 *Flow at Rated Speed*.

**22-83 Speed at No-Flow [RPM]**

**Range:** Application [Application dependant] dependent\* **Function:**

**22-84 Speed at No-Flow [Hz]**

**Range:** Application [Application dependant] dependent\* **Function:**

**22-85 Speed at Design Point [RPM]**

**Range:** Application [Application dependant] dependent\* **Function:**

**22-86 Speed at Design Point [Hz]**

**Range:** Application [Application dependant] dependent\* **Function:**

**22-87 Pressure at No-Flow Speed**

**Range:**

0.000\* [Application dependant]

**Function:**

Enter the pressure  $H_{MIN}$  corresponding to Speed at No Flow in Reference/Feedback Units.

**22-88 Pressure at Rated Speed**

**Range:**

999999.999 [Application dependant]  
\*

**Function:**

Enter the value corresponding to the Pressure at Rated Speed, in Reference/Feedback Units. This value can be defined using the pump datasheet.

**22-90 Flow at Rated Speed**

**Range:**

0.000\* [0.000 - 999999.999 ]

**Function:**

Enter the value corresponding to Flow at Rated Speed. This value can be defined using the pump datasheet.

## 2.19 Main Menu - Time-based Functions - Group 23

### 2.20.1 23-0\* Timed Actions

2

Use *Timed Actions* for actions needing to be performed on a daily or weekly basis, e.g. different references for working hours / non-working hours. Up to 10 Timed Actions can be programmed in the frequency converter. The Timed Action number is selected from the list when entering parameter group 23-0\* from the LCP. par. 23-00 *ON Time* – par. 23-04 *Occurrence* then refer to the selected Timed Action number. Each Timed Action is divided into an ON time and an OFF time, in which two different actions may be performed.

**NB!**

The clock (parameter group 0-7\*) must be correctly programmed for Timed Actions to function correctly.

**NB!**

When mounting an Analog I/O MCB109 option card, a battery back up of the date and time is included.

#### 23-00 ON Time

Array [10]

**Range:**

Application [Application dependant]  
dependent\*

**Function:**

#### 23-01 ON Action

Arra [10]

**Option:****Function:**

Select the action during ON Time. See par. 13-52 *SL Controller Action* for descriptions of the options.

[0] \* Disabled

[1] No action

[2] Select set-up 1

[3] Select set-up 2

[4] Select set-up 3

[5] Select set-up 4

[10] Select preset ref 0

[11] Select preset ref 1

[12] Select preset ref 2

[13] Select preset ref 3

[14] Select preset ref 4

[15] Select preset ref 5

[16] Select preset ref 6

[17] Select preset ref 7

[18] Select ramp 1

[19] Select ramp 2

[22]	Run
[23]	Run reverse
[24]	Stop
[26]	DC Brake
[27]	Coast
[28]	Freeze output
[29]	Start timer 0
[30]	Start timer 1
[31]	Start timer 2
[32]	Set digital out A low
[33]	Set digital out B low
[34]	Set digital out C low
[35]	Set digital out D low
[36]	Set digital out E low
[37]	Set digital out F low
[38]	Set digital out A high
[39]	Set digital out B high
[40]	Set digital out C high
[41]	Set digital out D high
[42]	Set digital out E high
[43]	Set digital out F high
[60]	Reset Counter A
[61]	Reset Counter B
[70]	Start Timer 3
[71]	Start Timer 4
[72]	Start Timer 5
[73]	Start Timer 6
[74]	Start Timer 7

**23-02 OFF Time**

Array [10]

Range:	Function:
Application [Application dependant] dependent*	

**23-03 OFF Action**

Array [10]

Option:	Function:
	Select the action during OFF Time. See par. 13-52 <i>SL Controller Action</i> for descriptions of the options.

[0] *	Disabled
[1]	No action
[2]	Select set-up 1
[3]	Select set-up 2
[4]	Select set-up 3

## 2

[5]	Select set-up 4
[10]	Select preset ref 0
[11]	Select preset ref 1
[12]	Select preset ref 2
[13]	Select preset ref 3
[14]	Select preset ref 4
[15]	Select preset ref 5
[16]	Select preset ref 6
[17]	Select preset ref 7
[18]	Select ramp 1
[19]	Select ramp 2
[22]	Run
[23]	Run reverse
[24]	Stop
[26]	DC Brake
[27]	Coast
[28]	Freeze output
[29]	Start timer 0
[30]	Start timer 1
[31]	Start timer 2
[32]	Set digital out A low
[33]	Set digital out B low
[34]	Set digital out C low
[35]	Set digital out D low
[36]	Set digital out E low
[37]	Set digital out F low
[38]	Set digital out A high
[39]	Set digital out B high
[40]	Set digital out C high
[41]	Set digital out D high
[42]	Set digital out E high
[43]	Set digital out F high
[60]	Reset Counter A
[61]	Reset Counter B
[70]	Start Timer 3
[71]	Start Timer 4
[72]	Start Timer 5
[73]	Start Timer 6
[74]	Start Timer 7

**23-04 Occurrence**

Array [10]

**Option:**

**Function:**

Select which day(s) the Timed Action applies to. Specify working/non-working days in par. 0-81 *Working Days*, par. 0-82 *Additional Working Days* and par. 0-83 *Additional Non-Working Days*.

**2**

[0] \* All days

[1] Working days

[2] Non-working days

[3] Monday

[4] Tuesday

[5] Wednesday

[6] Thursday

[7] Friday

[8] Saturday

[9] Sunday

**2.20.2 23-1\* Maintenance**

Wear and tear calls for periodic inspection and service of elements in the application, e.g. motor bearings, feedback sensors and seals or filters. With Preventive Maintenance the service intervals may be programmed into the frequency converter. The frequency converter will give a message when maintenance is required. 20 Preventive Maintenance Events can be programmed into the frequency converter. For each Event the following must be specified:

- Maintenance item (e.g. "Motor Bearings")
- Maintenance action (e.g. "Replace")
- Maintenance Time Base (e.g. "Running Hours" or a specific date and time)
- Maintenance Time Interval or the date and time of next maintenance



**NB!**

To disable a Preventive Maintenance Event the associated par. 23-12 *Maintenance Time Base* must be set to *Disabled*[0].

Preventive Maintenance can be programmed from the LCP, but use of the PC-based VLT Motion Control Tool MCT10 is recommended.

2

ID	Name	Setup 1	Setup 2	Setup 3	Setup 4
2310.0	Maintenance Item	Motor bearings	Motor bearings	Motor bearings	Motor bearings
2310.1	Maintenance Item	Motor bearings	Motor bearings	Motor bearings	Motor bearings
2310.2	Maintenance Item	Motor bearings	Motor bearings	Motor bearings	Motor bearings
2310.3	Maintenance Item	Motor bearings	Motor bearings	Motor bearings	Motor bearings
2310.4	Maintenance Item	Motor bearings	Motor bearings	Motor bearings	Motor bearings
2310.5	Maintenance Item	Motor bearings	Motor bearings	Motor bearings	Motor bearings
2310.6	Maintenance Item	Motor bearings	Motor bearings	Motor bearings	Motor bearings
2310.7	Maintenance Item	Motor bearings	Motor bearings	Motor bearings	Motor bearings
2310.8	Maintenance Item	Motor bearings	Motor bearings	Motor bearings	Motor bearings
2310.9	Maintenance Item	Motor bearings	Motor bearings	Motor bearings	Motor bearings
2310.10	Maintenance Item	Motor bearings	Motor bearings	Motor bearings	Motor bearings
2310.11	Maintenance Item	Motor bearings	Motor bearings	Motor bearings	Motor bearings
2310.12	Maintenance Item	Motor bearings	Motor bearings	Motor bearings	Motor bearings
2310.13	Maintenance Item	Motor bearings	Motor bearings	Motor bearings	Motor bearings
2310.14	Maintenance Item	Motor bearings	Motor bearings	Motor bearings	Motor bearings
2310.15	Maintenance Item	Motor bearings	Motor bearings	Motor bearings	Motor bearings
2310.16	Maintenance Item	Motor bearings	Motor bearings	Motor bearings	Motor bearings
2310.17	Maintenance Item	Motor bearings	Motor bearings	Motor bearings	Motor bearings
2310.18	Maintenance Item	Motor bearings	Motor bearings	Motor bearings	Motor bearings
2310.19	Maintenance Item	Motor bearings	Motor bearings	Motor bearings	Motor bearings
2311.0	Maintenance Action	Lubricate	Lubricate	Lubricates	Lubricate
2311.2	Maintenance Action	Lubricate	Lubricate	Lubricates	Lubricate
2311.3	Maintenance Action	Lubricate	Lubricate	Lubricates	Lubricate
2311.4	Maintenance Action	Lubricate	Lubricate	Lubricates	Lubricate
2311.5	Maintenance Action	Lubricate	Lubricate	Lubricates	Lubricate
2311.6	Maintenance Action	Lubricate	Lubricate	Lubricates	Lubricate

The LCP indicates (with a wrench-icon and an "M") when it is time for a Preventive Maintenance Action, and can be programmed to be indicated on a digital output in parameter group 5-3\*. The Preventive Maintenance Status may be read in par. 16-96 *Maintenance Word*. A Preventive Maintenance indication can be reset from a digital input, the FC bus or manually from the LCP through par. 23-15 *Reset Maintenance Word*.

A Maintenance Log with the latest 10 loggings can be read from parameter group 18-0\* and via the Alarm log button on the LCP after selecting Maintenance Log.

**23-10 Maintenance Item**

**Option:**

**Function:**

Select the item to be associated with the Preventive Maintenance Event.

- [1] \* Motor bearings
- [2] Fan bearings
- [3] Pump bearings
- [4] Valve
- [5] Pressure transmitter
- [6] Flow transmitter
- [7] Temperature transm.
- [8] Pump seals
- [9] Fan belt
- [10] Filter
- [11] Drive cooling fan
- [12] System health check
- [13] Warranty



**NB!**

The Preventive Maintenance Events are defined in a 20 element array. Hence each Preventive Maintenance Event must use the same array element index in par. 23-10 *Maintenance Item* to par. 23-14 *Maintenance Date and Time*.

**2**

**23-11 Maintenance Action**

Option:	Function:
	Select the action to be associated with the Preventive Maintenance Event.
[1] * Lubricate	
[2] Clean	
[3] Replace	
[4] Inspect/Check	
[5] Overhaul	
[6] Renew	
[7] Check	
[20] Maintenance Text 0	
[21] Maintenance Text 1	
[22] Maintenance Text 2	
[23] Maintenance Text 3	
[24] Maintenance Text 4	
[25] Maintenance Text 5	

**23-12 Maintenance Time Base**

Option:	Function:
	Select the time base to be associated with the Preventive Maintenance Event.
[0] * Disabled	<i>Disabled</i> [0] must be used when disabling the Preventive Maintenance Event.
[1] Running Hours	<i>Running Hours</i> [1] is the number of hours the motor has been running. Running hours are not reset at power-on. The <i>Maintenance Time Interval</i> must be specified in par. 23-13 <i>Maintenance Time Interval</i> .
[2] Operating Hours	<i>Operating Hours</i> [2] is the number of hours the frequency converter has been running. Operating hours are not reset at power-on. The <i>Maintenance Time Interval</i> must be specified in par. 23-13 <i>Maintenance Time Interval</i> .
[3] Date & Time	<i>Date &amp; Time</i> [3] uses the internal clock. The date and time of the next maintenance occurrence must be specified in par. 23-14 <i>Maintenance Date and Time</i> .

**23-13 Maintenance Time Interval**

Range:	Function:
1 h* [1 - 2147483647 h]	Set the interval associated with the current Preventive Maintenance Event. This parameter is only used if <i>Running Hours</i> [1] or <i>Operating Hours</i> [2] is selected in par. 23-12 <i>Maintenance Time Base</i> . The timer is reset from par. 23-15 <i>Reset Maintenance Word</i> .
	<b>Example:</b> A Preventive Maintenance Event is set up Monday at 8:00. par. 23-12 <i>Maintenance Time Base</i> is <i>Operating hours</i> [2] and par. 23-13 <i>Maintenance Time Interval</i> is 7 x 24 hours=168 hours. Next Maintenance Event will be indicated the following Monday at 8:00. If this Maintenance Event is not reset until Tuesday at 9:00, the next occurrence will be the following Tuesday at 9:00.

## 2

**23-14 Maintenance Date and Time****Range:**Application [Application dependant]  
dependent\***Function:****23-15 Reset Maintenance Word****Option:****Function:**Set this parameter to *Do reset* [1] to reset the Maintenance Word in par. 16-96 *Maintenance Word* and reset the message displayed in the LCP. This parameter will change back to *Do not reset* [0] when pressing OK.

[0] \* Do not reset

[1] Do reset

**NB!**When messages are reset - Maintenance Item, Action and Maintenance Date/Time are not cancelled. par. 23-12 *Maintenance Time Base* is set to Disabled [0].**2.20.3 23-5\* Energy Log**

The frequency converter is continuously accumulating the consumption of the motor controlled, based on the actual power yielded by the frequency converter.

These data can be used for an Energy Log function allowing the user to compare and structure the information about the energy consumption related to time.

There are basically two functions:

- Data related to a pre-programmed period, defined by a set date and time for start
- Data related to a predefined period back in time e.g. last seven days within the pre-programmed period

For each of the above two functions, the data are stored in a number of counters allowing for selecting time frame and a split on hours, days or weeks. The period/split (resolution) can be set in par. 23-50 *Energy Log Resolution*.

The data are based on the value registered by the kWh counter in the frequency converter. This counter value can be read in par. 15-02 *kWh Counter* containing the accumulated value since the first power up or latest reset of the counter (par. 15-06 *Reset kWh Counter*).

All data for the Energy Log are stored in counters which can be read from par. 23-53 *Energy Log*.

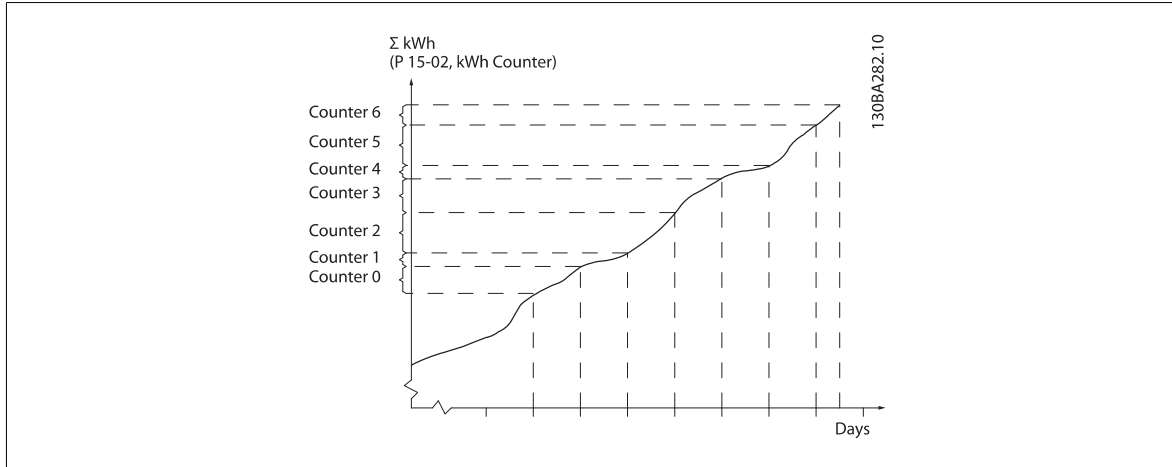

Counter 00 will always contain the oldest data. A counter will cover a period from XX:00 to XX:59 if hours or 00:00 to 23:59 if days.  
If logging either the last hours or last days, the counters will shift contents at XX:00 every hour or at 00:00 every day.  
Counter with highest index will always be subject to update (containing data for the actual hour since XX:00 or the actual day since 00:00).

The contents of counters can be displayed as bars on LCP. Select *Quick Menu, Loggings, Energy Log: Trending Continued Bin / Trending Timed Bin / Trending Comparison*.

### 23-50 Energy Log Resolution

**Option:**

**Function:**

Select the desired type of period for logging of consumption. Hour of Day [0] , Day of Week [1] or Day of Month [2]. The counters contain the logging data from the programmed date/time for start (par. 23-51 *Period Start*) and the numbers of hours/days as programmed for (par. 23-50 *Energy Log Resolution*).

The logging will start on the date programmed in par. 23-51 *Period Start*, and continue until one day/week/month has gone. Last 24 Hours [5], Last 7 Days [6] or Last 5 Weeks [7]. The counters contain data for one day, one week or five weeks back in time and up to the actual time.

The logging will start at the date programmed in par. 23-51 *Period Start*. In all cases the period split will refer to Operating Hours (time where frequency converter is powered up).

- [0] Hour of Day
- [1] Day of Week
- [2] Day of Month
- [5] \* Last 24 Hours
- [6] Last 7 Days
- [7] Last 5 Weeks



**NB!**

The frequency converter has no back up of the clock function and the set date/time will reset to default (2000-01-01 00:00) after a power down unless a Real Time Clock module with back up is installed. Consequently the logging will be stopped until date/time is readjusted in par. 0-70 *Date and Time*. In par. 0-79 *Clock Fault* it is possible to program for a Warning in case clock not has been set properly, e.g. after a power down.





**NB!**

When mounting an Analog I/O MCB109 option card, a battery back up of the date and time is included.

**2**

**23-54 Reset Energy Log**

**Option:**

**Function:**

Select *Do reset* [1] to reset all values in the Energy Log counters shown in par. 23-53 *Energy Log*. After pressing OK the setting of the parameter value will automatically change to *Do not reset* [0].

[0] \* Do not reset

[1] Do reset

**2.20.4 23-6\* Trending**

Trending is used to monitor a process variable over a period of time and record how often the data falls into each of ten user-defined data ranges. This is a convenient tool to get a quick overview indicating where to put focus for improvement of operation.

Two sets of data for Trending can be created in order to make it possible to compare current values for a selected operating variable with data for a certain reference period, for the same variable. This reference period can be pre-programmed (par. 23-63 *Timed Period Start* and par. 23-64 *Timed Period Stop*). The two sets of data can be read from par. 23-61 *Continuous Bin Data* (current) and par. 23-62 *Timed Bin Data* (reference).

It is possible to create Trending for following operation variables:

- Power
- Current
- Output frequency
- Motor Speed

The Trending function includes ten counters (forming a bin) for each set of data containing the numbers of registrations reflecting how often the operating variable is within each of ten pre-defined intervals. The sorting is based on a relative value of the variable.

The relative value for the operating variable is

Actual/Rated \* 100%.

for Power and Current and

Actual/Max \* 100%

for Output Frequency and Motor Speed.

The size of each interval can be adjusted individually, but will default be 10% for each. Power and Current can exceed rated value, but those registrations will be included in 90%-100% (MAX) counter.

2

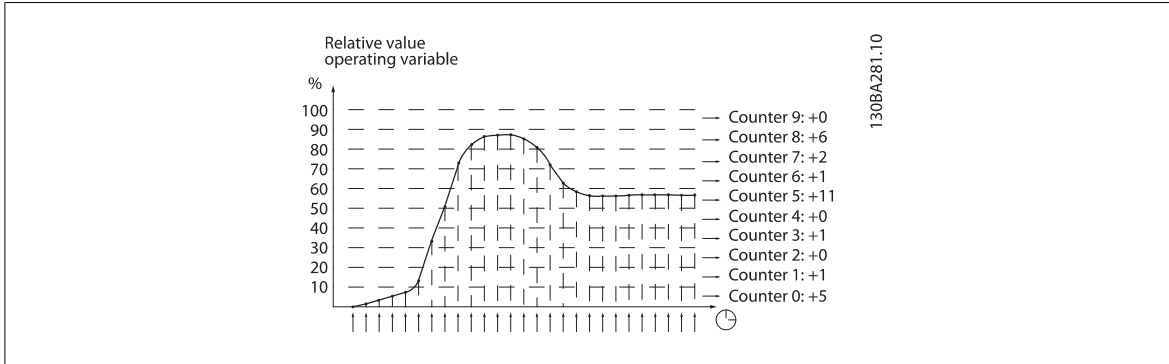

Once a second, the value of the operating variable selected is registered. If a value has been registered to equal 13%, the counter "10% - <20%" will be updated with the value "1". If the value stays at 13% for 10s, then "10" will be added to the counter value.

The contents of counters can be displayed as bars on LCP. Select *Quick Menu > Loggings: Trending Continued Bin / Trending Timed Bin / Trending Comparison*.

**NB!**  
The counters starts counting whenever the frequency converter is powered-up. Power cycle shortly after a reset will zero the counters. EEPROM data are updated once per hour.

**23-60 Trend Variable**

Option:	Function:
	Select the desired operating variable to be monitored for Trending.
[0] *    Power [kW]	Power yielded to the motor. Reference for the relative value is the rated motor power programmed in par. 1-20 <i>Motor Power [kW]</i> or par. 1-21 <i>Motor Power [HP]</i> . Actual value can be read in par. 16-10 <i>Power [kW]</i> or par. 16-11 <i>Power [hp]</i> .
[1]        Current [A]	Output current to the motor. Reference for the relative value is the rated motor current programmed in par. 1-24 <i>Motor Current</i> . Actual value can be read in par. 16-14 <i>Motor Current</i> .
[2]        Frequency [Hz]	Output frequency to the motor. Reference for the relative value is the maximum output frequency programmed in par. 4-14 <i>Motor Speed High Limit [Hz]</i> . Actual value can be read in par. 16-13 <i>Frequency</i> .
[3]        Motor Speed [RPM]	Speed of the motor. Reference for relative value is the maximum motor speed programmed in par. 4-13 <i>Motor Speed High Limit [RPM]</i> .

**23-61 Continuous Bin Data**

Range:	Function:
0* [0 - 4294967295 ]	<p>Array with 10 elements ([0]-[9] below parameter number in display). Press OK and step between elements by means of ▲ and ▼ buttons on the LCP.</p> <p>10 counters with the frequency of occurrence for the operating variable monitored, sorted according to the following intervals:</p> <ul style="list-style-type: none"> <li>Counter [0]: 0% - &lt;10%</li> <li>Counter [1]: 10% - &lt;20%</li> <li>Counter [2]: 20% - &lt;30%</li> <li>Counter [3]: 30% - &lt;40%</li> <li>Counter [4]: 40% - &lt;50%</li> <li>Counter [5]: 50% - &lt;60%</li> <li>Counter [6]: 60% - &lt;70%</li> <li>Counter [7]: 70% - &lt;80%</li> <li>Counter [8]: 80% - &lt;90%</li> <li>Counter [9]: 90% - &lt;100% or Max</li> </ul> <p>The above minimum limits for the intervals are the default limits. These can be changed in par. 23-65 <i>Minimum Bin Value</i>.</p> <p>Starts to count when the frequency converter is powered up for the first time. All counters can be reset to 0 in par. 23-66 <i>Reset Continuous Bin Data</i>.</p>

**23-62 Timed Bin Data**

Range:	Function:
0* [0 - 4294967295 ]	<p>Array with 10 elements ([0]-[9] below parameter number in display). Press OK and step between elements by means of ▲ and ▼ buttons on the LCP.</p> <p>10 counters with the frequency of occurrence for the operating data monitored sorted according to the intervals as for par. 23-61 <i>Continuous Bin Data</i>.</p> <p>Starts to count at the date/time programmed in par. 23-63 <i>Timed Period Start</i>, and stops at the time/date programmed in par. 23-64 <i>Timed Period Stop</i>. All counters can be reset to 0 in par. 23-67 <i>Reset Timed Bin Data</i>.</p>

**23-63 Timed Period Start**

Range:	Function:
Application dependent* [Application dependant]	

 **NB!**  
The frequency converter has no back up of the clock function and the set date/time will reset to default (2000-01-01 00:00) after a power down unless a Real Time Clock module with back up is installed. Consequently the logging will be stopped until date/time is readjusted in par. 0-70 *Date and Time*. In par. 0-79 *Clock Fault* it is possible to program for a Warning in case clock not has been set properly, e.g. after a power down.

 **NB!**  
When mounting an Analog I/O MCB109 option card, a battery back up of the date and time is included.



As value for the fixed speed case, the rated motor size (kW) is multiplied with a factor (set in %) representing the power yielded at fixed speed. The difference between this reference power and the actual power is accumulated and stored. The difference in energy can be read in par. 23-83, *Energy Savings*.

The accumulated value for the difference in power consumption is multiplied with the energy cost in local currency and the investment is subtracted. This calculation for Cost Savings can also be read in par. 23-84, *Cost Savings*.

$$\text{Cost Savings} = (\Sigma(\text{Reference Power} - \text{Actual Power})) * \text{Energy Cost} - \text{Additional Cost}$$

Break even (payback) occurs when the value read in the parameter turns from negative to positive.

It is not possible to reset the Energy Savings counter, but the counter can be stopped any time by setting par. 23-80, *Power Reference Factor*, to 0.

Parameter overview:

Parameter for settings		Parameters for readout	
Rated Motor Power	Par. 1-20	Energy Savings	Par. 23-83
Power Reference Factor in %	Par. 23-80	Actual Power	Par. 16-10/11
Energy Cost per kWh	Par. 23-81	Cost Savings	Par. 23-84
Investment	Par. 23-82		

**23-80 Power Reference Factor**

**Range:**

100 %\* [0 - 100 %]

**Function:**

Set the percentage of the rated motor size (set in par. 1-20 *Motor Power [kW]* or par. 1-21 *Motor Power [HP]*) which is supposed to represent the average power yielded at the time running with fixed speed (before upgrade with variable speed control).

Must be set to a value different from zero to start counting.

**23-81 Energy Cost**

**Range:**

1.00\* [0.00 - 999999.99 ]

**Function:**

Set the actual cost for a kWh in local currency. If the energy cost is changed later on it will impact the calculation for the entire period!

**23-82 Investment**

**Range:**

0\* [0 - 999999999 ]

**Function:**

Set the value of the investment spent on upgrading the plant with speed control, in same currency as used in par. 23-81 *Energy Cost*.

**23-83 Energy Savings**

**Range:**

0 kWh\* [0 - 0 kWh]

**Function:**

This parameter allows a readout of the accumulated difference between the reference power and the actual output power.

If motor size set in Hp (par. 1-21 *Motor Power [HP]*), the equivalent kW value will be used for the Energy Savings.

**23-84 Cost Savings**

**Range:**

0\* [0 - 2147483647 ]

**Function:**

This parameter allows a readout of the calculation based on the above equation (in local currency).

## 2.20 Main Menu - Cascade Controller - Group 25

### 2.21.1 25-\*\* Cascade Controller

# 2

Parameters for configuring the Basic Cascade Controller for sequence control of multiple pumps. For a more application oriented description and wiring examples, see section *Application Examples, Basic Cascade Controller*.

To configure the Cascade Controller to the actual system and the desired control strategy, it is recommended to follow the below sequence, starting with par. 25-0\* *System Settings* and next par. 25-5\* *Alternation Settings*. These parameter can normally be set in advance.

Parameters in 25-2\* *Bandwidth Settings* and 25-4\* *Staging settings*, will often be dependent on the dynamic of the system and final adjustment to be done at the commissioning of the plant.

**NB!** The Cascade Controller is supposed to operate in closed loop controlled by the built-in PI controller (Closed Loop selected in *Configuration Mode*, par. 1-00 *Configuration Mode*). If *Open Loop* is selected in par. 1-00 *Configuration Mode*, all fixed speed pumps will be destaged, but the variable speed pump will still be controlled by the frequency converter, now as an open loop configuration:

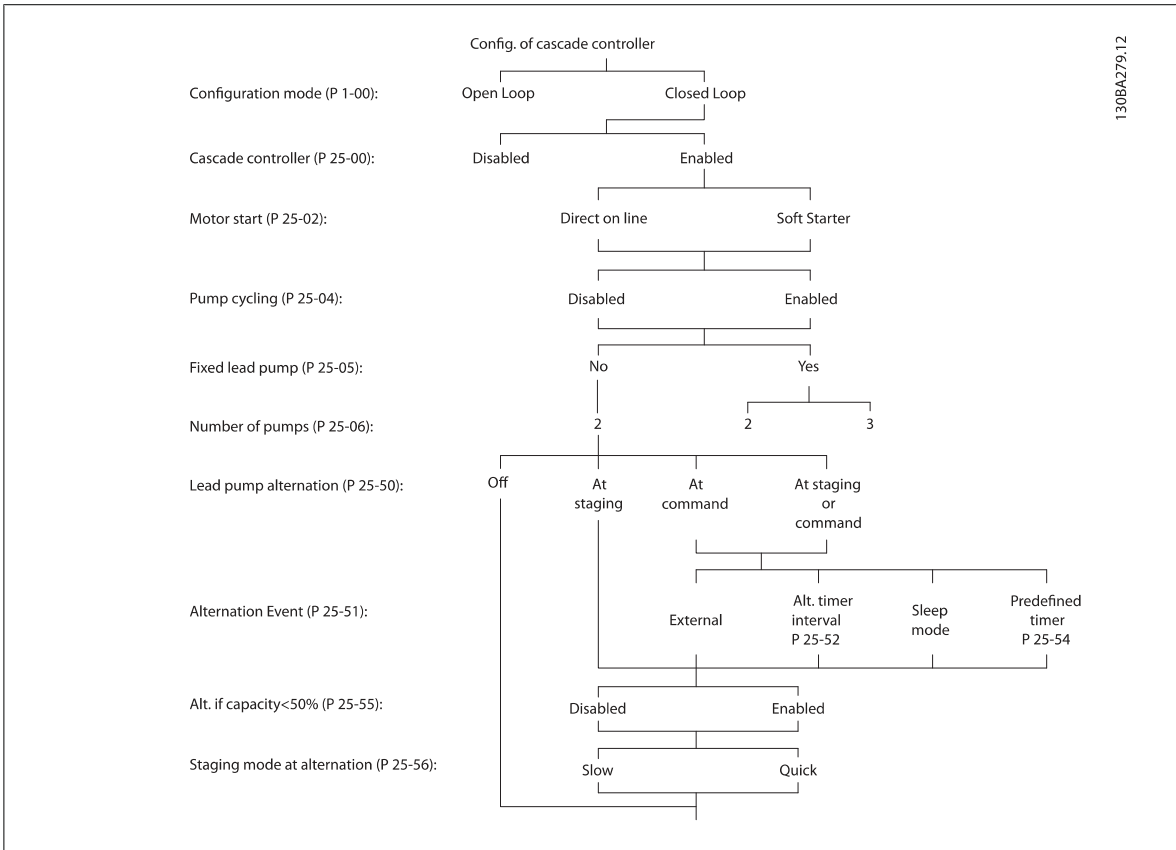

### 2.21.2 25-0\* System Settings

Parameters related to control principles and configuration of the system.

25-00 Cascade Controller	
Option:	Function:
	For operation of multiple devices (pump/fan) systems where capacity is adapted to actual load by means of speed control combined with on/off control of the devices. For simplicity only pump systems are described.
[0] * Disabled	The Cascade Controller is not active. All built-in relays assigned to pump motors in the cascade function will be de-energized. If a variable speed pump is connected to the frequency converter directly (not controlled by a built-in relay); this pump/fan will be controlled as a single pump system.
[1] Basic Cascade Ctrl	The Cascade Controller is active and will stage/destage pumps according to load on the system.
[2] * Motor Alternation Only	
25-02 Motor Start	
Option:	Function:
	Motors are connected to the mains directly with a contactor or with a soft starter. When the value of par. 25-02 <i>Motor Start</i> is set to an option other than <i>Direct on Line</i> [0], then par. 25-50 <i>Lead Pump Alternation</i> is automatically set to the default of <i>Direct on Line</i> [0].
[0] * Direct on Line	Each fixed speed pump is connected to line directly via a contactor.
[1] Soft Starter	Each fixed speed pump is connected to line via a soft starter.
[2] Star Delta	
25-04 Pump Cycling	
Option:	Function:
	To provide equal hours of operation with fixed speed pumps, the pump use can be cycled. The selection of pump cycling is either "first in – last out" or equal running hours for each pump.
[0] * Disabled	The fixed speed pumps will be connected in the order 1 – 2 and disconnected in the order 2 – 1. (First in – last out).
[1] Enabled	The fixed speed pumps will be connected/disconnected to have equal running hours for each pump.
25-05 Fixed Lead Pump	
Option:	Function:
	Fixed Lead Pump means that the variable speed pump is connected directly to the frequency converter and if a contactor is applied between frequency converter and pump, this contactor will not be controlled by the frequency converter. If operating with par. 25-50 <i>Lead Pump Alternation</i> set to other than <i>Off</i> [0], this parameter must be set to <i>No</i> [0].
[0] No	The lead pump function can alternate between the pumps controlled by the two built in relays. One pump must be connected to the built-in RELAY 1, and the other pump to RELAY 2. The pump function (Cascade Pump1 and Cascade Pump2) will automatically be assigned to the relays (maximum two pumps can in this case be controlled from the frequency converter).
[1] * Yes	The lead pump will be fixed (no alternation) and connected directly to the frequency converter. The par. 25-50 <i>Lead Pump Alternation</i> is automatically set to <i>Off</i> [0]. Built-in relays Relay 1 and Relay 2 can be assigned to separate fixed speed pumps. In total three pumps can be controlled by the frequency converter.

2

**25-06 Number of Pumps**

**Range:**

2\* [Application dependant]

**Function:**

The number of pumps connected to the Cascade Controller including the variable speed pump. If the variable speed pump is connected directly to the frequency converter and the other fixed speed pumps (lag pumps) are controlled by the two built in relays, three pumps can be controlled. If both the variable speed and fixed speed pumps are to be controlled by built-in relays, only two pumps can be connected.

If *par. 25-05 Fixed Lead Pump, Fixed Lead Pump*, is set to *No [0]*: one variable speed pump and one fixed speed pump; both controlled by built in relay. If *par. 25-05 Fixed Lead Pump, Fixed Lead Pump*, is set to *Yes [1]*: one variable speed pump and one fixed speed pump controlled by built-in relay.

One lead pump, see *par. 25-05 Fixed Lead Pump*. Two fixed speed pumps controlled by built-in relays.

**2.21.3 25-2\* Bandwidth Settings**

Parameters for setting the bandwidth within which the pressure will be allowed to operate before staging/destaging fixed speed pumps. Also includes various timers to stabilize the control.

**25-20 Staging Bandwidth**

**Range:**

Application dependent\* [Application dependant]

**Function:**

**25-21 Override Bandwidth**

**Range:**

100 %\* [Application dependant]

**Function:**

When a large and quick change in the system demand occurs (such as a sudden water demand), the system pressure rapidly changes and an immediate staging or destaging of a fixed speed pump becomes necessary to match the requirement. The override bandwidth (OBW) is programmed to override the staging/destaging timer (*par. 25-23 SBW Staging Delay* and *par. 25-24 SBW Destaging Delay*) for immediate response.

The OBW must always be programmed to a higher value than the value set in *Staging Bandwidth* (SBW), *par. 25-20 Staging Bandwidth*. The OBW is a percentage of *par. 175ZA673.10* and *par. 175ZA673.10*.

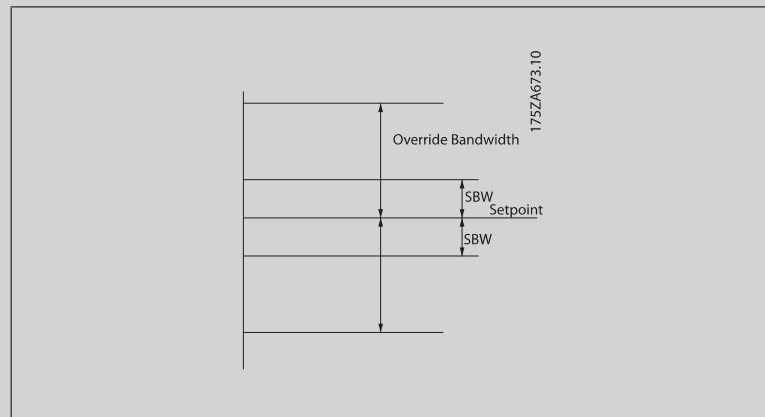

Setting the OBW too close to the SBW could defeat the purpose with frequent staging at momentary pressure changes. Setting the OBW too high might lead to unacceptably high or low pressure in the

system while the SBW timers are running. The value can be optimized with increased familiarity with the system. See par. 25-25 *OBW Time*.

To avoid unintended staging during the commissioning phase and fine tuning of the controller, initially leave the OBW at the factory setting of 100% (Off). When the fine tuning is completed, the OBW should be set to the desired value. An initial value of 10% is suggested.

**25-22 Fixed Speed Bandwidth**

**Range:**

Application [Application dependant]  
dependent\*

**Function:**

**25-23 SBW Staging Delay**

**Range:**

15 s\* [0 - 3000 s]

**Function:**

Immediate staging of a fixed speed pump is not desirable when a momentary pressure drop in the system exceeds the Staging Bandwidth (SBW). Staging is delayed by the length of time programmed. If the pressure increases to within the SBW before the timer has elapsed, the timer is reset.

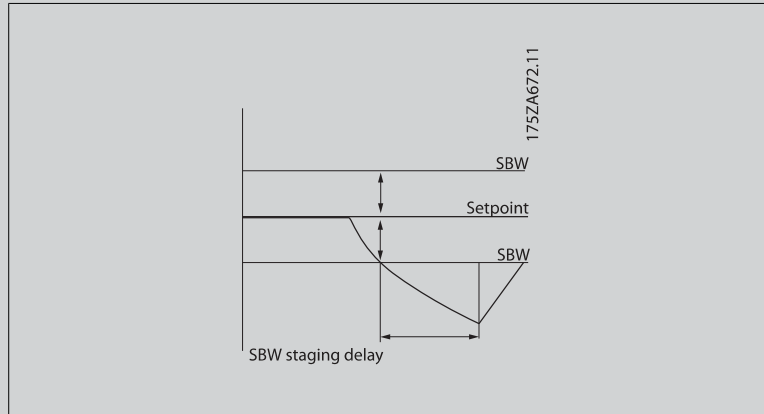

**25-24 SBW Destaging Delay**

**Range:**

15 s\* [0 - 3000 s]

**Function:**

Immediate destaging of a fixed speed pump is not desirable when a momentary pressure increase in the system that exceeds the Staging Bandwidth (SBW). Destaging is delayed by the length of time programmed. If the pressure decreases to within the SBW before the timer has elapsed, the timer is reset.

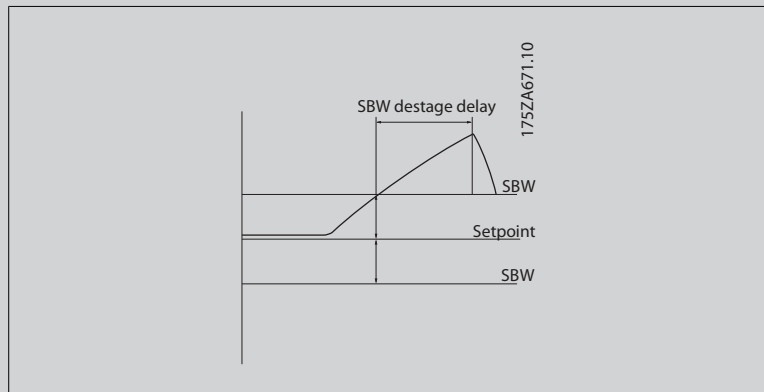

**25-25 OBW Time****Range:**

10 s\* [0 - 300 s]

**Function:**

Staging a fixed speed pump creates a momentary pressure peak in the system, which might exceed the Override Bandwidth (OBW). It is not desirable to destage a pump in response to a staging pressure peak. The OBW Time can be programmed to prevent staging until the system pressure has stabilized and normal control established. Set the timer to a value that allows the system to stabilize after staging. The 10 second factory setting is appropriate in most applications. In highly dynamic systems, a shorter time may be desirable.

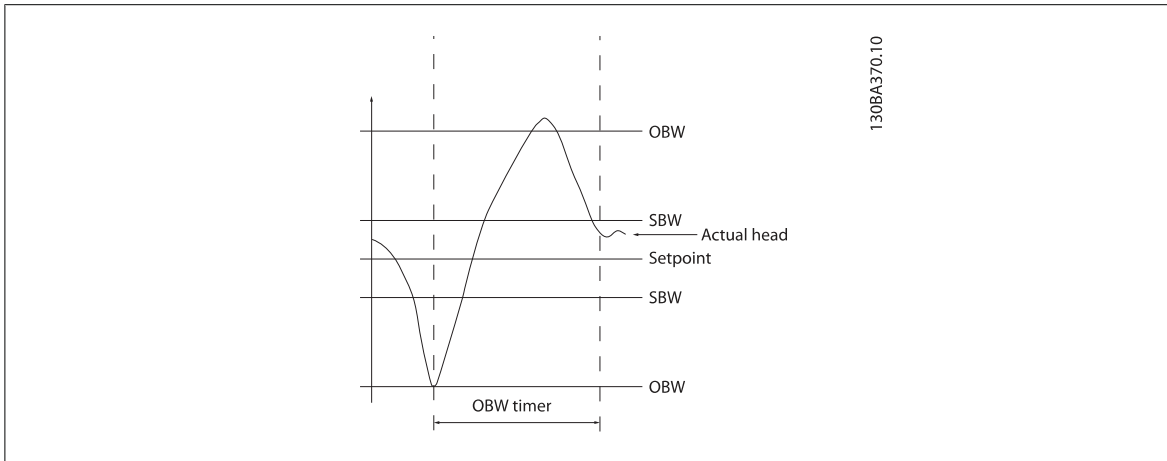
**25-26 Destage At No-Flow****Option:**

[0] \* Disabled  
[1] Enabled

**Function:**

The Destage at No-Flow parameter ensures that when a no-flow situation occurs, the fixed speed pumps will be destaged one-by-one until the no-flow signal disappears. This requires that No Flow Detection is active. See par. 22-2\*.  
If Destage at No-Flow is disabled the Cascade Controller does not change the normal behavior of the system.

**25-27 Stage Function****Option:**

[0] Disabled  
[1] \* Enabled

**Function:**

If the Stage Function is set to *Disabled* [0], par. 25-28 *Stage Function Time* will not be activated.

**25-28 Stage Function Time****Range:**

15 s\* [0 - 300 s]

**Function:**

The Stage Function Time is programmed to avoid frequent staging of the fixed speed pumps. The Stage Function Time starts if it is *Enabled* [1] by par. 25-27 *Stage Function*, and when the variable speed pump is running at *Motor Speed High Limit*, par. 4-13 *Motor Speed High Limit [RPM]* or par. 4-14 *Motor Speed High Limit [Hz]*, with at least one fixed speed pump in the stop position. When the programmed value of the timer expires, a fixed speed pump is staged.

**25-29 Destage Function**

**Option:**

**Function:**

The Destage Function ensures that the lowest numbers of pumps are running to save energy and to avoid dead head water circulation in the variable speed pump. If the Destage Function is set to *Disabled* [0], the par. 25-30 *Destage Function Time* will not be activated.

[0] Disabled

[1] \* Enabled

**25-30 Destage Function Time**

**Range:**

**Function:**

15 s\* [0 - 300 s]

The Destage Function Timer is programmable to avoid frequent staging/destaging of the fixed speed pumps. The Destage Function Time starts when the adjustable speed pump is running at par. 4-11 *Motor Speed Low Limit [RPM]* or par. 4-12 *Motor Speed Low Limit [Hz]*, with one or more fixed speed pumps in operation and system requirements satisfied. In this situation, the adjustable speed pump contributes a little to the system. When the programmed value of the timer expires, a stage is removed, avoiding dead head water circulation in the adjustable speed pump.

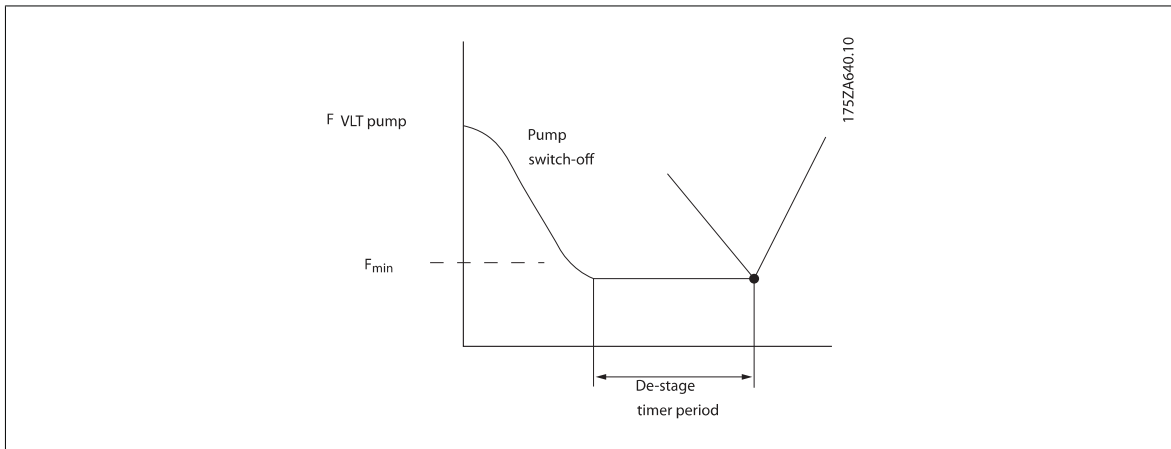

2

2.21.4 25-4\* Staging Settings

Parameters determining conditions for staging/destaging the pumps.

25-40 Ramp Down Delay

Range:	Function:
10.0 s* [0.0 - 120.0 s]	When adding a fixed speed pump controlled by a soft starter, it is possible to delay the ramp down of the lead pump until a preset time after the start of the fixed speed pump to eliminate pressure surges or water hammer in the system.  Only to be used if <i>Soft Starter</i> [1] is selected in par. 25-02 <i>Motor Start</i> .

25-41 Ramp Up Delay

Range:	Function:
2.0 s* [0.0 - 12.0 s]	When removing a fixed speed pump controlled by a soft starter, it is possible to delay the ramp up of the lead pump until a preset time after the stopping of the fixed speed pump to eliminate pressure surges or water hammer in the system.  Only to be used if <i>Soft Starter</i> [1] is selected in par. 25-02 <i>Motor Start</i> .

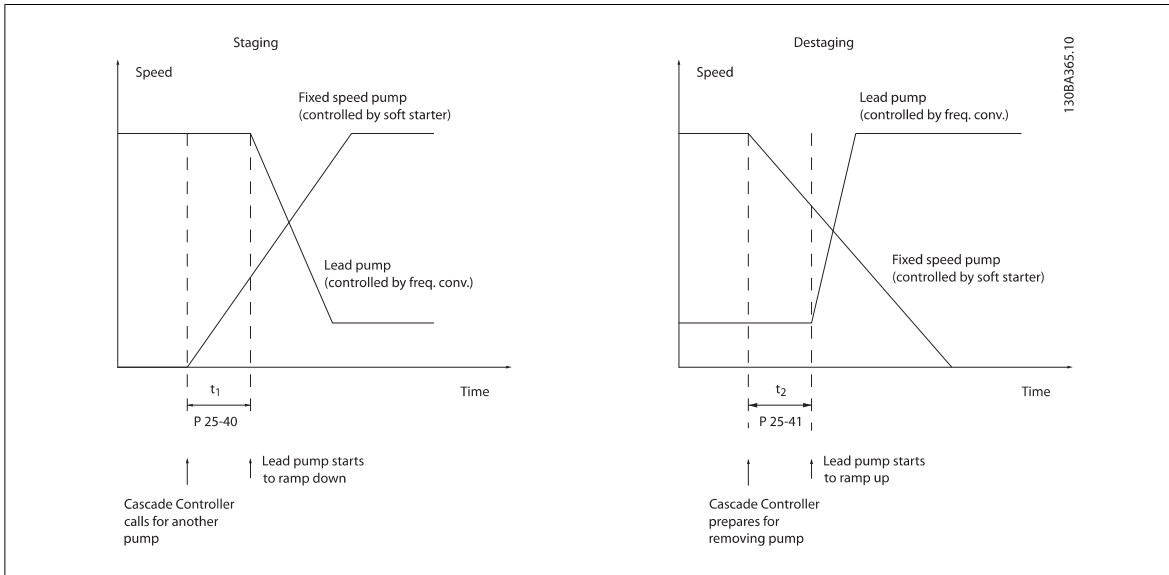

25-42 Staging Threshold

Range:	Function:
Application [Application dependant] dependent*	

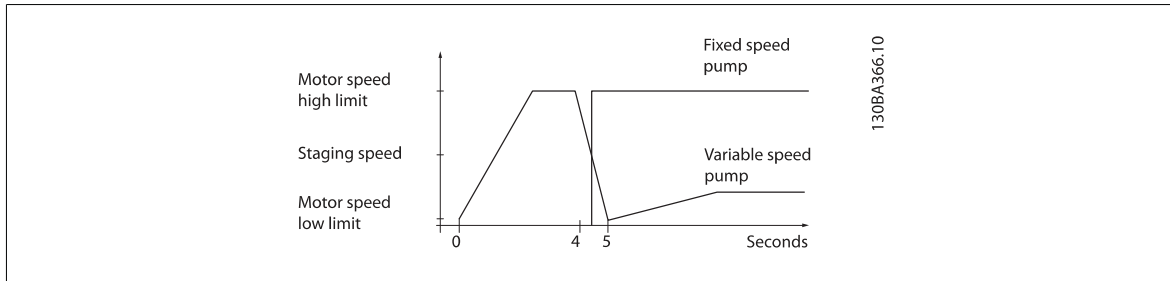

**NB!**  
If the set-point is reached after staging before the variable speed pump reaches its minimum speed - the system will enter the state closed loop as soon as the feedback pressure is crossing the set-point.

**25-43 Destaging Threshold**

**Range:** Application [Application dependant] dependent\*  
**Function:**

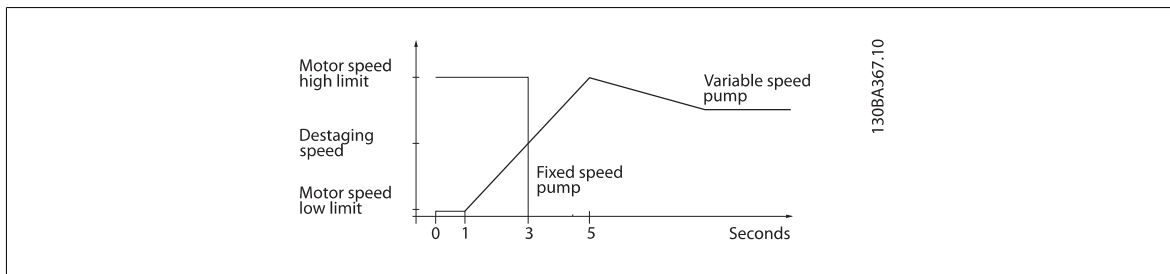

**NB!**  
If the set-point is reached after staging before the variable speed pump reaches its maximum speed - the system will enter the state closed loop as soon as the feedback pressure is crossing the set-point.

**25-44 Staging Speed [RPM]**

**Range:** 0 RPM\* [0 - 0 RPM]  
**Function:** Readout of the below calculated value for Staging Speed When adding a fixed speed pump, in order to prevent an overshoot of pressure, the variable speed pump ramps down to a lower speed. When the variable speed pump reaches the "Staging Speed" the fixed speed pump is staged on. Staging Speed calculation is based on par. 25-42 *Staging Threshold*, and par. 4-13 *Motor Speed High Limit [RPM]*.

Staging Speed is calculated with the following formula:

$$STAGE = \frac{HIGH \cdot n_{STAGE100\%}}{100}$$

where n<sub>HIGH</sub> is Motor Speed High Limit and n<sub>STAGE100%</sub> is the value of Staging Threshold.

**25-45 Staging Speed [Hz]****Range:**

0.0 Hz\* [0.0 - 0.0 Hz]

**Function:**

Readout of the below calculated value for Staging Speed. When adding a fixed speed pump, in order to prevent an overshoot of pressure, the variable speed pump ramps down to a lower speed. When the variable speed pump reaches the "Staging Speed" the fixed speed pump is staged on. Staging Speed calculation is based on par. 25-42 *Staging Threshold*, and par. 4-14 *Motor Speed High Limit [Hz]*.

Staging Speed is calculated with the following formula:

$$STAGE = HIGH \frac{STAGE\%}{100}$$

where  $n_{HIGH}$  is Motor Speed High Limit and  $n_{STAGE100\%}$  is the value of Staging Threshold.

**25-46 Destaging Speed [RPM]****Range:**

0 RPM\* [0 - 0 RPM]

**Function:**

Readout of the below calculated value for Destaging Speed. When removing a fixed speed pump, in order to prevent an undershoot of pressure, the variable speed pump ramps up to a higher speed. When the variable speed pump reaches the "Destaging Speed" the fixed speed pump is destaged. Destaging Speed is calculated based on par. 25-43 *Destaging Threshold*, and par. 4-13 *Motor Speed High Limit [RPM]*.

Destaging Speed is calculated with the following formula:

$$DESTAGE = HIGH \frac{DESTAGE\%}{100}$$

where  $n_{HIGH}$  is Motor Speed High Limit and  $n_{DESTAGE100\%}$  is the value of Destaging Threshold.

**25-47 Destaging Speed [Hz]****Range:**

0.0 Hz\* [0.0 - 0.0 Hz]

**Function:**

Readout of the below calculated value for Destaging Speed. When removing a fixed speed pump, in order to prevent an undershoot of pressure, the variable speed pump ramps up to a higher speed. When the variable speed pump reaches the "Destaging Speed" the fixed speed pump is destaged. Destaging Speed is calculated based on par. 25-43 *Destaging Threshold*, and par. 4-14 *Motor Speed High Limit [Hz]*.

Destaging Speed is calculated with the following formula:

$$DESTAGE = HIGH \frac{DESTAGE\%}{100}$$

where  $n_{HIGH}$  is Motor Speed High Limit and  $n_{DESTAGE100\%}$  is the value of Destaging Threshold.

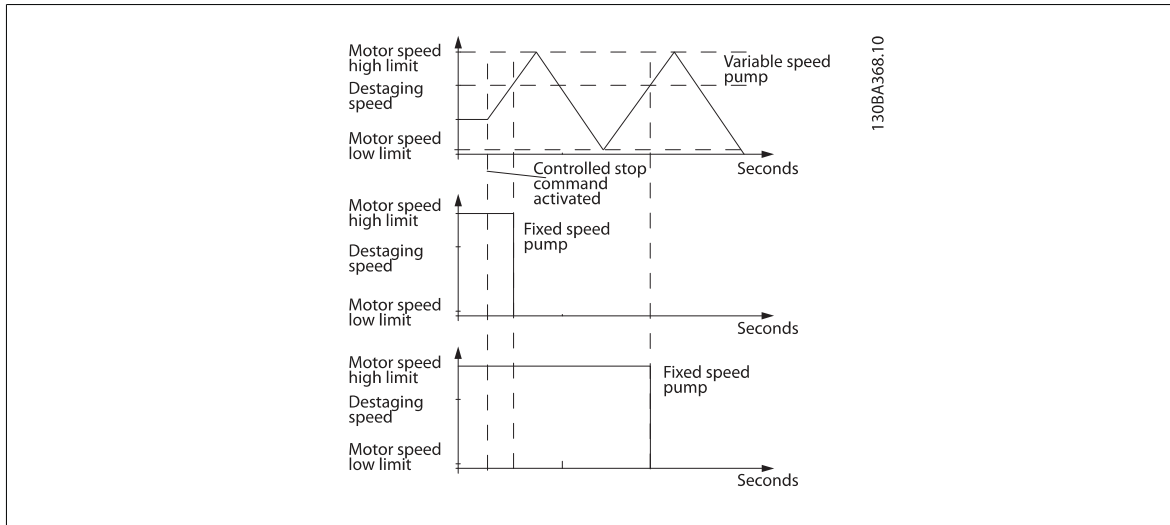

### 2.21.5 25-5\* Alternation Settings

Parameters for defining the conditions for alternation of the variable speed pump (lead), if selected as part of the control strategy.

#### 25-50 Lead Pump Alternation

**Option:**

**Function:**

Lead pump alternation equalizes the use of pumps by periodically changing the pump that is speed controlled. This ensures that pumps are equally used over time. Alternation equalizes the usage of pumps by always choosing the pump with the lowest number of used hours to stage on next.

[0] *	Off	No alternation of lead pump function will take place. It is not possible to set this parameter to options other than <i>Off</i> [0] if par. 25-02 <i>Motor Start</i> is set other than <i>Direct on Line</i> [0].
[1]	At staging	Alternation of the lead pump function will take place when staging another pump.
[2]	At command	Alternation of the lead pump function will take place at an external command signal or a pre-programmed event. See par. 25-51 <i>Alternation Event</i> for available options.
[3]	At staging or command	Alternation of the variable speed (lead) pump will take place at staging or the "At Command" signal. (See above.)



**NB!**

It is not possible to select other than *Off*[0] if par. 25-05 *Fixed Lead Pump* is set to *Yes* [1].

**25-51 Alternation Event****Option:****Function:**

This parameter is only active if the options *At Command* [2] or *At Staging or Command* [3] have been selected in par. 25-50 *Lead Pump Alternation*. If an Alternation Event is selected, the alternation of lead pump takes place every time the event occurs.

[0] *	External	Alternation takes place when a signal is applied to one of the digital inputs on the terminal strip and this input has been assigned to <i>Lead Pump Alternation</i> [121] in par. 5-1*, <i>Digital Inputs</i> .
[1]	Alternation Time Interval	Alternation takes place every time par. 25-52 <i>Alternation Time Interval</i> , expires.
[2]	Sleep Mode	Alternation takes place each time the lead pump goes into sleep mode. par. 20-23 <i>Setpoint 3</i> must be set to <i>Sleep Mode</i> [1] or an external signal applied for this function.
[3]	Predefined Time	Alternation takes place at a defined time of the day. If par. 25-54 <i>Alternation Predefined Time</i> , is set, the alternation is carried out every day at the specified time. Default time is midnight (00:00 or 12:00AM depending on the time format).

**25-52 Alternation Time Interval****Range:****Function:**

24 h\* [0 - 999 h]

If *Alternation Time Interval* [1] option in par. 25-51 *Alternation Event*, is selected, the alternation of the variable speed pump takes place every time the Alternation Time Interval expires (can be checked out in par. 25-53 *Alternation Timer Value*).

**25-53 Alternation Timer Value****Range:****Function:**

0\* [0 - 0]

Readout parameter for the Alternation Time Interval value set in par. 25-52 *Alternation Time Interval*.

**25-54 Alternation Predefined Time****Range:****Function:**

Application [Application dependent]  
dependent\*

**25-55 Alternate if Load < 50%****Option:****Function:**

If Alternation If Capacity <50% is enabled, the pump alternation can only occurs if the capacity is equal to or below 50%. The capacity calculation is the ratio of running pumps (including the variable speed pump) to the total number of available pumps (including variable speed pump, but not those interlocked).

$$Capacity = \frac{N_{RUNNING}}{N_{TOTAL}} \times 100 \%$$

For the Basic Cascade Controller all pumps are equal size.

[0]	Disabled	The lead pump alternation will take place at any pump capacity.
[1] *	Enabled	The lead pump function will be alternated only if the numbers of pumps running are providing less than 50% of total pump capacity.

**NB!**

Only valid if par. 25-50 *Lead Pump Alternation* is different from *Off*[0].

**25-56 Staging Mode at Alternation**

**Option:**

- [0] \* Slow
- [1] Quick

**Function:**

This parameter is only active if the option selected in *Lead Pump Alternation*, par. 25-50, is different from *Off*[0].

Two types of staging and destaging of pumps are possible. Slow transfer makes staging and destaging smooth. Quick Transfer makes staging and destaging as fast as possible; the variable speed pump is just cut out (coasted).

*Slow*[0]: At alternation, the variable speed pump is ramped up to maximum speed and then ramped down to a stand still.

*Quick*[1]: At alternation, the variable speed pump is ramped up to maximum speed and then coasted to stand still.

The below examples show Alternation in both Quick and Slow configurations.

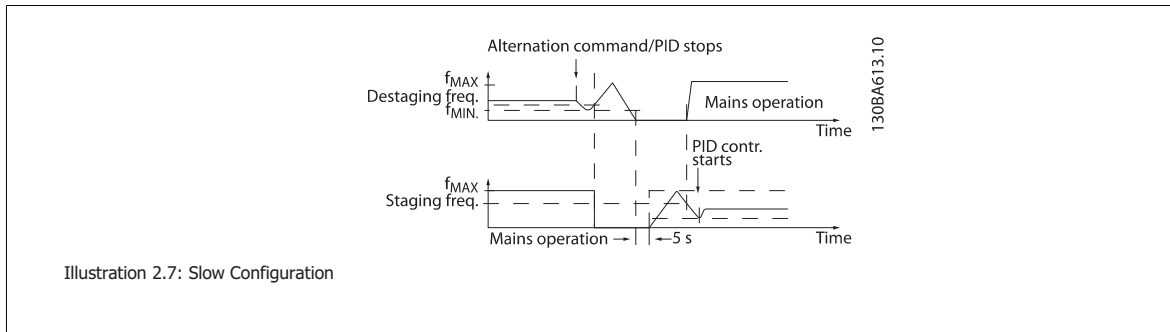

Illustration 2.7: Slow Configuration



Illustration 2.8: Quick Configuration

**25-58 Run Next Pump Delay**

**Range:**

- 0.1 s\* [0.1 - 5.0 s]

**Function:**

This parameter is only active if the option selected in par. 25-50 *Lead Pump Alternation*, is different from *Off*[0].

This parameter sets the time between stopping the old variable speed pump and starting another pump as a new variable speed pump. Refer to par. 25-56 *Staging Mode at Alternation*, the illustration for description of staging and alternation.

**25-59 Run on Mains Delay**

**Range:**

- 0.5 s\* [Application dependant]

**Function:**

This parameter is only active if the option selected in par. 25-50 *Lead Pump Alternation*, is different from *Off*[0].

This parameter sets the time between PID stopping the old variable speed pump and starting this pump as a new fixed speed pump. Refer to par. 25-56 *Staging Mode at Alternation*, the illustration for description of staging and alternation.

**2.21.6 25-8\* Status**

Readout parameters informing about the operating status of the cascade controller and the pumps controlled.

**25-80 Cascade Status****Range:**

0\* [0 - 0]

**Function:**

Read out of the status of the Cascade Controller.

**25-81 Pump Status****Range:**

0\* [0 - 0]

**Function:**

Pump Status shows the status for the number of pumps selected in par. 25-06 *Number of Pumps*. It is a readout of the status for each of the pumps showing a string, which consists of pump number and the current status of the pump.

Example: Readout is with the abbreviation like "1:D 2:O" This means that pump 1 is running and speed controlled by the frequency converter and pump 2 is stopped.

**25-82 Lead Pump****Range:**

0\* [Application dependant]

**Function:**

Readout parameter for the actual variable speed pump in the system. The Lead Pump parameter is updated to reflect the current variable speed pump in the system when an alternation takes place. If no lead pump is selected (Cascade Controller disabled or all pumps interlocked) the display will show NONE.

**25-83 Relay Status**

Array [2]

**Range:**

0\* [0 - 0]

**Function:**

Read out of the status for each of the relays assigned to control the pumps. Every element in the array represents a relay. If a relay is activated, the corresponding element is set to "On". If a relay is deactivated, the corresponding element is set to "Off".

**25-84 Pump ON Time**

Array [2]

**Range:**

0 h\* [0 - 2147483647 h]

**Function:**

Readout of the value for Pump ON Time. The Cascade Controller has separate counters for the pumps and for the relays that control the pumps. Pump ON Time monitors the "operating hours" of each pump. The value of each Pump ON Time counter can be reset to 0 by writing in the parameter, e.g. if the pump is replaced in case of service.

**25-85 Relay ON Time**

Array [2]

**Range:**

0 h\* [0 - 2147483647 h]

**Function:**

Readout of the value for Relay ON time. The Cascade Controller has separate counters for the pumps and for the relays that control the pumps. Pump cycling is always done based on the relay counters, otherwise it would always use the new pump if a pump is replaced and its value in par. 25-84 *Pump ON Time* is reset. In order to use par. 25-04 *Pump Cycling* the Cascade Controller is monitoring the Relay ON time.

**25-86 Reset Relay Counters****Option:**

[0] \* Do not reset

[1] Do reset

**Function:**Resets all elements in par. 25-85 *Relay ON Time* counters.

### 2.21.7 25-9\* Service

Parameters used in case of service on one or more of the pumps controlled.

2

#### 25-90 Pump Interlock

Array [2]

**Option:**

**Function:**

In this parameter, it is possible to disable one or more of the fixed lead pumps. For example, the pump will not be selected for staging on even if it is the next pump in the operation sequence. It is not possible to disable the lead pump with the Pump Interlock command.

The digital input interlocks are selected as *Pump 1-3 Interlock* [130 – 132] in *par. 5-1\**, *Digital Inputs*.

[0] \*      Off

The pump is active for staging/destaging.

[1]        On

The Pump Interlock command is given. If a pump is running it is immediately destaged. If the pump is not running it is not allowed to stage on.

#### 25-91 Manual Alternation

**Range:**

**Function:**

0\*        [Application dependant]

Readout parameter for the actual variable speed pump in the system. The Lead Pump parameter is updated to reflect the current variable speed pump in the system when an alternation takes place. If no lead pump is selected (Cascade Controller disabled or all pumps interlocked) the display will show NONE.

**2**

## 2.21 Main Menu - Analog I/O Option MCB 109 - Group 26

### 2.22.1 26-\*\* Analog I/O Option MCB 109

The Analog I/O Option MCB 109 extends the functionality of VLT® Automation VT Drive FC 322 Series frequency converters, by adding a number of additional, programmable analog inputs and outputs. This could be especially useful in control installations where the frequency converter may be used as decentral I/O, obviating the need for an outstation and thus reducing cost. It also gives flexibility in project planning.

**NB!**  
The maximum current for the analog outputs 0-10V is 1mA.

**NB!**  
Where Live Zero Monitoring is used, it is important that any analog inputs not being used for the frequency controller, i.e. being used as part of the Building Management System decentral I/O, should have their Live Zero function disabled.

Terminal	Parameters	Terminal	Parameters	Terminal	Parameters
Analog inputs		Analog inputs		Relays	
X42/1	26-00, 26-1*	53	6-1*	Relay 1 Term 1, 2, 3	5-4*
X42/3	26-01, 26-2*	54	6-2*	Relay 2 Term 4, 5, 6	5-4*
X42/5	26-02, 26-3*				
Analog outputs		Analog output			
X42/7	26-4*	42	6-5*		
X42/9	26-5*				
X42/11	26-6*				

Table 2.4: Relevant parameters

It is also possible to read the analog inputs, write to the analog outputs and control the relays, using communication via the serial bus. In this instance, these are the relevant parameters.

Terminal	Parameters	Terminal	Parameters	Terminal	Parameters
Analog inputs (read)		Analog inputs (read)		Relays	
X42/1	18-30	53	16-62	Relay 1 Term 1, 2, 3	16-71
X42/3	18-31	54	16-64	Relay 2 Term 4, 5, 6	16-71
X42/5	18-32				
Analog outputs (write)		Analog output			
X42/7	18-33	42	6-63	NOTE! The relay outputs must be enabled via Control Word Bit 11 (Relay 1) and Bit 12 (Relay 2)	
X42/9	18-34				
X42/11	18-35				

Table 2.5: Relevant parameters

Setting of on-board Real Time Clock.

The Analog I/O option incorporates a real time clock with battery back-up. This can be used as back up of the clock function included in the frequency converter as standard. See section Clock Settings, parameter group 0-7\*.

The Analog I/O option can be used for the control of devices such as actuators or valves, using the Extended Closed loop facility, thus removing control from the existing control system. See section Parameters: Ext. Closed Loop – FC 322 parameter group 21-\*\*. There are three independent closed loop PID controllers.

**26-00 Terminal X42/1 Mode**

Option:	Function:
	Terminal X42/1 can be programmed as an analog input accepting a voltage or input from either Pt1000 (1000 Ω at 0°C) or Ni 1000 (1000 Ω at 0°C) temperature sensors. Select the desired mode. Pt 1000, [2] and Ni 1000 [4] if operating in Celsius - Pt 1000 [3] and Ni 1000 [5] if operating in Fahrenheit. Notice: If the input is not in use, it must be set for Voltage! If set for temperature and used as feed back, the unit must be set for either Celsius or Fahrenheit (par. 20-12 Reference/Feedback Unit, par. 21-10 Ext. 1 Ref./Feedback Unit, par. 21-30 Ext. 2 Ref./Feedback Unit or par. 21-50 Ext. 3 Ref./Feedback Unit).

[1] \* Voltage

[2] Pt 1000 [°C]

[3] Pt 1000 [°F]

[4] Ni 1000 [°C]

[5] Ni 1000 [°F]

**26-01 Terminal X42/3 Mode**

Option:	Function:
	Terminal X42/3 can be programmed as an analog input accepting a voltage or input from either Pt 1000 or Ni 1000 temperature sensors. Select the desired mode. Pt 1000, [2] and Ni 1000, [4] if operating in Celsius - Pt 1000, [3] and Ni 1000, [5] if operating in Fahrenheit. Notice: If the input is not in use, it must be set for Voltage! If set for temperature and used as feed back, the unit must be set for either Celsius or Fahrenheit (par. 20-12 Reference/Feedback Unit, par. 21-10 Ext. 1 Ref./Feedback Unit, par. 21-30 Ext. 2 Ref./Feedback Unit or par. 21-50 Ext. 3 Ref./Feedback Unit).

[1] \* Voltage

[2] Pt 1000 [°C]

[3] Pt 1000 [°F]

[4] Ni 1000 [°C]

[5] Ni 1000 [°F]

**26-02 Terminal X42/5 Mode****Option:****Function:**

Terminal X42/5 can be programmed as an analog input accepting a voltage or input from either Pt 1000 (1000  $\Omega$  at 0° C) or Ni 1000 (1000  $\Omega$  at 0° C) temperature sensors. Select the desired mode. Pt 1000, [2] and Ni 1000, [4] if operating in Celsius - Pt 1000, [3] and Ni 1000, [5] if operating in Fahrenheit.

Notice: If the input is not in use, it must be set for Voltage!

If set for temperature and used as feed back, the unit must be set for either Celsius or Fahrenheit (par. 20-12 *Reference/Feedback Unit*, par. 21-10 *Ext. 1 Ref./Feedback Unit*, par. 21-30 *Ext. 2 Ref./Feedback Unit* or par. 21-50 *Ext. 3 Ref./Feedback Unit*).

[1] \* Voltage

[2] Pt 1000 [°C]

[3] Pt 1000 [°F]

[4] Ni 1000 [°C]

[5] Ni 1000 [°F]

**26-10 Terminal X42/1 Low Voltage****Range:****Function:**

0.07 V\* [Application dependant]

Enter the low voltage value. This analog input scaling value should correspond to the low reference/feedback value set in par. 26-14 *Term. X42/1 Low Ref./Feedb. Value*.

**26-11 Terminal X42/1 High Voltage****Range:****Function:**

10.00 V\* [Application dependant]

Enter the high voltage value. This analog input scaling value should correspond to the high reference/feedback value set in par. 26-15 *Term. X42/1 High Ref./Feedb. Value*.

**26-14 Term. X42/1 Low Ref./Feedb. Value****Range:****Function:**

0.000\* [-999999.999 - 999999.999 ]

Enter the analog input scaling value that corresponds to the low voltage value set in par. 26-10 *Terminal X42/1 Low Voltage*.

**26-15 Term. X42/1 High Ref./Feedb. Value****Range:****Function:**

100.000\* [-999999.999 - 999999.999 ]

Enter the analog input scaling value that corresponds to the high voltage value set in par. 26-11 *Terminal X42/1 High Voltage*.

**26-16 Term. X42/1 Filter Time Constant****Range:****Function:**

0.001 s\* [0.001 - 10.000 s]

Enter the time constant. This is a first-order digital low pass filter time constant for suppressing noise in terminal X42/1. A high time constant value improves dampening but also increases the time delay through the filter. This parameter cannot be adjusted while the motor is running.

**26-17 Term. X42/1 Live Zero****Option:****Function:**

This parameter makes it possible to enable the Live Zero monitoring. E.g. where the analog input is a part of the frequency converter control, rather than being used as part of a decentral I/O system, such as a Building Management System.

[0] Disabled

[1] \* Enabled

**26-20 Terminal X42/3 Low Voltage**

Range:	Function:
0.07 V* [Application dependent]	Enter the low voltage value. This analog input scaling value should correspond to the low reference/feedback value set in par. 26-24 <i>Term. X42/3 Low Ref./Feedb. Value.</i>

**26-21 Terminal X42/3 High Voltage**

Range:	Function:
10.00 V* [Application dependent]	Enter the high voltage value. This analog input scaling value should correspond to the high reference/feedback value set in par. 26-25 <i>Term. X42/3 High Ref./Feedb. Value.</i>

**26-24 Term. X42/3 Low Ref./Feedb. Value**

Range:	Function:
0.000* [-999999.999 - 999999.999 ]	Enter the analog input scaling value that corresponds to the low voltage value set in par. 26-20 <i>Terminal X42/3 Low Voltage.</i>

**26-25 Term. X42/3 High Ref./Feedb. Value**

Range:	Function:
100.000* [-999999.999 - 999999.999 ]	Enter the analog input scaling value that corresponds to the high voltage value set in par. 26-21 <i>Terminal X42/3 High Voltage.</i>

**26-26 Term. X42/3 Filter Time Constant**

Range:	Function:
0.001 s* [0.001 - 10.000 s]	Enter the time constant. This is a first-order digital low pass filter time constant for suppressing noise in terminal X42/3. A high time constant value improves dampening but also increases the time delay through the filter. This parameter cannot be adjusted while the motor is running.

**26-27 Term. X42/3 Live Zero**

Option:	Function:
	This parameter makes it possible to enable the Live Zero monitoring. E.g. where the analog input is a part of the frequency converter control, rather than being used as part of a decentral I/O system, such as a Building Management System.

[0] Disabled

[1] \* Enabled

**26-30 Terminal X42/5 Low Voltage**

Range:	Function:
0.07 V* [Application dependent]	Enter the low voltage value. This analog input scaling value should correspond to the low reference/feedback value set in par. 26-34 <i>Term. X42/5 Low Ref./Feedb. Value.</i>

**26-31 Terminal X42/5 High Voltage**

Range:	Function:
10.00 V* [Application dependent]	Enter the high voltage value. This analog input scaling value should correspond to the high reference/feedback value set in par. 26-35 <i>Term. X42/5 High Ref./Feedb. Value.</i>

## 2

**26-34 Term. X42/5 Low Ref./Feedb. Value****Range:**

0.000\* [-999999.999 - 999999.999 ]

**Function:**

Enter the analog input scaling value that corresponds to the low voltage value set in par. 26-30 *Terminal X42/5 Low Voltage*.

**26-35 Term. X42/5 High Ref./Feedb. Value****Range:**

100.000\* [-999999.999 - 999999.999 ]

**Function:**

Enter the analog input scaling value that corresponds to the high voltage value set in par. 26-21 *Terminal X42/3 High Voltage*.

**26-36 Term. X42/5 Filter Time Constant****Range:**

0.001 s\* [0.001 - 10.000 s]

**Function:**

Enter the time constant. This is a first-order digital low pass filter time constant for suppressing noise in terminal X42/5. A high time constant value improves dampening but also increases the time delay through the filter. This parameter cannot be adjusted while the motor is running.

**26-37 Term. X42/5 Live Zero****Option:****Function:**

This parameter makes it possible to enable the Live Zero monitoring. E.g. where the analog input is a part of the frequency converter control, rather than being used as part of a decentral I/O system, such as a Building Management System.

[0] Disabled

[1] \* Enabled

**26-40 Terminal X42/7 Output**

Option:	Function:
	Set the function of terminal X42/7 as an analog voltage output.
[0] * No operation	
[100] Output freq. 0-100	: 0 - 100 Hz, (0-20 mA)
[101] Reference Min-Max	: Minimum reference - Maximum reference, (0-20 mA)
[102] Feedback +-200%	: -200% to +200% of par. 20-14 <i>Maximum Reference/Feedb.</i> , (0-20 mA)
[103] Motor cur. 0-Imax	: 0 - Inverter Max. Current (par. 16-37 <i>Inv. Max. Current</i> ), (0-20 mA)
[104] Torque 0-Tlim	: 0 - Torque limit (par. 4-16 <i>Torque Limit Motor Mode</i> ), (0-20 mA)
[105] Torque 0-Tnom	: 0 - Motor rated torque, (0-20 mA)
[106] Power 0-Pnom	: 0 - Motor rated power, (0-20 mA)
[107] Speed 0-HighLim	: 0 - Speed High Limit (par. 4-13 <i>Motor Speed High Limit [RPM]</i> and par. 4-14 <i>Motor Speed High Limit [Hz]</i> ), (0-20 mA)
[108] Torque +-160%	
[109] Out frq 0-Fmax	
[113] Ext. Closed Loop 1	: 0 - 100%, (0-20 mA)
[114] Ext. Closed Loop 2	: 0 - 100%, (0-20 mA)
[115] Ext. Closed Loop 3	: 0 - 100%, (0-20 mA)
[139] Bus ctrl.	: 0 - 100%, (0-20 mA)
[141] Bus ctrl t.o.	: 0 - 100%, (0-20 mA)

**26-41 Terminal X42/7 Min. Scale**

Range:	Function:
0.00 %* [0.00 - 200.00 %]	Scale the minimum output of the selected analog signal at terminal X42/7, as a percentage of the maximum signal level. E.g. if a 0 V (or 0 Hz) is desired at 25% of the maximum output value. Then programme 25%. Scaling values up to 100% can never be higher than the corresponding setting in par. 26-42 <i>Terminal X42/7 Max. Scale</i> . See principle graph for par. 6-51 <i>Terminal 42 Output Min Scale</i> .

**26-42 Terminal X42/7 Max. Scale**

Range:	Function:
100.00 %* [0.00 - 200.00 %]	Scale the maximum output of the selected analog signal at terminal X42/7. Set the value to the maximum value of the voltage signal output. Scale the output to give a voltage lower than 10V at full scale; or 10V at an output below 100% of the maximum signal value. If 10V is the desired output current at a value between 0-100% of the full-scale output, programme the percentage value in the parameter, i.e. 50% = 10V. If a voltage between 0 and 10V is desired at maximum output, calculate the percentage as follows: $\left( \frac{10V}{\text{desired maximum voltage}} \right) \times 100\%$ i.e. $5V : \frac{10V}{5V} \times 100\% = 200\%$

See principle graph for par. 6-52 *Terminal 42 Output Max Scale*.

**26-43 Terminal X42/7 Bus Control**

Range:	Function:
0.00 %* [0.00 - 100.00 %]	Holds the level of terminal X42/7 if controlled by bus.

**26-44 Terminal X42/7 Timeout Preset**

Range:	Function:
0.00 %* [0.00 - 100.00 %]	Holds the preset level of terminal X42/7. In case of a bus timeout and a timeout function is selected in par. 26-50 <i>Terminal X42/9 Output</i> the output will preset to this level.

**26-50 Terminal X42/9 Output**

Option:	Function:
	Set the function of terminal X42/9.
[0] * No operation	
[100] Output freq. 0-100	: 0 - 100 Hz, (0-20 mA)
[101] Reference Min-Max	: Minimum reference - Maximum reference, (0-20 mA)
[102] Feedback +-200%	: -200% to +200% of par. 20-14 <i>Maximum Reference/Feedb.</i> , (0-20 mA)
[103] Motor cur. 0-Imax	: 0 - Inverter Max. Current (par. 16-37 <i>Inv. Max. Current</i> ), (0-20 mA)
[104] Torque 0-Tlim	: 0 - Torque limit (par. 4-16 <i>Torque Limit Motor Modè</i> ), (0-20 mA)
[105] Torque 0-Tnom	: 0 - Motor rated torque, (0-20 mA)
[106] Power 0-Pnom	: 0 - Motor rated power, (0-20 mA)
[107] Speed 0-HighLim	: 0 - Speed High Limit (par. 4-13 <i>Motor Speed High Limit [RPM]</i> and par. 4-14 <i>Motor Speed High Limit [Hz]</i> ), (0-20 mA)
[108] Torque +-160%	
[109] Out frq 0-Fmax	
[113] Ext. Closed Loop 1	: 0 - 100%, (0-20 mA)
[114] Ext. Closed Loop 2	: 0 - 100%, (0-20 mA)
[115] Ext. Closed Loop 3	: 0 - 100%, (0-20 mA)
[139] Bus ctrl.	: 0 - 100%, (0-20 mA)
[141] Bus ctrl t.o.	: 0 - 100%, (0-20 mA)

**26-51 Terminal X42/9 Min. Scale**

Range:	Function:
0.00 %* [0.00 - 200.00 %]	Scale the minimum output of the selected analog signal at terminal X42/9, as a percentage of the maximum signal level. E.g. if a 0 V is desired at 25% of the maximum output value. Then programme 25%. Scaling values up to 100% can never be higher than the corresponding setting in par. 26-52 <i>Terminal X42/9 Max. Scale</i> .

See principle graph for par. 6-51 *Terminal 42 Output Min Scale*.

**26-52 Terminal X42/9 Max. Scale**

Range:	Function:
100.00 %* [0.00 - 200.00 %]	<p>Scale the maximum output of the selected analog signal at terminal X42/9. Set the value to the maximum value of the voltage signal output. Scale the output to give a voltage lower than 10V at full scale; or 10V at an output below 100% of the maximum signal value. If 10V is the desired output current at a value between 0-100% of the full-scale output, programme the percentage value in the parameter, i.e. 50% = 10V. If a voltage between 0 and 10V is desired at maximum output, calculate the percentage as follows:</p> $\left(\frac{10V}{\text{desired maximum voltage}}\right) \times 100\%$ <p>i.e.</p> $5V : \frac{10V}{5V} \times 100\% = 200\%$

See principle graph for par. 6-52 *Terminal 42 Output Max Scale*.

**26-53 Terminal X42/9 Bus Control**

Range:	Function:
0.00 %* [0.00 - 100.00 %]	Holds the level of terminal X42/9 if controlled by bus.

**26-54 Terminal X42/9 Timeout Preset**

Range:	Function:
0.00 %* [0.00 - 100.00 %]	<p>Holds the preset level of terminal X42/9.</p> <p>In case of a bus timeout and a timeout function is selected in par. 26-60 <i>Terminal X42/11 Output</i> the output will preset to this level.</p>

**26-60 Terminal X42/11 Output**

Option:	Function:
	Set the function of terminal X42/11.
[0] * No operation	
[100] Output freq. 0-100	: 0 - 100 Hz, (0-20 mA)
[101] Reference Min-Max	: Minimum reference - Maximum reference, (0-20 mA)
[102] Feedback +-200%	: -200% to +200% of par. 20-14 <i>Maximum Reference/Feedb.</i> , (0-20 mA)
[103] Motor cur. 0-Imax	: 0 - Inverter Max. Current (par. 16-37 <i>Inv. Max. Current</i> ), (0-20 mA)
[104] Torque 0-Tlim	: 0 - Torque limit (par. 4-16 <i>Torque Limit Motor Mode</i> ), (0-20 mA)
[105] Torque 0-Tnom	: 0 - Motor rated torque, (0-20 mA)
[106] Power 0-Pnom	: 0 - Motor rated power, (0-20 mA)
[107] Speed 0-HighLim	: 0 - Speed High Limit (par. 4-13 <i>Motor Speed High Limit [RPM]</i> and par. 4-14 <i>Motor Speed High Limit [Hz]</i> ), (0-20 mA)
[108] Torque +-160%	
[109] Out frq 0-Fmax	
[113] Ext. Closed Loop 1	: 0 - 100%, (0-20 mA)
[114] Ext. Closed Loop 2	: 0 - 100%, (0-20 mA)
[115] Ext. Closed Loop 3	: 0 - 100%, (0-20 mA)
[139] Bus ctrl.	: 0 - 100%, (0-20 mA)

[141] Bus ctrl t.o. : 0 - 100%, (0-20 mA)

**2**

**26-61 Terminal X42/11 Min. Scale**

Range:	Function:
0.00 %* [0.00 - 200.00 %]	Scale the minimum output of the selected analog signal at terminal X42/11, as a percentage of the maximum signal level. E.g. if a 0 V is desired at 25% of the maximum output value. Then programme 25%. Scaling values up to 100% can never be higher than the corresponding setting in par. 26-62 <i>Terminal X42/11 Max. Scale</i> .

See principle graph for par. 6-51 *Terminal 42 Output Min Scale*.

**26-62 Terminal X42/11 Max. Scale**

Range:	Function:
100.00 %* [0.00 - 200.00 %]	Scale the maximum output of the selected analog signal at terminal X42/9. Set the value to the maximum value of the voltage signal output. Scale the output to give a voltage lower than 10V at full scale; or 10V at an output below 100% of the maximum signal value. If 10V is the desired output current at a value between 0-100% of the full-scale output, programme the percentage value in the parameter, i.e. 50% = 10V. If a voltage between 0 and 10V is desired at maximum output, calculate the percentage as follows: $\left( \frac{10V}{\text{desired maximum voltage}} \right) \times 100\%$ i.e. $5V : \frac{10V}{5V} \times 100\% = 200\%$

See principle graph for par. 6-52 *Terminal 42 Output Max Scale*.

**26-63 Terminal X42/11 Bus Control**

Range:	Function:
0.00 %* [0.00 - 100.00 %]	Holds the level of terminal X42/11 if controlled by bus.

**26-64 Terminal X42/11 Timeout Preset**

Range:	Function:
0.00 %* [0.00 - 100.00 %]	Holds the preset level of terminal X42/11. In case a bus time-out and a time-out function are selected, the output will preset to this level.

## 2.22 Main menu – Water application – Group 29

### 2.23.1 29-\*\* Water Application Functions

**2**

The group contains parameters used for monitoring water / wastewater applications.

### 2.23.2 29-0\* Pipe Fill function

In water supply systems water hammering can occur when filling the pipes too fast. It is therefore desirable to limit the filling rate. Pipe Fill Mode eliminates the occurrence of water hammering associated with the rapid exhausting of air from the piping system by filling the pipes at a low rate.

This function is used in horizontal, vertical and mixed piping systems. Due to the fact that the pressure in horizontal pipe systems does not climb as the system fills, filling horizontal pipe systems requires a user specified speed to fill, for a user specified time and/or until a user specified pressure set-point is reached.

The best way to fill a vertical pipe system is to use the PID function to ramp the pressure at a user specified rate between the motor speed low limit and a user specified pressure.

The Pipe Fill function uses a combination of above to ensure a safe filling in any system.

No matter which system - the pipe fill-mode will start using the constant speed set in par. 29-01 until the pipe fill-time in par. 29-03 has expired, thereafter filling will continue with the filling ramp set in par. 29-04 until the filling set-point specified in par. 29-05 is reached.

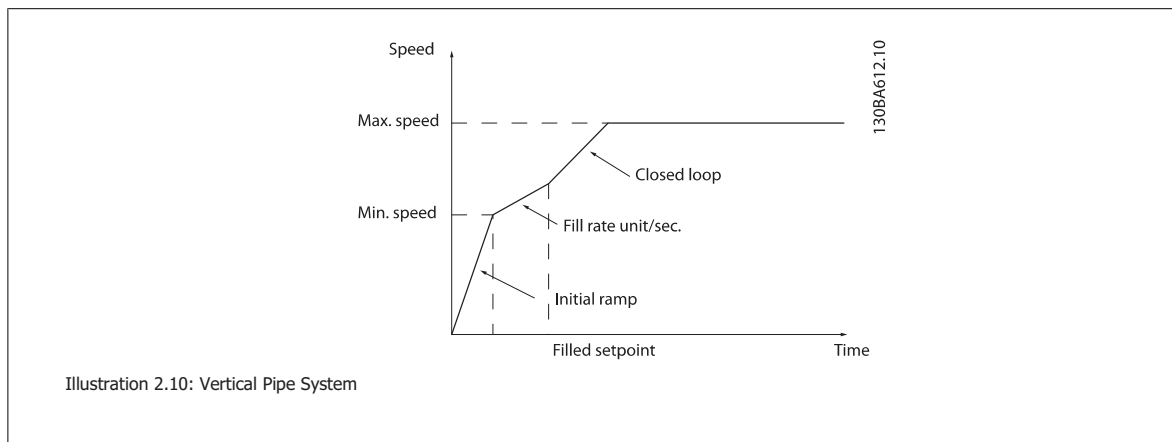
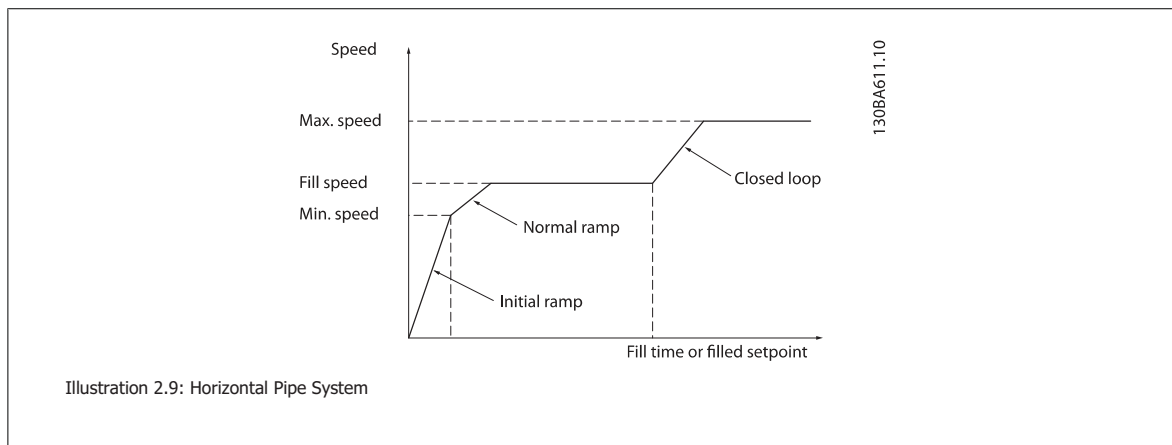

**29-00 Pipe Fill Enable**

Option:	Function:
[0] * Disabled	Select Enabled to fill pipes at a user specified rate.
[1] Enabled	Select Enabled to fill pipes with a user specified rate.

**29-01 Pipe Fill Speed [RPM]**

Range:	Function:
Speed Low [Speed Low Limit - Speed High Limit* it]	Set the filling speed for filling horizontal pipe systems. The speed can be selected in Hz or RPM depending on the choices made in par. 4-11 / par. 4-13 (RPM) or in par. 4-12 / par. 4-14 (Hz).

**29-02 Pipe Fill Speed [Hz]**

Range:	Function:
Motor Speed Low it] Limit*	Set the filling speed for filling horizontal pipe systems. The speed can be selected in Hz or RPM depending on the choices made in par. 4-11 / par. 4-13 (RPM) or in par. 4-12 / par. 4-14 (Hz).

**29-03 Pipe Fill Time**

Range:	Function:
0 s* [0 - 3600 s]	Set the specified time for pipe filling of horizontal pipe systems.

**29-04 Pipe Fill Rate**

Range:	Function:
0.001 units/s* [0.001 – 999999.999 units/s]	Specifies the filling rate in units/second using the PI controller. Filling rate units are feedback units/second. This function is used for filling-up vertical pipe systems but will be active when the filling-time has expired, no matter what , until the pipe fill-set-point set in par. 29-05 is reached.

**29-05 Filled Setpoint**

Range:	Function:
0 s* [0 – 999999,999 s]	Specifies the Filled Set-point at which the Pipe Fill Function will be disabled and the PID controller will take control. This function can be used both for horizontal and vertical pipe systems.

## 2.23 Main Menu - Bypass Option - Group 31

### 2.24.1 31-\*\* Bypass Option

2

Parameter group for the configuration of the electronically controlled bypass option board, MCO-104.

#### 31-00 Bypass Mode

**Option:**

[0] \* Drive

**Function:**

[1] Bypass feature: Bypass

Select the operating mode of the bypass:  
 [0] Drive: the motor is operated by the drive.  
 [1] Bypass: motor can be run at full speed in bypass mode.

#### 31-01 Bypass Start Time Delay

**Range:**

30 s\* [0 - 60 s]

**Function:**

Set the time delay within the time when the bypass receives a run command and the time when it starts the motor at full speed. A countdown timer will display time left.

#### 31-02 Bypass Trip Time Delay

**Range:**

0 s\* [0 - 300 s]

**Function:**

Set the time delay within the time that the drive experiences an alarm that stops it and the time when the motor is automatically switched to bypass control. If the time delay is set to zero, then a drive alarm will not automatically switch the motor to bypass control.

#### 31-03 Test Mode Activation

**Option:**

[0] \* Disabled

**Function:**

[1] Enabled

[0] Disabled, means that the Test Mode is disabled.  
 [1] Enabled, means that the motor runs in bypass, while the drive can be tested in an open circuit. In this mode the keypad will not control start/stop of the bypass.

#### 31-10 Bypass Status Word

**Range:**

0\* [0 - 65535]

**Function:**

Views the status of the bypass as a hexadecimal value.

#### 31-11 Bypass Running Hours

**Range:**

0 hr\* [0 - 2147483647 hrs]

**Function:**

Views the number of hours in which the motor has run in Bypass Mode. The counter can be reset in par. 15-07. The value is saved, when the frequency converter is turned off.

#### 31-19 Remote Bypass Activation

**Option:**

[0] \* Disabled

**Function:**

[1] Enabled

Feature: Unknown.

## 3 Parameter Lists

### 3.1 Parameter Options

#### 3.1.1 Default settings

Changes during operation:

"TRUE" means that the parameter can be changed while the frequency converter is in operation and "FALSE" means that the frequency converter must be stopped before a change can be made.



4-Set-up:

'All set-up': the parameter can be set individually in each of the four set-ups, i. e. one single parameter can have four different data values.

'1 set-up': data value will be the same in all set-ups.

SR:

Size related

N/A:

No default value available.

Conversion index:

This number refers to a conversion figure used when writing or reading by means of a frequency converter.

<b>Conv. index</b>	100	67	6	5	4	3	2	1	0	-1	-2	-3	-4	-5	-6
<b>Conv. factor</b>	1	1/60	1000000	100000	10000	1000	100	10	1	0.1	0.01	0.001	0.0001	0.00001	0.000001

Data type	Description	Type
2	Integer 8	Int8
3	Integer 16	Int16
4	Integer 32	Int32
5	Unsigned 8	UInt8
6	Unsigned 16	UInt16
7	Unsigned 32	UInt32
9	Visible String	VisStr
33	Normalized value 2 bytes	N2
35	Bit sequence of 16 boolean variables	V2
54	Time difference w/o date	TimD

### 3.1.2 Operation/Display 0-\*\*\*

Par. No. #	Parameter description	Default value	4-set-up	Change during operation	Conversion index	Type
<b>0-0* Basic Settings</b>						
0-01	Language	[0] English	1 set-up	TRUE	-	Uint8
0-02	Motor Speed Unit	[0] RPM	2 set-ups	FALSE	-	Uint8
0-03	Regional Settings	[0] International	2 set-ups	FALSE	-	Uint8
0-04	Operating State at Power-up	[0] Resume	All set-ups	TRUE	-	Uint8
0-05	Local Mode Unit	[0] As Motor Speed Unit	2 set-ups	FALSE	-	Uint8
<b>0-1* Set-up Operations</b>						
0-10	Active Set-up	[1] Set-up 1	1 set-up	TRUE	-	Uint8
0-11	Programming Set-up	[9] Active Set-up	All set-ups	TRUE	-	Uint8
0-12	This Set-up Linked to	[0] Not linked	All set-ups	FALSE	-	Uint8
0-13	Readout: Linked Set-ups	0 N/A	All set-ups	FALSE	0	Uint16
0-14	Readout: Prog. Set-ups / Channel	0 N/A	All set-ups	TRUE	0	Int32
<b>0-2* LCP Display</b>						
0-20	Display Line 1.1 Small	1601	All set-ups	TRUE	-	Uint16
0-21	Display Line 1.2 Small	1662	All set-ups	TRUE	-	Uint16
0-22	Display Line 1.3 Small	1614	All set-ups	TRUE	-	Uint16
0-23	Display Line 2 Large	1613	All set-ups	TRUE	-	Uint16
0-24	Display Line 3 Large	1652	All set-ups	TRUE	-	Uint16
0-25	My Personal Menu	SR	1 set-up	TRUE	0	Uint16
<b>0-3* LCP Custom Readout</b>						
0-30	Custom Readout Unit	[1] %	All set-ups	TRUE	-	Uint8
0-31	Custom Readout Min Value	SR	All set-ups	TRUE	-2	Int32
0-32	Custom Readout Max Value	100.00 CustomReadoutUnit	All set-ups	TRUE	-2	Int32
0-37	Display Text 1	0 N/A	1 set-up	TRUE	0	VisStr[25]
0-38	Display Text 2	0 N/A	1 set-up	TRUE	0	VisStr[25]
0-39	Display Text 3	0 N/A	1 set-up	TRUE	0	VisStr[25]
<b>0-4* LCP Keypad</b>						
0-40	[Hand on] Key on LCP	[1] Enabled	All set-ups	TRUE	-	Uint8
0-41	[Off] Key on LCP	[1] Enabled	All set-ups	TRUE	-	Uint8
0-42	[Auto on] Key on LCP	[1] Enabled	All set-ups	TRUE	-	Uint8
0-43	[Reset] Key on LCP	[1] Enabled	All set-ups	TRUE	-	Uint8
0-44	[Off/Reset] Key on LCP	[1] Enabled	All set-ups	TRUE	-	Uint8
0-45	[Drive Bypass] key on LCP	[1] Enabled	All set-ups	TRUE	-	Uint8
<b>0-5* Copy/Save</b>						
0-50	LCP Copy	[0] No copy	All set-ups	FALSE	-	Uint8
0-51	Set-up Copy	[0] No copy	All set-ups	FALSE	-	Uint8

Par. No. #	Parameter description	Default value	4-set-up	Change during operation	Conversion index	Type
<b>0-6* Password</b>						
0-60	Main Menu Password	100 N/A	1 set-up	TRUE	0	Uint16
0-61	Access to Main Menu w/o Password	[0] Full access	1 set-up	TRUE	-	Uint8
0-65	Personal Menu Password	200 N/A	1 set-up	TRUE	0	Uint16
0-66	Access to Personal Menu w/o Password	[0] Full access	1 set-up	TRUE	-	Uint8
<b>0-7* Clock Settings</b>						
0-70	Date and Time	SR	All set-ups	TRUE	0	TimeOfDay
0-71	Date Format	[0] YYYY-MM-DD	1 set-up	TRUE	-	Uint8
0-72	Time Format	[0] 24 h	1 set-up	TRUE	-	Uint8
0-74	DST/Summertime	[0] Off	1 set-up	TRUE	-	Uint8
0-76	DST/Summertime Start	SR	1 set-up	TRUE	0	TimeOfDay
0-77	DST/Summertime End	SR	1 set-up	TRUE	0	TimeOfDay
0-79	Clock Fault	null	1 set-up	TRUE	-	Uint8
0-81	Working Days	null	1 set-up	TRUE	-	Uint8
0-82	Additional Working Days	SR	1 set-up	TRUE	0	TimeOfDay
0-83	Additional Non-Working Days	SR	1 set-up	TRUE	0	TimeOfDay
0-89	Date and Time Readout	0 N/A	All set-ups	TRUE	0	VisStr[25]

3

**3.1.3 Load/Motor 1-\*\*-**

Par. No. #	Parameter description	Default value	4-set-up	Change during operation	Conversion index	Type
<b>1-0* General Settings</b>						
1-00	Configuration Mode	null	All set-ups	TRUE	-	Uint8
1-01	Motor Control Principle	null	All set-ups	FALSE	-	Uint8
1-03	Torque Characteristics	[3] Auto Energy Optim. VT	All set-ups	TRUE	-	Uint8
<b>1-1* Motor Selection</b>						
1-10	Motor Construction	[0] Asynchron	All set-ups	FALSE	-	Uint8
<b>1-2* Motor Data</b>						
1-20	Motor Power [kW]	SR	All set-ups	FALSE	1	Uint32
1-21	Motor Power [HP]	SR	All set-ups	FALSE	-2	Uint32
1-22	Motor Voltage	SR	All set-ups	FALSE	0	Uint16
1-23	Motor Frequency	SR	All set-ups	FALSE	0	Uint16
1-24	Motor Current	SR	All set-ups	FALSE	-2	Uint32
1-25	Motor Nominal Speed	SR	All set-ups	FALSE	67	Uint16
1-28	Motor Rotation Check	[0] Off	All set-ups	FALSE	-	Uint8
1-29	Automatic Motor Adaptation (AMA)	[0] Off	All set-ups	FALSE	-	Uint8
<b>1-3* Adv. Motor Data</b>						
1-30	Stator Resistance (Rs)	SR	All set-ups	FALSE	-4	Uint32
1-31	Rotor Resistance (Rr)	SR	All set-ups	FALSE	-4	Uint32
1-32	Stator Reactance (Xs)	SR	All set-ups	FALSE	-4	Uint32
1-33	Stator Leakage Reactance (X1)	SR	All set-ups	FALSE	-4	Uint32
1-34	Rotor Leakage Reactance (X2)	SR	All set-ups	FALSE	-4	Uint32
1-35	Main Reactance (Xh)	SR	All set-ups	FALSE	-4	Uint32
1-36	Iron Loss Resistance (Rfe)	SR	All set-ups	FALSE	-3	Uint32
1-39	Motor Poles	SR	All set-ups	FALSE	0	Uint8
<b>1-5* Load Indep. Setting</b>						
1-50	Motor Magnetisation at Zero Speed	100 %	All set-ups	TRUE	0	Uint16
1-51	Min Speed Normal Magnetising [RPM]	SR	All set-ups	TRUE	67	Uint16
1-52	Min Speed Normal Magnetising [Hz]	SR	All set-ups	TRUE	-1	Uint16
1-55	V/f Characteristic - V	SR	All set-ups	TRUE	-1	Uint16
1-56	V/f Characteristic - f	SR	All set-ups	TRUE	-1	Uint16
<b>1-6* Load Depen. Setting</b>						
1-60	Low Speed Load Compensation	100 %	All set-ups	TRUE	0	Int16
1-61	High Speed Load Compensation	100 %	All set-ups	TRUE	0	Int16
1-62	Slip Compensation	0 %	All set-ups	TRUE	0	Int16
1-63	Slip Compensation Time Constant	SR	All set-ups	TRUE	-2	Uint16
1-64	Resonance Dampening	100 %	All set-ups	TRUE	0	Uint16
1-65	Resonance Dampening Time Constant	5 ms	All set-ups	TRUE	-3	Uint8
<b>1-7* Start Adjustments</b>						
1-71	Start Delay	0.0 s	All set-ups	TRUE	-1	Uint16
1-73	Flying Start	[0] Disabled	All set-ups	FALSE	-	Uint8
1-74	Start Speed [RPM]	SR	All set-ups	TRUE	67	Uint16
1-75	Start Speed [Hz]	SR	All set-ups	TRUE	-1	Uint16
1-76	Start Current	0.00 A	All set-ups	TRUE	-2	Uint32

Par. No. #	Parameter description	Default value	4-set-up	Change during operation	Conversion index	Type
<b>1-8* Stop Adjustments</b>						
1-80	Function at Stop	[0] Coast	All set-ups	TRUE	-	Uint8
1-81	Min Speed for Function at Stop [RPM]	SR	All set-ups	TRUE	67	Uint16
1-82	Min Speed for Function at Stop [Hz]	SR	All set-ups	TRUE	-1	Uint16
1-86	Trip Speed Low [RPM]	0 RPM	All set-ups	TRUE	67	Uint16
1-87	Trip Speed Low [Hz]	0 Hz	All set-ups	TRUE	-1	Uint16
<b>1-9* Motor Temperature</b>						
1-90	Motor Thermal Protection	[4] ETR trip 1	All set-ups	TRUE	-	Uint8
1-91	Motor External Fan	[0] No	All set-ups	TRUE	-	Uint16
1-93	Thermistor Source	[0] None	All set-ups	TRUE	-	Uint8

**3.1.4 Brakes 2-\*\*-**

Par. No. #	Parameter description	Default value	4-set-up	Change during operation	Conversion index	Type
<b>2-0* DC-Brake</b>						
2-00	DC Hold/Preheat Current	50 %	All set-ups	TRUE	0	Uint8
2-01	DC Brake Current	50 %	All set-ups	TRUE	0	Uint16
2-02	DC Braking Time	10.0 s	All set-ups	TRUE	-1	Uint16
2-03	DC Brake Cut In Speed [RPM]	SR	All set-ups	TRUE	67	Uint16
2-04	DC Brake Cut In Speed [Hz]	SR	All set-ups	TRUE	-1	Uint16
<b>2-1* Brake Energy Funct.</b>						
2-10	Brake Function	[0] Off	All set-ups	TRUE	-	Uint8
2-11	Brake Resistor (ohm)	SR	All set-ups	TRUE	0	Uint16
2-12	Brake Power Limit (kW)	SR	All set-ups	TRUE	0	Uint32
2-13	Brake Power Monitoring	[0] Off	All set-ups	TRUE	-	Uint8
2-15	Brake Check	[0] Off	All set-ups	TRUE	-	Uint8
2-16	AC brake Max. Current	100.0 %	All set-ups	TRUE	-1	Uint32
2-17	Over-voltage Control	[2] Enabled	All set-ups	TRUE	-	Uint8

### 3.1.5 Reference / Ramps 3-\*\*-\*

Par. No. #	Parameter description	Default value	4-set-up	Change during operation	Conversion index	Type
<b>3-0* Reference Limits</b>						
3-02	Minimum Reference	SR	All set-ups	TRUE	-3	Int32
3-03	Maximum Reference	SR	All set-ups	TRUE	-3	Int32
3-04	Reference Function	[0] Sum	All set-ups	TRUE	-	UInt8
<b>3-1* References</b>						
3-10	Preset Reference	0.00 %	All set-ups	TRUE	-2	Int16
3-11	Jog Speed [Hz]	SR	All set-ups	TRUE	-1	UInt16
3-13	Reference Site	[0] Linked to Hand / Auto	All set-ups	TRUE	-	UInt8
3-14	Preset Relative Reference	0.00 %	All set-ups	TRUE	-2	Int32
3-15	Reference 1 Source	[1] Analog input 53	All set-ups	TRUE	-	UInt8
3-16	Reference 2 Source	[0] No function	All set-ups	TRUE	-	UInt8
3-17	Reference 3 Source	[0] No function	All set-ups	TRUE	-	UInt8
3-19	Jog Speed [RPM]	SR	All set-ups	TRUE	67	UInt16
<b>3-4* Ramp 1</b>						
3-41	Ramp 1 Ramp Up Time	SR	All set-ups	TRUE	-2	UInt32
3-42	Ramp 1 Ramp Down Time	SR	All set-ups	TRUE	-2	UInt32
<b>3-5* Ramp 2</b>						
3-51	Ramp 2 Ramp Up Time	SR	All set-ups	TRUE	-2	UInt32
3-52	Ramp 2 Ramp Down Time	SR	All set-ups	TRUE	-2	UInt32
<b>3-8* Other Ramps</b>						
3-80	Jog Ramp Time	SR	All set-ups	TRUE	-2	UInt32
3-81	Quick Stop Ramp Time	SR	2 set-ups	TRUE	-2	UInt32
3-84	Initial Ramp Time	0.00 s	All set-ups	TRUE	-2	UInt16
3-85	Check Valve Ramp Time	0.00 s	All set-ups	TRUE	-2	UInt16
3-86	Check Valve Ramp End Speed [RPM]	SR	All set-ups	TRUE	67	UInt16
3-87	Check Valve Ramp End Speed [Hz]	SR	All set-ups	TRUE	-1	UInt16
3-88	Final Ramp Time	0.00 s	All set-ups	TRUE	-2	UInt16
<b>3-9* Digital Pot.Meter</b>						
3-90	Step Size	0.10 %	All set-ups	TRUE	-2	UInt16
3-91	Ramp Time	1.00 s	All set-ups	TRUE	-2	UInt32
3-92	Power Restore	[0] Off	All set-ups	TRUE	-	UInt8
3-93	Maximum Limit	100 %	All set-ups	TRUE	0	Int16
3-94	Minimum Limit	0 %	All set-ups	TRUE	0	Int16
3-95	Ramp Delay	SR	All set-ups	TRUE	-3	TimD

**3.1.6 Limits / Warnings 4-\*\*-**

Par. No. #	Parameter description	Default value	4-set-up	Change during operation	Conversion index	Type
<b>4-1* Motor Limits</b>						
4-10	Motor Speed Direction	[0] Clockwise	All set-ups	FALSE	-	UInt8
4-11	Motor Speed Low Limit [RPM]	SR	All set-ups	TRUE	67	UInt16
4-12	Motor Speed Low Limit [Hz]	SR	All set-ups	TRUE	-1	UInt16
4-13	Motor Speed High Limit [RPM]	SR	All set-ups	TRUE	67	UInt16
4-14	Motor Speed High Limit [Hz]	SR	All set-ups	TRUE	-1	UInt16
4-16	Torque Limit Motor Mode	SR	All set-ups	TRUE	-1	UInt16
4-17	Torque Limit Generator Mode	100.0 %	All set-ups	TRUE	-1	UInt16
4-18	Current Limit	SR	All set-ups	TRUE	-1	UInt32
4-19	Max Output Frequency	SR	All set-ups	FALSE	-1	UInt16
<b>4-5* Adj. Warnings</b>						
4-50	Warning Current Low	0.00 A	All set-ups	TRUE	-2	UInt32
4-51	Warning Current High	ImaxVLT (P1637)	All set-ups	TRUE	-2	UInt32
4-52	Warning Speed Low	0 RPM	All set-ups	TRUE	67	UInt16
4-53	Warning Speed High	outputSpeedHighLimit (P413)	All set-ups	TRUE	67	UInt16
4-54	Warning Reference Low	-999999,999 N/A	All set-ups	TRUE	-3	Int32
4-55	Warning Reference High	999999,999 N/A	All set-ups	TRUE	-3	Int32
4-56	Warning Feedback Low	-999999,999 ReferenceFeedbackUnit	All set-ups	TRUE	-3	Int32
4-57	Warning Feedback High	999999,999 ReferenceFeedbackUnit	All set-ups	TRUE	-3	Int32
4-58	Missing Motor Phase Function	[2] Trip 1000 ms	All set-ups	TRUE	-	UInt8
<b>4-6* Speed Bypass</b>						
4-60	Bypass Speed From [RPM]	SR	All set-ups	TRUE	67	UInt16
4-61	Bypass Speed From [Hz]	SR	All set-ups	TRUE	-1	UInt16
4-62	Bypass Speed To [RPM]	SR	All set-ups	TRUE	67	UInt16
4-63	Bypass Speed To [Hz]	SR	All set-ups	TRUE	-1	UInt16
4-64	Semi-Auto Bypass Set-up	[0] Off	All set-ups	FALSE	-	UInt8

### 3.1.7 Digital In/Out 5-\*\*-\*

Par. No. #	Parameter description	Default value	4-set-up	Change during operation	Conversion index	Type
<b>5-0* Digital I/O mode</b>						
5-00	Digital I/O Mode	[0] PNP - Active at 24V	All set-ups	FALSE	-	Uint8
5-01	Terminal 27 Mode	[0] Input	All set-ups	TRUE	-	Uint8
5-02	Terminal 29 Mode	[0] Input	All set-ups	TRUE	-	Uint8
<b>5-1* Digital Inputs</b>						
5-10	Terminal 18 Digital Input	[8] Start	All set-ups	TRUE	-	Uint8
5-11	Terminal 19 Digital Input	[0] No operation	All set-ups	TRUE	-	Uint8
5-12	Terminal 27 Digital Input	null	All set-ups	TRUE	-	Uint8
5-13	Terminal 29 Digital Input	[0] No operation	All set-ups	TRUE	-	Uint8
5-14	Terminal 32 Digital Input	[0] No operation	All set-ups	TRUE	-	Uint8
5-15	Terminal 33 Digital Input	[0] No operation	All set-ups	TRUE	-	Uint8
5-16	Terminal X30/2 Digital Input	[0] No operation	All set-ups	TRUE	-	Uint8
5-17	Terminal X30/3 Digital Input	[0] No operation	All set-ups	TRUE	-	Uint8
5-18	Terminal X30/4 Digital Input	[0] No operation	All set-ups	TRUE	-	Uint8
<b>5-3* Digital Outputs</b>						
5-30	Terminal 27 Digital Output	[0] No operation	All set-ups	TRUE	-	Uint8
5-31	Terminal 29 Digital Output	[0] No operation	All set-ups	TRUE	-	Uint8
5-32	Term X30/6 Digi Out (MCB 101)	[0] No operation	All set-ups	TRUE	-	Uint8
5-33	Term X30/7 Digi Out (MCB 101)	[0] No operation	All set-ups	TRUE	-	Uint8
<b>5-4* Relays</b>						
5-40	Function Relay	null	All set-ups	TRUE	-	Uint8
5-41	On Delay, Relay	0.01 s	All set-ups	TRUE	-2	Uint16
5-42	Off Delay, Relay	0.01 s	All set-ups	TRUE	-2	Uint16
<b>5-5* Pulse Input</b>						
5-50	Term. 29 Low Frequency	100 Hz	All set-ups	TRUE	0	Uint32
5-51	Term. 29 High Frequency	100 Hz	All set-ups	TRUE	0	Uint32
5-52	Term. 29 Low Ref./Feedb. Value	0.000 N/A	All set-ups	TRUE	-3	Int32
5-53	Term. 29 High Ref./Feedb. Value	100.000 N/A	All set-ups	TRUE	-3	Int32
5-54	Pulse Filter Time Constant #29	100 ms	All set-ups	FALSE	-3	Uint16
5-55	Term. 33 Low Frequency	100 Hz	All set-ups	TRUE	0	Uint32
5-56	Term. 33 High Frequency	100 Hz	All set-ups	TRUE	0	Uint32
5-57	Term. 33 Low Ref./Feedb. Value	0.000 N/A	All set-ups	TRUE	-3	Int32
5-58	Term. 33 High Ref./Feedb. Value	100.000 N/A	All set-ups	TRUE	-3	Int32
5-59	Pulse Filter Time Constant #33	100 ms	All set-ups	FALSE	-3	Uint16
<b>5-6* Pulse Output</b>						
5-60	Terminal 27 Pulse Output Variable	[0] No operation	All set-ups	TRUE	-	Uint8
5-62	Pulse Output Max Freq #27	5000 Hz	All set-ups	TRUE	0	Uint32
5-63	Terminal 29 Pulse Output Variable	[0] No operation	All set-ups	TRUE	-	Uint8
5-65	Pulse Output Max Freq #29	5000 Hz	All set-ups	TRUE	0	Uint32
5-66	Terminal X30/6 Pulse Output Variable	[0] No operation	All set-ups	TRUE	-	Uint8
5-68	Pulse Output Max Freq #X30/6	5000 Hz	All set-ups	TRUE	0	Uint32
<b>5-9* Bus Controlled</b>						
5-90	Digital & Relay Bus Control	0 N/A	All set-ups	TRUE	0	Uint32
5-93	Pulse Out #27 Bus Control	0.00 %	All set-ups	TRUE	-2	N2
5-94	Pulse Out #27 Timeout Preset	0.00 %	1 set-up	TRUE	-2	Uint16
5-95	Pulse Out #29 Bus Control	0.00 %	All set-ups	TRUE	-2	N2
5-96	Pulse Out #29 Timeout Preset	0.00 %	1 set-up	TRUE	-2	Uint16
5-97	Pulse Out #X30/6 Bus Control	0.00 %	All set-ups	TRUE	-2	N2
5-98	Pulse Out #X30/6 Timeout Preset	0.00 %	1 set-up	TRUE	-2	Uint16

### 3.1.8 Analog In/Out 6-\*\*

Par. No. #	Parameter description	Default value	4-set-up	Change during operation	Conversion index	Type
<b>6-0* Analog I/O Mode</b>						
6-00	Live Zero Timeout Time	10 s	All set-ups	TRUE	0	Uint8
6-01	Live Zero Timeout Function	[0] Off	All set-ups	TRUE	-	Uint8
<b>6-1* Analog Input 53</b>						
6-10	Terminal 53 Low Voltage	0.07 V	All set-ups	TRUE	-2	Int16
6-11	Terminal 53 High Voltage	10.00 V	All set-ups	TRUE	-2	Int16
6-12	Terminal 53 Low Current	4.00 mA	All set-ups	TRUE	-5	Int16
6-13	Terminal 53 High Current	20.00 mA	All set-ups	TRUE	-5	Int16
6-14	Terminal 53 Low Ref./Feedb. Value	0.000 N/A	All set-ups	TRUE	-3	Int32
6-15	Terminal 53 High Ref./Feedb. Value	SR	All set-ups	TRUE	-3	Int32
6-16	Terminal 53 Filter Time Constant	0.001 s	All set-ups	TRUE	-3	Uint16
6-17	Terminal 53 Live Zero	[1] Enabled	All set-ups	TRUE	-	Uint8
<b>6-2* Analog Input 54</b>						
6-20	Terminal 54 Low Voltage	0.07 V	All set-ups	TRUE	-2	Int16
6-21	Terminal 54 High Voltage	10.00 V	All set-ups	TRUE	-2	Int16
6-22	Terminal 54 Low Current	4.00 mA	All set-ups	TRUE	-5	Int16
6-23	Terminal 54 High Current	20.00 mA	All set-ups	TRUE	-5	Int16
6-24	Terminal 54 Low Ref./Feedb. Value	0.000 N/A	All set-ups	TRUE	-3	Int32
6-25	Terminal 54 High Ref./Feedb. Value	100.000 N/A	All set-ups	TRUE	-3	Int32
6-26	Terminal 54 Filter Time Constant	0.001 s	All set-ups	TRUE	-3	Uint16
6-27	Terminal 54 Live Zero	[1] Enabled	All set-ups	TRUE	-	Uint8
<b>6-3* Analog Input X30/11</b>						
6-30	Terminal X30/11 Low Voltage	0.07 V	All set-ups	TRUE	-2	Int16
6-31	Terminal X30/11 High Voltage	10.00 V	All set-ups	TRUE	-2	Int16
6-34	Term. X30/11 Low Ref./Feedb. Value	0.000 N/A	All set-ups	TRUE	-3	Int32
6-35	Term. X30/11 High Ref./Feedb. Value	100.000 N/A	All set-ups	TRUE	-3	Int32
6-36	Term. X30/11 Filter Time Constant	0.001 s	All set-ups	TRUE	-3	Uint16
6-37	Term. X30/11 Live Zero	[1] Enabled	All set-ups	TRUE	-	Uint8
<b>6-4* Analog Input X30/12</b>						
6-40	Terminal X30/12 Low Voltage	0.07 V	All set-ups	TRUE	-2	Int16
6-41	Terminal X30/12 High Voltage	10.00 V	All set-ups	TRUE	-2	Int16
6-44	Term. X30/12 Low Ref./Feedb. Value	0.000 N/A	All set-ups	TRUE	-3	Int32
6-45	Term. X30/12 High Ref./Feedb. Value	100.000 N/A	All set-ups	TRUE	-3	Int32
6-46	Term. X30/12 Filter Time Constant	0.001 s	All set-ups	TRUE	-3	Uint16
6-47	Term. X30/12 Live Zero	[1] Enabled	All set-ups	TRUE	-	Uint8
<b>6-5* Analog Output 42</b>						
6-50	Terminal 42 Output	[100] Output freq. 0-100	All set-ups	TRUE	-	Uint8
6-51	Terminal 42 Output Min Scale	0.00 %	All set-ups	TRUE	-2	Int16
6-52	Terminal 42 Output Max Scale	100.00 %	All set-ups	TRUE	-2	Int16
6-53	Terminal 42 Output Bus Control	0.00 %	All set-ups	TRUE	-2	N2
6-54	Terminal 42 Output Timeout Preset	0.00 %	1 set-up	TRUE	-2	Uint16
<b>6-6* Analog Output X30/8</b>						
6-60	Terminal X30/8 Output	[0] No operation	All set-ups	TRUE	-	Uint8
6-61	Terminal X30/8 Min. Scale	0.00 %	All set-ups	TRUE	-2	Int16
6-62	Terminal X30/8 Max. Scale	100.00 %	All set-ups	TRUE	-2	Int16
6-63	Terminal X30/8 Output Bus Control	0.00 %	All set-ups	TRUE	-2	N2
6-64	Terminal X30/8 Output Timeout Preset	0.00 %	1 set-up	TRUE	-2	Uint16

### 3.1.9 Comm. and Options 8-\*\*

Par. No. #	Parameter description	Default value	4-set-up	Change during operation	Conversion index	Type
<b>8-0* General Settings</b>						
8-01	Control Site	null	All set-ups	TRUE	-	Uint8
8-02	Control Source	null	All set-ups	TRUE	-	Uint8
8-03	Control Timeout Time	SR	1 set-up	TRUE	-1	Uint32
8-04	Control Timeout Function	[0] Off	1 set-up	TRUE	-	Uint8
8-05	End-of-Timeout Function	[1] Resume set-up	1 set-up	TRUE	-	Uint8
8-06	Reset Control Timeout	[0] Do not reset	All set-ups	TRUE	-	Uint8
8-07	Diagnosis Trigger	[0] Disable	2 set-ups	TRUE	-	Uint8
<b>8-1* Control Settings</b>						
8-10	Control Profile	[0] FC profile	All set-ups	TRUE	-	Uint8
8-13	Configurable Status Word STW	[1] Profile Default	All set-ups	TRUE	-	Uint8
8-14	Configurable Control Word CTW	[1] Profile default	All set-ups	TRUE	-	Uint8
<b>8-3* FC Port Settings</b>						
8-30	Protocol	null	1 set-up	TRUE	-	Uint8
8-31	Address	SR	1 set-up	TRUE	0	Uint8
8-32	Baud Rate	null	1 set-up	TRUE	-	Uint8
8-33	Parity / Stop Bits	null	1 set-up	TRUE	-	Uint8
8-35	Minimum Response Delay	SR	1 set-up	TRUE	-3	Uint16
8-36	Max Response Delay	SR	1 set-up	TRUE	-3	Uint16
8-37	Maximum Inter-Char Delay	SR	1 set-up	TRUE	-5	Uint16
<b>8-4* FC MC protocol set</b>						
8-40	Telegram Selection	[1] Standard telegram 1	2 set-ups	TRUE	-	Uint8
<b>8-5* Digital/Bus</b>						
8-50	Coasting Select	[3] Logic OR	All set-ups	TRUE	-	Uint8
8-52	DC Brake Select	[3] Logic OR	All set-ups	TRUE	-	Uint8
8-53	Start Select	[3] Logic OR	All set-ups	TRUE	-	Uint8
8-54	Reversing Select	null	All set-ups	TRUE	-	Uint8
8-55	Set-up Select	[3] Logic OR	All set-ups	TRUE	-	Uint8
8-56	Preset Reference Select	[3] Logic OR	All set-ups	TRUE	-	Uint8
<b>8-7* BA Cnet</b>						
8-70	BACnet Device Instance	1 N/A	1 set-up	TRUE	0	Uint32
8-72	MS/TP Max Masters	127 N/A	1 set-up	TRUE	0	Uint8
8-73	MS/TP Max Info Frames	1 N/A	1 set-up	TRUE	0	Uint16
8-74	"I-Aim" Service	[0] Send at power-up	1 set-up	TRUE	-	Uint8
8-75	Initialisation Password	SR	1 set-up	TRUE	0	VisStr[20]
<b>8-8* FC Port Diagnostics</b>						
8-80	Bus Message Count	0 N/A	All set-ups	TRUE	0	Uint32
8-81	Bus Error Count	0 N/A	All set-ups	TRUE	0	Uint32
8-82	Slave Message Rcvd	0 N/A	All set-ups	TRUE	0	Uint32
8-83	Slave Error Count	0 N/A	All set-ups	TRUE	0	Uint32
<b>8-9* Bus Jog / Feedback</b>						
8-90	Bus Jog 1 Speed	100 RPM	All set-ups	TRUE	67	Uint16
8-91	Bus Jog 2 Speed	200 RPM	All set-ups	TRUE	67	Uint16
8-94	Bus Feedback 1	0 N/A	1 set-up	TRUE	0	N2
8-95	Bus Feedback 2	0 N/A	1 set-up	TRUE	0	N2
8-96	Bus Feedback 3	0 N/A	1 set-up	TRUE	0	N2

# 3



### 3.1.10 Profibus 9-\*\*-\*

Par. No. #	Parameter description	Default value	4-set-up	Change during operation	Conversion index	Type
<b>8-0* General Settings</b>						
8-01	Control Site	null	All set-ups	TRUE	-	UInt8
8-02	Control Source	null	All set-ups	TRUE	-	UInt8
8-03	Control Timeout Time	SR	1 set-up	TRUE	-1	UInt32
8-04	Control Timeout Function	[0] Off	1 set-up	TRUE	-	UInt8
8-05	End-of-Timeout Function	[1] Resume set-up	1 set-up	TRUE	-	UInt8
8-06	Reset Control Timeout	[0] Do not reset	All set-ups	TRUE	-	UInt8
8-07	Diagnosis Trigger	[0] Disable	2 set-ups	TRUE	-	UInt8
<b>8-1* Control Settings</b>						
8-10	Control Profile	[0] FC profile	All set-ups	TRUE	-	UInt8
8-13	Configurable Status Word STW	[1] Profile Default	All set-ups	TRUE	-	UInt8
8-14	Configurable Control Word CTW	[1] Profile default	All set-ups	TRUE	-	UInt8
<b>8-3* FC Port Settings</b>						
8-30	Protocol	null	1 set-up	TRUE	-	UInt8
8-31	Address	SR	1 set-up	TRUE	0	UInt8
8-32	Baud Rate	null	1 set-up	TRUE	-	UInt8
8-33	Parity / Stop Bits	null	1 set-up	TRUE	-	UInt8
8-35	Minimum Response Delay	SR	1 set-up	TRUE	-3	UInt16
8-36	Max Response Delay	SR	1 set-up	TRUE	-3	UInt16
8-37	Maximum Inter-Char Delay	SR	1 set-up	TRUE	-5	UInt16
<b>8-4* FC MC protocol set</b>						
8-40	Telegram Selection	[1] Standard telegram 1	2 set-ups	TRUE	-	UInt8
<b>8-5* Digital/Bus</b>						
8-50	Coasting Select	[3] Logic OR	All set-ups	TRUE	-	UInt8
8-52	DC Brake Select	[3] Logic OR	All set-ups	TRUE	-	UInt8
8-53	Start Select	[3] Logic OR	All set-ups	TRUE	-	UInt8
8-54	Reversing Select	null	All set-ups	TRUE	-	UInt8
8-55	Set-up Select	[3] Logic OR	All set-ups	TRUE	-	UInt8
8-56	Preset Reference Select	[3] Logic OR	All set-ups	TRUE	-	UInt8
<b>8-7* BACnet</b>						
8-70	BACnet Device Instance	1 N/A	1 set-up	TRUE	0	UInt32
8-72	MS/TP Max Masters	127 N/A	1 set-up	TRUE	0	UInt8
8-73	MS/TP Max Info Frames	1 N/A	1 set-up	TRUE	0	UInt16
8-74	"I-Am" Service	[0] Send at power-up	1 set-up	TRUE	-	UInt8
8-75	Initialisation Password	SR	1 set-up	TRUE	0	VisStr[20]
<b>8-8* FC Port Diagnostics</b>						
8-80	Bus Message Count	0 N/A	All set-ups	TRUE	0	UInt32
8-81	Bus Error Count	0 N/A	All set-ups	TRUE	0	UInt32
8-82	Slave Message Rcvd	0 N/A	All set-ups	TRUE	0	UInt32
8-83	Slave Error Count	0 N/A	All set-ups	TRUE	0	UInt32
<b>8-9* Bus Jog / Feedback</b>						
8-90	Bus Jog 1 Speed	100 RPM	All set-ups	TRUE	67	UInt16
8-91	Bus Jog 2 Speed	200 RPM	All set-ups	TRUE	67	UInt16
8-94	Bus Feedback 1	0 N/A	1 set-up	TRUE	0	N2
8-95	Bus Feedback 2	0 N/A	1 set-up	TRUE	0	N2
8-96	Bus Feedback 3	0 N/A	1 set-up	TRUE	0	N2

### 3.1.1.11 CAN Fieldbus 10-\*\*

Par. No. #	Parameter description	Default value	4-set-up	Change during operation	Conversion index	Type
<b>10-0* Common Settings</b>						
10-00	CAN Protocol	null	2 set-ups	FALSE	-	Uint8
10-01	Baud Rate Select	null	2 set-ups	TRUE	-	Uint8
10-02	MAC ID	SR	2 set-ups	TRUE	0	Uint8
10-05	Readout Transmit Error Counter	0 N/A	All set-ups	TRUE	0	Uint8
10-06	Readout Receive Error Counter	0 N/A	All set-ups	TRUE	0	Uint8
10-07	Readout Bus Off Counter	0 N/A	All set-ups	TRUE	0	Uint8
<b>10-1* DeviceNet</b>						
10-10	Process Data Type Selection	null	All set-ups	TRUE	-	Uint8
10-11	Process Data Config Write	SR	2 set-ups	TRUE	-	Uint16
10-12	Process Data Config Read	SR	2 set-ups	TRUE	-	Uint16
10-13	Warning Parameter	0 N/A	All set-ups	TRUE	0	Uint16
10-14	Net Reference	[0] Off	2 set-ups	TRUE	-	Uint8
10-15	Net Control	[0] Off	2 set-ups	TRUE	-	Uint8
<b>10-2* COS Filters</b>						
10-20	COS Filter 1	0 N/A	All set-ups	FALSE	0	Uint16
10-21	COS Filter 2	0 N/A	All set-ups	FALSE	0	Uint16
10-22	COS Filter 3	0 N/A	All set-ups	FALSE	0	Uint16
10-23	COS Filter 4	0 N/A	All set-ups	FALSE	0	Uint16
<b>10-3* Parameter Access</b>						
10-30	Array Index	0 N/A	2 set-ups	TRUE	0	Uint8
10-31	Store Data Values	[0] Off	All set-ups	TRUE	-	Uint8
10-32	DeviceNet Revision	SR	All set-ups	TRUE	0	Uint16
10-33	Store Always	[0] Off	1 set-up	TRUE	-	Uint8
10-34	DeviceNet Product Code	130 N/A	1 set-up	TRUE	0	Uint16
10-39	DeviceNet F Parameters	0 N/A	All set-ups	TRUE	0	Uint32

**3.1.12 Smart Logic 13-\*\***

Par. No. #	Parameter description	Default value	4-set-up	Change during operation	Conversion index	Type
<b>13-0* SLC Settings</b>						
13-00	SL Controller Mode	null	2 set-ups	TRUE	-	UInt8
13-01	Start Event	null	2 set-ups	TRUE	-	UInt8
13-02	Stop Event	null	2 set-ups	TRUE	-	UInt8
13-03	Reset SLC	[0] Do not reset SLC	All set-ups	TRUE	-	UInt8
<b>13-1* Comparators</b>						
13-10	Comparator Operand	null	2 set-ups	TRUE	-	UInt8
13-11	Comparator Operator	null	2 set-ups	TRUE	-	UInt8
13-12	Comparator Value	SR	2 set-ups	TRUE	-3	Int32
<b>13-2* Timers</b>						
13-20	SL Controller Timer	SR	1 set-up	TRUE	-3	TimD
<b>13-4* Logic Rules</b>						
13-40	Logic Rule Boolean 1	null	2 set-ups	TRUE	-	UInt8
13-41	Logic Rule Operator 1	null	2 set-ups	TRUE	-	UInt8
13-42	Logic Rule Boolean 2	null	2 set-ups	TRUE	-	UInt8
13-43	Logic Rule Operator 2	null	2 set-ups	TRUE	-	UInt8
13-44	Logic Rule Boolean 3	null	2 set-ups	TRUE	-	UInt8
<b>13-5* States</b>						
13-51	SL Controller Event	null	2 set-ups	TRUE	-	UInt8
13-52	SL Controller Action	null	2 set-ups	TRUE	-	UInt8

### 3.1.13 Special Functions 14-\*\*-\*

Par. No. #	Parameter description	Default value	4-set-up	Change during operation	Conversion index	Type
<b>14-0* Inverter Switching</b>						
14-00	Switching Pattern	null	All set-ups	TRUE	-	Uint8
14-01	Switching Frequency	null	All set-ups	TRUE	-	Uint8
14-03	Overmodulation	[1] On	All set-ups	FALSE	-	Uint8
14-04	PWM Random	[0] Off	All set-ups	TRUE	-	Uint8
<b>14-1* Mains On / Off</b>						
14-10	Mains Failure	[0] No function	All set-ups	FALSE	-	Uint8
14-11	Mains Voltage at Mains Fault	SR	All set-ups	TRUE	0	Uint16
14-12	Function at Mains Imbalance	[3] Derate	All set-ups	TRUE	-	Uint8
<b>14-2* Reset Functions</b>						
14-20	Reset Mode	[10] Automatic reset x 10	All set-ups	TRUE	-	Uint8
14-21	Automatic Restart Time	10 s	All set-ups	TRUE	0	Uint16
14-22	Operation Mode	[0] Normal operation	All set-ups	TRUE	-	Uint8
14-23	Typecode Setting	null	2 set-ups	FALSE	-	Uint8
14-25	Trip Delay at Torque Limit	60 s	All set-ups	TRUE	0	Uint8
14-26	Trip Delay at Inverter Fault	SR	All set-ups	TRUE	0	Uint8
14-28	Production Settings	[0] No action	All set-ups	TRUE	-	Uint8
14-29	Service Code	0 N/A	All set-ups	TRUE	0	Int32
<b>14-3* Current Limit Ctrl.</b>						
14-30	Current Lim Ctrl, Proportional Gain	100 %	All set-ups	FALSE	0	Uint16
14-31	Current Lim Ctrl, Integration Time	0.020 s	All set-ups	FALSE	-3	Uint16
14-32	Current Lim Ctrl, Filter Time	27.0 ms	All set-ups	FALSE	-4	Uint16
<b>14-4* Energy Optimising</b>						
14-40	VT Level	66 %	All set-ups	FALSE	0	Uint8
14-41	AEO Minimum Magnetisation	SR	All set-ups	TRUE	0	Uint8
14-42	Minimum AEO Frequency	10 Hz	All set-ups	TRUE	0	Uint8
14-43	Motor Cosphi	SR	All set-ups	TRUE	-2	Uint16
<b>14-5* Environment</b>						
14-50	RFI Filter	[1] On	1 set-up	FALSE	-	Uint8
14-52	Fan Control	[0] Auto	All set-ups	TRUE	-	Uint8
14-53	Fan Monitor	[1] Warning	All set-ups	TRUE	-	Uint8
14-55	Output Filter	[0] No Filter	1 set-up	FALSE	-	Uint8
14-59	Actual Number of Inverter Units	SR	1 set-up	FALSE	0	Uint8
<b>14-6* Auto Derate</b>						
14-60	Function at Over Temperature	[1] Derate	All set-ups	TRUE	-	Uint8
14-61	Function at Inverter Overload	[1] Derate	All set-ups	TRUE	-	Uint8
14-62	Inv. Overload Derate Current	95 %	All set-ups	TRUE	0	Uint16
<b>14-8* Options</b>						
14-80	Option Supplied by External 24VDC	[0] No	2 set-ups	FALSE	-	Uint8

**3.1.14 FC Information 15-\*\*-\***

Par. No. #	Parameter description	Default value	4-set-up	Change during operation	Conversion index	Type
<b>15-0* Operating Data</b>						
15-00	Operating Hours	0 h	All set-ups	FALSE	74	Uint32
15-01	Running Hours	0 h	All set-ups	FALSE	74	Uint32
15-02	kWh Counter	0 kWh	All set-ups	FALSE	75	Uint32
15-03	Power Up's	0 N/A	All set-ups	FALSE	0	Uint32
15-04	Over Temp's	0 N/A	All set-ups	FALSE	0	Uint16
15-05	Over Volt's	0 N/A	All set-ups	FALSE	0	Uint16
15-06	Reset kWh Counter	[0] Do not reset	All set-ups	TRUE	-	Uint8
15-07	Reset Running Hours Counter	[0] Do not reset	All set-ups	TRUE	-	Uint8
15-08	Number of Starts	0 N/A	All set-ups	FALSE	0	Uint32
<b>15-1* Data Log Settings</b>						
15-10	Logging Source	0	2 set-ups	TRUE	-	Uint16
15-11	Logging Interval	SR	2 set-ups	TRUE	-3	TimD
15-12	Trigger Event	[0] False	1 set-up	TRUE	-	Uint8
15-13	Logging Mode	[0] Log always	2 set-ups	TRUE	-	Uint8
15-14	Samples Before Trigger	50 N/A	2 set-ups	TRUE	0	Uint8
<b>15-2* Historic Log</b>						
15-20	Historic Log: Event	0 N/A	All set-ups	FALSE	0	Uint8
15-21	Historic Log: Value	0 N/A	All set-ups	FALSE	0	Uint32
15-22	Historic Log: Time	0 ms	All set-ups	FALSE	-3	Uint32
15-23	Historic Log: Date and Time	SR	All set-ups	FALSE	0	TimeOfDay
<b>15-3* Alarm Log</b>						
15-30	Alarm Log: Error Code	0 N/A	All set-ups	FALSE	0	Uint16
15-31	Alarm Log: Value	0 N/A	All set-ups	FALSE	0	Int16
15-32	Alarm Log: Time	0 s	All set-ups	FALSE	0	Uint32
15-33	Alarm Log: Date and Time	SR	All set-ups	FALSE	0	TimeOfDay
15-34	Alarm Log: Setpoint	0.000 ProcessCtrlUnit	All set-ups	FALSE	-3	Int32
15-35	Alarm Log: Feedback	0.000 ProcessCtrlUnit	All set-ups	FALSE	-3	Int32
15-36	Alarm Log: Current Demand	0 %	All set-ups	FALSE	0	Uint8
15-37	Alarm Log: Process Ctrl Unit	[0]	All set-ups	FALSE	-	Uint8
<b>15-4* Drive Identification</b>						
15-40	FC Type	0 N/A	All set-ups	FALSE	0	VisStr[6]
15-41	Power Section	0 N/A	All set-ups	FALSE	0	VisStr[20]
15-42	Voltage	0 N/A	All set-ups	FALSE	0	VisStr[20]
15-43	Software Version	0 N/A	All set-ups	FALSE	0	VisStr[5]
15-44	Ordered Typecode String	0 N/A	All set-ups	FALSE	0	VisStr[40]
15-45	Actual Typecode String	0 N/A	All set-ups	FALSE	0	VisStr[40]
15-46	Frequency Converter Ordering No	0 N/A	All set-ups	FALSE	0	VisStr[8]
15-47	Power Card Ordering No	0 N/A	All set-ups	FALSE	0	VisStr[8]
15-48	LCP Id No	0 N/A	All set-ups	FALSE	0	VisStr[20]
15-49	SW ID Control Card	0 N/A	All set-ups	FALSE	0	VisStr[20]
15-50	SW ID Power Card	0 N/A	All set-ups	FALSE	0	VisStr[20]
15-51	Frequency Converter Serial Number	0 N/A	All set-ups	FALSE	0	VisStr[10]
15-53	Power Card Serial Number	0 N/A	All set-ups	FALSE	0	VisStr[19]

Par. No. #	Parameter description	Default value	4-set-up	Change during operation	Conversion index	Type
<b>15-6* Option Ident</b>						
15-60	Option Mounted	0 N/A	All set-ups	FALSE	0	VisStr[30]
15-61	Option SW Version	0 N/A	All set-ups	FALSE	0	VisStr[20]
15-62	Option Ordering No	0 N/A	All set-ups	FALSE	0	VisStr[8]
15-63	Option Serial No	0 N/A	All set-ups	FALSE	0	VisStr[18]
15-70	Option in Slot A	0 N/A	All set-ups	FALSE	0	VisStr[30]
15-71	Slot A Option SW Version	0 N/A	All set-ups	FALSE	0	VisStr[20]
15-72	Option in Slot B	0 N/A	All set-ups	FALSE	0	VisStr[30]
15-73	Slot B Option SW Version	0 N/A	All set-ups	FALSE	0	VisStr[20]
15-74	Option in Slot C0	0 N/A	All set-ups	FALSE	0	VisStr[30]
15-75	Slot C0 Option SW Version	0 N/A	All set-ups	FALSE	0	VisStr[20]
15-76	Option in Slot C1	0 N/A	All set-ups	FALSE	0	VisStr[30]
15-77	Slot C1 Option SW Version	0 N/A	All set-ups	FALSE	0	VisStr[20]
<b>15-9* Parameter Info</b>						
15-92	Defined Parameters	0 N/A	All set-ups	FALSE	0	Uint16
15-93	Modified Parameters	0 N/A	All set-ups	FALSE	0	Uint16
15-98	Drive Identification	0 N/A	All set-ups	FALSE	0	VisStr[40]
15-99	Parameter Metadata	0 N/A	All set-ups	FALSE	0	Uint16

### 3.1.15 Data Readouts 16-\*\*-\*

Par. No. #	Parameter description	Default value	4-set-up	Change during operation	Conversion index	Type
<b>16-0* General Status</b>						
16-00	Control Word	0 N/A	All set-ups	TRUE	0	V2
16-01	Reference [Unit]	0.000 ReferenceFeedbackUnit	All set-ups	TRUE	-3	Int32
16-02	Reference [%]	0.0 %	All set-ups	TRUE	-1	Int16
16-03	Status Word	0 N/A	All set-ups	TRUE	0	V2
16-05	Main Actual Value [%]	0.00 %	All set-ups	TRUE	-2	N2
16-09	Custom Readout	0.00 CustomReadoutUnit	All set-ups	TRUE	-2	Int32
<b>16-1* Motor Status</b>						
16-10	Power [kW]	0.00 kW	All set-ups	TRUE	1	Int32
16-11	Power [hp]	0.00 hp	All set-ups	TRUE	-2	Int32
16-12	Motor Voltage	0.0 V	All set-ups	TRUE	-1	Uint16
16-13	Frequency	0.0 Hz	All set-ups	TRUE	-1	Uint16
16-14	Motor Current	0.00 A	All set-ups	TRUE	-2	Int32
16-15	Frequency [%]	0.00 %	All set-ups	TRUE	-2	N2
16-16	Torque [Nm]	0.0 Nm	All set-ups	TRUE	-1	Int32
16-17	Speed [RPM]	0 RPM	All set-ups	TRUE	67	Int32
16-18	Motor Thermal	0 %	All set-ups	TRUE	0	Uint8
16-22	Torque [%]	0 %	All set-ups	TRUE	0	Int16
<b>16-3* Drive Status</b>						
16-30	DC Link Voltage	0 V	All set-ups	TRUE	0	Uint16
16-32	Brake Energy /s	0.000 kW	All set-ups	TRUE	0	Int32
16-33	Brake Energy /2 min	0.000 kW	All set-ups	TRUE	0	Int32
16-34	Heatsink Temp.	0 °C	All set-ups	TRUE	100	Uint8
16-35	Inverter Thermal	0 %	All set-ups	TRUE	0	Uint8
16-36	Inv. Nom. Current	SR	All set-ups	TRUE	-2	Int32
16-37	Inv. Max. Current	SR	All set-ups	TRUE	-2	Int32
16-38	SL Controller State	0 N/A	All set-ups	TRUE	0	Uint8
16-39	Control Card Temp.	0 °C	All set-ups	TRUE	100	Uint8
16-40	Logging Buffer Full	[0] No	All set-ups	TRUE	-	Uint8
<b>16-5* Ref. &amp; Feedb.</b>						
16-50	External Reference	0.0 N/A	All set-ups	TRUE	-1	Int16
16-52	Feedback [Unit]	0.000 ProcessCtrlUnit	All set-ups	TRUE	-3	Int32
16-53	Digi Pot Reference	0.00 N/A	All set-ups	TRUE	-2	Int16
16-54	Feedback 1 [Unit]	0.000 ProcessCtrlUnit	All set-ups	TRUE	-3	Int32
16-55	Feedback 2 [Unit]	0.000 ProcessCtrlUnit	All set-ups	TRUE	-3	Int32
16-56	Feedback 3 [Unit]	0.000 ProcessCtrlUnit	All set-ups	TRUE	-3	Int32
16-58	PID Output [%]	0.0 %	All set-ups	TRUE	-1	Int32
16-59	Adjusted Setpoint	0.000 ProcessCtrlUnit	All set-ups	TRUE	-3	Int32

Par. No. #	Parameter description	Default value	4-set-up	Change during operation	Conversion index	Type
<b>16-6* Inputs &amp; Outputs</b>						
16-60	Digital Input	0 N/A	All set-ups	TRUE	0	UInt16
16-61	Terminal 53 Switch Setting	[0] Current	All set-ups	TRUE	-	UInt8
16-62	Analog Input 53	0.000 N/A	All set-ups	TRUE	-3	Int32
16-63	Terminal 54 Switch Setting	[0] Current	All set-ups	TRUE	-	UInt8
16-64	Analog Input 54	0.000 N/A	All set-ups	TRUE	-3	Int32
16-65	Analog Output 42 [mA]	0.000 N/A	All set-ups	TRUE	-3	Int16
16-66	Digital Output [bin]	0 N/A	All set-ups	TRUE	0	Int16
16-67	Pulse Input #29 [Hz]	0 N/A	All set-ups	TRUE	0	Int32
16-68	Pulse Input #33 [Hz]	0 N/A	All set-ups	TRUE	0	Int32
16-69	Pulse Output #27 [Hz]	0 N/A	All set-ups	TRUE	0	Int32
16-70	Pulse Output #29 [Hz]	0 N/A	All set-ups	TRUE	0	Int32
16-71	Relay Output [bin]	0 N/A	All set-ups	TRUE	0	Int16
16-72	Counter A	0 N/A	All set-ups	TRUE	0	Int32
16-73	Counter B	0 N/A	All set-ups	TRUE	0	Int32
16-75	Analog In X30/11	0.000 N/A	All set-ups	TRUE	-3	Int32
16-76	Analog In X30/12	0.000 N/A	All set-ups	TRUE	-3	Int32
16-77	Analog Out X30/8 [mA]	0.000 N/A	All set-ups	TRUE	-3	Int16
<b>16-8* Fieldbus &amp; FC Port</b>						
16-80	Fieldbus CTW 1	0 N/A	All set-ups	TRUE	0	V2
16-82	Fieldbus REF 1	0 N/A	All set-ups	TRUE	0	N2
16-84	Comm. Option STW	0 N/A	All set-ups	TRUE	0	V2
16-85	FC Port CTW 1	0 N/A	All set-ups	TRUE	0	V2
16-86	FC Port REF 1	0 N/A	All set-ups	TRUE	0	N2
<b>16-9* Diagnosis Readouts</b>						
16-90	Alarm Word	0 N/A	All set-ups	TRUE	0	UInt32
16-91	Alarm Word 2	0 N/A	All set-ups	TRUE	0	UInt32
16-92	Warning Word	0 N/A	All set-ups	TRUE	0	UInt32
16-93	Warning Word 2	0 N/A	All set-ups	TRUE	0	UInt32
16-94	Ext. Status Word	0 N/A	All set-ups	TRUE	0	UInt32
16-95	Ext. Status Word 2	0 N/A	All set-ups	TRUE	0	UInt32
16-96	Maintenance Word	0 N/A	All set-ups	TRUE	0	UInt32

### 3.1.16 Data Readouts 2 18-\*\*

Par. No. #	Parameter description	Default value	4-set-up	Change during operation	Conversion index	Type
<b>18-0* Maintenance Log</b>						
18-00	Maintenance Log: Item	0 N/A	All set-ups	FALSE	0	UInt8
18-01	Maintenance Log: Action	0 N/A	All set-ups	FALSE	0	UInt8
18-02	Maintenance Log: Time	0 s	All set-ups	FALSE	0	UInt32
18-03	Maintenance Log: Date and Time	SR	All set-ups	FALSE	0	TimeOfDay
<b>18-3* Inputs &amp; Outputs</b>						
18-30	Analog Input X42/1	0.000 N/A	All set-ups	FALSE	-3	Int32
18-31	Analog Input X42/3	0.000 N/A	All set-ups	FALSE	-3	Int32
18-32	Analog Input X42/5	0.000 N/A	All set-ups	FALSE	-3	Int32
18-33	Analog Out X42/7 [V]	0.000 N/A	All set-ups	FALSE	-3	Int16
18-34	Analog Out X42/9 [V]	0.000 N/A	All set-ups	FALSE	-3	Int16
18-35	Analog Out X42/11 [V]	0.000 N/A	All set-ups	FALSE	-3	Int16

**3.1.17 FC Closed Loop 20-\*\*-\***

Par. No. #	Parameter description	Default value	4-set-up	Change during operation	Conversion index	Type
<b>20-0* Feedback</b>						
20-00	Feedback 1 Source	[2] Analog input 54	All set-ups	TRUE	-	Uint8
20-01	Feedback 1 Conversion	[0] Linear	All set-ups	FALSE	-	Uint8
20-02	Feedback 1 Source Unit	null	All set-ups	TRUE	-	Uint8
20-03	Feedback 2 Source	[0] No function	All set-ups	TRUE	-	Uint8
20-04	Feedback 2 Conversion	[0] Linear	All set-ups	FALSE	-	Uint8
20-05	Feedback 2 Source Unit	null	All set-ups	TRUE	-	Uint8
20-06	Feedback 3 Source	[0] No function	All set-ups	TRUE	-	Uint8
20-07	Feedback 3 Conversion	[0] Linear	All set-ups	FALSE	-	Uint8
20-08	Feedback 3 Source Unit	null	All set-ups	TRUE	-	Uint8
20-12	Reference/Feedback Unit	null	All set-ups	TRUE	-	Uint8
<b>20-2* Feedback/Setpoint</b>						
20-20	Feedback Function	[4] Maximum	All set-ups	TRUE	-	Uint8
20-21	Setpoint 1	0.000 ProcessCtrlUnit	All set-ups	TRUE	-3	Int32
20-22	Setpoint 2	0.000 ProcessCtrlUnit	All set-ups	TRUE	-3	Int32
20-23	Setpoint 3	0.000 ProcessCtrlUnit	All set-ups	TRUE	-3	Int32
<b>20-7* PID Autotuning</b>						
20-70	Closed Loop Type	[0] Auto	2 set-ups	TRUE	-	Uint8
20-71	PID Performance	[0] Normal	2 set-ups	TRUE	-	Uint8
20-72	PID Output Change	0.10 N/A	2 set-ups	TRUE	-2	Uint16
20-73	Minimum Feedback Level	-999999.000 ProcessCtrlUnit	2 set-ups	TRUE	-3	Int32
20-74	Maximum Feedback Level	999999.000 ProcessCtrlUnit	2 set-ups	TRUE	-3	Int32
20-79	PID Autotuning	[0] Disabled	All set-ups	TRUE	-	Uint8
<b>20-8* PID Basic Settings</b>						
20-81	PID Normal/ Inverse Control	[0] Normal	All set-ups	TRUE	-	Uint8
20-82	PID Start Speed [RPM]	SR	All set-ups	TRUE	67	Uint16
20-83	PID Start Speed [Hz]	SR	All set-ups	TRUE	-1	Uint16
20-84	On Reference Bandwidth	5 %	All set-ups	TRUE	0	Uint8
<b>20-9* PID Controller</b>						
20-91	PID Anti Windup	[1] On	All set-ups	TRUE	-	Uint8
20-93	PID Proportional Gain	2.00 N/A	All set-ups	TRUE	-2	Uint16
20-94	PID Integral Time	8.00 s	All set-ups	TRUE	-2	Uint32
20-95	PID Differentiation Time	0.00 s	All set-ups	TRUE	-2	Uint16
20-96	PID Diff. Gain Limit	5.0 N/A	All set-ups	TRUE	-1	Uint16

**3.1.18 Ext. Closed Loop 21-\*\***

Par. No. #	Parameter description	Default value	4-set-up	Change during operation	Conversion index	Type
<b>21-0* Ext. CL Autotuning</b>						
21-00	Closed Loop Type	[0] Auto	2 set-ups	TRUE	-	Uint8
21-01	PID Performance	[0] Normal	2 set-ups	TRUE	-	Uint8
21-02	PID Output Change	0.10 N/A	2 set-ups	TRUE	-2	Uint16
21-03	Minimum Feedback Level	-999999,000 N/A	2 set-ups	TRUE	-3	Int32
21-04	Maximum Feedback Level	999999,000 N/A	2 set-ups	TRUE	-3	Int32
21-09	PID Auto Tuning	[0] Disabled	All set-ups	TRUE	-	Uint8
<b>21-1* Ext. CL 1 Ref./Fb.</b>						
21-10	Ext. 1 Ref./Feedback Unit	[0]	All set-ups	TRUE	-	Uint8
21-11	Ext. 1 Minimum Reference	0.000 ExtPID1Unit	All set-ups	TRUE	-3	Int32
21-12	Ext. 1 Maximum Reference	100,000 ExpPID1Unit	All set-ups	TRUE	-3	Int32
21-13	Ext. 1 Reference Source	[0] No function	All set-ups	TRUE	-	Uint8
21-14	Ext. 1 Feedback Source	[0] No function	All set-ups	TRUE	-	Uint8
21-15	Ext. 1 Setpoint	0.000 ExtPID1Unit	All set-ups	TRUE	-3	Int32
21-17	Ext. 1 Reference [Unit]	0.000 ExpPID1Unit	All set-ups	TRUE	-3	Int32
21-18	Ext. 1 Feedback [Unit]	0.000 ExpPID1Unit	All set-ups	TRUE	-3	Int32
21-19	Ext. 1 Output [%]	0 %	All set-ups	TRUE	0	Int32
<b>21-2* Ext. CL 1 PID</b>						
21-20	Ext. 1 Normal/Inverse Control	[0] Normal	All set-ups	TRUE	-	Uint8
21-21	Ext. 1 Proportional Gain	0.50 N/A	All set-ups	TRUE	-2	Uint16
21-22	Ext. 1 Integral Time	20,00 s	All set-ups	TRUE	-2	Uint32
21-23	Ext. 1 Differentiation Time	0.00 s	All set-ups	TRUE	-2	Uint16
21-24	Ext. 1 Dif. Gain Limit	5.0 N/A	All set-ups	TRUE	-1	Uint16
<b>21-3* Ext. CL 2 Ref./Fb.</b>						
21-30	Ext. 2 Ref./Feedback Unit	[0]	All set-ups	TRUE	-	Uint8
21-31	Ext. 2 Minimum Reference	0.000 ExpPID2Unit	All set-ups	TRUE	-3	Int32
21-32	Ext. 2 Maximum Reference	100,000 ExpPID2Unit	All set-ups	TRUE	-3	Int32
21-33	Ext. 2 Reference Source	[0] No function	All set-ups	TRUE	-	Uint8
21-34	Ext. 2 Feedback Source	[0] No function	All set-ups	TRUE	-	Uint8
21-35	Ext. 2 Setpoint	0.000 ExpPID2Unit	All set-ups	TRUE	-3	Int32
21-37	Ext. 2 Reference [Unit]	0.000 ExpPID2Unit	All set-ups	TRUE	-3	Int32
21-38	Ext. 2 Feedback [Unit]	0.000 ExpPID2Unit	All set-ups	TRUE	-3	Int32
21-39	Ext. 2 Output [%]	0 %	All set-ups	TRUE	0	Int32
<b>21-4* Ext. CL 2 PID</b>						
21-40	Ext. 2 Normal/Inverse Control	[0] Normal	All set-ups	TRUE	-	Uint8
21-41	Ext. 2 Proportional Gain	0.50 N/A	All set-ups	TRUE	-2	Uint16
21-42	Ext. 2 Integral Time	20,00 s	All set-ups	TRUE	-2	Uint32
21-43	Ext. 2 Differentiation Time	0.00 s	All set-ups	TRUE	-2	Uint16
21-44	Ext. 2 Dif. Gain Limit	5.0 N/A	All set-ups	TRUE	-1	Uint16

Par. No. #	Parameter description	Default value	4-set-up	Change during operation	Conversion index	Type
<b>21-5*</b>	<b>Ext. CL 3 Ref./Fb.</b>					
21-50	Ext. 3 Ref./Feedback Unit	[0]	All set-ups	TRUE	-	Uint8
21-51	Ext. 3 Minimum Reference	0.000 ExtPID3Unit	All set-ups	TRUE	-3	Int32
21-52	Ext. 3 Maximum Reference	100.000 ExtPID3Unit	All set-ups	TRUE	-3	Int32
21-53	Ext. 3 Reference Source	[0] No function	All set-ups	TRUE	-	Uint8
21-54	Ext. 3 Feedback Source	[0] No function	All set-ups	TRUE	-	Uint8
21-55	Ext. 3 Setpoint	0.000 ExtPID3Unit	All set-ups	TRUE	-3	Int32
21-57	Ext. 3 Reference [Unit]	0.000 ExtPID3Unit	All set-ups	TRUE	-3	Int32
21-58	Ext. 3 Feedback [Unit]	0.000 ExtPID3Unit	All set-ups	TRUE	-3	Int32
21-59	Ext. 3 Output [%]	0 %	All set-ups	TRUE	0	Int32
<b>21-6*</b>	<b>Ext. CL 3 PID</b>					
21-60	Ext. 3 Normal/Inverse Control	[0] Normal	All set-ups	TRUE	-	Uint8
21-61	Ext. 3 Proportional Gain	0.50 N/A	All set-ups	TRUE	-2	Uint16
21-62	Ext. 3 Integral Time	20.00 s	All set-ups	TRUE	-2	Uint32
21-63	Ext. 3 Differentiation Time	0.00 s	All set-ups	TRUE	-2	Uint16
21-64	Ext. 3 Dif. Gain Limit	5.0 N/A	All set-ups	TRUE	-1	Uint16

3

3.1.19 Application Functions 22-\*\*

Par. No. #	Parameter description	Default value	4-set-up	Change during operation	Conversion index	Type
<b>22-0* Miscellaneous</b>						
22-00	External Interlock Delay	0 s	All set-ups	TRUE	0	Uint16
<b>22-2* No-Flow Detection</b>						
22-20	Low Power Auto Set-up	[0] Off	All set-ups	FALSE	-	Uint8
22-21	Low Power Detection	[0] Disabled	All set-ups	TRUE	-	Uint8
22-22	Low Speed Detection	[0] Disabled	All set-ups	TRUE	-	Uint8
22-23	No-Flow Function	[0] Off	All set-ups	TRUE	-	Uint8
22-24	No-Flow Delay	10 s	All set-ups	TRUE	0	Uint16
22-26	Dry Pump Function	[0] Off	All set-ups	TRUE	-	Uint8
22-27	Dry Pump Delay	10 s	All set-ups	TRUE	0	Uint16
22-28	No-Flow Low Speed [RPM]	SR	All set-ups	TRUE	67	Uint16
22-29	No-Flow Low Speed [Hz]	SR	All set-ups	TRUE	-1	Uint16
<b>22-3* No-Flow Power Tuning</b>						
22-30	No-Flow Power	0.00 kW	All set-ups	TRUE	1	Uint32
22-31	Power Correction Factor	100 %	All set-ups	TRUE	0	Uint16
22-32	Low Speed [RPM]	SR	All set-ups	TRUE	67	Uint16
22-33	Low Speed [Hz]	SR	All set-ups	TRUE	-1	Uint16
22-34	Low Speed Power [kW]	SR	All set-ups	TRUE	1	Uint32
22-35	Low Speed Power [HP]	SR	All set-ups	TRUE	-2	Uint32
22-36	High Speed [RPM]	SR	All set-ups	TRUE	67	Uint16
22-37	High Speed [Hz]	SR	All set-ups	TRUE	-1	Uint16
22-38	High Speed Power [kW]	SR	All set-ups	TRUE	1	Uint32
22-39	High Speed Power [HP]	SR	All set-ups	TRUE	-2	Uint32
<b>22-4* Sleep Mode</b>						
22-40	Minimum Run Time	60 s	All set-ups	TRUE	0	Uint16
22-41	Minimum Sleep Time	30 s	All set-ups	TRUE	0	Uint16
22-42	Wake-up Speed [RPM]	SR	All set-ups	TRUE	67	Uint16
22-43	Wake-up Speed [Hz]	SR	All set-ups	TRUE	-1	Uint16
22-44	Wake-up Ref./FB Difference	10 %	All set-ups	TRUE	0	Int8
22-45	Setpoint Boost	0 %	All set-ups	TRUE	0	Int8
22-46	Maximum Boost Time	60 s	All set-ups	TRUE	0	Uint16
<b>22-5* End of Curve</b>						
22-50	End of Curve Function	[0] Off	All set-ups	TRUE	-	Uint8
22-51	End of Curve Delay	10 s	All set-ups	TRUE	0	Uint16
<b>22-6* Broken Belt Detection</b>						
22-60	Broken Belt Function	[0] Off	All set-ups	TRUE	-	Uint8
22-61	Broken Belt Torque	10 %	All set-ups	TRUE	0	Uint8
22-62	Broken Belt Delay	10 s	All set-ups	TRUE	0	Uint16
<b>22-7* Short Cycle Protection</b>						
22-75	Short Cycle Protection	[0] Disabled	All set-ups	TRUE	-	Uint8
22-76	Interval between Starts	start_to_start_min_on_time (P2277)	All set-ups	TRUE	0	Uint16
22-77	Minimum Run Time	0 s	All set-ups	TRUE	0	Uint16

Par. No. #	Parameter description	Default value	4-set-up	Change during operation	Conversion index	Type
<b>22-8* Flow Compensation</b>						
22-80	Flow Compensation	[0] Disabled	All set-ups	TRUE	-	UInt8
22-81	Square-linear Curve Approximation	100 %	All set-ups	TRUE	0	UInt8
22-82	Work Point Calculation	[0] Disabled	All set-ups	TRUE	-	UInt8
22-83	Speed at No-Flow [RPM]	SR	All set-ups	TRUE	67	UInt16
22-84	Speed at No-Flow [Hz]	SR	All set-ups	TRUE	-1	UInt16
22-85	Speed at Design Point [RPM]	SR	All set-ups	TRUE	67	UInt16
22-86	Speed at Design Point [Hz]	SR	All set-ups	TRUE	-1	UInt16
22-87	Pressure at No-Flow Speed	0.000 N/A	All set-ups	TRUE	-3	Int32
22-88	Pressure at Rated Speed	999999.999 N/A	All set-ups	TRUE	-3	Int32
22-89	Flow at Design Point	0.000 N/A	All set-ups	TRUE	-3	Int32
22-90	Flow at Rated Speed	0.000 N/A	All set-ups	TRUE	-3	Int32

**3.1.20 Timed Actions 23-\*\***

Par. No. #	Parameter description	Default value	4-set-up	Change during operation	Conversion index	Type
<b>23-0* Timed Actions</b>						
23-00	ON Time	SR	2 set-ups	TRUE	0	TimeOfDay- WoDate
23-01	ON Action	[0] Disabled	2 set-ups	TRUE	-	Uint8
23-02	OFF Time	SR	2 set-ups	TRUE	0	TimeOfDay- WoDate
23-03	OFF Action	[0] Disabled	2 set-ups	TRUE	-	Uint8
23-04	Occurrence	[0] All days	2 set-ups	TRUE	-	Uint8
<b>23-1* Maintenance</b>						
23-10	Maintenance Item	[1] Motor bearings	1 set-up	TRUE	-	Uint8
23-11	Maintenance Action	[1] Lubricate	1 set-up	TRUE	-	Uint8
23-12	Maintenance Time Base	[0] Disabled	1 set-up	TRUE	-	Uint8
23-13	Maintenance Time Interval	1 h	1 set-up	TRUE	74	Uint32
23-14	Maintenance Date and Time	SR	1 set-up	TRUE	0	TimeOfDay
<b>23-1* Maintenance Reset</b>						
23-15	Reset Maintenance Word	[0] Do not reset	All set-ups	TRUE	-	Uint8
23-16	Maintenance Text	0 N/A	1 set-up	TRUE	0	VisStr[20]
<b>23-5* Energy Log</b>						
23-50	Energy Log Resolution	[5] Last 24 Hours	2 set-ups	TRUE	-	Uint8
23-51	Period Start	SR	2 set-ups	TRUE	0	TimeOfDay
23-53	Energy Log	0 N/A	All set-ups	TRUE	0	Uint32
23-54	Reset Energy Log	[0] Do not reset	All set-ups	TRUE	-	Uint8
<b>23-6* Trending</b>						
23-60	Trend Variable	[0] Power [kW]	2 set-ups	TRUE	-	Uint8
23-61	Continuous Bin Data	0 N/A	All set-ups	TRUE	0	Uint32
23-62	Timed Bin Data	0 N/A	All set-ups	TRUE	0	Uint32
23-63	Timed Period Start	SR	2 set-ups	TRUE	0	TimeOfDay
23-64	Timed Period Stop	SR	2 set-ups	TRUE	0	TimeOfDay
23-65	Minimum Bin Value	SR	2 set-ups	TRUE	0	Uint8
23-66	Reset Continuous Bin Data	[0] Do not reset	All set-ups	TRUE	-	Uint8
23-67	Reset Timed Bin Data	[0] Do not reset	All set-ups	TRUE	-	Uint8
<b>23-8* Payback Counter</b>						
23-80	Power Reference Factor	100 %	2 set-ups	TRUE	0	Uint8
23-81	Energy Cost	1.00 N/A	2 set-ups	TRUE	-2	Uint32
23-82	Investment	0 N/A	2 set-ups	TRUE	0	Uint32
23-83	Energy Savings	0 kWh	All set-ups	TRUE	75	Int32
23-84	Cost Savings	0 N/A	All set-ups	TRUE	0	Int32

**3.1.21 Cascade Controller 25-\*\*-\***

Par. No. #	Parameter description	Default value	4-set-up	Change during operation	Conversion index	Type
<b>25-0* System Settings</b>						
25-00	Cascade Controller	null	2 set-ups	FALSE	-	Uint8
25-02	Motor Start	[0] Direct on Line	2 set-ups	FALSE	-	Uint8
25-04	Pump Cycling	null	All set-ups	TRUE	-	Uint8
25-05	Fixed Lead Pump	null	2 set-ups	FALSE	-	Uint8
25-06	Number of Pumps	2 N/A	2 set-ups	FALSE	0	Uint8
<b>25-2* Bandwidth Settings</b>						
25-20	Staging Bandwidth	SR	All set-ups	TRUE	0	Uint8
25-21	Override Bandwidth	100 %	All set-ups	TRUE	0	Uint8
25-22	Fixed Speed Bandwidth	casco_staging_bandwidth (P2520)	All set-ups	TRUE	0	Uint8
25-23	SBW Staging Delay	15 s	All set-ups	TRUE	0	Uint16
25-24	SBW Destaging Delay	15 s	All set-ups	TRUE	0	Uint16
25-25	OBW Time	10 s	All set-ups	TRUE	0	Uint16
25-26	Destage At No-Flow	[0] Disabled	All set-ups	TRUE	-	Uint8
25-27	Stage Function	null	All set-ups	TRUE	0	Uint8
25-28	Stage Function Time	15 s	All set-ups	TRUE	0	Uint16
25-29	Destage Function	null	All set-ups	TRUE	-	Uint8
25-30	Destage Function Time	15 s	All set-ups	TRUE	0	Uint16
<b>25-4* Staging Settings</b>						
25-40	Ramp Down Delay	10.0 s	All set-ups	TRUE	-1	Uint16
25-41	Ramp Up Delay	2.0 s	All set-ups	TRUE	-1	Uint16
25-42	Staging Threshold	SR	All set-ups	TRUE	0	Uint8
25-43	Destaging Threshold	SR	All set-ups	TRUE	0	Uint8
25-44	Staging Speed [RPM]	0 RPM	All set-ups	TRUE	67	Uint16
25-45	Staging Speed [Hz]	0.0 Hz	All set-ups	TRUE	-1	Uint16
25-46	Destaging Speed [RPM]	0 RPM	All set-ups	TRUE	67	Uint16
25-47	Destaging Speed [Hz]	0.0 Hz	All set-ups	TRUE	-1	Uint16
<b>25-5* Alternation Settings</b>						
25-50	Lead Pump Alternation	null	All set-ups	TRUE	-	Uint8
25-51	Alternation Event	[0] External	All set-ups	TRUE	-	Uint8
25-52	Alternation Time Interval	24 h	All set-ups	TRUE	74	Uint16
25-53	Alternation Timer Value	0 N/A	All set-ups	TRUE	0	VisStr[7]
25-54	Alternation Predefined Time	SR	All set-ups	TRUE	0	TimeOfDay- WoDate
25-55	Alternate if Load < 50%	[1] Enabled	All set-ups	TRUE	-	Uint8
25-56	Staging Mode at Alternation	[0] Slow	All set-ups	TRUE	-	Uint8
25-58	Run Next Pump Delay	0.1 s	All set-ups	TRUE	-1	Uint16
25-59	Run on Mains Delay	0.5 s	All set-ups	TRUE	-1	Uint16

# 3

## 3 Parameter Lists



Par. No. #	Parameter description	Default value	4-set-up	Change during operation	Conversion index	Type
<b>25-8* Status</b>						
25-80	Cascade Status	0 N/A	All set-ups	TRUE	0	VisStr[25]
25-81	Pump Status	0 N/A	All set-ups	TRUE	0	VisStr[25]
25-82	Lead Pump	0 N/A	All set-ups	TRUE	0	UInt8
25-83	Relay Status	0 N/A	All set-ups	TRUE	0	VisStr[4]
25-84	Pump ON Time	0 h	All set-ups	TRUE	74	UInt32
25-85	Relay ON Time	0 h	All set-ups	TRUE	74	UInt32
25-86	Reset Relay Counters	[0] Do not reset	All set-ups	TRUE	-	UInt8
<b>25-9* Service</b>						
25-90	Pump Interlock	[0] Off	All set-ups	TRUE	-	UInt8
25-91	Manual Alternation	0 N/A	All set-ups	TRUE	0	UInt8

**3.1.22 Analog I/O Option MCB 109 26-\*\*-\***

Par. No. #	Parameter description	Default value	4-set-up	Change during operation	Conversion index	Type
<b>26-0* Analog I/O Mode</b>						
26-00	Terminal X42/1 Mode	[1] Voltage	All set-ups	TRUE	-	Uint8
26-01	Terminal X42/3 Mode	[1] Voltage	All set-ups	TRUE	-	Uint8
26-02	Terminal X42/5 Mode	[1] Voltage	All set-ups	TRUE	-	Uint8
<b>26-1* Analog Input X42/1</b>						
26-10	Terminal X42/1 Low Voltage	0.07 V	All set-ups	TRUE	-2	Int16
26-11	Terminal X42/1 High Voltage	10.00 V	All set-ups	TRUE	-2	Int16
26-14	Term. X42/1 Low Ref./Feedb. Value	0.000 N/A	All set-ups	TRUE	-3	Int32
26-15	Term. X42/1 High Ref./Feedb. Value	100.000 N/A	All set-ups	TRUE	-3	Int32
26-16	Term. X42/1 Filter Time Constant	0.001 s	All set-ups	TRUE	-3	Uint16
26-17	Term. X42/1 Live Zero	[1] Enabled	All set-ups	TRUE	-	Uint8
<b>26-2* Analog Input X42/3</b>						
26-20	Terminal X42/3 Low Voltage	0.07 V	All set-ups	TRUE	-2	Int16
26-21	Terminal X42/3 High Voltage	10.00 V	All set-ups	TRUE	-2	Int16
26-24	Term. X42/3 Low Ref./Feedb. Value	0.000 N/A	All set-ups	TRUE	-3	Int32
26-25	Term. X42/3 High Ref./Feedb. Value	100.000 N/A	All set-ups	TRUE	-3	Int32
26-26	Term. X42/3 Filter Time Constant	0.001 s	All set-ups	TRUE	-3	Uint16
26-27	Term. X42/3 Live Zero	[1] Enabled	All set-ups	TRUE	-	Uint8
<b>26-3* Analog Input X42/5</b>						
26-30	Terminal X42/5 Low Voltage	0.07 V	All set-ups	TRUE	-2	Int16
26-31	Terminal X42/5 High Voltage	10.00 V	All set-ups	TRUE	-2	Int16
26-34	Term. X42/5 Low Ref./Feedb. Value	0.000 N/A	All set-ups	TRUE	-3	Int32
26-35	Term. X42/5 High Ref./Feedb. Value	100.000 N/A	All set-ups	TRUE	-3	Int32
26-36	Term. X42/5 Filter Time Constant	0.001 s	All set-ups	TRUE	-3	Uint16
26-37	Term. X42/5 Live Zero	[1] Enabled	All set-ups	TRUE	-	Uint8
<b>26-4* Analog Out X42/7</b>						
26-40	Terminal X42/7 Output	[0] No operation	All set-ups	TRUE	-	Uint8
26-41	Terminal X42/7 Min. Scale	0.00 %	All set-ups	TRUE	-2	Int16
26-42	Terminal X42/7 Max. Scale	100.00 %	All set-ups	TRUE	-2	Int16
26-43	Terminal X42/7 Bus Control	0.00 %	All set-ups	TRUE	-2	N2
26-44	Terminal X42/7 Timeout Preset	0.00 %	1 set-up	TRUE	-2	Uint16
<b>26-5* Analog Out X42/9</b>						
26-50	Terminal X42/9 Output	[0] No operation	All set-ups	TRUE	-	Uint8
26-51	Terminal X42/9 Min. Scale	0.00 %	All set-ups	TRUE	-2	Int16
26-52	Terminal X42/9 Max. Scale	100.00 %	All set-ups	TRUE	-2	Int16
26-53	Terminal X42/9 Bus Control	0.00 %	All set-ups	TRUE	-2	N2
26-54	Terminal X42/9 Timeout Preset	0.00 %	1 set-up	TRUE	-2	Uint16
<b>26-6* Analog Out X42/11</b>						
26-60	Terminal X42/11 Output	[0] No operation	All set-ups	TRUE	-	Uint8
26-61	Terminal X42/11 Min. Scale	0.00 %	All set-ups	TRUE	-2	Int16
26-62	Terminal X42/11 Max. Scale	100.00 %	All set-ups	TRUE	-2	Int16
26-63	Terminal X42/11 Bus Control	0.00 %	All set-ups	TRUE	-2	N2
26-64	Terminal X42/11 Timeout Preset	0.00 %	1 set-up	TRUE	-2	Uint16

## 3.1.23 Cascade CTL Option 27-\*\*-\*

Par. No. #	Parameter description	Default value	4-set-up	Change during operation	Conversion index	Type
<b>27-0* Control &amp; Status</b>						
27-01	Pump Status	[0] Ready	All set-ups	TRUE	-	Uint8
27-02	Manual Pump Control	[0] No Operation	2 set-ups	TRUE	-	Uint8
27-03	Current Runtime Hours	0 h	All set-ups	TRUE	74	Uint32
27-04	Pump Total Lifetime Hours	0 h	All set-ups	TRUE	74	Uint32
<b>27-1* Configuration</b>						
27-10	Cascade Controller	[0] Disabled	2 set-ups	FALSE	-	Uint8
27-11	Number Of Drives	1 N/A	2 set-ups	FALSE	0	Uint8
27-12	Number Of Pumps	SR	2 set-ups	FALSE	0	Uint8
27-14	Pump Capacity	100 %	2 set-ups	FALSE	0	Uint16
27-16	Runtime Balancing	[0] Balanced Priority 1	2 set-ups	TRUE	-	Uint8
27-17	Motor Starters	[0] Direct Online	2 set-ups	FALSE	-	Uint8
27-18	Spin Time for Unused Pumps	SR	All set-ups	TRUE	0	Uint16
27-19	Reset Current Runtime Hours	[0] Do not reset	All set-ups	TRUE	-	Uint8
<b>27-2* Bandwidth Settings</b>						
27-20	Normal Operating Range	SR	All set-ups	TRUE	0	Uint8
27-21	Override Limit	100 %	All set-ups	TRUE	0	Uint8
27-22	Fixed Speed Only Operating Range	SR	All set-ups	TRUE	0	Uint8
27-23	Staging Delay	15 s	All set-ups	TRUE	0	Uint16
27-24	Destaging Delay	15 s	All set-ups	TRUE	0	Uint16
27-25	Override Hold Time	10 s	All set-ups	TRUE	0	Uint16
27-27	Min Speed Destage Delay	SR	All set-ups	TRUE	0	Uint16
<b>27-3* Staging Speed</b>						
27-30	Auto Tune Staging Speeds	[1] Enabled	All set-ups	TRUE	-	Uint8
27-31	Stage On Speed [RPM]	SR	All set-ups	TRUE	67	Uint16
27-32	Stage On Speed [Hz]	SR	All set-ups	TRUE	-1	Uint16
27-33	Stage Off Speed [RPM]	SR	All set-ups	TRUE	67	Uint16
27-34	Stage Off Speed [Hz]	SR	All set-ups	TRUE	-1	Uint16
<b>27-4* Staging Settings</b>						
27-40	Auto Tune Staging Settings	[0] Disabled	All set-ups	TRUE	-	Uint8
27-41	Ramp Down Delay	10.0 s	All set-ups	TRUE	-1	Uint16
27-42	Ramp Up Delay	2.0 s	All set-ups	TRUE	-1	Uint16
27-43	Staging Threshold	SR	All set-ups	TRUE	0	Uint8
27-44	Destaging Threshold	SR	All set-ups	TRUE	0	Uint8
27-45	Staging Speed [RPM]	0 RPM	All set-ups	TRUE	67	Uint16
27-46	Staging Speed [Hz]	0.0 Hz	All set-ups	TRUE	-1	Uint16
27-47	Destaging Speed [RPM]	0 RPM	All set-ups	TRUE	67	Uint16
27-48	Destaging Speed [Hz]	0.0 Hz	All set-ups	TRUE	-1	Uint16
<b>27-5* Alternate Settings</b>						
27-50	Automatic Alternation	[0] Disabled	All set-ups	FALSE	-	Uint8
27-51	Alternation Event	null	All set-ups	TRUE	-	Uint8
27-52	Alternation Time Interval	0 min	All set-ups	TRUE	70	Uint16
27-53	Alternation Timer Value	0 min	All set-ups	TRUE	70	Uint16
27-54	Alternation At Time of Day	[0] Disabled	All set-ups	TRUE	-	Uint8
27-55	Alternation Predefined Time	SR	All set-ups	TRUE	0	TimeOfDay- WoDate
27-56	Alternate Capacity is <	0 %	All set-ups	TRUE	0	Uint8
27-58	Run Next Pump Delay	0.1 s	All set-ups	TRUE	-1	Uint16

Par. No. #	Parameter description	Default value	4-set-up	Change during operation	Conversion index	Type
<b>27-6* Digital Inputs</b>						
27-60	Terminal X66/1 Digital Input	[0] No operation	All set-ups	TRUE	-	UInt8
27-61	Terminal X66/3 Digital Input	[0] No operation	All set-ups	TRUE	-	UInt8
27-62	Terminal X66/5 Digital Input	[0] No operation	All set-ups	TRUE	-	UInt8
27-63	Terminal X66/7 Digital Input	[0] No operation	All set-ups	TRUE	-	UInt8
27-64	Terminal X66/9 Digital Input	[0] No operation	All set-ups	TRUE	-	UInt8
27-65	Terminal X66/11 Digital Input	[0] No operation	All set-ups	TRUE	-	UInt8
27-66	Terminal X66/13 Digital Input	[0] No operation	All set-ups	TRUE	-	UInt8
<b>27-7* Connections</b>						
27-70	Relay	[0] Standard Relay	2 set-ups	FALSE	-	UInt8
<b>27-9* Readouts</b>						
27-91	Cascade Reference	0.0 %	All set-ups	TRUE	-1	Int16
27-92	% Of Total Capacity	0 %	All set-ups	TRUE	0	UInt16
27-93	Cascade Option Status	[0] Disabled	All set-ups	TRUE	-	UInt8
27-94	Cascade System Status	0 N/A	All set-ups	TRUE	0	VisStr[25]

3

**3.1.24 Water Application Functions 29-\*\***

Par. No. #	Parameter description	Default value	4-set-up	Change during operation	Conversion index	Type
<b>29-0* Pipe Fill</b>						
29-00	Pipe Fill Enable	[0] Disabled	2 set-ups	FALSE	-	UInt8
29-01	Pipe Fill Speed [RPM]	SR	All set-ups	TRUE	67	UInt16
29-02	Pipe Fill Speed [Hz]	SR	All set-ups	TRUE	-1	UInt16
29-03	Pipe Fill Time	0.00 s	All set-ups	TRUE	-2	UInt32
29-04	Pipe Fill Rate	0.001 ProcessCtrlUnit	All set-ups	TRUE	-3	Int32
29-05	Filled Setpoint	0.000 ProcessCtrlUnit	All set-ups	TRUE	-3	Int32

### 3.1.25 Bypass Option 31-\*\*

Par. No. #	Parameter description	Default value	4-set-up	Change during operation	Conversion index	Type
31-00	Bypass Mode	[0] Drive	All set-ups	TRUE	-	Uint8
31-01	Bypass Start Time Delay	30 s	All set-ups	TRUE	0	Uint16
31-02	Bypass Trip Time Delay	0 s	All set-ups	TRUE	0	Uint16
31-03	Test Mode Activation	[0] Disabled	All set-ups	TRUE	-	Uint8
31-10	Bypass Status Word	0 IN/A	All set-ups	FALSE	0	V2
31-11	Bypass Running Hours	0 h	All set-ups	FALSE	74	Uint32
31-19	Remote Bypass Activation	[0] Disabled	2 set-ups	TRUE	-	Uint8