

DELTRON

controls | DC

DIVISION OF DELTROL CORP.

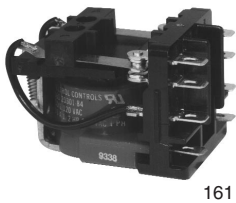

161



166

160 SERIES 5 AND 13 AMP GENERAL PURPOSE PLUG-IN RELAY

FEATURES

- Class F Coil Insulation System for 155°C Total Temperature
- Coil Molded in DuPont Rynite® for Environmental Protection
- Unique Armature Stop Maintains Adjustment
- Fine Wire Gauge Coils are Skined for Coil Integrity

CONTACT DATA

CONFIGURATION:

Thru 3PDT

MATERIALS:

5 AMP:

1/8" Diameter Moveable Fine Silver
3/16" Diameter Stationary Fine Silver

13 AMP:

3/16" Diameter Moveable Silver Cadmium Oxide
3/16" Diameter Stationary Fine Silver

Gold Flash Standard on All Contacts

Gold Diffused Available on Special Order – Min. Qty. Req'd.

CONTACT RATINGS

MODEL	POLE CONFIGURATION	UL RATINGS
160/165	thru 3PDT	5 amp or 1/8 HP at 120VAC 5 amp or 1/4 HP at 277VAC 2 amp at 600VAC 5 amp at 28VDC
161/166	thru 3PDT	13 amp or 1/3 HP at 120VAC 13 amp or 1/2 HP at 277VAC* 10 amp at 28VDC 1 HP at 277VAC - 3 phase 3 amp or 3/4 HP at 600 VAC 12 FLA, 35 LRA at 15VAC
166E (w/Blowout Magnet)	thru DPDT	3 amp at 150VDC 30,000 cycles
	Form X, Y, W, and Z	10 amp at 150VDC 100,000 cycles
MODEL	POLE CONFIGURATION	SEMKO RATINGS
165 F, P, TM	thru 3PDT	5 amp at 250VAC 50 Hz AC-1 5 amp at 28VDC DC-1 2.9 amp at 240VAC 50 Hz AC-3
166 F, P, TM	thru 3PDT	10 amp at 250VAC 50 Hz AC-1 10 amp at 28VDC DC-1 4.9 amp at 240VAC 50 Hz AC-3

*3 Pole Devices Rated at 6-2/3 Amp When Switching Greater Than 150VAC, Unless Polarity is the Same on All Poles.

UL RECOGNIZED FILE NO.: E37066

US and Canadian Recognition

SEMKO CERTIFICATE NO.: 9726189/01-02 Model 165/166 F,P, TM

EXPECTED LIFE

Electrical At Rated Load (Minimum)

100,000 Operations Except as Noted

Mechanical Life

10,000,000 Operations

DIELECTRIC STRENGTH

800 VRMS, 60 Hz Between Contacts

2200 VRMS, 60 Hz Between All Other Elements

MODELS

160: 5 Amp Open Frame 161: 13 Amp Open Frame

165: 5 Amp Covered Plug-In 166: 13 Amp Covered Plug-In

165F: 5 Amp Flanged Cover w/QC Terminals

166F: 13 Amp Flanged Cover w/QC Terminals

166E: Addition of Blowout Magnets – For Higher DC Ratings

Other Suffixes Available

A-Indicator Lamp, B-Push to Test Button

P-Printed Circuit Terminals, TM-Top Mount Cover



COIL DATA



Semko marked upon request model 165/166 F, P, TM

	NOMINAL VOLTAGE	RESISTANCE IN OHMS ± 10%	NOMINAL COIL POWER
AC Coils Single Pole Units	6VAC	5.0	2.0VA
	12VAC	20	
	24VAC	80	
	48VAC	315	
	120VAC	2025	
AC Coils 2 & 3 Pole Units	6VAC	4.5	2.2VA
	12VAC	18	
	24VAC	72	
	48VAC	285	
	120VAC	1850	
DC Coils 1-3 Pole Units	6VDC	30	1.2W
	12VDC	120	
	24VDC	480	
	48VDC	1850	
	110VDC	10,000	

Coil Voltages: USA/Canada

European

AC: Up to 277 Volts/60 Hz

AC: Up to 250 Volts 50/60 Hz

DC: Up to 125 Volts

DC: Up to 125 Volts

Coil Treatment: Molded Rynite® Std. Class F

Insulation Resistance: 100 Megohms Minimum

UL Insulation System File No.: E74443

S155D 155°C Total Temperature Std.

(Covers S105 Class A and S130D Class B Requirements)

OPERATE DATA

Pick Up (at 25°C): AC: Volts 85% or Less of Nominal

DC: Volts 75% or Less of Nominal

Operate Time: Approx. 15 Milliseconds

Release Time: Approx. 15 Milliseconds

ENVIRONMENTAL DATA

Operating Ambient: AC: -45° to 55°C DC: -45° to 70°C

Coil Temperature Rise: (25°C Ambient – Continuous Duty)

AC: 45°C Approx. @ 60 Hz – Use at 50 Hz will

Cause Slight Increase in Coil Rise

DC: 25°C Approx.

MECHANICAL DATA

Terminals: All Versions (Except P suffix)

.187" x .020" Quick Connect/Solder

P suffix Version Printed Circuit Pins

Cover: Clear Polycarbonate – Flammability Rating 94V2

Weight: Approx. 3 oz. (85 g)

DIMENSIONS [Unit Inch (mm)]

SCHEMATICS

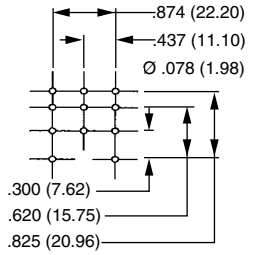
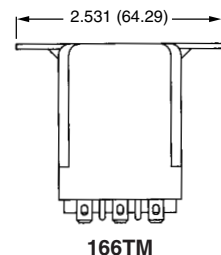
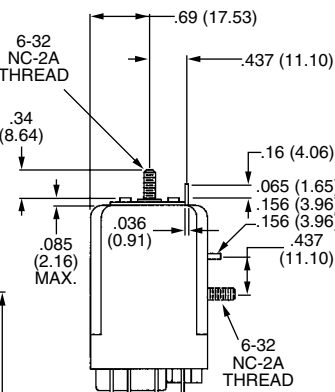
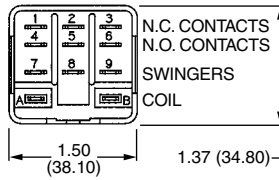
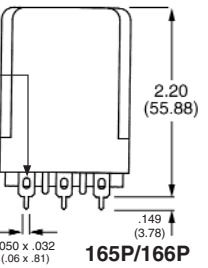
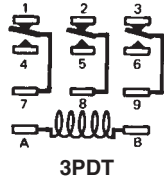
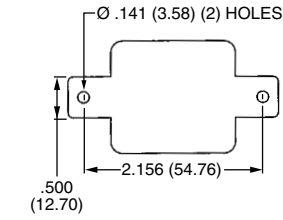
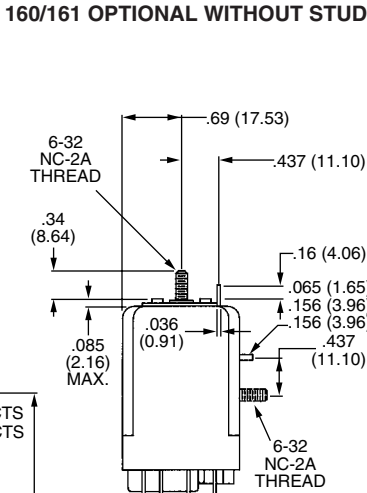
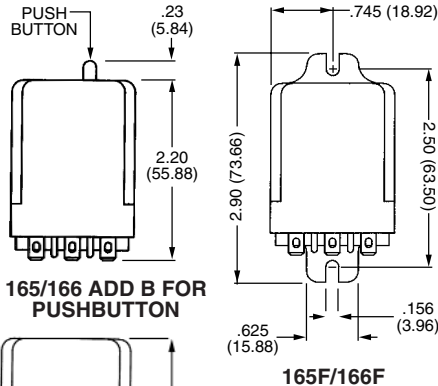
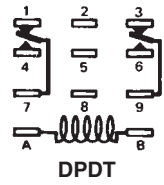
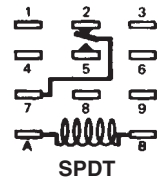
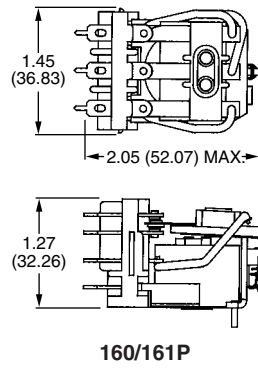
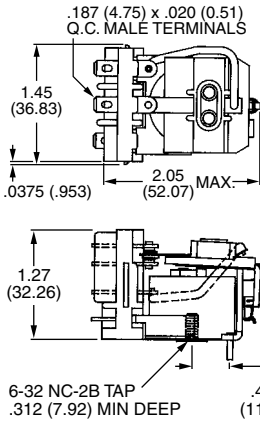
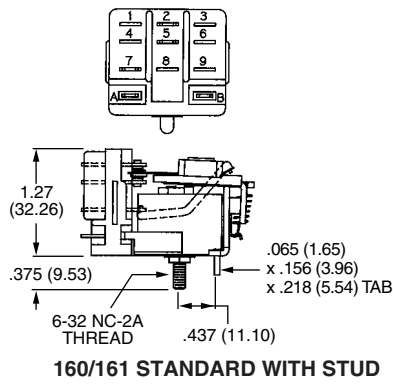

ORDERING INFORMATION

5 AMP Part Numbers

MODEL	POLE CONFIGURATION	AC Coils			DC Coils		
		24VAC	120VAC	240VAC	12VDC	24VDC	110VDC
165	SPDT	20323-82	20323-84	20323-85	20326-81	20326-82	20326-84
	DPDT	20324-82	20324-84	20324-85	20327-81	20327-82	20327-84
	3PDT	20325-82	20325-84*	20325-85	20328-81	20328-82	20328-84
165F	SPDT	20542-82	20542-84	20542-85	20548-81	20548-82	20548-84
	DPDT	20543-82	20543-84	20543-85	20549-81	20549-82	20549-84
	3PDT	20544-82	20544-84	20544-85	20550-81	20550-82	20550-84

13 AMP Part Numbers

161	SPDT	20300-82	20300-84*	20300-85	20303-81	20303-82	20303-84
	DPDT	20301-82	20301-84*	20301-85	20304-81	20304-82	20304-84
	3PDT	20302-82	20302-84	20302-85	20305-81	20305-82	20305-84
166	SPDT	20306-82	20306-84	20306-85	20309-81	20309-82	20309-84
	DPDT	20307-82*	20307-84*	20307-85*	20310-81*	20310-82*	20310-84
	3PDT	20308-82*	20308-84*	20308-85*	20311-81*	20311-82*	20311-84*
166A	SPDT	20379-82	20379-83	20379-84	20382-81	20382-82	20382-83
	DPDT	20380-82	20380-83	20380-84	20383-81	20383-82	20383-83
	3PDT	20381-82*	20381-83*	20381-84	20384-81	20384-82	20384-83
166F	SPDT	20545-82	20545-84	20545-85	20551-81	20551-82	20551-84
	DPDT	20546-82*	20546-84*	20546-85	20552-81	20552-82	20552-84
	3PDT	20547-82*	20547-84*	20547-85	20553-81	20553-82	20553-84

* Black Items are Normally Stocked.

Blue Items are Non Stock. Minimum Quantity May Be Required.

SOCKETS

See Page 30 for Dimensions and Specifications

DIN Rail Mtg	Hold Down Springs	Back Connecting			
DPDT 20982-81 3PDT 20982-82*	For DIN Sockets 20902-03* For Back Connecting 20902-00*	Quick-Connect SPDT 20313-80 DPDT 20313-81* 3PDT 20313-82*	Solder 20312-80* 20312-81* 20312-82*	Deep Barrier Type 20395-80 20395-81 20395-82	Printed Circuit 20314-80* 20314-81* 20314-82*