

RAILWAY APPLICATIONS

Terminal Blocks

ENTRELEC Terminal Blocks

As a leading supplier for railway applications, TE Connectivity proposes the most complete terminal block range of the market complying with all main international railway standards. The ENTRELEC range for railway applications is available in four technologies and covers all the needs for rolling stock and railroad infrastructures.

Railway applications

Terminal blocks

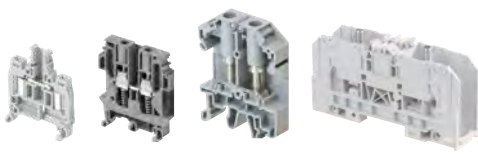
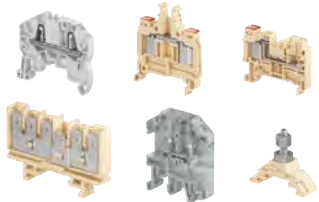

<u>Ranges, solutions and standards presentation</u>	2	1
<u>SNK series, PI-Spring technology</u>	11	2
<u>SNK series, Pluggable technology</u>	69	3
<u>ADO System® IDC and Pluggable technologies</u>	103	4
<u>Quick-connect technology</u>	137	5
<u>Stud technology</u>	169	6
<u>Screw clamp technology complying with NF F 55251 and CT448</u>	207	7
<u>SNK series, Screw clamp technology</u>	219	8
<u>Accessories</u>	309	9
<u>Index</u>	352	10

TE Connectivity proposes one of the largest Din Rail Terminal block offering on the market with various technologies: screw, PI-Spring, spring, IDC, pluggable, stud, etc. found in over 8000 products & solutions.

	SNK terminal blocks		Dedicated applications terminal blocks		Terminal blocks for railway applications
					
Scope	Qualified for worldwide applications and severe environments (such as hazardous locations, railways, marine and solar applications..). From 0.2 to 300 mm ² .		Specific terminal blocks and technologies for dedicated applications and markets.		The largest offering on the market for rolling stock and infrastructures.
Product families & functions	SNK PI-Spring technology 2.5 to 16 mm ² 12 to 4 AWG	Feed-through Multi-deck Ground Disconnect for fuses Component holder	ADO System® (IDC) 0.22 to 4 mm ² 24 to 12 AWG	ADO-ADO or ADO-screw clamp Feed-through / Multi-deck / Ground / Disconnect / for fuses / Component holder	SNK PI-Spring technology 2.5 to 16 mm ² 12 to 4 AWG
			Safety (spring loaded) 0.22 to 10 mm ² 24 to 6 AWG	Feed-through Disconnect Test & measurement	SNK pluggable screw & PI-Spring technologies 2.5 to 4 mm ² 12 to 10 AWG
	SNK screw clamp technology 4 to 240 mm ² 12 to 500 Kcmil	Feed-through Multi-deck Ground Disconnect for fuses Test & measurement Marshalling Component holder	Stud 25 to 300 mm ² 4 AWG to 1000 Kcmil	One stud 2 studs One stud - One screw clamp	ADO System® (IDC) 1.5 to 4 mm ² 16 to 12 AWG
			Ring lug 6 to 16 mm ² 8 to 6 AWG	Feed-through Test & measurement	Stud 4 to 185 mm ²
	SNK pluggable screw & PI-Spring technologies 2.5 to 4 mm ² 12 to 10 AWG	Feed-through Multi-deck Ground	Miniblocks 1.5 to 6 mm ² 18 to 8 AWG	Screw clamp Spring ADO System® (IDC)	Quick-connect 2.5 to 6 mm ²
			Other types Test & measurement: with sliding link, blade, plug Pluggable: feed-through, double deck, disconnect Sensors/actuators: screw, spring, ADO system (IDC) Installation: screw, spring Protection: ground + neutral Component holders: screw, spring, ADO system (IDC)		

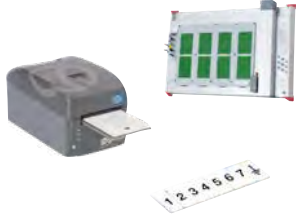

www.te.com

DBL power distribution blocks	ESSAILEC® test blocks	Interfast PLC pre-wiring system	Marking solutions
			
<p>The preferred choice for primary power distribution and solar applications.</p>	<p>Test blocks for safe and easy testing on secondary circuits of current and voltage transformers and sensors.</p>	<p>PLC pre-wiring system for fast, flexible, reliable connection of PLC's in process automation applications.</p>	<p>Markers & marking systems for all identification requirements in electrical panels.</p>
<p>From 80 A up to 550 A (IEC)</p> <p>Modular blocks: single pole, three & four poles, up to 12 outputs</p> <p>Terminal blocks types: 2 to 10 poles, up to 20 outputs</p>	<p>Current and voltage sockets & plugs</p> <p>Simultaneous testing of 1 to 4 independent circuits on the same socket</p> <p>Several testing principle such as "make before break" for safe current transformer testing</p> <p>Panel and switchboard mounting : base, flush, rack, TH35 rail</p> <p>Multicircuits sockets & plugs</p>	<p>Interfast PCB: Compact & standard modules</p> <p>Interfast MS: Modular system based on terminal block technology</p> <p>Functions:</p> <ul style="list-style-type: none"> - 1 to 4 wire connections (sensors) - Disconnect - Fuse - Signal indication - Relays - Optocouplers - Solenoid valve control - Galvanic isolation (2.5 kV). 	<p>Terminal block identification and group markers</p> <p>Wire and cable identification</p> <p>Component and equipment identification</p> <p>Panel identification</p> <p>Pre-printed markers for terminal blocks</p>

ENTRELEC terminal blocks for railway applications

A recognized expertise

TE Connectivity, a worldwide leading supplier for rolling stock and infrastructure

Compliance with main international railway standards

All technologies: PI-Spring, pluggable, ADO System® (IDC), stud and quick-connect

Customized terminal block assemblies: from design to manufacturing and packing

Easy Rail Designer 3D: ease the design of terminal blocks assemblies

Terminal blocks in infrastructure

– Electrical distribution and control panels.



PI-Spring



Screw



Pluggable



Screw
NF F 55251
and CT448

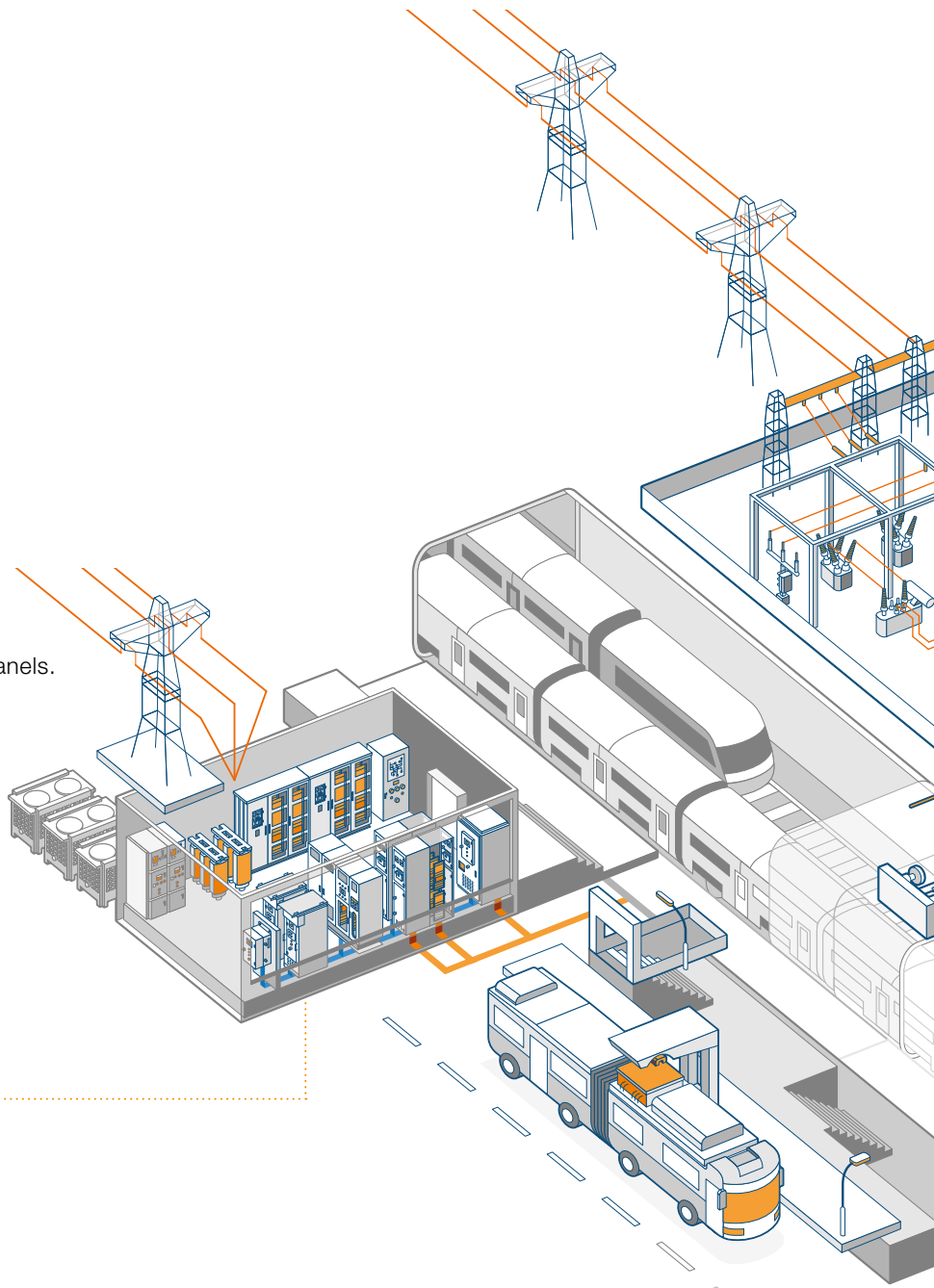
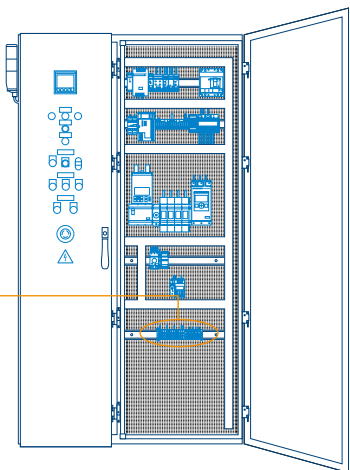

Terminal blocks in rolling stock

- HVAC
- Door control
- Electrical distribution
- Control system and Pilot center.



PI-Spring



Quick-connect



Pluggable



Stud



ADO System® IDC



Ring lug

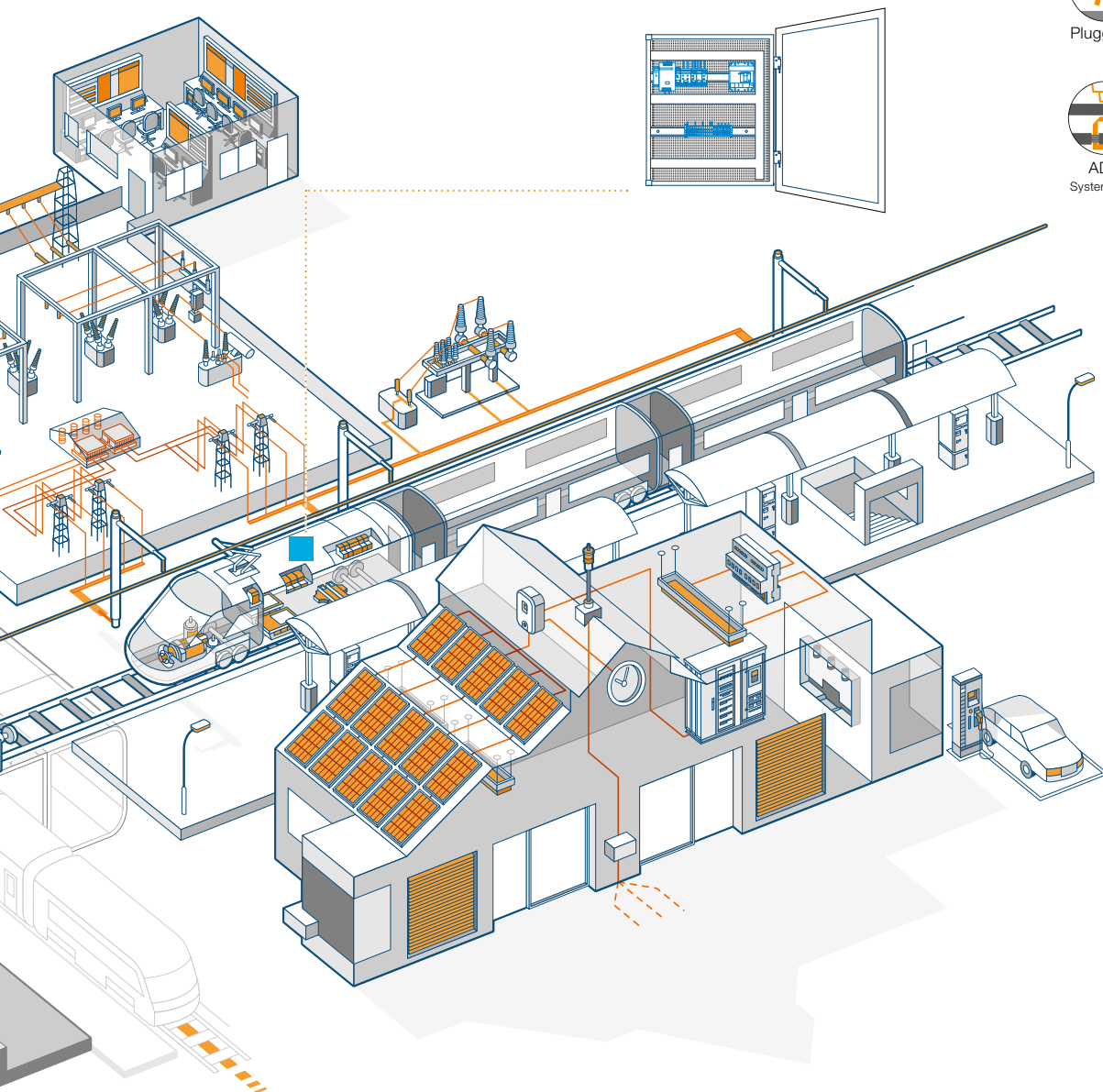

ENTRELEC terminal blocks for railway applications

Overview of ranges



SNK series, PI-Spring and pluggable technologies

The benefits of 2 technologies in 1 connection

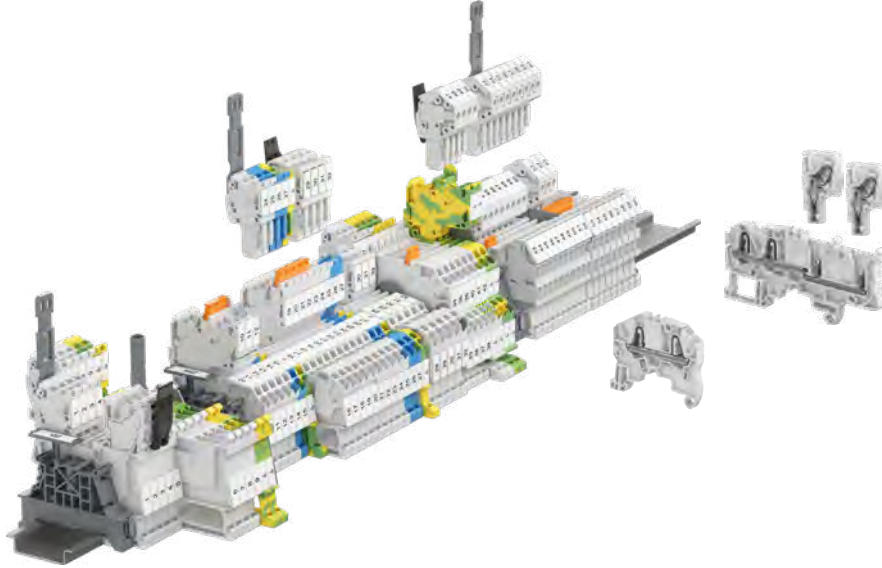

ADO System® IDC and pluggable technologies

The fastest connection technology for rolling stock

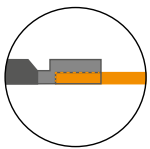
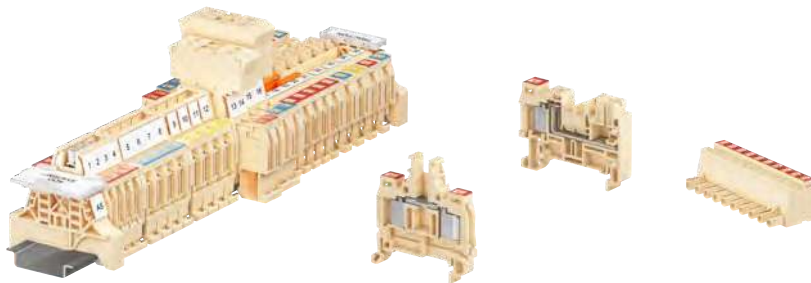

Quick-connect technology

The historical technology for railway control and signal distribution



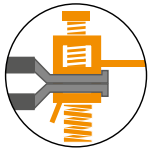

Stud technology

The "Pull-out proof" connection for rolling stock

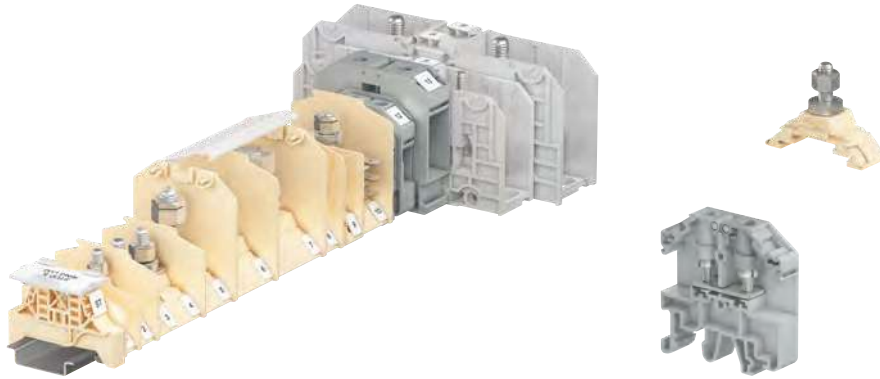

Screw clamp technology complying with NF F 55251 and CT448

The proven reliability and performance for railway infrastructure



SNK series, Screw clamp technology

A smart design to support your daily connection challenges



Standards and compliance

Rail vehicles are subjected to extreme environmental conditions (high vibration and shock), corrosion (underground applications or tunnels).

All ENTRELEC terminal blocks listed in this catalog are tested in accordance with the latest and most demanding standards applying to rolling stock applications.



IEC 61373 railway applications – Rolling stock equipment – Shock and vibration tests
TE Connectivity terminal blocks are complying with **category 1 (body mounted) class B**.

EN 45545-2 railway applications. Fire protection on railway vehicles. Requirements for fire behavior of materials and components

TE Connectivity terminal blocks plastic materials are rated **HL3 R22 (the highest Hazard level)**. They can be used on vehicles for subway, tube, sleeping and couchette.

NF F 16-101 Directive relative to selecting materials in relation to their fire resistance in terms of its behavior in a fire, the opacity of smoke and the toxicity of the gas released.

NF F 16-102 Complement to NF F 16-101. The purpose of this standard is to specify the application of NF F 16-101 to electrical equipment and especially to individual apparatus.

TE Connectivity terminal blocks plastic materials are rated **I2F2. Level 3**. This level concern products mounted inside a room for passengers or running crew.

UL94 (North America) standard for safety of Flammability of Plastic Materials for parts in devices and Appliances testing

TE Connectivity terminal blocks plastic materials are rated **UL94 V0**.

NFPA 130 (North America) standard for Fixed Guideway Transit and Passenger rail systems

TE Connectivity terminal blocks plastic materials complies with **NFPA130 per ASTM E 162** and **ASTM E 662** standards tests. It also complies with **FRA238.103** and **BSS 7239** standards.

UNI CEI 11170-3 (Italy) Fire Test to Railway Components

TE Connectivity terminal blocks have their plastic materials in accordance with the FS Italian standard UNI EN 11170-3 according to the test conditions of ISO 11925-2 (flame 30s) and NF F 16-101 (F2 index).

Railway solutions and tools

Easy Rail Designer 3D, Terminal block assembly software

Engineering, do it yourself easily



Advanced 3D drawing and data export

- Built-in 3D viewer
- Integration to CAD/CAE softwares
- Compatibility with TE Connectivity printers
- Detailed drawings of the rail, assembly and markers.

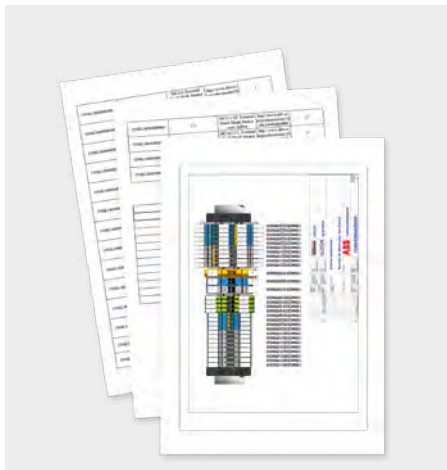

Customized project management

- Management of multiple projects
- Indication on the drawing of the supplier's, integrator's and end user's data
- Drawing update indexing with PDF report.



User-friendly configurator

- Intuitive Windows® (1) user interface
- Autocorrecting system
- Powerful search engine
- Insertion of products external to the database.

(1) Windows® is a registered trademark of Microsoft.

Assembling, rely on TE Connectivity expertise



TE Connectivity technical expertise

- Drawing technical verification done by TE Connectivity experts
- 100% reliable data import to TE Connectivity production system.



Flexible production

- 3 types of assembly:
 - rail mounted
 - pre-assembled
 - packed in kit.
- Possibility to add some other TE Connectivity Din rail products.



Optimized inventory

- Products and markers stocked by TE Connectivity
- Marking managed by TE Connectivity
- One single product part number corresponds to one complete assembly.

15NC16710150201

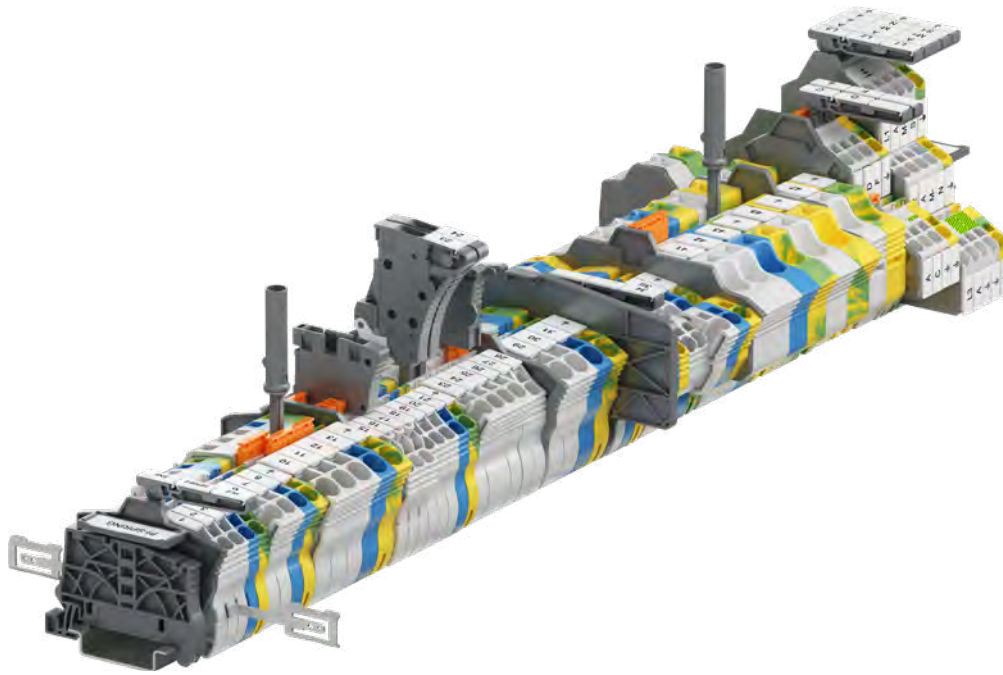

Railway applications, terminal blocks

PI-Spring technology

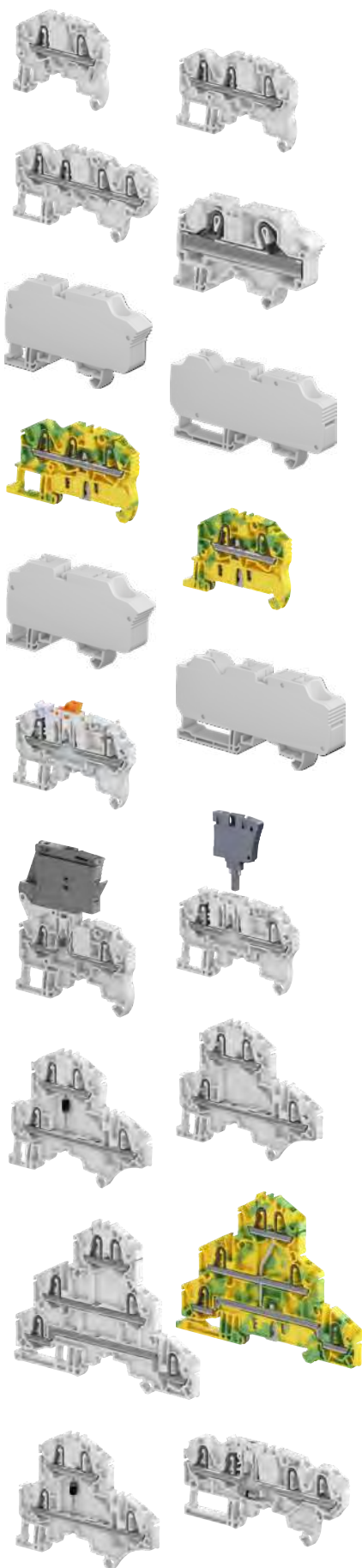

Technologies presentation		12
Overview		18
Feed-through		
2.5 mm ² / 12 AWG	ZK2.5	19
	ZK2.5-3P with 3 connections	20
	ZK2.5-4P with 4 connections	21
4 mm ² / 10 AWG	ZK4	22
	ZK4-3P with 3 connections	23
	ZK4-4P with 4 connections	24
6 mm ² / 8 AWG	ZK6	25
	ZK6-3P with 3 connections	26
10 mm ² / 6 AWG	ZK10	27
	ZK10-PV	28
	ZK10-3P with 3 connections	29
	ZK10-3P-PV with 3 connections	30
16 mm ² / 4 AWG	ZK16	31
	ZK16-PV	32
	ZK16-3P with 3 connections	33
	ZK16-3P-PV with 3 connections	34
Ground		
2.5 mm ² / 12 AWG	ZK2.5-PE	35
	ZK2.5-PE-3P with 3 connections	36
	ZP2.5-PE-4P with 4 connections	37
4 mm ² / 10 AWG	ZK4-PE	38
	ZK4-PE-3P with 3 connections	39
	ZK4-PE-4P with 4 connections	40
6 mm ² / 8 AWG	ZK6-PE	41
	ZK6-PE-3P with 3 connections	42
10 mm ² / 6 AWG	ZK10-PE	43
	ZK10-PE-3P with 3 connections	44
16 mm ² / 4 AWG	ZK16-PE	45
	ZK16-PE-3P with 3 connections	46
Disconnect with blade		
2.5 mm ² / 12 AWG	ZK2.5-S with test sockets	47
	ZK2.5-S-4P with test sockets	48
	ZK2.5-S-R1	49
Disconnect with plug		
2.5 mm ² / 12 AWG	ZK2.5-SP with test sockets	50
	ZK2.5-SP-4P with test sockets	51
For 5x20 fuses		
2.5 mm ² / 12 AWG	ZK2.5-SF	52
	ZK2.5-SF-R with blown fuse indicator	53
Double deck		
2.5 mm ² / 12 AWG	ZK2.5-D2 2 feed-through circuits	54
	ZK2.5-D1 1 feed-through circuit	55
	ZK2.5-D2-PE 1 feed-through circuit and 1 ground circuit	56
	ZK2.5-D1-PE 1 ground circuit	57
Triple deck		
2.5 mm ² / 12 AWG	ZK2.5-T3 3 feed-through circuits	58
	ZK2.5-T1 1 feed-through circuit	59
	ZK2.5-L-L-PE	60
	ZK2.5-L-N-PE 2 feed-through circuits and 1 ground circuit	61
	ZK2.5-T1-PE 1 ground circuit	62
Component holder		
2.5 mm ² / 12 AWG	ZK2.5-CH-4P-LR	63
	ZK2.5-CH-4P-RL	64
	ZK2.5-D-CH-UD	65
	ZK2.5-D-CH-DU	66
	ZK2.5-D-CH2-DU-RL	67

PI-Spring technology - SNK series, terminal blocks

Features and benefits

The patented PI-Spring technology provides the benefits of both Push-In and Spring technologies in one connection



Speed up your projects

50% faster connection time with Push-in mode

Our Push-in connection technology allows:
A direct one step insertion with rigid and prepared flexible conductors.
Easy and quick insertion of the prepared flexible conductor or rigid conductor.

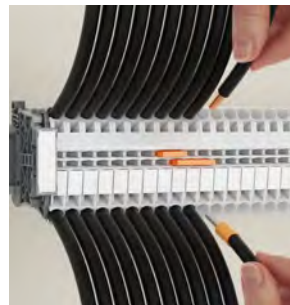

Push-in mode



Spring mode

Reduced effort and conductor preparation time with spring mode

- Our connection requires minimal effort to insert wires with the screwdriver
- Flexible conductors preparation is not necessary.
- The screwdriver locks onto terminal freeing up hands.

Better project identification

- Circuit identification is improved thanks to the 20% larger marking area
- Pre-mark by hand or with label on our flat marking surface and start immediately the wiring, before the final markers mounting
- Spare markers re-printing in case of modifications.

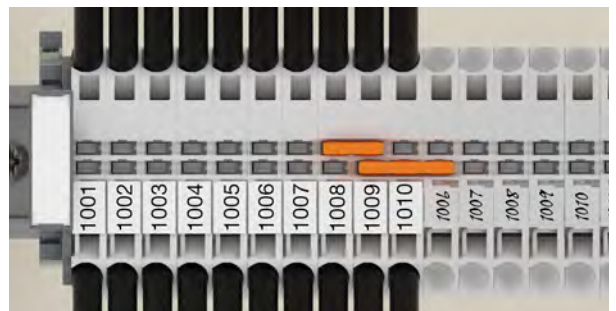

Clear circuit identification

1SNK162074S0201

PI-Spring technology - SNK series, terminal blocks

Features and benefits

Easy to install

Smart design facilitating assembly process

Mounting, wiring, testing... made easy

Avoid mounting and wiring errors: asymmetrical design allows immediate visual check in case of reversed terminal blocks.



Asymmetrical design avoids mounting error

Faster accessories mounting

Save up to 70% mounting time thanks to :

- screwless jumpers, component plugs, test devices, end stops and snap-in ground terminal blocks.



Screwless accessories

Snap-in ground terminal blocks

Closed jumper location allows great stiffness of the terminal block, avoid deflection while tightening and optimal jumper guiding.

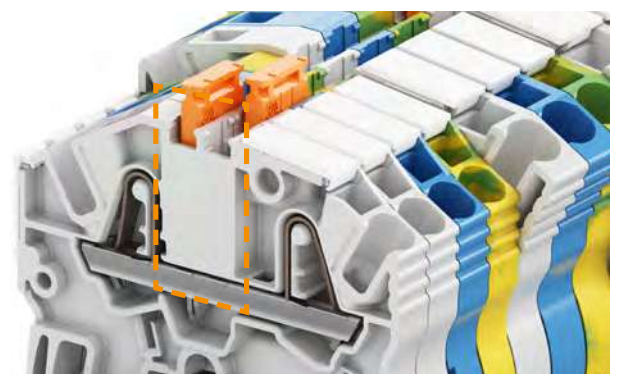

Closed jumper location for stiffness.

PI-Spring technology - SNK series, terminal blocks

Features and benefits

Easy to install

Smart accessories

Flexible test solutions from individual insulated test adapter to test connectors for complete assemblies testing.

- Direct plug-in into jumpers channels
- 5, 6, 8 mm spacing, mixing various spacing is possible
- 1000 V rating.



Plug-in individual test adapter.

Plug-in test connector.

Component holder plugs for series or parallel component mounting (resistors, filters, diodes...).

Can be installed after wiring.

Series plug offers screwless component connection (no soldering).



Series plug associated with disconnect blocks.

Parallel plug to be installed between 2 blocks.

Smart plug-in jumpers:

Pre-cut poles removable by hand: clean cut.

Insulated up to 1000 V (avoid use of separators).

Predefined shapes in molding to easily identify connected poles with a pen.

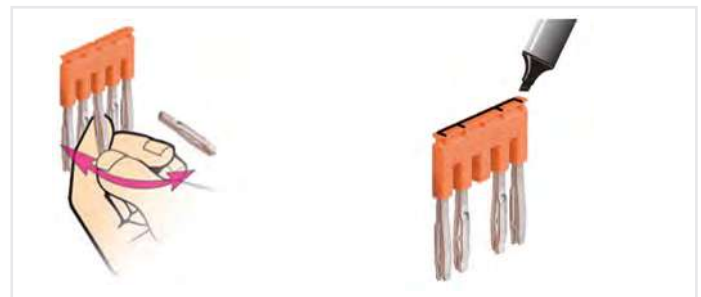

Pre-cut poles easy removable by hand.

Predefined shape to identify connected poles.

PI-Spring technology - SNK series, terminal blocks

Features and benefits

Optimized logistics

Reduce your accessories inventory by up to 50%

SNK PI-Spring, screw and pluggable ranges share the same accessories.

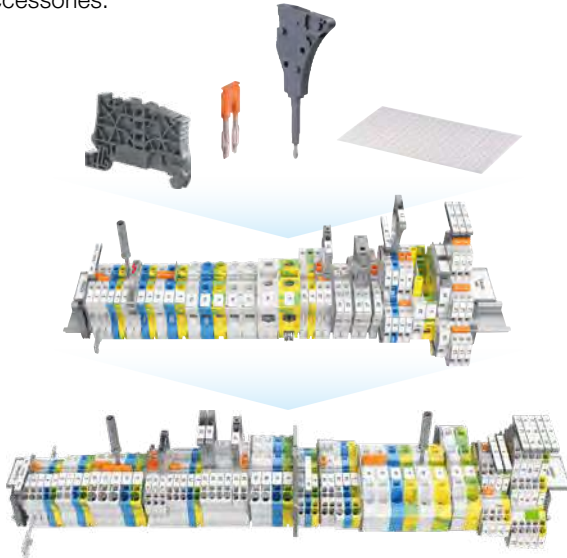

Shared accessories for SNK PI-Spring, screw and pluggable ranges

- All end sections and circuit separators fit several types and sizes of blocks
- One end section fits up to 21 models
- One circuit separator fits with 62 terminal blocks.



End sections and circuit separators fit several types and sizes of blocks

50% less inventory makes PI-Spring attractive to all worldwide markets

- The user selects one range but benefit from 2 connection modes (push-in and spring) which have global certifications and access to markets and applications worldwide
- Reduced packaging adapted to the usage (20 items packaging on some items).



Push-in range + Spring range

PI-Spring

Facilitate maintenance operations

Terminal blocks can be individually removed from a terminal assembly equipped with markers: TE Connectivity markers become independent after strip mounting. The markers remain on terminal in any situation.

Markers are interchangeable: the smaller marker can fit any bigger block.



Maintenance operations facilitated

Reliable in harsh conditions

Qualified for worldwide markets, applications and for severe environments: vibration, shock, corrosion...

High corrosion resistance

PI-Spring clamp is made of high quality stainless steel. Salt mist withstand up to 1,000 hours (as per IEC 60068).



SNK series, terminal blocks

PI-Spring technology - Range overview from 2.5 to 16 mm² - 12 to 4 AWG

2 Connections



Single deck

Feed-through
Ground
Disconnect
Fuse
Solar : 1500 VDC

NEW

3 Connections



Single deck

Feed-through
Ground
Solar: 1500 VDC

NEW

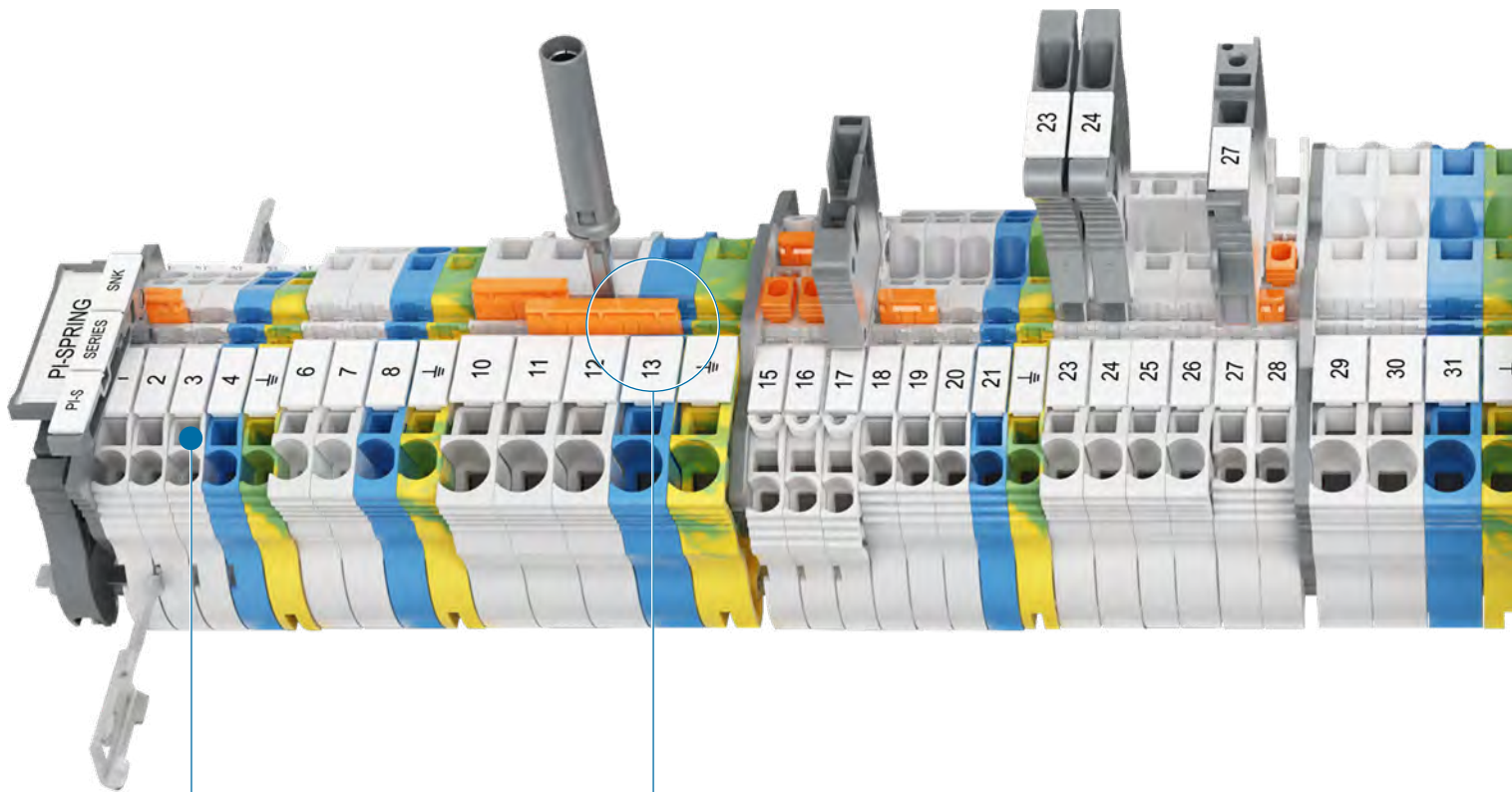

Voltage test

screwdriver entry
point accepts
Category II probes

Double central channels

allows multiconfigurations
(jumping, testing and measuring)

4



Connections

Single deck

Feed-through
Ground
Disconnect
Component holder

2x2



Connections

Double deck

Feed-through
Ground
Component holder

3x2

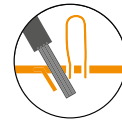

Connections

Triple deck

Feed-through
Ground

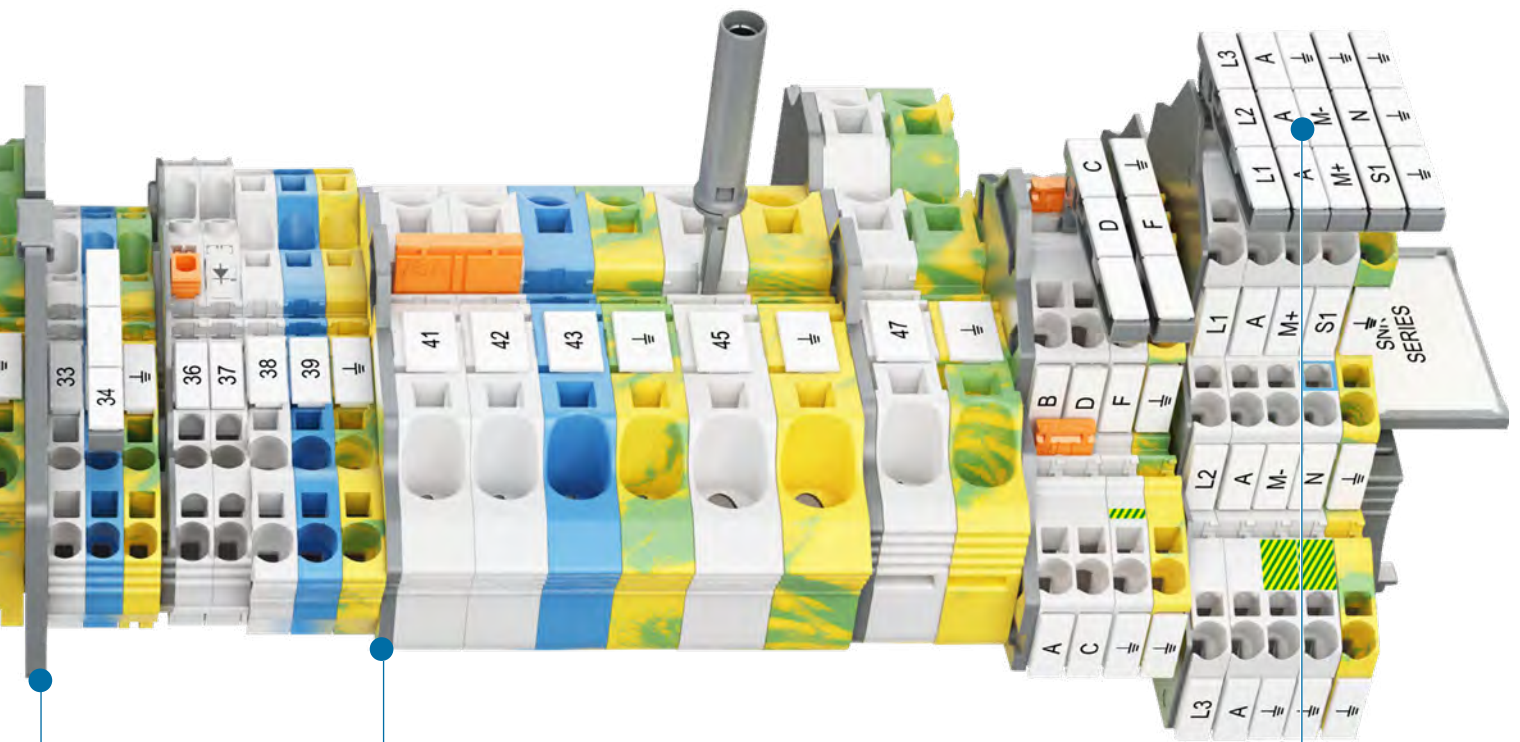

Two circuit separators

for the entire range

End section

can be used as circuit separator

Rotating label holder

easy plug-in in jumper channel

SNK series, terminal blocks

PI-Spring technology



		Feed-through			Ground			Component holder	
Section									
2.5 mm ²	12 AWG	ZK2.5	ZK2.5-3P	ZK2.5-4P	ZK2.5-PE	ZK2.5-PE-3P	ZK2.5-PE 4P	ZK2.5-CH-4P-LR	ZK2.5-CH-4P-RL
4 mm ²	10 AWG	ZK4	ZK4-3P	ZK4-4P	ZK4-PE	ZK4-PE-3P	ZK4-PE- 4P		
6 mm ²	8 AWG	ZK6	ZK6-3P		ZK6-PE	ZK6-PE-3P			
10 mm ²	6 AWG	ZK10	ZK10-3P		ZK10-PE	ZK10-PE-3P			
16 mm ²	4 AWG	ZK10-PV New	ZK10-3P-PV						
		ZK16	ZK16-3P		ZK16-PE	ZK16-PE-3P			
		ZK16-PV New	ZK16-3P-PV						

		Feed-through		Ground		Component holder		
Section								
2.5 mm ²	12 AWG	ZK2.5-D2	ZK2.5-D1	ZK2.5-D2-PE	ZK2.5-D1-PE	ZK2.5-D-CH-UD	ZK2.5-D-CH-DU	ZK2.5-D-CH2-DU-RL

		Feed-through		Ground	
Section					
2.5 mm ²	12 AWG	ZK2.5-T3	ZK2.5-T1	ZK2.5-L-L-PE	ZK2.5-L-N-PE
					ZK2.5-T1-PE

		With blade		With plug		For 5x20 mm fuses		Aligned with ZK2.5-SF
Section								
2.5 mm ²	12 AWG	ZK2.5-S	ZK2.5-S-4P	ZK2.5-SP	ZK2.5-SP-4P	ZK2.5-SF	ZK2.5-SF-R1	ZK2.5-S-R1
							ZK2.5-SF-R3	

Clamp -
 Channels for jumpering or testing -
 Test socket -
 Blown-fuse indicator

1SNK162020S0201 - Rev. B

ZK2.5 PI-Spring terminal blocks

Feed-through - 5.2 mm 0.205 in spacing



ZK2.5

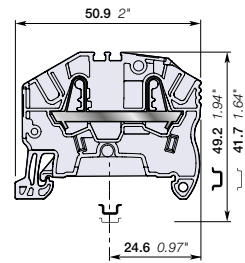

5.2 mm 0.205 in spacing

Description

Combine high performance with compact dimensions:

- 1000 V AC / DC IEC 600 V UL,
- Opt for the best marking visibility thanks to the up-front, flat marker zone, which lets you mark up to eight digits or increase the font size.

Ordering details

Description	Color	Type	Part Number	Pkg qty	Weight (1 pce) g
Feed-through 2 connections	Grey	ZK2.5	1SNK705010R0000	50	5.50
	Blue	ZK2.5-BL	1SNK705020R0000	50	5.50
	Orange	ZK2.5-OR	1SNK705030R0000	50	5.50
	Yellow	ZK2.5-YL	1SNK705060R0000	50	5.50
	Green	ZK2.5-GN	1SNK705061R0000	50	5.50
	Red	ZK2.5-RD	1SNK705062R0000	50	5.50
	White	ZK2.5-WH	1SNK705065R0000	50	5.50
	Black	ZK2.5-BK	1SNK705066R0000	50	5.50

Main technical data

Connecting capacity	IEC	UL - CSA	Rail	Wire stripping length	TH 35-7.5, TH 35-15
1 conductor per clamp	Rigid: Solid/Stranded	0.2 ... 4 mm²	26 ... 12 AWG		
	Flexible without ferrule	0.22 ... 2.5 mm²		11 mm	0.433 in
	Flexible with non insulated ferrule	0.22 ... 2.5 mm²	26 ... 14 AWG		
	Flexible with insulated ferrule	0.22 ... 2.5 mm²	26 ... 14 AWG		
2 conductors per clamp	Flexible with twin ferrule	0.22 ... 0.5 mm²	26 ... 20 AWG	Tool (for flexible conductor without ferrule)	Flat screwdriver Ø 3.5 mm Ø 0.138 in
Rated current / Rated cross section		24 A / 2.5 mm²	20 A / 12 AWG		
Rated short-time withstand current (1s)		300 A	396 A		
Short Circuit Current Rating (with specific conditions)			100 kA		
Rated voltage		1000 V	600 V		
Impulse withstand voltage		8000 V			
Protection		IP20	NEMA 1		

Increased safety Ex e 693 V 21 A IEC/EN 60079-7 - IM2 II 2 GD Ex eb I/II/III/C

The connecting capacity data for one Rigid: Solid/Stranded, or one Flexible conductor (when applicable) is a mandatory information required by IEC, UL and CSA standards (Copper conductors). All other data are provided as supplementary information only. For more details, please consult our CB, UL or CSA certificates and technical datasheet available on <http://www.TE.com>

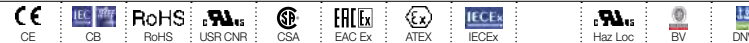

Accessories

Description	Color	Type	Part Number	Pkg qty	Weight (1 pce) g	
1 End stops	Dark grey	BAZ1	1SNK900002R0000	50	5.30	
2 End sections	Dark grey	EK2.5	1SNK705910R0000	20	1.80	
3 Jumper bars	Orange	2 poles	JB5-2	1SNK905302R0000	50	1.30
		3 poles	JB5-3	1SNK905303R0000	50	2.00
		4 poles	JB5-4	1SNK905304R0000	50	2.70
		5 poles	JB5-5	1SNK905305R0000	50	3.50
		10 poles	JB5-10	1SNK905310R0000	30	7.10
		50 poles	JB5-50	1SNK905350R0000	10	36.00
4 Cross spacing jumpers	Orange	JB85-3	1SNK900603R0000	10	2.80	
5 Circuit separators	Dark grey	CS-R2	1SNK900106R0000	20	3.80	
6 Test adapters	Dark grey	For test plugs DIA 2 mm 0.079 in	TP2	1SNK900203R0000	20	1.70
		For test plugs DIA 4 mm 0.157 in	TP4	1SNK900205R0000	20	2.40
7 Test connectors	Dark grey	5.2 mm 0.205 in spacing	TC5	1SNK900200R0000	10	5.20
		End module, 5.2 mm 0.205 in	TC5-R1	1SNK900201R0000	10	5.20
8 Shield connectors		SHBP	1SNK900601R0000	20	4.10	
9 Terminal block markers	White	Blank marker	MG-CPM 13 41790	1SNB041790R0512	1960	0.23
		Blank card	MC512	1SNK140000R0000	22	9.00
			MC512PA	1SNK149999R0000	20	10.00
		Universal wire markers holder	UMH	1SNK900611R0000	10	0.20

Complete list of accessories is indicated in the terminal block datasheet including end stops.

Some accessories such as jumper bars may modify the terminal block's ratings: Complete information available in the accessories section of the catalog.

Ground PI-Spring terminal blocks

Description	Color	Type	Part Number	Pkg qty	Weight (1 pce) g
Ground	Green-yellow	ZK2.5-PE	1SNK705150R0000	20	10.00

Technical data valid for copper conductors only.

ZK2.5-3P PI-Spring terminal blocks

Feed-through with 3 connections - 5.2 mm 0.205 in spacing

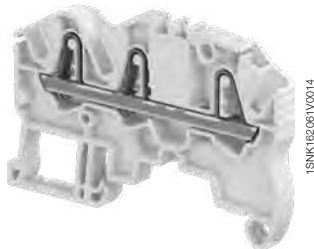

ZK2.5-3P

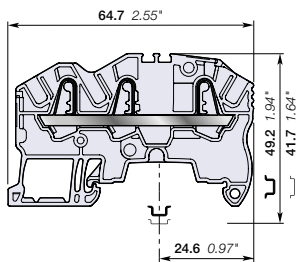

5.2 mm 0.205 in spacing

Description

Find all the features of the ZK2.5 terminal block with the added option of distributing or branching 3 conductors.

Ordering details

Description	Color	Type	Part Number	Pkg qty	Weight (1 pce) g
Feed-through 3 connections	Grey	ZK2.5-3P	1SNK705011R0000	50	7.40
	Blue	ZK2.5-3P-BL	1SNK705021R0000	50	7.40
	Orange	ZK2.5-3P-OR	1SNK705031R0000	50	7.40
	Yellow	ZK2.5-3P-YL	1SNK705067R0000	50	7.40
	Green	ZK2.5-3P-GN	1SNK705068R0000	50	7.40
	Red	ZK2.5-3P-RD	1SNK705069R0000	50	7.40
	White	ZK2.5-3P-WH	1SNK705072R0000	50	7.40
	Black	ZK2.5-3P-BK	1SNK705073R0000	50	7.40

Main technical data

Connecting capacity		IEC	UL - CSA	Rail	
1 conductor per clamp	Rigid: Solid/Stranded	0.2 ... 4 mm ²	26 ... 12 AWG	Wire stripping length	TH 35-7.5, TH 35-15 11 mm 0.433 in
	Flexible without ferrule	0.22 ... 2.5 mm ²			
	Flexible with non insulated ferrule	0.22 ... 2.5 mm ²	26 ... 14 AWG		
	Flexible with insulated ferrule	0.22 ... 2.5 mm ²	26 ... 14 AWG		
2 conductors per clamp	Flexible with twin ferrule	0.22 ... 0.5 mm ²	26 ... 20 AWG	Tool (for flexible conductor without ferrule)	Flat screwdriver Ø 3.5 mm Ø 0.138 in
Rated current / Rated cross section		24 A / 2.5 mm ²	20 A / 12 AWG		
Rated short-time withstand current (1s)		300 A	396 A		
Short Circuit Current Rating (with specific conditions)			100 kA		
Rated voltage		1000 V	600 V		
Impulse withstand voltage		8000 V			
Protection		IP20	NEMA 1		
Increased safety Ex e		693 V 21 A IEC/EN 60079-7 - IM2 II 2 GD Ex eb IIC/IIC			

The connecting capacity data for one Rigid: Solid/Stranded, or one Flexible conductor (when applicable) is a mandatory information required by IEC, UL and CSA standards (Copper conductors). All other data are provided as supplementary information only. For more details, please consult our CB, UL or CSA certificates and technical datasheet available on <http://www.TE.com>



Accessories

Description	Color	Type	Part Number	Pkg qty	Weight (1 pce) g	
1 End stops	Dark grey	BAZ1	1SNK900002R0000	50	5.30	
2 End sections	Dark grey	EK2.5-3P	1SNK705911R0000	20	2.40	
3 Jumper bars	Orange	2 poles	JB5-2	1SNK905302R0000	50	1.30
		3 poles	JB5-3	1SNK905303R0000	50	2.00
		4 poles	JB5-4	1SNK905304R0000	50	2.70
		5 poles	JB5-5	1SNK905305R0000	50	3.50
		10 poles	JB5-10	1SNK905310R0000	30	7.10
4 Cross spacing jumpers	Orange	3 poles	JB85-3	1SNK900603R0000	10	2.80
		5 poles	JB85-5	1SNK900605R0000	10	3.50
5 Circuit separators	Dark grey	CS-R3	1SNK900107R0000	20	6.40	
6 Test adapters	Dark grey	For test plugs DIA 2 mm 0.079 in	TP2	1SNK900203R0000	20	1.70
		For test plugs DIA 4 mm 0.157 in	TP4	1SNK900205R0000	20	2.40
7 Test connectors	Dark grey	5.2 mm 0.205 in spacing	TC5	1SNK900200R0000	10	5.20
		End module, 5.2 mm 0.205 in	TC5-R1	1SNK900201R0000	10	5.20
		Blank marker	White	MG-CPM 13 41790	1SNB041790R0512	1960
8 Terminal block markers	White	Blank card	MC512	1SNK140000R0000	22	9.00
			MC512PA	1SNK149999R0000	20	10.00
		Universal wire markers holder	Grey	UMH	1SNK900611R0000	10

Complete list of accessories is indicated in the terminal block datasheet including end stops. Some accessories such as jumper bars may modify the terminal block's ratings: Complete information available in the accessories section of the catalog.



Ground PI-Spring terminal blocks

Description	Color	Type	Part Number	Pkg qty	Weight (1 pce) g
Ground	Green-yellow	ZK2.5-PE-3P	1SNK705151R0000	20	11.90

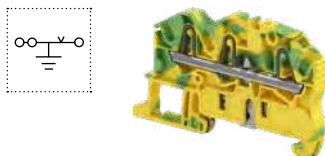

Technical data valid for copper conductors only.

ZK2.5-4P PI-Spring terminal blocks

Feed-through with 4 connections - 5.2 mm 0.205 in spacing

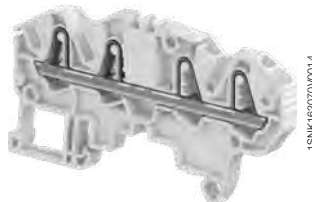

ZK2.5-4P

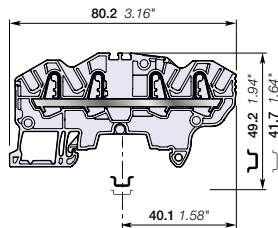

5.2 mm 0.205 in spacing

Description

Find all the features of the ZK2.5 terminal block with the added option of distributing or branching 4 conductors.

Ordering details

Description	Color	Type	Part Number	Pkg qty	Weight (1 pce) g
Feed-through 4 connections	Grey	ZK2.5-4P	1SNK705012R0000	50	9.00
	Blue	ZK2.5-4P-BL	1SNK705022R0000	50	9.00
	Orange	ZK2.5-4P-OR	1SNK705032R0000	50	9.00
	Yellow	ZK2.5-4P-YL	1SNK705074R0000	50	9.00
	Green	ZK2.5-4P-GN	1SNK705075R0000	50	9.00
	Red	ZK2.5-4P-RD	1SNK705076R0000	50	9.00
	White	ZK2.5-4P-WH	1SNK705079R0000	50	9.00
	Black	ZK2.5-4P-BK	1SNK705080R0000	50	9.00

Main technical data

Connecting capacity	IEC	UL - CSA	Mounting instructions
1 conductor per clamp	Rigid: Solid/Stranded Flexible without ferrule Flexible with non insulated ferrule Flexible with insulated ferrule	0.2 ... 4 mm ² 0.22 ... 2.5 mm ² 0.22 ... 2.5 mm ² 0.22 ... 2.5 mm ²	26 ... 12 AWG 26 ... 14 AWG 26 ... 14 AWG
2 conductors per clamp	Flexible with twin ferrule	0.22 ... 0.5 mm ²	26 ... 20 AWG
Rated current / Rated cross section	24 A / 2.5 mm ²	20 A / 12 AWG	
Rated short-time withstand current (1s)	300 A	396 A	
Short Circuit Current Rating (with specific conditions)		100 kA	
Rated voltage	1000 V	600 V	
Impulse withstand voltage	8000 V		
Protection	IP20	NEMA 1	
Increased safety Ex e	693 V 21 A IEC/EN 60079-7 - IM2 II 2 GD Ex eb I/IC/IIIC		

The connecting capacity data for one Rigid: Solid/Stranded, or one Flexible conductor (when applicable) is a mandatory information required by IEC, UL and CSA standards (Copper conductors). All other data are provided as supplementary information only. For more details, please consult our CB, UL or CSA certificates and technical datasheet available on <http://www.TE.com>

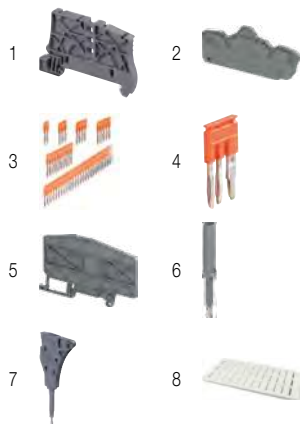

Accessories

Description	Color	Type	Part Number	Pkg qty	Weight (1 pce) g
1 End stops	Dark grey	BAZ1	1SNK900002R0000	50	5.30
2 End sections	Dark grey	EK2.5-4P	1SNK705912R0000	20	2.70
3 Jumper bars	Orange	JB5-2 JB5-3 JB5-4 JB5-5 JB5-10 JB5-50	1SNK905302R0000 1SNK905303R0000 1SNK905304R0000 1SNK905305R0000 1SNK905310R0000 1SNK905350R0000	50 50 50 50 30 10	1.30 2.00 2.70 3.50 7.10 36.00
4 Cross spacing jumpers	Orange	JB85-3	1SNK900603R0000	10	2.80
5 Circuit separators	Dark grey	CS-R3	1SNK900107R0000	20	6.40
6 Test adapters	Dark grey	TP2 TP4	1SNK900203R0000 1SNK900205R0000	20 20	1.70 2.40
7 Test connectors	Dark grey	TC5 TC5-R1	1SNK900200R0000 1SNK900201R0000	10 10	5.20 5.20
8 Terminal block markers	White	MG-CPM 13 41790 MC512 MC512PA	1SNB041790R0512 1SNK140000R0000 1SNK149999R0000	1960 22 20	0.23 9.00 10.00
	Grey	UMH	1SNK900611R0000	10	0.20

Complete list of accessories is indicated in the terminal block datasheet including end stops. Some accessories such as jumper bars may modify the terminal block's ratings: Complete information available in the accessories section of the catalog.

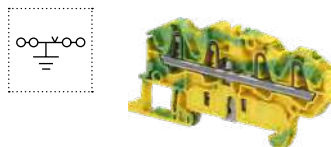

Ground PI-Spring terminal blocks

Description	Color	Type	Part Number	Pkg qty	Weight (1 pce) g
Ground Profile aligned with ZK2.5-4P	Green-yellow	ZK2.5-PE-4P	1SNK705152R0000	20	13.60

Technical data valid for copper conductors only.

ZK4 PI-Spring terminal blocks

Feed-through - 6 mm 0.236 in spacing



ZK4

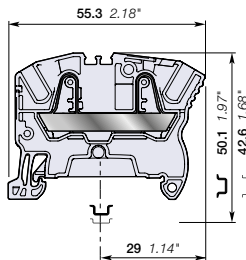

6 mm 0.236 in spacing

Description

Combine high performance with compact dimensions:

- 1000 V AC / DC IEC 600 V UL,
- Opt for the best marking visibility thanks to the up-front, flat marker zone, which lets you mark up to eight digits or increase the font size.

Ordering details

Description	Color	Type	Part Number	Pkg qty	Weight (1 pce) g
Feed-through 2 connections	Grey	ZK4	1SNK706010R0000	50	7.90
	Blue	ZK4-BL	1SNK706020R0000	50	7.90
	Orange	ZK4-OR	1SNK706030R0000	50	7.90
	Yellow	ZK4-YL	1SNK706060R0000	50	7.90
	Red	ZK4-RD	1SNK706062R0000	50	7.90
	Black	ZK4-BK	1SNK706066R0000	50	7.90

Main technical data

Connecting capacity		IEC	UL - CSA	Mounting instructions	
1 conductor per clamp	Rigid: Solid/Stranded	0.5 ... 6 mm ²	26 ... 10 AWG	Rail	TH 35-7.5, TH 35-15
	Flexible without ferrule	0.5 ... 4 mm ²		Wire stripping length	12.5 mm 0.492 in
	Flexible with non insulated ferrule	0.5 ... 4 mm ²	26 ... 12 AWG	Tool (for flexible conductor without ferrule)	Flat screwdriver Ø 3.5 mm Ø 0.138 in
	Flexible with insulated ferrule	0.5 ... 4 mm ²	26 ... 12 AWG		
2 conductors per clamp	Flexible with twin ferrule	0.5 ... 1 mm ²	26 ... 18 AWG		
Rated current / Rated cross section		32 A / 4 mm ²	30 A / 10 AWG		
Rated short-time withstand current (1s)		480 A	636 A		
Short Circuit Current Rating (with specific conditions)			100 kA		
Rated voltage		1000 V	600 V		
Impulse withstand voltage		8000 V			
Protection		IP20	NEMA 1		
Increased safety Ex e		693 V 29 A IEC/EN 60079-7 - IM2 II 2 GD Ex eb IIC/IIC			

The connecting capacity data for one Rigid: Solid/Stranded, or one Flexible conductor (when applicable) is a mandatory information required by IEC, UL and CSA standards (Copper conductors). All other data are provided as supplementary information only. For more details, please consult our CB, UL or CSA certificates and technical datasheet available on <http://www.te.com>



Accessories

Description	Color	Type	Part Number	Pkg qty	Weight (1 pce) g	
1 End stops	Dark grey	BAZ1	1SNK900002R0000	50	5.30	
2 End sections	Dark grey	EK2.5	1SNK705910R0000	20	1.80	
3 Jumper bars	Orange	2 poles	JB6-2	1SNK906302R0000	50	1.30
		3 poles	JB6-3	1SNK906303R0000	50	2.10
		4 poles	JB6-4	1SNK906304R0000	50	2.90
		5 poles	JB6-5	1SNK906305R0000	50	3.60
		10 poles	JB6-10	1SNK906310R0000	20	7.40
4 Cross spacing jumpers	Orange	3 poles	JB6-50	1SNK906350R0000	10	38.10
		3 poles	JB85-3	1SNK900603R0000	10	2.80
5 Circuit separators	Dark grey	CS-R2	1SNK900106R0000	20	3.80	
6 Test adapters	Dark grey	For test plugs DIA 2 mm 0.079 in	TP2	1SNK900203R0000	20	1.70
		For test plugs DIA 4 mm 0.157 in	TP4	1SNK900205R0000	20	2.40
7 Test connectors	Dark grey	TC5-R1	1SNK900201R0000	10	5.20	
8 Spacers	Dark grey	ES-TC6	1SNK900105R0000	10	0.80	
9 Terminal block markers	White	Blank marker	MG-CPM 13 41791	1SNB041791R0612	1680	0.27
		Blank card	MC612	1SNK150000R0000	22	10.00
		Universal wire markers holder	MC612PA	1SNK159999R0000	20	11.00
	Grey	UMH	1SNK900611R0000	10	0.20	

Complete list of accessories is indicated in the terminal block datasheet including end stops. Some accessories such as jumper bars may modify the terminal block's ratings: Complete information available in the accessories section of the catalog.



Ground PI-Spring terminal blocks

Description	Color	Type	Part Number	Pkg qty	Weight (1 pce) g
Ground Profile aligned with ZK4	Green-yellow	ZK4-PE	1SNK706150R0000	20	12.60

Technical data valid for copper conductors only.

ZK4-3P PI-Spring terminal blocks

Feed-through with 3 connections - 6 mm 0.236 in spacing



ZK4-3P

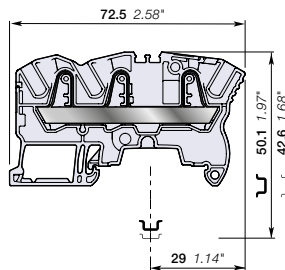

6 mm 0.236 in spacing

Description

Find all the features of the ZK4 terminal block with the added option of distributing or branching 3 conductors.

Ordering details

Description	Color	Type	Part Number	Pkg qty	Weight (1 pce) g
Feed-through 3 connections	Grey	ZK4-3P	1SNK706011R0000	50	11.00
	Blue	ZK4-3P-BL	1SNK706021R0000	50	11.00
	Orange	ZK4-3P-OR	1SNK706031R0000	50	11.00

Main technical data

Connecting capacity		IEC	UL - CSA	Mounting instructions	
1 conductor per clamp	Rigid: Solid/Stranded	0.5 ... 6 mm²	26 ... 10 AWG	Rail	TH 35-7.5, TH 35-15
	Flexible without ferrule	0.5 ... 4 mm²		Wire stripping length	12.5 mm 0.492 in
	Flexible with non insulated ferrule	0.5 ... 4 mm²	26 ... 12 AWG		
	Flexible with insulated ferrule	0.5 ... 4 mm²	26 ... 12 AWG		
2 conductors per clamp	Flexible with twin ferrule	0.5 ... 1 mm²	26 ... 18 AWG	Tool (for flexible conductor without ferrule)	Flat screwdriver Ø 3.5 mm Ø 0.138 in
Rated current / Rated cross section		32 A / 4 mm²	30 A / 10 AWG		
Rated short-time withstand current (1s)		480 A	636 A		
Short Circuit Current Rating (with specific conditions)			100 kA		
Rated voltage		1000 V	600 V		
Impulse withstand voltage		8000 V			
Protection		IP20	NEMA 1		
Increased safety Ex e		693 V 29 A IEC/EN 60079-7 - IM2 II 2 GD Ex eb I/IIc/IIIC			

The connecting capacity data for one Rigid: Solid/Stranded, or one Flexible conductor (when applicable) is a mandatory information required by IEC, UL and CSA standards (Copper conductors). All other data are provided as supplementary information only. For more details, please consult our CB, UL or CSA certificates and technical datasheet available on <http://www.TE.com>

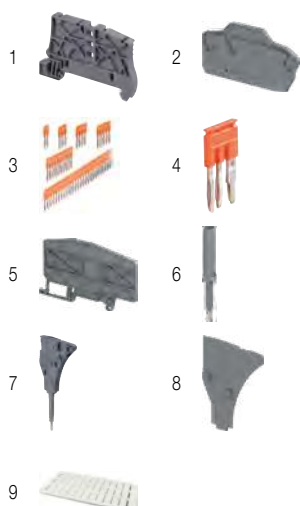

Accessories

Description	Color	Type	Part Number	Pkg qty	Weight (1 pce) g	
1 End stops	Dark grey	BAZ1	1SNK900002R0000	50	5.30	
2 End sections	Dark grey	EK2.5-3P	1SNK705911R0000	20	2.40	
3 Jumper bars	Orange	2 poles	JB6-2	1SNK906302R0000	50	1.30
		3 poles	JB6-3	1SNK906303R0000	50	2.10
		4 poles	JB6-4	1SNK906304R0000	50	2.90
		5 poles	JB6-5	1SNK906305R0000	50	3.60
		10 poles	JB6-10	1SNK906310R0000	20	7.40
		50 poles	JB6-50	1SNK906350R0000	10	38.10
4 Cross spacing jumpers	Orange	JB85-3	1SNK900603R0000	10	2.80	
5 Circuit separators	Dark grey	3 mm	CS-R3	1SNK900107R0000	20	6.40
		0.118 in				
6 Test adapters	Dark grey	For test plugs DIA 2 mm 0.079 in	TP2	1SNK900203R0000	20	1.70
		For test plugs DIA 4 mm 0.157 in	TP4	1SNK900205R0000	20	2.40
7 Test connectors	Dark grey	TC5-R1	1SNK900201R0000	10	5.20	
8 Spacers	Dark grey	0.8 mm	ES-TC6	1SNK900105R0000	10	0.80
		0.031 in				
9 Terminal block markers	White	Blank marker	MG-CPM 13 41791	1SNB041791R0612	1680	0.27
		Blank card	MC612	1SNK150000R0000	22	10.00
			MC612PA	1SNK159999R0000	20	11.00
	Universal wire markers holder	Grey	UMH	1SNK900611R0000	10	0.20

Complete list of accessories is indicated in the terminal block datasheet including end stops. Some accessories such as jumper bars may modify the terminal block's ratings: Complete information available in the accessories section of the catalog.



Ground PI-Spring terminal blocks

Description	Color	Type	Part Number	Pkg qty	Weight (1 pce) g
Ground	Green-yellow	ZK4-PE-3P	1SNK706151R0000	20	15.70

Technical data valid for copper conductors only.

ZK4-4P PI-Spring terminal blocks

Feed-through with 4 connections - 6 mm 0.236 in spacing

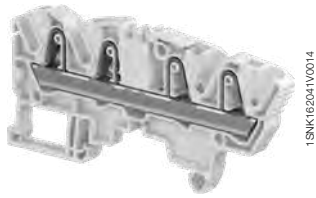

ZK4-4P

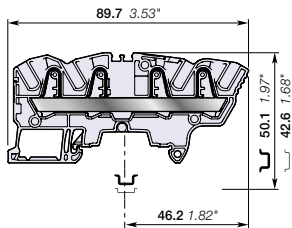

6 mm 0.236 in spacing

Description

Find all the features of the ZK4 terminal block with the added option of distributing or branching 4 conductors.

Ordering details

Description	Color	Type	Part Number	Pkg qty	Weight (1 pce) g
Feed-through 4 connections	Grey	ZK4-4P	1SNK706012R0000	50	13.80
	Blue	ZK4-4P-BL	1SNK706022R0000	50	13.80
	Orange	ZK4-4P-OR	1SNK706032R0000	50	13.80

Main technical data

Connecting capacity		IEC	UL - CSA	Mounting instructions	
1 conductor per clamp	Rigid: Solid/Stranded	0.5 ... 6 mm ²	26 ... 10 AWG	Rail	TH 35-7.5, TH 35-15
	Flexible without ferrule	0.5 ... 4 mm ²		Wire stripping length	12.5 mm 0.492 in
	Flexible with non insulated ferrule	0.5 ... 4 mm ²	26 ... 12 AWG		
	Flexible with insulated ferrule	0.5 ... 4 mm ²	26 ... 12 AWG		
2 conductors per clamp	Flexible with twin ferrule	0.5 ... 1 mm ²	26 ... 18 AWG	Tool (for flexible conductor without ferrule)	Flat screwdriver Ø 3.5 mm Ø 0.138 in
Rated current / Rated cross section		32 A / 4 mm ²	30 A / 10 AWG		
Rated short-time withstand current (1s)		480 A	636 A		
Short Circuit Current Rating (with specific conditions)			100 kA		
Rated voltage		1000 V	600 V		
Impulse withstand voltage		8000 V			
Protection		IP20	NEMA 1		
Increased safety Ex e		693 V 29 A IEC/EN 60079-7 - IM2 II 2 GD Ex eb I/IC/IIIC			

The connecting capacity data for one Rigid: Solid/Stranded, or one Flexible conductor (when applicable) is a mandatory information required by IEC, UL and CSA standards (Copper conductors). All other data are provided as supplementary information only. For more details, please consult our CB, UL or CSA certificates and technical datasheet available on <http://www.TE.com>

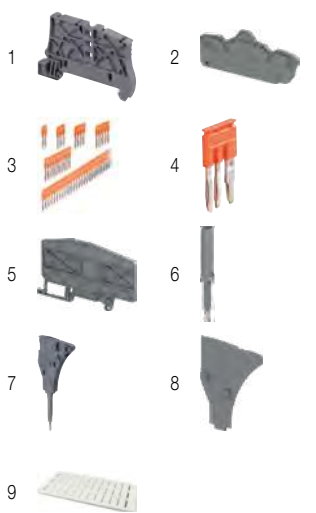

Accessories

Description	Color	Type	Part Number	Pkg qty	Weight (1 pce) g	
1 End stops	Dark grey	BAZ1	1SNK900002R0000	50	5.30	
2 End sections	Dark grey	EK2.5-4P	1SNK705912R0000	20	2.70	
3 Jumper bars	Orange	2 poles	JB6-2	1SNK906302R0000	50	1.30
		3 poles	JB6-3	1SNK906303R0000	50	2.10
		4 poles	JB6-4	1SNK906304R0000	50	2.90
		5 poles	JB6-5	1SNK906305R0000	50	3.60
		10 poles	JB6-10	1SNK906310R0000	20	7.40
		50 poles	JB6-50	1SNK906350R0000	10	38.10
4 Cross spacing jumpers	Orange	JB85-3	1SNK900603R0000	10	2.80	
5 Circuit separators	Dark grey	CS-R3	1SNK900107R0000	20	6.40	
6 Test adapters	Dark grey	For test plugs DIA 2 mm 0.079 in	TP2	1SNK900203R0000	20	1.70
		For test plugs DIA 4 mm 0.157 in	TP4	1SNK900205R0000	20	2.40
7 Test connectors	Dark grey	TC5-R1	1SNK900201R0000	10	5.20	
8 Spacers	Dark grey	ES-TC6	1SNK900105R0000	10	0.80	
9 Terminal block markers	White	Blank marker	MG-CPM 13 41791	1SNB041791R0612	1680	0.27
		Blank card	MC612	1SNK150000R0000	22	10.00
		Universal wire markers holder	MC612PA	1SNK159999R0000	20	11.00
	Grey	UMH	1SNK900611R0000	10	0.20	

Complete list of accessories is indicated in the terminal block datasheet including end stops. Some accessories such as jumper bars may modify the terminal block's ratings: Complete information available in the accessories section of the catalog.



Ground PI-Spring terminal blocks

Description	Color	Type	Part Number	Pkg qty	Weight (1 pce) g
Ground	Green-yellow	ZK4-PE-4P	1SNK706152R0000	20	18.40

Technical data valid for copper conductors only.

ZK6 PI-Spring terminal blocks

Feed-through - 8 mm 0.315 in spacing



ZK6

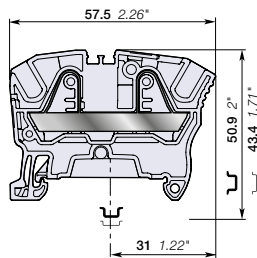

8 mm 0.315 in spacing

Description

Combine high performance with compact dimensions:

- 1000 V AC / DC IEC 600 V UL,
- Opt for the best marking visibility thanks to the up-front, flat marker zone, which lets you mark up to eight digits or increase the font size.

Ordering details

Description	Color	Type	Part Number	Pkg qty	Weight (1 pce) g
Feed-through 2 connections	Grey	ZK6	1SNK708010R0000	50	11.80
	Blue	ZK6-BL	1SNK708020R0000	50	11.80
	Orange	ZK6-OR	1SNK708030R0000	50	11.80
	Yellow	ZK6-YL	1SNK708060R0000	50	11.80
	Red	ZK6-RD	1SNK708062R0000	50	11.80
	Black	ZK6-BK	1SNK708066R0000	50	11.80

Main technical data

Connecting capacity	IEC	UL - CSA	Mounting instructions
1 conductor per clamp	Rigid: Solid/Stranded	0.5 ... 10 mm²	24 ... 8 AWG
	Flexible without ferrule	0.5 ... 6 mm²	24 ... 10 AWG
	Flexible with non insulated ferrule	0.5 ... 6 mm²	24 ... 10 AWG
	Flexible with insulated ferrule	0.5 ... 6 mm²	24 ... 10 AWG
2 conductors per clamp	Flexible with twin ferrule	0.5 ... 1.5 mm²	24 ... 16 AWG
Rated current / Rated cross section	41 A / 6 mm²	50 A / 8 AWG	
Rated short-time withstand current (1s)	720 A	1008 A	
Short Circuit Current Rating (with specific conditions)		100 kA	
Rated voltage	1000 V	600 V	
Impulse withstand voltage	8000 V		
Protection	IP20	NEMA 1	

Increased safety Ex e

693 V 37 A IEC/EN 60079-7 - IM2 II 2 GD Ex eb I/II/III/C

The connecting capacity data for one Rigid: Solid/Stranded, or one Flexible conductor (when applicable) is a mandatory information required by IEC, UL and CSA standards (Copper conductors). All other data are provided as supplementary information only. For more details, please consult our CB, UL or CSA certificates and technical datasheet available on <http://www.TE.com>



Accessories

Description	Color	Type	Part Number	Pkg qty	Weight (1 pce) g	
1 End stops	Dark grey	BAZ1	1SNK900002R0000	50	5.30	
2 End sections	Dark grey	EK2.5	1SNK705910R0000	20	1.80	
3 Jumper bars	Orange	2 poles	JB8-2	1SNK908302R0000	50	2.70
		3 poles	JB8-3	1SNK908303R0000	50	4.10
		4 poles	JB8-4	1SNK908304R0000	50	5.60
		5 poles	JB8-5	1SNK908305R0000	40	7.00
		10 poles	JB8-10	1SNK908310R0000	20	14.20
4 Cross spacing jumpers	Orange	JB85-3	1SNK900603R0000	10	2.80	
5 Circuit separators	Dark grey	CS-R2	1SNK900106R0000	20	3.80	
6 Test adapters	Dark grey	For test plugs DIA 2 mm 0.079 in	TP2	1SNK900203R0000	20	1.70
		For test plugs DIA 4 mm 0.157 in	TP4	1SNK900205R0000	20	2.40
7 Test connectors	Dark grey	TC5-R1	1SNK900201R0000	10	5.20	
8 Spacers	Dark grey	2.8 mm	ES-TC8	1SNK900104R0000	10	1.40
		0.110 in				
9 Terminal block markers	White	Blank marker	MG-CPM 13 41791	1SNB041791R0612	1680	0.27
		Blank card	MC812	1SNK160000R0000	22	10.00
			MC812PA	1SNK169999R0000	20	14.00
		Universal wire markers holder	UMH	1SNK900611R0000	10	0.20

Complete list of accessories is indicated in the terminal block datasheet including end stops.

Some accessories such as jumper bars may modify the terminal block's ratings: Complete information available in the accessories section of the catalog.



Ground PI-Spring terminal blocks

Description	Color	Type	Part Number	Pkg qty	Weight (1 pce) g
Ground	Green-yellow	ZK6-PE	1SNK708150R0000	20	20.30

Technical data valid for copper conductors only.



ZK6-3P PI-Spring terminal blocks

Feed-through with 3 connections - 8 mm 0.315 in spacing

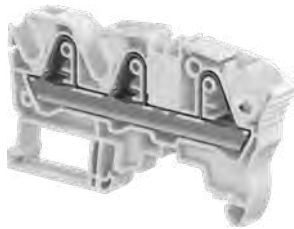

1SNK162019/0014

ZK6-3P

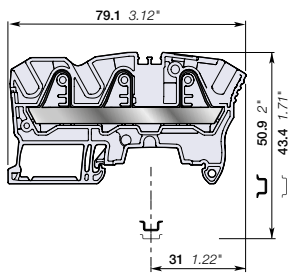

8 mm 0.315 in spacing

Description

Find all the features of the ZK6 terminal block with the added option of distributing or branching 3 conductors.

Ordering details

Description	Color	Type	Part Number	Pkg qty	Weight (1 pce) g
Feed-through 3 connections	Grey	ZK6-3P	1SNK708011R0000	50	16.70
	Blue	ZK6-3P-BL	1SNK708021R0000	50	16.70
	Orange	ZK6-3P-OR	1SNK708031R0000	50	16.70

Main technical data

Connecting capacity		IEC	UL - CSA	Mounting instructions	
1 conductor per clamp	Rigid: Solid/Stranded	0.5 ... 10 mm ²	24 ... 8 AWG	Rail	TH 35-7.5, TH 35-15
	Flexible without ferrule	0.5 ... 6 mm ²		Wire stripping length	12.5 mm 0.492 in
	Flexible with non insulated ferrule	0.5 ... 6 mm ²	24 ... 10 AWG	Tool (for flexible conductor without ferrule)	Flat screwdriver Ø 3.5 mm Ø 0.138 in
	Flexible with insulated ferrule	0.5 ... 6 mm ²	24 ... 10 AWG		
2 conductors per clamp	Flexible with twin ferrule	0.5 ... 1.5 mm ²	24 ... 16 AWG		
Rated current / Rated cross section		41 A / 6 mm ²	50 A / 8 AWG		
Rated short-time withstand current (1s)		720 A	1008 A		
Short Circuit Current Rating (with specific conditions)			100 kA		
Rated voltage		1000 V	600 V		
Impulse withstand voltage		8000 V			
Protection		IP20	NEMA 1		
Increased safety Ex e		693 V 37 A IEC/EN 60079-7 - IM2 II 2 GD Ex eb I/IC/IIIC			

The connecting capacity data for one Rigid: Solid/Stranded, or one Flexible conductor (when applicable) is a mandatory information required by IEC, UL and CSA standards (Copper conductors). All other data are provided as supplementary information only. For more details, please consult our CB, UL or CSA certificates and technical datasheet available on <http://www.TE.com>



Accessories

Description	Color	Type	Part Number	Pkg qty	Weight (1 pce) g	
1 End stops	Dark grey	BAZ1	1SNK900002R0000	50	5.30	
2 End sections	Dark grey	EK6-3P	1SNK708911R0000	20	2.80	
3 Jumper bars	Orange	2 poles	JB8-2	1SNK908302R0000	50	2.70
		3 poles	JB8-3	1SNK908303R0000	50	4.10
		4 poles	JB8-4	1SNK908304R0000	50	5.60
		5 poles	JB8-5	1SNK908305R0000	40	7.00
		10 poles	JB8-10	1SNK908310R0000	20	14.20
4 Cross spacing jumpers	Orange	JB85-3	1SNK900603R0000	10	2.80	
5 Circuit separators	Dark grey	CS-R3	1SNK900107R0000	20	6.40	
6 Test adapters	Dark grey	For test plugs DIA 2 mm 0.079 in	TP2	1SNK900203R0000	20	1.70
		For test plugs DIA 4 mm 0.157 in	TP4	1SNK900205R0000	20	2.40
7 Test connectors	Dark grey	TC5-R1	1SNK900201R0000	10	5.20	
8 Spacers	Dark grey	ES-TC8	1SNK900104R0000	10	1.40	
		MG-CPM 13 41791	1SNB041791R0612	1680	0.27	
		MC812	1SNK160000R0000	22	10.00	
9 Terminal block markers	White	Blank card	MC812PA	1SNK169999R0000	20	14.00
		Universal wire markers holder	UMH	1SNK900611R0000	10	0.20

Complete list of accessories is indicated in the terminal block datasheet including end stops. Some accessories such as jumper bars may modify the terminal block's ratings. Complete information available in the accessories section of the catalog.

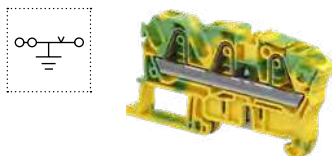
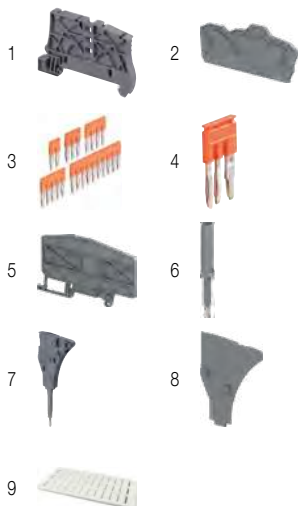

Ground PI-Spring terminal blocks

Description	Color	Type	Part Number	Pkg qty	Weight (1 pce) g
Ground	Green-yellow	ZK6-PE-3P	1SNK708151R0000	20	21.50

Technical data valid for copper conductors only.

ZK10 PI-Spring terminal blocks

Feed-through - 10 mm 0.394 in spacing

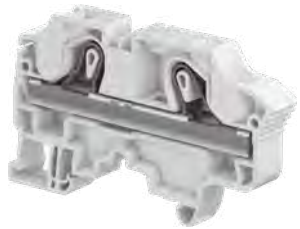

ZK10

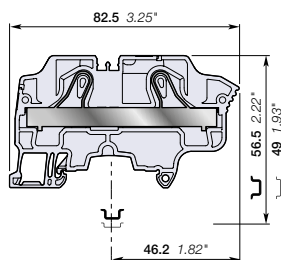

10 mm 0.394 in spacing

Description

Combine high performance with compact dimensions:

- 1000 V AC / DC IEC 600 V UL,
- Opt for the best marking visibility thanks to the up-front, flat marker zone, which lets you mark up to eight digits or increase the font size.

Ordering details

Description	Color	Type	Part Number	Pkg qty	Weight (1 pce) g
Feed-through 2 connections	Grey <input type="checkbox"/>	ZK10	1SNK710010R0000	20	27.20
	Blue <input type="checkbox"/>	ZK10-BL	1SNK710020R0000	20	27.20
	Orange <input type="checkbox"/>	ZK10-OR	1SNK710030R0000	20	27.20

Main technical data

Connecting capacity	IEC	UL - CSA	Mounting instructions
1 conductor per clamp	Rigid: Solid/Stranded	0.5 ... 16 mm ²	20 ... 6 AWG
	Flexible without ferrule	0.5 ... 10 mm ²	20 ... 8 AWG
	Flexible with non insulated ferrule	0.5 ... 10 mm ²	20 ... 8 AWG
	Flexible with insulated ferrule	0.5 ... 10 mm ²	20 ... 8 AWG
2 conductors per clamp	Flexible with twin ferrule	0.5 ... 4 mm ²	20 ... 12 AWG
Rated current / Rated cross section		57 A / 10 mm ²	55 A / 6 AWG
Rated short-time withstand current (1s)		1200 A	1596 A
Short Circuit Current Rating (with specific conditions)			100 kA
Rated voltage		1000 V	600 V
Impulse withstand voltage		8000 V	
Protection		IP20	NEMA 1
Increased safety Ex e		693 V 51 A IEC/EN 60079-7 - IM2 II 2 GD Ex eb I/II/C/IIIC	

The connecting capacity data for one Rigid: Solid/Stranded, or one Flexible conductor (when applicable) is a mandatory information required by IEC, UL and CSA standards (Copper conductors). All other data are provided as supplementary information only. For more details, please consult our CB, UL or CSA certificates and technical datasheet available on <http://www.TE.com>



Accessories

Description	Color	Type	Part Number	Pkg qty	Weight (1 pce) g	
1 End stops	Dark grey <input type="checkbox"/>	BAZ1	1SNK900002R0000	50	5.30	
2 End sections	Dark grey <input type="checkbox"/>	EK10	1SNK710910R0000	20	3.30	
3 Jumper bars	Orange <input type="checkbox"/>	2 poles	JB10-2	1SNK910302R0000	50	4.60
		3 poles	JB10-3	1SNK910303R0000	50	7.10
		4 poles	JB10-4	1SNK910304R0000	40	9.40
		5 poles	JB10-5	1SNK910305R0000	30	12.00
		10 poles	JB10-10	1SNK910310R0000	20	24.00
4 Circuit separators	Dark grey <input type="checkbox"/>	CS-R3	1SNK900107R0000	20	6.40	
5 Test adapters	Dark grey <input type="checkbox"/>	For test plugs DIA 2 mm 0.079 in	TP2	1SNK900203R0000	20	1.70
		For test plugs DIA 4 mm 0.157 in	TP4	1SNK900205R0000	20	2.40
6 Terminal block markers	White <input type="checkbox"/>	Blank marker	MG-CPM 13 41791	1SNB041791R0612	1680	0.27
		Blank card	MC812	1SNK160000R0000	22	10.00
			MC812PA	1SNK169999R0000	20	14.00
	Universal wire markers holder	Grey <input type="checkbox"/>	UMH	1SNK900611R0000	10	0.20

Complete list of accessories is indicated in the terminal block datasheet including end stops.

Some accessories such as jumper bars may modify the terminal block's ratings: Complete information available in the accessories section of the catalog.

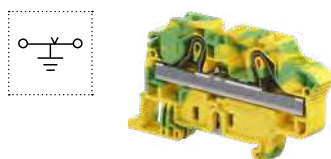

Ground PI-Spring terminal blocks

Description	Color	Type	Part Number	Pkg qty	Weight (1 pce) g
Ground	Green-yellow <input type="checkbox"/>	ZK10-PE	1SNK710150R0000	20	36.20

Technical data valid for copper conductors only.

ZK10-PV PI-Spring terminal blocks

Feed-through - 12 mm 0.472 in spacing

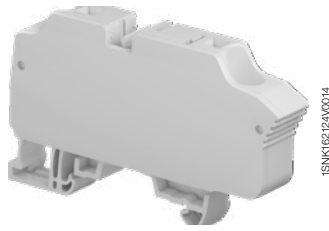

Description

- Specially designed for high voltage utility scale solar power plants:
- Rated voltage of 1500 V DC IEC and 1000 V DC UL,
 - Pre-mounted end section with light grey color specific to this application,
 - Improved design with ribs to increase creepage distance,
 - Compact solution only 2 mm thicker than normal product,
 - Compatible with JB12 jumpers to interconnect multiple terminal blocks.

Ordering details

Description	Color	Type	Part Number	Pkg qty	Weight (1 pce) g
Feed-through 2 connections	Grey	ZK10-PV	1SNK710063R0000	20	29.86
	Blue	ZK10-PV-BL	1SNK710065R0000	20	29.86

Main technical data

Connecting capacity	IEC	UL - CSA	Mounting instructions
1 conductor per clamp	Rigid: Solid/Stranded	0.5 ... 16 mm ²	Rail
	Flexible without ferrule	0.5 ... 10 mm ²	Wire stripping length
	Flexible with non insulated ferrule	0.5 ... 10 mm ²	Tool (for flexible conductor without ferrule)
	Flexible with insulated ferrule	0.5 ... 10 mm ²	
2 conductors per clamp	Flexible with twin ferrule	0.5 ... 4 AWG	
Rated current / Rated cross section		57 A / 10 mm ²	
Rated short-time withstand current (1s)		1200 A	
Short Circuit Current Rating (with specific conditions)		100 kA	
Rated voltage		1000 V AC / 1500 V DC	
Impulse withstand voltage		8000 V	
Protection		IP20	

ZK10-PV

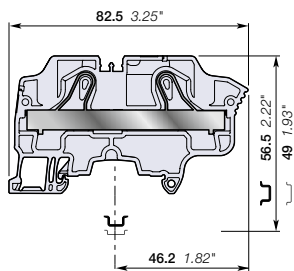

12 mm 0.472 in spacing

The connecting capacity data for one Rigid: Solid/Stranded, or one Flexible conductor (when applicable) is a mandatory information required by IEC, UL and CSA standards (Copper conductors). All other data are provided as supplementary information only. For more details, please consult our CB, UL or CSA certificates and technical datasheet available on <http://www.TE.com>



Accessories

Description	Color	Type	Part Number	Pkg qty	Weight (1 pce) g	
1 End stops	Dark grey	BAZ1	1SNK900002R0000	50	5.30	
2 Jumper bars	Orange	2 poles	JB12-2	1SNK912302R0000	50	4.90
		3 poles	JB12-3	1SNK912303R0000	50	7.60
		5 poles	JB12-5	1SNK912305R0000	20	12.90
3 Circuit separators	Dark grey	CS-R3	1SNK900107R0000	20	6.40	
4 Test adapters	Dark grey	For test plugs DIA 2 mm 0.079 in	TP2	1SNK900203R0000	20	1.70
		For test plugs DIA 4 mm 0.157 in	TP4	1SNK900205R0000	20	2.40
5 Terminal block markers	White	Blank card	MC812	1SNK160000R0000	22	10.00
		Blank marker	MC812PA	1SNK169999R0000	20	14.00
	Universal wire markers holder	Grey	UMH	1SNK041791R0612	1680	0.273
			1SNK900611R0000	10	0.20	

Complete list of accessories is indicated in the terminal block datasheet including end stops. Some accessories such as jumper bars may modify the terminal block's ratings: Complete information available in the accessories section of the catalog.

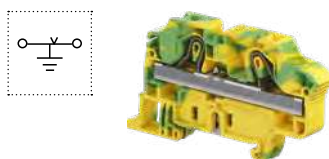

Ground PI-Spring terminal blocks

Description	Color	Type	Part Number	Pkg qty	Weight (1 pce) g
Ground	Green-yellow	ZK10-PE	1SNK710150R0000	20	36.20

Technical data valid for copper conductors only.

ZK10-3P PI-Spring terminal blocks

Feed-through with 3 connections - 10 mm 0.394 in spacing



ZK10-3P

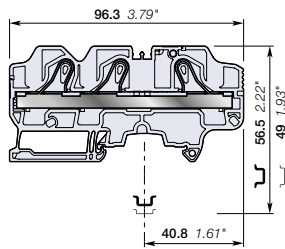

10 mm 0.394 in spacing

Description

- Find all the features of the ZK10 terminal block with the added option of distributing or branching 3 conductors,
- ZK10-3P is perfectly adapted to solar applications: 1250 V DC (1000 V AC) IEC, 1000 V UL.

Ordering details

Description	Color	Type	Part Number	Pkg qty	Weight (1 pce) g
Feed-through 3 connections	Grey <input type="checkbox"/>	ZK10-3P	1SNK710011R0000	20	34.9
	Blue <input type="checkbox"/>	ZK10-3P-BL	1SNK710021R0000	20	34.9

Main technical data

Connecting capacity	IEC	UL - CSA	Rail	Wire stripping length	TH 35-7.5, TH 35-15
1 conductor per clamp	Rigid: Solid/Stranded	0.5 ... 16 mm ²	20 ... 6 AWG	15 mm	0.591 in
	Flexible without ferrule	0.5 ... 10 mm ²			
	Flexible with non insulated ferrule	0.5 ... 10 mm ²	20 ... 8 AWG		
	Flexible with insulated ferrule	0.5 ... 10 mm ²	20 ... 8 AWG		
2 conductors per clamp	Flexible with twin ferrule	0.5 ... 4 mm ²	20 ... 12 AWG	Tool (for flexible conductor without ferrule)	Flat screwdriver Ø 4 mm Ø 0.157 in
Rated current / Rated cross section		57 A / 10 mm ²	56 A / 6 AWG		
Rated short-time withstand current (1s)		1200 A			
Short Circuit Current Rating (with specific conditions)			100 kA		
Rated voltage		1000 V	1000 V		
Impulse withstand voltage		8000 V			
Protection		IP20	NEMA 1		
Increased safety Ex e		693 V 57 A - IM2 II 2 GD Ex eb I/IIIC			

The connecting capacity data for one Rigid: Solid/Stranded, or one Flexible conductor (when applicable) is a mandatory information required by IEC, UL and CSA standards (Copper conductors). All other data are provided as supplementary information only. For more details, please consult our CB, UL or CSA certificates and technical datasheet available on <http://www.TE.com>



Accessories

Description	Color	Type	Part Number	Pkg qty	Weight (1 pce) g	
1 End stops	Dark grey <input checked="" type="checkbox"/>	BAZ1	1SNK900002R0000	50	5.30	
2 End sections	Dark grey <input checked="" type="checkbox"/>	EK10-3P	1SNK710911R0000	20	4.5	
3 Jumper bars	Orange <input checked="" type="checkbox"/>	2 poles	JB10-2	1SNK910302R0000	50	4.60
		3 poles	JB10-3	1SNK910303R0000	50	7.10
		4 poles	JB10-4	1SNK910304R0000	40	9.40
		5 poles	JB10-5	1SNK910305R0000	30	12.00
		10 poles	JB10-10	1SNK910310R0000	20	24.00
4 Test adapters	Dark grey <input checked="" type="checkbox"/>	For test plugs DIA 2 mm 0.079 in	TP2	1SNK900203R0000	20	1.70
		For test plugs DIA 4 mm 0.157 in	TP4	1SNK900205R0000	20	2.40
5 Terminal block markers	White <input type="checkbox"/>	Blank marker	MG-CPM 13 41791	1SNB041791R0612	1680	0.27
		Blank card	MC812	1SNK160000R0000	22	10.00
			MC812PA	1SNK169999R0000	20	14.00
		Universal wire markers holder	Grey <input type="checkbox"/>	UMH	1SNK900611R0000	10

Complete list of accessories is indicated in the terminal block datasheet including end stops. Some accessories such as jumper bars may modify the terminal block's ratings: Complete information available in the accessories section of the catalog.

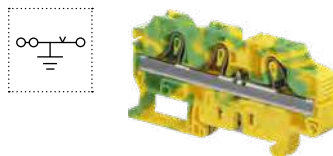

Ground PI-Spring terminal blocks

Description	Color	Type	Part Number	Pkg qty	Weight (1 pce) g
Ground	Green-yellow <input checked="" type="checkbox"/>	ZK10-PE-3P	1SNK710151R0000	20	43.3

Technical data valid for copper conductors only.

ZK10-3P-PV PI-Spring terminal blocks

Feed-through with 3 connections - 12 mm 0.472 in spacing



ZK10-3P-PV

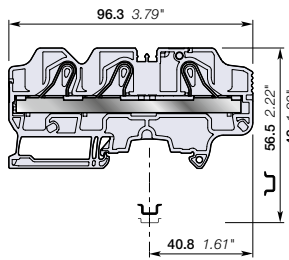

12 mm 0.472 in spacing

Description

Specially designed for high voltage utility scale solar power plants:

- Rated voltage of 1500 V DC IEC and 1000 V DC UL,
- Pre-mounted end section with light grey color specific to this application,
- Improved design with ribs to increase creepage distance,
- Compact solution only 2 mm thicker than normal product,
- 3 connections configuration for easy grouping: 2 inputs / 1 output or 1 input / 2 outputs,
- Compatible with JB12 jumpers to interconnect multiple terminal blocks.

Description	Color	Type	Part Number	Pkg qty	Weight (1 pce) g
Feed-through 3 connections	Grey	ZK10-3P-PV	1SNK710064R0000	20	38.61
	Blue	ZK10-3P-PV-BL	1SNK710067R0000	20	38.61

Main technical data

Connecting capacity		IEC	UL - CSA	Mounting instructions		
1 conductor per clamp	Rigid: Solid/Stranded	0.5 ... 16 mm ²	20 ... 6 AWG	Rail		TH 35-7.5, TH 35-15
	Flexible without ferrule	0.5 ... 10 mm ²	20 ... 8 AWG			
	Flexible with non insulated ferrule	0.5 ... 10 mm ²	20 ... 8 AWG	Wire stripping length		15 mm 0.591 in
	Flexible with insulated ferrule	0.5 ... 10 mm ²	20 ... 8 AWG			
2 conductors per clamp	Flexible with twin ferrule	0.5 ... 4 AWG	20 ... 12 AWG	Tool (for flexible conductor without ferrule)		Flat screwdriver Ø 4 mm Ø 0.157 in
Rated current / Rated cross section		57 A / 10 mm ²	56 A / 6 AWG			
Rated short-time withstand current (1s)		1200 A	1596 A			
Short Circuit Current Rating (with specific conditions)			100 kA			
Rated voltage		1000 V AC / 1500 V DC	1000 V			
Impulse withstand voltage		8000 V				
Protection		IP20	NEMA 1			

The connecting capacity data for one Rigid: Solid/Stranded, or one Flexible conductor (when applicable) is a mandatory information required by IEC, UL and CSA standards (Copper conductors). All other data are provided as supplementary information only. For more details, please consult our CB, UL or CSA certificates and technical datasheet available on <http://www.TE.com>

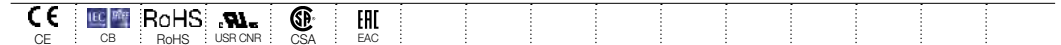

Accessories

Description	Color	Type	Part Number	Pkg qty	Weight (1 pce) g	
1 End stops	Dark grey	BAZ1	1SNK900002R0000	50	5.30	
2 Jumper bars	Orange	2 poles	JB12-2	1SNK912302R0000	50	4.90
		3 poles	JB12-3	1SNK912303R0000	50	7.60
		5 poles	JB12-5	1SNK912305R0000	20	12.90
3 Circuit separators	Dark grey	CS-R3	1SNK900107R0000	20	6.40	
4 Test adapters	Dark grey	For test plugs DIA 2 mm 0.079 in	TP2	1SNK900203R0000	20	1.70
		For test plugs DIA 4 mm 0.157 in	TP4	1SNK900205R0000	20	2.40
5 Terminal block markers	White	Blank card	MC812	1SNK160000R0000	22	10.00
			MC812PA	1SNK169999R0000	20	14.00
	Blank marker		MG-CPM 13 41791	1SNB041791R0612	1680	0.273
Universal wire markers holder	Grey	UMH	1SNK900611R0000	10	0.20	

Complete list of accessories is indicated in the terminal block datasheet including end stops. Some accessories such as jumper bars may modify the terminal block's ratings: Complete information available in the accessories section of the catalog.

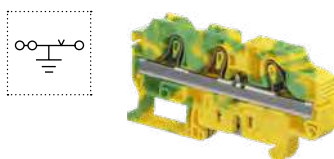

Ground PI-Spring terminal blocks

Description	Color	Type	Part Number	Pkg qty	Weight (1 pce) g
Ground	Green-yellow	ZK10-PE-3P	1SNK710151R0000	20	43.3

Technical data valid for copper conductors only.

ZK16 PI-Spring terminal blocks

Feed-through - 12 mm 0.472 in spacing



ZK16

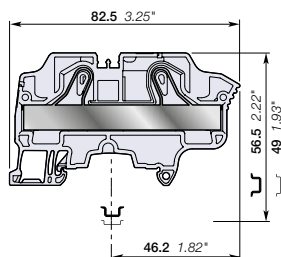

12 mm 0.472 in spacing

Description

Combine high performance with compact dimensions:

- 1000 V AC / DC IEC 600 V UL,
- Opt for the best marking visibility thanks to the up-front, flat marker zone, which lets you mark up to eight digits or increase the font size.

Ordering details

Description	Color	Type	Part Number	Pkg qty	Weight (1 pce) g
Feed-through 2 connections	Grey <input type="checkbox"/>	ZK16	1SNK712010R0000	20	33.80
	Blue <input type="checkbox"/>	ZK16-BL	1SNK712020R0000	20	33.80

Main technical data

Connecting capacity	IEC	UL - CSA	Mounting instructions		
1 conductor per clamp	Rigid: Solid/Stranded	0.5 ... 25 mm ²	20 ... 4 AWG	Rail	 TH 35-7.5, TH 35-15
	Flexible without ferrule	0.5 ... 16 mm ²	20 ... 6 AWG		
	Flexible with non insulated ferrule	0.5 ... 16 mm ²	20 ... 6 AWG	Wire stripping length	 15 mm 0.591 in
	Flexible with insulated ferrule	0.5 ... 16 mm ²	20 ... 6 AWG		
2 conductors per clamp	Flexible with twin ferrule	0.5 ... 6 mm ²	20 ... 10 AWG	Tool (for flexible conductor without ferrule)	 Flat screwdriver Ø 4 mm Ø 0.157 in
Rated current / Rated cross section		76 A / 16 mm ²	75 A / 4 AWG		
Rated short-time withstand current (1s)		1920 A	2544 A		
Short Circuit Current Rating (with specific conditions)			100 kA		
Rated voltage		1000 V	600 V		
Impulse withstand voltage		8000 V			
Protection		IP20	NEMA 1		
Increased safety Ex e		693 V 69 A IEC/EN 60079-7 - IM2 II 2 GD Ex eb I/II/III/C			

The connecting capacity data for one Rigid: Solid/Stranded, or one Flexible conductor (when applicable) is a mandatory information required by IEC, UL and CSA standards (Copper conductors). All other data are provided as supplementary information only. For more details, please consult our CB, UL or CSA certificates and technical datasheet available on <http://www.TE.com>



Accessories

Description	Color	Type	Part Number	Pkg qty	Weight (1 pce) g	
1 End stops	Dark grey <input type="checkbox"/>	BAZ1	1SNK900002R0000	50	5.30	
2 End sections	Dark grey <input type="checkbox"/>	EK10	1SNK710910R0000	20	3.30	
3 Jumper bars	Orange <input type="checkbox"/>	2 poles	JB12-2	1SNK912302R0000	50	4.90
		3 poles	JB12-3	1SNK912303R0000	50	7.60
		5 poles	JB12-5	1SNK912305R0000	20	12.90
4 Circuit separators	Dark grey <input type="checkbox"/>	CS-R3	1SNK900107R0000	20	6.40	
5 Test adapters	Dark grey <input type="checkbox"/>	For test plugs DIA 2 mm 0.079 in	TP2	1SNK900203R0000	20	1.70
		For test plugs DIA 4 mm 0.157 in	TP4	1SNK900205R0000	20	2.40
6 Terminal block markers	White <input type="checkbox"/>	Blank marker	MG-CPM 13 41791	1SNB041791R0612	1680	0.27
		Blank card	MC812	1SNK160000R0000	22	10.00
			MC812PA	1SNK169999R0000	20	14.00
		Universal wire markers holder	Grey <input type="checkbox"/>	UMH	1SNK900611R0000	10

Complete list of accessories is indicated in the terminal block datasheet including end stops.

Some accessories such as jumper bars may modify the terminal block's ratings: Complete information available in the accessories section of the catalog.

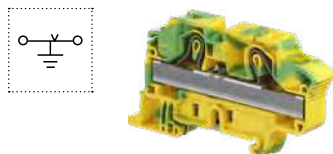

Ground PI-Spring terminal blocks

Description	Color	Type	Part Number	Pkg qty	Weight (1 pce) g
Ground	Green-yellow <input type="checkbox"/>	ZK16-PE	1SNK712150R0000	20	47.00

Technical data valid for copper conductors only.

ZK16-PV PI-Spring terminal blocks

Feed-through - 14 mm 0.551 in spacing



1SNK16Z128V0014

ZK16-PV

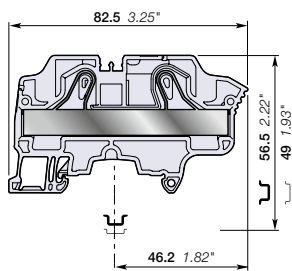

14 mm 0.551 in spacing

Description

Specially designed for high voltage utility scale solar power plants:

- Rated voltage of 1500 V DC IEC and 1000 V DC UL,
- Pre-mounted end section with light grey color specific to this application,
- Improved design with ribs to increase creepage distance,
- Compact solution only 2 mm thicker than normal product,
- No available jumpers for ZK16-PV and ZK16-3P-PV (14 mm spacing).

Ordering details

Description	Color	Type	Part Number	Pkg qty	Weight (1 pce) g
Feed-through 2 connections	Grey <input type="checkbox"/>	ZK16-PV	1SNK712063R0000	15	36.56
	Blue <input type="checkbox"/>	ZK16-PV-BL	1SNK712065R0000	15	36.56

Main technical data

Connecting capacity	IEC	UL - CSA	Mounting instructions		
1 conductor per clamp	Rigid: Solid/Stranded	0.5 ... 25 mm ²	20 ... 4 AWG	Rail	TH 35-7.5, TH 35-15
	Flexible without ferrule	0.5 ... 16 mm ²	20 ... 6 AWG	Wire stripping length	15 mm 0.591 in
	Flexible with non insulated ferrule	0.5 ... 16 mm ²	20 ... 6 AWG	Tool (for flexible conductor without ferrule)	Flat screwdriver Ø 4 mm Ø 0.157 in
	Flexible with insulated ferrule	0.5 ... 16 mm ²	20 ... 6 AWG		
2 conductors per clamp	Flexible with twin ferrule	0.5 ... 6 AWG	20 ... 10 AWG		
Rated current / Rated cross section		76 A / 16 mm ²	75 A / 4 AWG		
Rated short-time withstand current (1s)		1920 A	2544 A		
Short Circuit Current Rating (with specific conditions)			100 kA		
Rated voltage		1000 V AC / 1500 V DC	1000 V		
Impulse withstand voltage		8000 V			
Protection		IP20	NEMA 1		

The connecting capacity data for one Rigid: Solid/Stranded, or one Flexible conductor (when applicable) is a mandatory information required by IEC, UL and CSA standards (Copper conductors). All other data are provided as supplementary information only. For more details, please consult our CB, UL or CSA certificates and technical datasheet available on <http://www.TE.com>

CE	UL CB	RoHS	RoHS	CSA	ERC				
CE	CB	RoHS	USR CNR	CSA	EAC				

Accessories

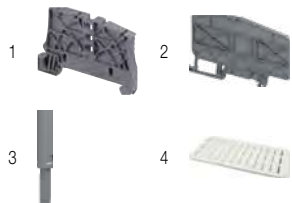

Description	Color	Type	Part Number	Pkg qty	Weight (1 pce) g
1 End stops	Dark grey <input type="checkbox"/>	BAZ1	1SNK900002R0000	50	5.30
2 Circuit separators	Dark grey <input type="checkbox"/>	CS-R3	1SNK900107R0000	20	6.40
3 Test adapters	Dark grey <input type="checkbox"/>	TP2	1SNK900203R0000	20	1.70
		TP4	1SNK900205R0000	20	2.40
4 Terminal block markers	White <input type="checkbox"/>	MC812	1SNK160000R0000	22	10.00
		MC812PA	1SNK169999R0000	20	14.00
		MG-CPM 13 41791	1SNB041791R0612	1680	0.273
	Grey <input type="checkbox"/>	UMH	1SNK900611R0000	10	0.20

Complete list of accessories is indicated in the terminal block datasheet including end stops. Some accessories such as jumper bars may modify the terminal block's ratings. Complete information available in the accessories section of the catalog.



Ground PI-Spring terminal blocks

Description	Color	Type	Part Number	Pkg qty	Weight (1 pce) g
Ground	Green-yellow <input type="checkbox"/>	ZK16-PE	1SNK712150R0000	20	47.00

Technical data valid for copper conductors only.

ZK16-3P PI-Spring terminal blocks

Feed-through with 3 connections - 12 mm 0.472 in spacing



16 mm²
4 AWG



ZK16-3P

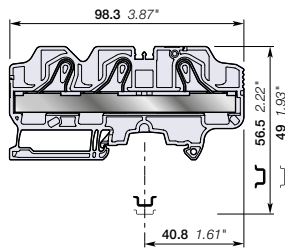

12 mm 0.472 in spacing

Description

- Find all the features of the ZK16 terminal block with the added option of distributing or branching 3 conductors,
- ZK16-3P is perfectly adapted to solar applications: 1250 V DC (1000 V AC) IEC, 1000 V UL.

Ordering details

Description	Color	Type	Part Number	Pkg qty	Weight (1 pce) g
Feed-through 3 connections	Grey <input type="checkbox"/>	ZK16-3P	1SNK712011R0000	20	44.3
	Blue <input type="checkbox"/>	ZK16-3P-BL	1SNK712021R0000	20	44.3

Main technical data

Connecting capacity	IEC	UL - CSA	Rail	Wire stripping length	TH 35-7.5, TH 35-15
1 conductor per clamp	Rigid: Solid/Stranded	0.5 ... 25 mm ²	20 ... 4 AWG	15 mm	0.591 in
	Flexible without ferrule	0.5 ... 16 mm ²			
	Flexible with non insulated ferrule	0.5 ... 16 mm ²	20 ... 6 AWG		
	Flexible with insulated ferrule	0.5 ... 16 mm ²	20 ... 6 AWG		
2 conductors per clamp	Flexible with twin ferrule	0.5 ... 6 mm ²	20 ... 10 AWG	Tool (for flexible conductor without ferrule)	Flat screwdriver Ø 4 mm Ø 0.157 in
Rated current / Rated cross section		76 A / 16 mm ²	75 A / 4 AWG		
Rated short-time withstand current (1s)		1920 A			
Short Circuit Current Rating (with specific conditions)			100 kA		
Rated voltage		1000 V	1000 V		
Impulse withstand voltage		8000 V			
Protection		IP20	NEMA 1		
Increased safety Ex e		693 V 76 A - IM2 II 2 GD Ex eb I/II/III C			

The connecting capacity data for one Rigid: Solid/Stranded, or one Flexible conductor (when applicable) is a mandatory information required by IEC, UL and CSA standards (Copper conductors). All other data are provided as supplementary information only. For more details, please consult our CB, UL or CSA certificates and technical datasheet available on <http://www.TE.com>



Accessories

Description	Color	Type	Part Number	Pkg qty	Weight (1 pce) g	
1 End stops	Dark grey <input type="checkbox"/>	BAZ1	1SNK900002R0000	50	5.30	
2 End sections	Dark grey <input type="checkbox"/>	EK10-3P	1SNK710911R0000	20	4.5	
3 Jumper bars	Orange <input type="checkbox"/>	2 poles	JB12-2	1SNK912302R0000	50	4.90
		3 poles	JB12-3	1SNK912303R0000	50	7.60
		5 poles	JB12-5	1SNK912305R0000	20	12.90
4 Test adapters	Dark grey <input type="checkbox"/>	For test plugs DIA 2 mm 0.079 in	TP2	1SNK900203R0000	20	1.70
		For test plugs DIA 4 mm 0.157 in	TP4	1SNK900205R0000	20	2.40
5 Terminal block markers	White <input type="checkbox"/>	Blank marker	MG-CPM 13 41791	1SNB041791R0612	1680	0.27
		Blank card	MC812	1SNK160000R0000	22	10.00
		Universal wire markers holder	MC812PA	1SNK169999R0000	20	14.00
	Grey <input type="checkbox"/>	UMH	1SNK900611R0000	10	0.20	

Complete list of accessories is indicated in the terminal block datasheet including end stops. Some accessories such as jumper bars may modify the terminal block's ratings: Complete information available in the accessories section of the catalog.

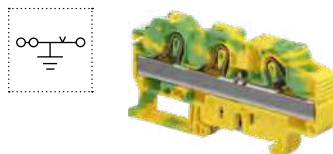

Ground PI-Spring terminal blocks

Description	Color	Type	Part Number	Pkg qty	Weight (1 pce) g
Ground	Green-yellow <input type="checkbox"/>	ZK16-PE-3P	1SNK712151R0000	20	56.65

Technical data valid for copper conductors only.

ZK16-3P-PV PI-Spring terminal blocks

Feed-through with 3 connections - 14 mm 0.551 in spacing



1SNK162130V0014

ZK16-3P-PV

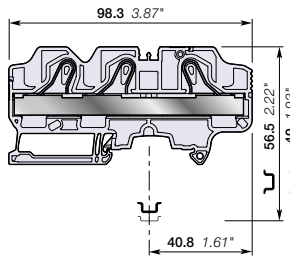

14 mm 0.551 in spacing

Description

Specially designed for high voltage utility scale solar power plants:

- Rated voltage of 1500 V DC IEC and 1000 V DC UL,
- Pre-mounted end section with light grey color specific to this application,
- Improved design with ribs to increase creepage distance,
- Compact solution only 2 mm thicker than normal product,
- 3 connections configuration for easy grouping: 2 inputs / 1 output or 1 input / 2 outputs,
- No available jumpers for ZK16-PV and ZK16-3P-PV (14 mm spacing).

Ordering details

Description	Color	Type	Part Number	Pkg qty	Weight (1 pce) g
Feed-through 3 connections	Grey	ZK16-3P-PV	1SNK712064R0000	15	48.01
	Blue	ZK16-3P-PV-BL	1SNK712067R0000	15	48.01

Main technical data

Connecting capacity		IEC	UL - CSA	Mounting instructions	
1 conductor per clamp	Rigid: Solid/Stranded	0.5 ... 25 mm²	20 ... 4 AWG	Rail	TH 35-7.5, TH 35-15
	Flexible without ferrule	0.5 ... 16 mm²		Wire stripping length	15 mm 0.591 in
	Flexible with non insulated ferrule	0.5 ... 16 mm²	20 ... 6 AWG		
	Flexible with insulated ferrule	0.5 ... 16 mm²	20 ... 6 AWG		
2 conductors per clamp	Flexible with twin ferrule	0.5 ... 6 AWG	20 ... 10 AWG	Tool (for flexible conductor without ferrule)	Flat screwdriver Ø 4 mm Ø 0.157 in
Rated current / Rated cross section		76 A / 16 mm²	75 A / 4 AWG		
Rated short-time withstand current (1s)		1920 A	2544 A		
Short Circuit Current Rating (with specific conditions)			100 kA		
Rated voltage		1000 V AC / 1500 V DC	1000 V		
Impulse withstand voltage		8000 V			
Protection		IP20	NEMA 1		

The connecting capacity data for one Rigid: Solid/Stranded, or one Flexible conductor (when applicable) is a mandatory information required by IEC, UL and CSA standards (Copper conductors). All other data are provided as supplementary information only. For more details, please consult our CB, UL or CSA certificates and technical datasheet available on <http://www.TE.com>

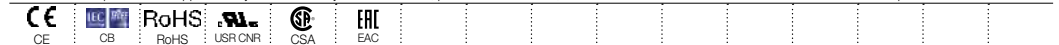

Accessories

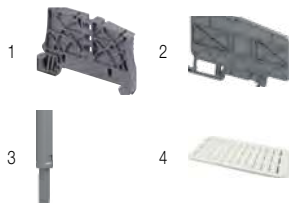

Description	Color	Type	Part Number	Pkg qty	Weight (1 pce) g
1 End stops 5.2 mm 0.205 in	Dark grey	BAZ1	1SNK900002R0000	50	5.30
2 Circuit separators 3 mm 0.118 in	Dark grey	CS-R3	1SNK900107R0000	20	6.40
3 Test adapters For test plugs DIA 2 mm 0.079 in	Dark grey	TP2	1SNK900203R0000	20	1.70
		TP4	1SNK900205R0000	20	2.40
4 Terminal block markers	White	MC812	1SNK160000R0000	22	10.00
		MC812PA	1SNK169999R0000	20	14.00
		MG-CPM 13 41791	1SNB041791R0612	1680	0.273
	Universal wire markers holder	Grey	UMH	1SNK900611R0000	10

Complete list of accessories is indicated in the terminal block datasheet including end stops.

Some accessories such as jumper bars may modify the terminal block's ratings: Complete information available in the accessories section of the catalog.



Ground PI-Spring terminal blocks

Description	Color	Type	Part Number	Pkg qty	Weight (1 pce) g
Ground Profile aligned with ZK16-3P	Green-yellow	ZK16-PE-3P	1SNK712151R0000	20	56.65

Technical data valid for copper conductors only.

ZK2.5-PE PI-Spring terminal blocks

Ground - 5.2 mm 0.205 in spacing



ZK2.5-PE

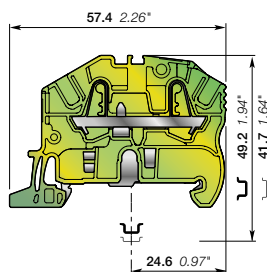

5.2 mm 0.205 in spacing

Description

Improve the safety of your installation in the event of a short-circuit thanks to our screwless rail contact:

- Rail contact non operator dependent,
- Performances above the requirements of the IEC 60947-7-2 terminal block standard,
- Secured snap on or off the rail,
- Profile aligned with ZK2.5.

Ordering details

Description	Color	Type	Part Number	Pkg qty	Weight (1 pce) g
Ground 2 connections	Green-yellow	ZK2.5-PE	1SNK705150R0000	20	10.00

Main technical data

Connecting capacity		IEC	UL - CSA	Mounting instructions
1 conductor per clamp	Rigid: Solid/Stranded	0.2 ... 4 mm²	26 ... 12 AWG	Rail
	Flexible without ferrule	0.22 ... 2.5 mm²		Wire stripping length
	Flexible with non insulated ferrule	0.22 ... 2.5 mm²	26 ... 14 AWG	
	Flexible with insulated ferrule	0.22 ... 2.5 mm²	26 ... 14 AWG	
Rated cross section		2.5 mm²	12 AWG	Tool (for flexible conductor without ferrule)
Rated short-time withstand current (1s)		300 A	396 A	Flat screwdriver Ø 3.5 mm Ø 0.138 in
Protection		IP20	NEMA 1	
Explosive atmosphere classification		IM2 II 2 GD Ex eb I/IC/IIIC - Class I, Zone 1, AEx e II, Ex e II U		

The connecting capacity data for one Rigid: Solid/Stranded, or one Flexible conductor (when applicable) is a mandatory information required by IEC, UL and CSA standards (Copper conductors). All other data are provided as supplementary information only. For more details, please consult our CB, UL or CSA certificates and technical datasheet available on <http://www.TE.com>



Accessories

Description	Color	Type	Part Number	Pkg qty	Weight (1 pce) g
1 End stops	Dark grey	BAZ1	1SNK900002R0000	50	5.30
2 End sections	Dark grey	EK2.5	1SNK705910R0000	20	1.80
3 Circuit separators	Dark grey	CS-R2	1SNK900106R0000	20	3.80
4 Terminal block markers	White	MG-CPM 13 41790	1SNB041790R0512	1960	0.23
		MC512	1SNK140000R0000	22	9.00
		MC512PA	1SNK149999R0000	20	10.00
Universal wire markers holder	Grey	UMH	1SNK900611R0000	10	0.20

Complete list of accessories is indicated in the terminal block datasheet including end stops. Some accessories such as jumper bars may modify the terminal block's ratings: Complete information available in the accessories section of the catalog.

Technical data valid for copper conductors only.

ZK2.5-PE-3P PI-Spring terminal blocks

Ground with 3 connections - 5.2 mm 0.205 in spacing



ZK2.5-PE-3P

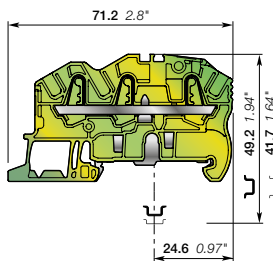

5.2 mm 0.205 in spacing

Description

Improve the safety of your installation in the event of a short-circuit thanks to our screwless rail contact:

- Rail contact non operator dependent,
- Performances above the requirements of the IEC 60947-7-2 terminal block standard,
- Secured snap on or off the rail,
- Profile aligned with ZK2.5-3P.

Ordering details

Description	Color	Type	Part Number	Pkg qty	Weight (1 pce) g
Ground 3 connections	Green-yellow	ZK2.5-PE-3P	1SNK705151R0000	20	11.90

Main technical data

Connecting capacity	IEC	UL - CSA	Mounting instructions		
1 conductor per clamp	Rigid: Solid/Stranded	0.2 ... 4 mm ²	26 ... 12 AWG	Rail	TH 35-7.5, TH 35-15
	Flexible without ferrule	0.22 ... 2.5 mm ²	26 ... 14 AWG	Wire stripping length	11 mm 0.433 in
	Flexible with non insulated ferrule	0.22 ... 2.5 mm ²	26 ... 14 AWG	Tool (for flexible conductor without ferrule)	Flat screwdriver Ø 3.5 mm Ø 0.138 in
	Flexible with insulated ferrule	0.22 ... 2.5 mm ²	26 ... 14 AWG		
Rated cross section		2.5 mm ²	12 AWG		
Rated short-time withstand current (1s)		300 A	396 A		
Protection		IP20	NEMA 1		
Explosive atmosphere classification		IM2 II 2 GD Ex eb I/II/C - Class I, Zone 1, AEx e II, Ex e II U			

The connecting capacity data for one Rigid: Solid/Stranded, or one Flexible conductor (when applicable) is a mandatory information required by IEC, UL and CSA standards (Copper conductors). All other data are provided as supplementary information only. For more details, please consult our CB, UL or CSA certificates and technical datasheet available on <http://www.TE.com>

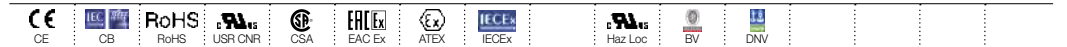

Accessories

Description	Color	Type	Part Number	Pkg qty	Weight (1 pce) g
1 End stops	Dark grey	BAZ1	1SNK900002R0000	50	5.30
2 End sections	Dark grey	EK2.5-3P	1SNK705911R0000	20	2.40
3 Circuit separators	Dark grey	CS-R3	1SNK900107R0000	20	6.40
4 Terminal block markers	White	MG-CPM 13 41790	1SNB041790R0512	1960	0.23
		MC512	1SNK140000R0000	22	9.00
		MC512PA	1SNK149999R0000	20	10.00
Universal wire markers holder	Grey	UMH	1SNK900611R0000	10	0.20

Complete list of accessories is indicated in the terminal block datasheet including end stops. Some accessories such as jumper bars may modify the terminal block's ratings. Complete information available in the accessories section of the catalog.



Technical data valid for copper conductors only.

ZK2.5-PE-4P PI-Spring terminal blocks

Ground with 4 connections - 5.2 mm 0.205 in spacing

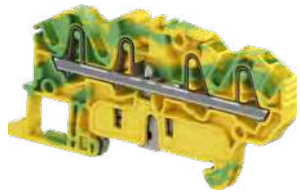

ZK2.5-PE-4P

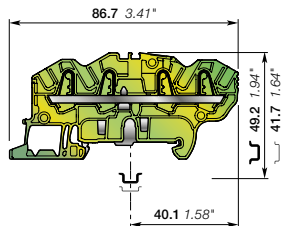

5.2 mm 0.205 in spacing

Description

Improve the safety of your installation in the event of a short-circuit thanks to our screwless rail contact:

- Rail contact non operator dependent,
- Performances above the requirements of the IEC 60947-7-2 terminal block standard,
- Secured snap on or off the rail,
- Profile aligned with ZK2.5-4P.

Ordering details

Description	Color	Type	Part Number	Pkg qty	Weight (1 pce) g
Ground 4 connections	Green-yellow	ZK2.5-PE-4P	1SNK705152R0000	20	13.60

Main technical data

Connecting capacity		IEC	UL - CSA	Mounting instructions	
1 conductor per clamp	Rigid: Solid/Stranded	0.2 ... 4 mm ²	26 ... 12 AWG	Rail	TH 35-7.5, TH 35-15
	Flexible without ferrule	0.22 ... 2.5 mm ²	26 ... 14 AWG	Wire stripping length	11 mm 0.433 in
	Flexible with non insulated ferrule	0.22 ... 2.5 mm ²	26 ... 14 AWG		
	Flexible with insulated ferrule	0.22 ... 2.5 mm ²	26 ... 14 AWG	Tool (for flexible conductor without ferrule)	Flat screwdriver Ø 3.5 mm Ø 0.138 in
Rated cross section		2.5 mm ²	12 AWG		
Rated short-time withstand current (1s)		300 A	396 A		
Protection		IP20	NEMA 1		
Explosive atmosphere classification		IM2 II 2 GD Ex eb I/IC/IIIC - Class I, Zone 1, AEx e II, Ex e II U			

The connecting capacity data for one Rigid: Solid/Stranded, or one Flexible conductor (when applicable) is a mandatory information required by IEC, UL and CSA standards (Copper conductors). All other data are provided as supplementary information only. For more details, please consult our CB, UL or CSA certificates and technical datasheet available on <http://www.TE.com>



Accessories

Description	Color	Type	Part Number	Pkg qty	Weight (1 pce) g
1 End stops	Dark grey	BAZ1	1SNK900002R0000	50	5.30
2 End sections	Dark grey	EK2.5-4P	1SNK705912R0000	20	2.70
3 Circuit separators	Dark grey	CS-R3	1SNK900107R0000	20	6.40
4 Terminal block markers	White	MG-CPM 13 41790	1SNB041790R0512	1960	0.23
		MC512	1SNK140000R0000	22	9.00
		MC512PA	1SNK149999R0000	20	10.00
Universal wire markers holder	Grey	UMH	1SNK900611R0000	10	0.20

Complete list of accessories is indicated in the terminal block datasheet including end stops.

Some accessories such as jumper bars may modify the terminal block's ratings: Complete information available in the accessories section of the catalog.

Technical data valid for copper conductors only.

ZK4-PE PI-Spring terminal blocks

Ground - 6 mm 0.236 in spacing



1SNK16206800014

ZK4-PE

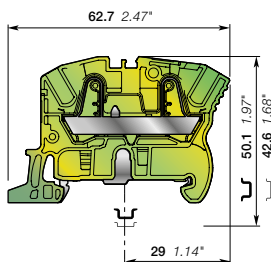

6 mm 0.236 in spacing

Description

Improve the safety of your installation in the event of a short-circuit thanks to our screwless rail contact:

- Rail contact non operator dependent,
- Performances above the requirements of the IEC 60947-7-2 terminal block standard,
- Secured snap on or off the rail,
- Profile aligned with ZK4.

Ordering details

Description	Color	Type	Part Number	Pkg qty	Weight (1 pce) g
Ground 2 connections	Green-yellow	ZK4-PE	1SNK706150R0000	20	12.60

Main technical data

Connecting capacity	IEC	UL - CSA	Mounting instructions		
1 conductor per clamp	Rigid: Solid/Stranded	0.5 ... 6 mm ²	26 ... 10 AWG	Rail	TH 35-7.5, TH 35-15
	Flexible without ferrule	0.5 ... 4 mm ²	26 ... 12 AWG	Wire stripping length	12.5 mm 0.492 in
	Flexible with non insulated ferrule	0.5 ... 4 mm ²	26 ... 12 AWG	Tool (for flexible conductor without ferrule)	Flat screwdriver Ø 3.5 mm Ø 0.138 in
	Flexible with insulated ferrule	0.5 ... 4 mm ²	26 ... 12 AWG		
Rated cross section		4 mm ²	10 AWG		
Rated short-time withstand current (1s)		480 A	636 A		
Protection		IP20	NEMA 1		
Explosive atmosphere classification		IM2 II 2 GD Ex eb I/IC/IIIC - Class I, Zone 1, AEx e II, Ex e II U			

The connecting capacity data for one Rigid: Solid/Stranded, or one Flexible conductor (when applicable) is a mandatory information required by IEC, UL and CSA standards (Copper conductors). All other data are provided as supplementary information only. For more details, please consult our CB, UL or CSA certificates and technical datasheet available on <http://www.TE.com>

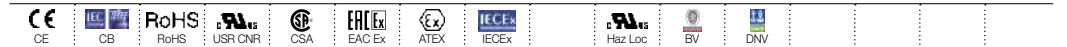

Accessories

Description	Color	Type	Part Number	Pkg qty	Weight (1 pce) g
1 End stops	Dark grey	BAZ1	1SNK900002R0000	50	5.30
2 End sections	Dark grey	EK2.5	1SNK705910R0000	20	1.80
3 Circuit separators	Dark grey	CS-R2	1SNK900106R0000	20	3.80
4 Terminal block markers	White	MG-CPM 13 41791	1SNB041791R0612	1680	0.27
		MC612	1SNK150000R0000	22	10.00
		MC612PA	1SNK159999R0000	20	11.00
Universal wire markers holder	Grey	UMH	1SNK900611R0000	10	0.20

Complete list of accessories is indicated in the terminal block datasheet including end stops. Some accessories such as jumper bars may modify the terminal block's ratings. Complete information available in the accessories section of the catalog.

Technical data valid for copper conductors only.

ZK4-PE-3P PI-Spring terminal blocks

Ground with 3 connections - 6 mm 0.236 in spacing



ZK4-PE-3P

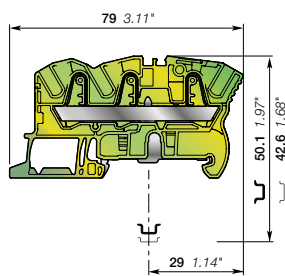

6 mm 0.236 in spacing

Description

Improve the safety of your installation in the event of a short-circuit thanks to our screwless rail contact:

- Rail contact non operator dependent,
- Performances above the requirements of the IEC 60947-7-2 terminal block standard,
- Secured snap on or off the rail,
- Profile aligned with ZK4-3P.

Ordering details

Description	Color	Type	Part Number	Pkg qty	Weight (1 pce) g
Ground 3 connections	Green-yellow	ZK4-PE-3P	1SNK706151R0000	20	15.70

Main technical data

Connecting capacity		IEC	UL - CSA	Mounting instructions	
1 conductor per clamp	Rigid: Solid/Stranded	0.5 ... 6 mm ²	26 ... 10 AWG	Rail	TH 35-7.5, TH 35-15
	Flexible without ferrule	0.5 ... 4 mm ²	26 ... 12 AWG	Wire stripping length	12.5 mm 0.492 in
	Flexible with non insulated ferrule	0.5 ... 4 mm ²	26 ... 12 AWG		
	Flexible with insulated ferrule	0.5 ... 4 mm ²	26 ... 12 AWG	Tool (for flexible conductor without ferrule)	Flat screwdriver Ø 3.5 mm Ø 0.138 in
Rated cross section		4 mm ²	10 AWG		
Rated short-time withstand current (1s)		480 A	636 A		
Protection		IP20	NEMA 1		
Explosive atmosphere classification		IM2 II 2 GD Ex eb I/IC/IIIC - Class I, Zone 1, AEx e II, Ex e II U			

The connecting capacity data for one Rigid: Solid/Stranded, or one Flexible conductor (when applicable) is a mandatory information required by IEC, UL and CSA standards (Copper conductors). All other data are provided as supplementary information only. For more details, please consult our CB, UL or CSA certificates and technical datasheet available on <http://www.TE.com>

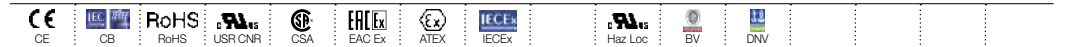

Accessories

Description	Color	Type	Part Number	Pkg qty	Weight (1 pce) g
1 End stops	Dark grey	BAZ1	1SNK900002R0000	50	5.30
2 End sections	Dark grey	EK2.5-3P	1SNK705911R0000	20	2.40
3 Circuit separators	Dark grey	CS-R3	1SNK900107R0000	20	6.40
4 Terminal block markers	White	MG-CPM 13 41791	1SNB041791R0612	1680	0.27
		MC612	1SNK150000R0000	22	10.00
		MC612PA	1SNK159999R0000	20	11.00
Universal wire markers holder	Grey	UMH	1SNK900611R0000	10	0.20

Complete list of accessories is indicated in the terminal block datasheet including end stops.

Some accessories such as jumper bars may modify the terminal block's ratings: Complete information available in the accessories section of the catalog.

Technical data valid for copper conductors only.

ZK4-PE-4P PI-Spring terminal blocks

Ground with 4 connections - 6 mm 0.236 in spacing



ZK4-PE-4P

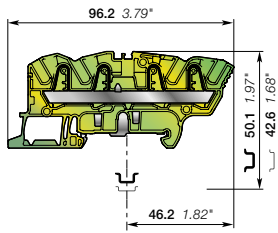

6 mm 0.236 in spacing

Description

Improve the safety of your installation in the event of a short-circuit thanks to our screwless rail contact:

- Rail contact non operator dependent,
- Performances above the requirements of the IEC 60947-7-2 terminal block standard,
- Secured snap on or off the rail,
- Profile aligned with ZK4-4P.

Ordering details

Description	Color	Type	Part Number	Pkg qty	Weight (1 pce) g
Ground 4 connections	Green-yellow	ZK4-PE-4P	1SNK706152R0000	20	18.40

Main technical data

Connecting capacity	IEC	UL - CSA	Rail	Wire stripping length	Tool (for flexible conductor without ferrule)
1 conductor per clamp	Rigid: Solid/Stranded	0.5 ... 6 mm ²	26 ... 10 AWG		
	Flexible without ferrule	0.5 ... 4 mm ²	26 ... 12 AWG		
	Flexible with non insulated ferrule	0.5 ... 4 mm ²	26 ... 12 AWG		
	Flexible with insulated ferrule	0.5 ... 4 mm ²	26 ... 12 AWG		
Rated cross section	4 mm ²	10 AWG			
Rated short-time withstand current (1s)	480 A	636 A			
Protection	IP20	NEMA 1			
Explosive atmosphere classification	IM2 II 2 GD Ex eb I/IC/IIIC - Class I, Zone 1, AEx e II, Ex e II U				

The connecting capacity data for one Rigid: Solid/Stranded, or one Flexible conductor (when applicable) is a mandatory information required by IEC, UL and CSA standards (Copper conductors). All other data are provided as supplementary information only. For more details, please consult our CB, UL or CSA certificates and technical datasheet available on <http://www.TE.com>

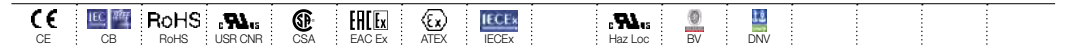

Accessories

Description	Color	Type	Part Number	Pkg qty	Weight (1 pce) g
1 End stops	Dark grey	BAZ1	1SNK900002R0000	50	5.30
2 End sections	Dark grey	EK2.5-4P	1SNK705912R0000	20	2.70
3 Circuit separators	Dark grey	CS-R3	1SNK900107R0000	20	6.40
4 Terminal block markers	White	MG-CPM 13 41791	1SNB041791R0612	1680	0.27
		MC612	1SNK150000R0000	22	10.00
		MC612PA	1SNK159999R0000	20	11.00
Universal wire markers holder	Grey	UMH	1SNK900611R0000	10	0.20

Complete list of accessories is indicated in the terminal block datasheet including end stops. Some accessories such as jumper bars may modify the terminal block's ratings. Complete information available in the accessories section of the catalog.

Technical data valid for copper conductors only.

ZK6-PE PI-Spring terminal blocks

Ground - 8 mm 0.315 in spacing



6 mm²
8 AWG



1SNK1620450201

ZK6-PE

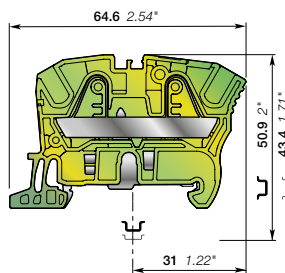

8 mm 0.315 in spacing

Description

Improve the safety of your installation in the event of a short-circuit thanks to our screwless rail contact:

- Rail contact non operator dependent,
- Performances above the requirements of the IEC 60947-7-2 terminal block standard,
- Secured snap on or off the rail,
- Profile aligned with ZK6.

Ordering details

Description	Color	Type	Part Number	Pkg qty	Weight (1 pce) g
Ground 2 connections	Green-yellow	ZK6-PE	1SNK708150R0000	20	20.30

Main technical data

Connecting capacity		IEC	UL - CSA	Mounting instructions	
1 conductor per clamp	Rigid: Solid/Stranded	0.5 ... 10 mm ²	24 ... 8 AWG	Rail	TH 35-7.5, TH 35-15
	Flexible without ferrule	0.5 ... 6 mm ²		Wire stripping length	12.5 mm 0.492 in
	Flexible with non insulated ferrule	0.5 ... 6 mm ²	24 ... 10 AWG		
	Flexible with insulated ferrule	0.5 ... 6 mm ²	24 ... 10 AWG		
Rated cross section		6 mm ²	8 AWG	Tool (for flexible conductor without ferrule)	Flat screwdriver Ø 3.5 mm Ø 0.138 in
Rated short-time withstand current (1s)		720 A	1008 A		
Protection		IP20	NEMA 1		
Explosive atmosphere classification		IM2 II 2 GD Ex eb I/IC/IIIC - Class I, Zone 1, AEx e II, Ex e II U			

The connecting capacity data for one Rigid: Solid/Stranded, or one Flexible conductor (when applicable) is a mandatory information required by IEC, UL and CSA standards (Copper conductors). All other data are provided as supplementary information only. For more details, please consult our CB, UL or CSA certificates and technical datasheet available on <http://www.TE.com>



Accessories



Description	Color	Type	Part Number	Pkg qty	Weight (1 pce) g
1 End stops	Dark grey	BAZ1	1SNK900002R0000	50	5.30
2 End sections	Dark grey	EK2.5	1SNK705910R0000	20	1.80
3 Circuit separators	Dark grey	CS-R2	1SNK900106R0000	20	3.80
4 Terminal block markers	White	MG-CPM 13 41791	1SNB041791R0612	1680	0.27
		MC812	1SNK160000R0000	22	10.00
		MC812PA	1SNK169999R0000	20	14.00
Universal wire markers holder	Grey	UMH	1SNK900611R0000	10	0.20

Complete list of accessories is indicated in the terminal block datasheet including end stops.

Some accessories such as jumper bars may modify the terminal block's ratings: Complete information available in the accessories section of the catalog.

Technical data valid for copper conductors only.

ZK6-PE-3P PI-Spring terminal blocks

Ground with 3 connections - 8 mm 0.315 in spacing

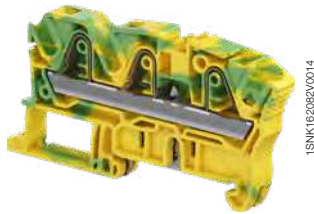

1SNK162026V0014

ZK6-PE-3P

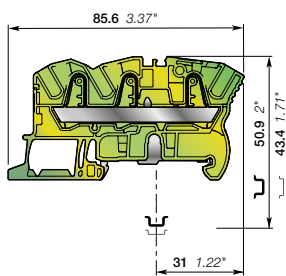

8 mm 0.315 in spacing

Description

- Improve the safety of your installation in the event of a short-circuit thanks to our screwless rail contact:
- Rail contact non operator dependent,
 - Performances above the requirements of the IEC 60947-7-2 terminal block standard,
 - Secured snap on or off the rail,
 - Profile aligned with ZK6-3P.

Ordering details

Description	Color	Type	Part Number	Pkg qty	Weight (1 pce) g
Ground 3 connections	Green-yellow	ZK6-PE-3P	1SNK708151R0000	20	21.50

Main technical data

Connecting capacity	IEC	UL - CSA	Mounting instructions		
1 conductor per clamp	Rigid: Solid/Stranded	0.5 ... 10 mm ²	24 ... 8 AWG	Rail	TH 35-7.5, TH 35-15
	Flexible without ferrule	0.5 ... 6 mm ²	24 ... 8 AWG	Wire stripping length	12.5 mm 0.492 in
	Flexible with non insulated ferrule	0.5 ... 6 mm ²	24 ... 10 AWG	Tool (for flexible conductor without ferrule)	Flat screwdriver Ø 3.5 mm Ø 0.138 in
	Flexible with insulated ferrule	0.5 ... 6 mm ²	24 ... 10 AWG		
Rated cross section		6 mm ²	8 AWG		
Rated short-time withstand current (1s)		720 A	1008 A		
Protection		IP20	NEMA 1		
Explosive atmosphere classification		IM2 II 2 GD Ex eb I/IC/IIC - Class I, Zone 1, AEx e II, Ex e II U			

The connecting capacity data for one Rigid: Solid/Stranded, or one Flexible conductor (when applicable) is a mandatory information required by IEC, UL and CSA standards (Copper conductors). All other data are provided as supplementary information only. For more details, please consult our CB, UL or CSA certificates and technical datasheet available on <http://www.TE.com>

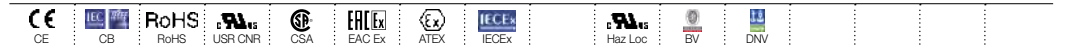

Accessories

Description	Color	Type	Part Number	Pkg qty	Weight (1 pce) g
1 End stops	Dark grey	BAZ1	1SNK900002R0000	50	5.30
2 End sections	Dark grey	EK6-3P	1SNK708911R0000	20	2.80
3 Circuit separators	Dark grey	CS-R3	1SNK900107R0000	20	6.40
4 Terminal block markers	White	MG-CPM 13 41791	1SNB041791R0612	1680	0.27
		MC812	1SNK160000R0000	22	10.00
		MC812PA	1SNK169999R0000	20	14.00
Universal wire markers holder	Grey	UMH	1SNK900611R0000	10	0.20

Complete list of accessories is indicated in the terminal block datasheet including end stops. Some accessories such as jumper bars may modify the terminal block's ratings. Complete information available in the accessories section of the catalog.



Technical data valid for copper conductors only.

ZK10-PE PI-Spring terminal blocks

Ground - 10 mm 0.394 in spacing



ZK10-PE

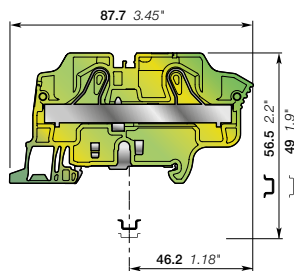

10 mm 0.394 in spacing

Description

Improve the safety of your installation in the event of a short-circuit thanks to our screwless rail contact:

- Rail contact non operator dependent,
- Performances above the requirements of the IEC 60947-7-2 terminal block standard,
- Secured snap on or off the rail,
- Profile aligned with ZK10.

Ordering details

Description	Color	Type	Part Number	Pkg qty	Weight (1 pce) g
Ground 2 connections	Green-yellow	ZK10-PE	1SNK710150R0000	20	36.20

Main technical data

Connecting capacity		IEC	UL - CSA	Mounting instructions	
1 conductor per clamp	Rigid: Solid/Stranded	0.5 ... 16 mm ²	20 ... 6 AWG	Rail	TH 35-7.5, TH 35-15
	Flexible without ferrule	0.5 ... 10 mm ²	20 ... 8 AWG	Wire stripping length	15 mm 0.591 in
	Flexible with non insulated ferrule	0.5 ... 10 mm ²	20 ... 8 AWG		
	Flexible with insulated ferrule	0.5 ... 10 mm ²	20 ... 8 AWG	Tool (for flexible conductor without ferrule)	Flat screwdriver Ø 4 mm Ø 0.157 in
Rated cross section		10 mm ²	6 AWG		
Rated short-time withstand current (1s)		1200 A	1596 A		
Protection		IP20	NEMA 1		
Explosive atmosphere classification		IM2 II 2 GD Ex eb I/IC/IIIC - Class I, Zone 1, AEx e II, Ex e II U			

The connecting capacity data for one Rigid: Solid/Stranded, or one Flexible conductor (when applicable) is a mandatory information required by IEC, UL and CSA standards (Copper conductors). All other data are provided as supplementary information only. For more details, please consult our CB, UL or CSA certificates and technical datasheet available on <http://www.TE.com>

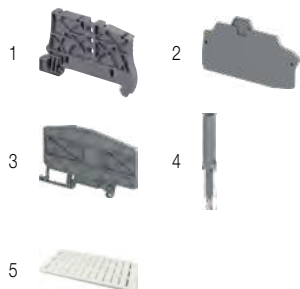

Accessories

Description	Color	Type	Part Number	Pkg qty	Weight (1 pce) g
1 End stops	Dark grey	BAZ1	1SNK900002R0000	50	5.30
2 End sections	Dark grey	EK10	1SNK710910R0000	20	3.30
3 Circuit separators	Dark grey	CS-R3	1SNK900107R0000	20	6.40
4 Test adapters	Dark grey	TP2	1SNK900203R0000	20	1.70
		TP4	1SNK900205R0000	20	2.40
5 Terminal block markers	White	MG-CPM 13 41791	1SNB041791R0612	1680	0.27
		MC812	1SNK160000R0000	22	10.00
		MC812PA	1SNK169999R0000	20	14.00
		Universal wire markers holder	Grey	UMH	1SNK900611R0000

Complete list of accessories is indicated in the terminal block datasheet including end stops. Some accessories such as jumper bars may modify the terminal block's ratings: Complete information available in the accessories section of the catalog.

Technical data valid for copper conductors only.

ZK10-PE-3P PI-Spring terminal blocks

Ground with 3 connections - 10 mm 0.394 in spacing



ZK10-PE-3P

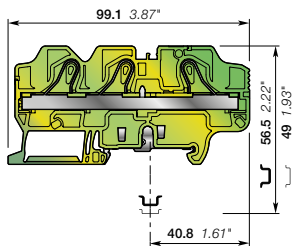

10 mm 0.394 in spacing

Description

Improve the safety of your installation in the event of a short-circuit thanks to our screwless rail contact:

- Rail contact non operator dependent,
- Performances above the requirements of the IEC 60947-7-2 standard,
- Secured snap on or off the rail,
- Profile aligned with ZK10-3P.

Ordering details

Description	Color	Type	Part Number	Pkg qty	Weight (1 pce) g
Ground 3 connections	Green-yellow	ZK10-PE-3P	1SNK710151R0000	20	43.3

Main technical data

Connecting capacity	IEC	UL - CSA	Rail	Wire stripping length	TH 35-7.5, TH 35-15
1 conductor per clamp	Rigid: Solid/Stranded	0.5 ... 16 mm ²	20 ... 6 AWG		15 mm
	Flexible without ferrule	0.5 ... 10 mm ²	20 ... 8 AWG		0.591 in
	Flexible with non insulated ferrule	0.5 ... 10 mm ²	20 ... 8 AWG		
	Flexible with insulated ferrule	0.5 ... 10 mm ²	20 ... 8 AWG		
Rated cross section	10 mm ²	6 AWG	Tool (for flexible conductor without ferrule)		Flat screwdriver Ø 4 mm Ø 0.157 in
Rated short-time withstand current (1s)	1200 A	1596 A			
Protection	IP20	NEMA 1			
Explosive atmosphere classification	IM2 II 2 GD Ex eb I/II/III C				

The connecting capacity data for one Rigid: Solid/Stranded, or one Flexible conductor (when applicable) is a mandatory information required by IEC, UL and CSA standards (Copper conductors). All other data are provided as supplementary information only. For more details, please consult our CB, UL or CSA certificates and technical datasheet available on <http://www.TE.com>



Accessories

Description	Color	Type	Part Number	Pkg qty	Weight (1 pce) g	
1 End stops	Dark grey	BAZ1	1SNK900002R0000	50	5.30	
2 End sections	Dark grey	EK10-3P	1SNK710911R0000	20	4.5	
3 Test adapters	Dark grey	For test plugs DIA 2 mm 0.079 in	TP2	1SNK900203R0000	20	1.70
		For test plugs DIA 4 mm 0.157 in	TP4	1SNK900205R0000	20	2.40
4 Terminal block markers	White	Blank marker	MG-CPM 13 41791	1SNB041791R0612	1680	0.27
		Blank card	MC812	1SNK160000R0000	22	10.00
		Universal wire markers holder	Grey	UMH	1SNK169999R0000	20
				10	0.20	

Complete list of accessories is indicated in the terminal block datasheet including end stops.

Some accessories such as jumper bars may modify the terminal block's ratings: Complete information available in the accessories section of the catalog.

Technical data valid for copper conductors only.

ZK16-PE PI-Spring terminal blocks

Ground - 12 mm 0.472 in spacing



ZK16-PE

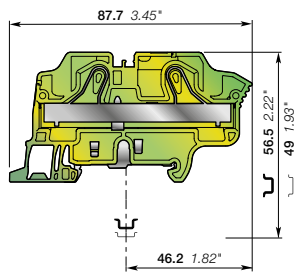

12 mm 0.472 in spacing

Description

Improve the safety of your installation in the event of a short-circuit thanks to our screwless rail contact:

- Rail contact non operator dependent,
- Performances above the requirements of the IEC 60947-7-2 terminal block standard,
- Secured snap on or off the rail,
- Profile aligned with ZK16.

Ordering details

Description	Color	Type	Part Number	Pkg qty	Weight (1 pce) g
Ground 2 connections	Green-yellow	ZK16-PE	1SNK712150R0000	20	47.00

Main technical data

Connecting capacity	IEC	UL - CSA	Mounting instructions
1 conductor per clamp Rigid: Solid/Stranded Flexible without ferrule Flexible with non insulated ferrule Flexible with insulated ferrule	0.5 ... 25 mm ²	20 ... 4 AWG	Rail TH 35-7.5, TH 35-15 Wire stripping length 15 mm 0.591 in
	0.5 ... 16 mm ²	20 ... 6 AWG	Tool (for flexible conductor without ferrule) Flat screwdriver Ø 4 mm Ø 0.157 in
	0.5 ... 16 mm ²	20 ... 6 AWG	
	0.5 ... 16 mm ²	20 ... 6 AWG	
Rated cross section	16 mm ²	4 AWG	
Rated short-time withstand current (1s)	1920 A	2544 A	
Protection	IP20	NEMA 1	
Explosive atmosphere classification	IM2 II 2 GD Ex eb I/IC/IIIC - Class I, Zone 1, AEx e II, Ex e II U		

The connecting capacity data for one Rigid: Solid/Stranded, or one Flexible conductor (when applicable) is a mandatory information required by IEC, UL and CSA standards (Copper conductors). All other data are provided as supplementary information only. For more details, please consult our CB, UL or CSA certificates and technical datasheet available on <http://www.TE.com>

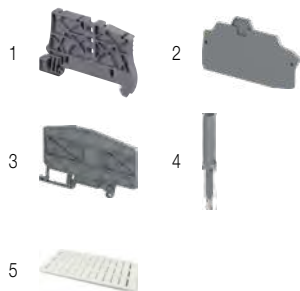
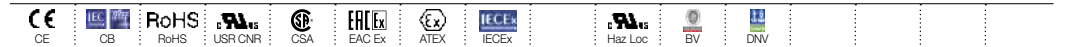

Accessories

Description	Color	Type	Part Number	Pkg qty	Weight (1 pce) g
1 End stops	Dark grey	BAZ1	1SNK900002R0000	50	5.30
2 End sections	Dark grey	EK10	1SNK710910R0000	20	3.30
3 Circuit separators	Dark grey	CS-R3	1SNK900107R0000	20	6.40
4 Test adapters	Dark grey	TP2	1SNK900203R0000	20	1.70
		TP4	1SNK900205R0000	20	2.40
5 Terminal block markers	White	MG-CPM 13 41791	1SNB041791R0612	1680	0.27
		MC812	1SNK160000R0000	22	10.00
		MC812PA	1SNK169999R0000	20	14.00
		Universal wire markers holder	Grey	UMH	1SNK900611R0000

Complete list of accessories is indicated in the terminal block datasheet including end stops. Some accessories such as jumper bars may modify the terminal block's ratings: Complete information available in the accessories section of the catalog.

Technical data valid for copper conductors only.

ZK16-PE-3P PI-Spring terminal blocks

Ground with 3 connections - 12 mm 0.472 in spacing



1SNK162100V0014

ZK16-PE-3P

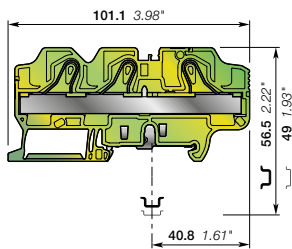

12 mm 0.472 in spacing

Description

Improve the safety of your installation in the event of a short-circuit thanks to our screwless rail contact:

- Rail contact non operator dependent,
- Performances above the requirements of the IEC 60947-7-2 standard,
- Secured snap on or off the rail,
- Profile aligned with ZK16-3P.

Ordering details

Description	Color	Type	Part Number	Pkg qty	Weight (1 pce) g
Ground 3 connections	Green-yellow	ZK16-PE-3P	1SNK712151R0000	20	56.65

Main technical data

Connecting capacity	IEC	UL - CSA	Rail	Wire stripping length	Tool (for flexible conductor without ferrule)
1 conductor per clamp	Rigid: Solid/Stranded	0.5 ... 25 mm²	20 ... 4 AWG	15 mm 0.591 in	Flat screwdriver Ø 4 mm Ø 0.157 in
	Flexible without ferrule	0.5 ... 16 mm²	20 ... 6 AWG		
	Flexible with non insulated ferrule	0.5 ... 16 mm²	20 ... 6 AWG		
	Flexible with insulated ferrule	0.5 ... 16 mm²	20 ... 6 AWG		
Rated cross section	16 mm²	4 AWG			
Rated short-time withstand current (1s)	1920 A	2544 A			
Protection	IP20	NEMA 1			
Explosive atmosphere classification	IM2 II 2 GD Ex eb I/II/III C				

The connecting capacity data for one Rigid: Solid/Stranded, or one Flexible conductor (when applicable) is a mandatory information required by IEC, UL and CSA standards (Copper conductors). All other data are provided as supplementary information only. For more details, please consult our CB, UL or CSA certificates and technical datasheet available on <http://www.TE.com>



Accessories

Description	Color	Type	Part Number	Pkg qty	Weight (1 pce) g
1 End stops	Dark grey	BAZ1	1SNK900002R0000	50	5.30
2 End sections	Dark grey	EK10-3P	1SNK710911R0000	20	4.5
3 Test adapters	Dark grey	TP2	1SNK900203R0000	20	1.70
		TP4	1SNK900205R0000	20	2.40
4 Terminal block markers	White	MG-CPM 13 41791	1SNB041791R0612	1680	0.27
		MC812	1SNK160000R0000	22	10.00
		MC812PA	1SNK169999R0000	20	14.00
	Universal wire markers holder	Grey	UMH	1SNK900611R0000	10

Complete list of accessories is indicated in the terminal block datasheet including end stops.

Some accessories such as jumper bars may modify the terminal block's ratings: Complete information available in the accessories section of the catalog.

Technical data valid for copper conductors only.

ZK2.5-S PI-Spring terminal blocks

Disconnect with blade - with test sockets - 5.2 mm 0.205 in spacing



ZK2.5-S

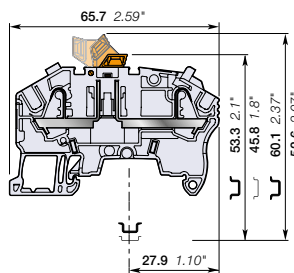

5.2 mm 0.205 in spacing

Description

Combine high performance with compact dimensions: 630 V IEC 300 V UL.

Secure the current measurement:

- for currents below 50 mA, thanks to 2 built in test points DIA 2 mm 0.079 in,
- for currents up to 16 A, by using the TP4 test adapter inserted into the jumper channels.

Ordering details

Description	Color	Type	Part Number	Pkg qty	Weight (1 pce) g
Disconnect with 2 test sockets DIA 2 mm 0.079 in	Grey	ZK2.5-S	1SNK705310R0000	50	8.10
	Blue	ZK2.5-S-BL	1SNK705320R0000	50	8.10
	Orange	ZK2.5-S-OR	1SNK705330R0000	50	8.10

Main technical data

Connecting capacity		IEC	UL - CSA	Mounting instructions	
1 conductor per clamp	Rigid: Solid/Stranded	0.2 ... 4 mm²	26 ... 12 AWG	Rail	TH 35-7.5, TH 35-15
	Flexible without ferrule	0.22 ... 2.5 mm²		Wire stripping length	11 mm 0.433 in
	Flexible with non insulated ferrule	0.22 ... 2.5 mm²	26 ... 14 AWG		
	Flexible with insulated ferrule	0.22 ... 2.5 mm²	26 ... 14 AWG		
2 conductors per clamp	Flexible with twin ferrule	0.22 ... 0.5 mm²	26 ... 20 AWG	Tool (for flexible conductor without ferrule)	Flat screwdriver Ø 3.5 mm Ø 0.138 in
Rated current / Rated cross section		20 A / 2.5 mm²	20 A / 12 AWG		
Rated short-time withstand current (1s)		300 A	396 A		
Rated voltage		630 V	300 V		
Impulse withstand voltage		6000 V			
Protection		IP20	NEMA 1		

Recommendation for best usage: in horizontal assemblies, disconnect terminal blocks should be mounted with fixed foot on top (power side) so that the disconnect knife does not partially close through gravity. Furthermore, as specified per IEC 60947-7-1, disconnect terminal blocks are intended to be used for temporary disconnection at zero potential and at no load.

The connecting capacity data for one Rigid: Solid/Stranded, or one Flexible conductor (when applicable) is a mandatory information required by IEC, UL and CSA standards (Copper conductors). All other data are provided as supplementary information only. For more details, please consult our CB, UL or CSA certificates and technical datasheet available on <http://www.TE.com>

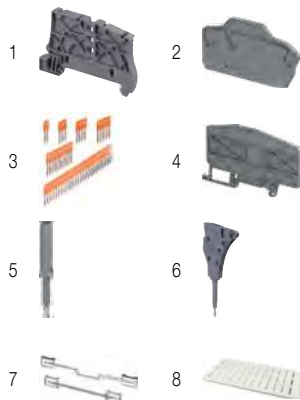
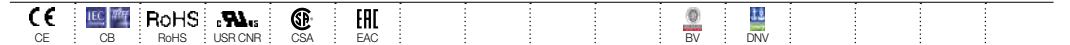

Accessories

Description	Color	Type	Part Number	Pkg qty	Weight (1 pce) g	
1 End stops	Dark grey	BAZ1	1SNK900002R0000	50	5.30	
2 End sections	Dark grey	EK2.5-3P	1SNK705911R0000	20	2.40	
3 Jumper bars	Orange	2 poles 32 A (IEC)	JB5-2	1SNK905302R0000	50	1.30
		3 poles 32 A (IEC)	JB5-3	1SNK905303R0000	50	2.00
		4 poles 32 A (IEC)	JB5-4	1SNK905304R0000	50	2.70
		5 poles 32 A (IEC)	JB5-5	1SNK905305R0000	50	3.50
		10 poles 32 A (IEC)	JB5-10	1SNK905310R0000	30	7.10
		50 poles 32 A (IEC)	JB5-50	1SNK905350R0000	10	36.00
4 Circuit separators	Dark grey	CS-R3	1SNK900107R0000	20	6.40	
5 Test adapters	Dark grey	For test plugs DIA 2 mm 0.079 in	TP2	1SNK900203R0000	20	1.70
		For test plugs DIA 4 mm 0.157 in	TP4	1SNK900205R0000	20	2.40
6 Test connectors	Dark grey	5.2 mm 0.205 in spacing	TC5	1SNK900200R0000	10	5.20
		End module, 5.2 mm 0.205 in	TC5-R1	1SNK900201R0000	10	5.20
			SHBP	1SNK900601R0000	20	4.10
8 Terminal block markers	White	Blank marker	MG-CPM 13 41790	1960	0.23	
		Blank card	MC512	1SNK140000R0000	22	9.00
			MC512PA	1SNK149999R0000	20	10.00
		Universal wire markers holder	Grey	UMH	1SNK900611R0000	10

Complete list of accessories is indicated in the terminal block datasheet including end stops.

Some accessories such as jumper bars may modify the terminal block's ratings: Complete information available in the accessories section of the catalog.

Technical data valid for copper conductors only.

ZK2.5-S-4P PI-Spring terminal blocks

Disconnect with blade - with test socket - 5.2 mm 0.205 in spacing



ZK2.5-S-4P

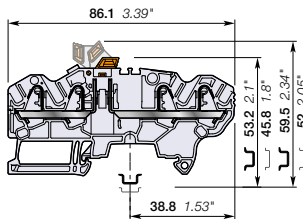

5.2 mm 0.205 in spacing

Description

- Combine high performances with compact dimensions: 630 V IEC 300 V UL,
- Simplify the measurement with 1 built in test point DIA 2 mm 0.079 in (for current below 50mA) and TP... test adapter inserted into one jumper channel,
- Clear marking visibility with SNK top marking location 20% enlarged.

Ordering details

Description	Color	Type	Part Number	Pkg qty	Weight (1 pce) g
Disconnect with 1 test socket DIA 2 mm 0.079 in	Grey	ZK2.5-S-4P	1SNK705312R0000	50	11.14
	Blue	ZK2.5-S-4P-BL	1SNK705321R0000	50	11.14
	Orange	ZK2.5-S-4P-OR	1SNK705331R0000	50	11.14

Main technical data

Connecting capacity		IEC	UL - CSA	Mounting instructions	
1 conductor per clamp	Rigid: Solid/Stranded	0.2 ... 4 mm ²	26 ... 12 AWG	Rail	TH 35-7.5, TH 35-15
	Flexible without ferrule	0.22 ... 2.5 mm ²		Wire stripping length	11 mm 0.433 in
	Flexible with non insulated ferrule	0.22 ... 2.5 mm ²	26 ... 14 AWG	Tool (for flexible conductor without ferrule)	Flat screwdriver Ø 3.5 mm Ø 0.138 in
	Flexible with insulated ferrule	0.22 ... 2.5 mm ²	26 ... 14 AWG		
2 conductors per clamp	Flexible with twin ferrule	0.22 ... 0.5 mm ²	26 ... 20 AWG		
Rated current / Rated cross section		20 A / 2.5 mm ²	20 A / 12 AWG		
Rated short-time withstand current (1s)		300 A			
Short Circuit Current Rating (with specific conditions)					
Rated voltage		630 V	300 V		
Impulse withstand voltage		6000 V			
Protection		IP20	NEMA 1		

Recommendation for best usage: in horizontal assemblies, disconnect terminal blocks should be mounted with fixed foot on top (power side) so that the disconnect knife does not partially close through gravity. Furthermore, as specified per IEC 60947-7-1, disconnect terminal blocks are intended to be used for temporary disconnection at zero potential and at no load.

The connecting capacity data for one Rigid: Solid/Stranded, or one Flexible conductor (when applicable) is a mandatory information required by IEC, UL and CSA standards (Copper conductors). All other data are provided as supplementary information only. For more details, please consult our CB, UL or CSA certificates and technical datasheet available on <http://www.TE.com>

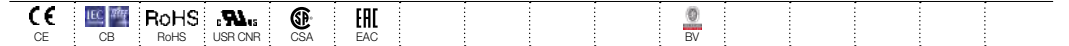

Accessories



Description	Color	Type	Part Number	Pkg qty	Weight (1 pce) g	
1 End stops	Dark grey	BAZ1	1SNK900002R0000	50	5.30	
2 End sections	Dark grey	EK2.5-S-4P	1SNK705913R0000	20	2.94	
3 Jumper bars	Orange	2 poles	JB5-2	1SNK905302R0000	50	1.30
		3 poles	JB5-3	1SNK905303R0000	50	2.00
		4 poles	JB5-4	1SNK905304R0000	50	2.70
		5 poles	JB5-5	1SNK905305R0000	50	3.50
		10 poles	JB5-10	1SNK905310R0000	30	7.10
		50 poles	JB5-50	1SNK905350R0000	10	36.00
4 Circuit separators	Dark grey	CS-R3	1SNK900107R0000	20	6.40	
5 Test adapters	Dark grey	For test plugs DIA 2 mm 0.079 in	TP2	1SNK900203R0000	20	1.70
		For test plugs DIA 4 mm 0.157 in	TP4	1SNK900205R0000	20	2.40
6 Test connectors	Dark grey	5.2 mm 0.205 in spacing	TC5	1SNK900200R0000	10	5.20
		End module, 5.2 mm 0.205 in	TC5-R1	1SNK900201R0000	10	5.20
		Blank marker	White	MG-CPM 13 41790	1960	0.23
7 Terminal block markers	White	Blank card	MC512	1SNK140000R0000	22	9.00
		Universal wire markers holder	Grey	UMH	1SNK900611R0000	10

Complete list of accessories is indicated in the terminal block datasheet including end stops.

Some accessories such as jumper bars may modify the terminal block's ratings: Complete information available in the accessories section of the catalog.

Technical data valid for copper conductors only.

ZK2.5-S-R1 PI-Spring terminal blocks

Disconnect with blade - 6 mm 0.236 in spacing



ZK2.5-S-R1

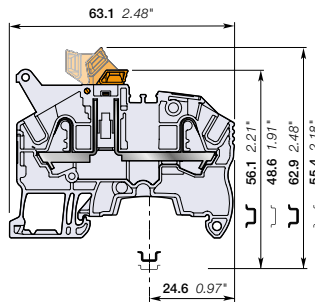

6 mm 0.236 in spacing

Description

Simplify the distribution of circuits in marshalling cabinets thanks to our disconnect terminal blocks with the same profile as ZK2.5-SF fuse.

Ordering details

Description	Color	Type	Part Number	Pkg qty	Weight (1 pce) g
Disconnect Profile aligned with ZK2.5-SF	Grey <input type="checkbox"/>	ZK2.5-S-R1	1SNK706310R0000	50	8.90

Main technical data

Connecting capacity	IEC	UL - CSA	Mounting instructions
1 conductor per clamp	Rigid: Solid/Stranded Flexible without ferrule Flexible with non insulated ferrule Flexible with insulated ferrule	0.2 ... 4 mm ² 0.22 ... 2.5 mm ² 0.22 ... 2.5 mm ² 0.22 ... 2.5 mm ²	26 ... 12 AWG 26 ... 14 AWG 26 ... 14 AWG 26 ... 14 AWG
2 conductors per clamp	Flexible with twin ferrule	0.22 ... 0.5 mm ²	26 ... 20 AWG
Rated current / Rated cross section	20 A / 2.5 mm ²	20 A / 12 AWG	
Rated short-time withstand current (1s)	300 A	396 A	
Rated voltage	630 V	300 V	
Impulse withstand voltage	6000 V		
Protection	IP20	NEMA 1	

Recommendation for best usage: in horizontal assemblies, disconnect terminal blocks should be mounted with fixed foot on top (power side) so that the disconnect knife does not partially close through gravity. Furthermore, as specified per IEC 60947-7-1, disconnect terminal blocks are intended to be used for temporary disconnection at zero potential and at no load.

The connecting capacity data for one Rigid: Solid/Stranded, or one Flexible conductor (when applicable) is a mandatory information required by IEC, UL and CSA standards (Copper conductors). All other data are provided as supplementary information only. For more details, please consult our CB, UL or CSA certificates and technical datasheet available on <http://www.TE.com>



Accessories

Description	Color	Type	Part Number	Pkg qty	Weight (1 pce) g
1 End stops	Dark grey <input type="checkbox"/>	BAZ1	1SNK900002R0000	50	5.30
2 End sections	Dark grey <input type="checkbox"/>	EK2.5-3P	1SNK705911R0000	20	2.40
3 Jumper bars	Orange <input type="checkbox"/>	JB6-2 JB6-3 JB6-4 JB6-5 JB6-10 JB6-50	1SNK906302R0000 1SNK906303R0000 1SNK906304R0000 1SNK906305R0000 1SNK906310R0000 1SNK906350R0000	50 50 50 50 20 10	1.30 2.10 2.90 3.60 7.40 38.10
4 Circuit separators	Dark grey <input type="checkbox"/>	CS-R3	1SNK900107R0000	20	6.40
5 Test adapters	Dark grey <input type="checkbox"/>	TP2 TP4	1SNK900203R0000 1SNK900205R0000	20 20	1.70 2.40
6 Test connectors	Dark grey <input type="checkbox"/>	TC5-R1	1SNK900201R0000	10	5.20
7 Spacers	Dark grey <input type="checkbox"/>	ES-TC6	1SNK900105R0000	10	0.80
8 Terminal block markers	White <input type="checkbox"/>	MG-CPM 13 41791 MC612 MC612PA Universal wire markers holder	1SNB041791R0612 1SNK150000R0000 1SNK159999R0000 1SNK900611R0000	1680 22 20 10	0.27 10.00 11.00 0.20

Complete list of accessories is indicated in the terminal block datasheet including end stops. Some accessories such as jumper bars may modify the terminal block's ratings. Complete information available in the accessories section of the catalog.

PI-Spring terminal blocks

Description	Color	Type	Part Number	Pkg qty	Weight (1 pce) g
Feed-through	Grey <input type="checkbox"/>	ZK4-3P	1SNK706011R0000	50	11.00
Fuse	Grey, dark grey <input type="checkbox"/>	ZK2.5-SF	1SNK706410R0000	50	16.20



Technical data valid for copper conductors only.

ZK2.5-SP PI-Spring terminal blocks

Disconnect with plug - with test sockets - 5.2 mm 0.205 in spacing

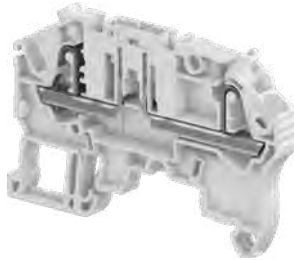

1SNK162039/0014

ZK2.5-SP

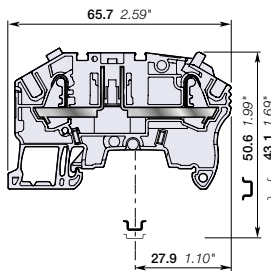

5.2 mm 0.205 in spacing

Description

The flexible solution for fitting the component of your choice in series with our quick-fitting PG5 component holder plug:
 – compatible with components of 8.8 x 3.2 mm 0.346 x 0.125 in, such as resistors, diodes or mini axial fuses.

Ordering details

Description	Color	Type	Part Number	Pkg qty	Weight (1 pce) g
Disconnect with 2 test sockets DIA 2 mm 0.079 in	Grey	<input type="checkbox"/> ZK2.5-SP	1SNK705311R0000	50	11.50

Main technical data

Connecting capacity		IEC	UL - CSA	Mounting instructions	
1 conductor per clamp	Rigid: Solid/Stranded	0.2 ... 4 mm ²	26 ... 12 AWG	Rail	TH 35-7.5, TH 35-15
	Flexible without ferrule	0.22 ... 2.5 mm ²	26 ... 14 AWG	Wire stripping length	11 mm 0.433 in
	Flexible with non insulated ferrule	0.22 ... 2.5 mm ²	26 ... 14 AWG	Tool (for flexible conductor without ferrule)	Flat screwdriver Ø 3.5 mm Ø 0.138 in
	Flexible with insulated ferrule	0.22 ... 2.5 mm ²	26 ... 14 AWG		
2 conductors per clamp	Flexible with twin ferrule	0.22 ... 0.5 mm ²	26 ... 20 AWG		
Rated current / Rated cross section		17 A / 2.5 mm ²	18 A / 12 AWG		
Rated short-time withstand current (1s)		300 A	396 A		
Rated voltage		630 V	300 V		
Impulse withstand voltage		6000 V			
Protection		IP20	NEMA 1		

The connecting capacity data for one Rigid: Solid/Stranded, or one Flexible conductor (when applicable) is a mandatory information required by IEC, UL and CSA standards (Copper conductors). All other data are provided as supplementary information only. For more details, please consult our CB, UL or CSA certificates and technical datasheet available on <http://www.TE.com>

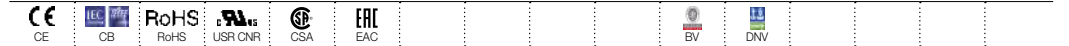

Accessories



Description	Color	Type	Part Number	Pkg qty	Weight (1 pce) g	
1 End stops 5.2 mm 0.205 in	Dark grey	BAZ1	1SNK900002R0000	50	5.30	
2 End sections 2 mm 0.079 in	Dark grey	EK2.5-3P	1SNK705911R0000	20	2.40	
3 Jumper bars	Orange	2 poles 32 A (IEC)	JB5-2	1SNK905302R0000	50	1.30
		3 poles 32 A (IEC)	JB5-3	1SNK905303R0000	50	2.00
		4 poles 32 A (IEC)	JB5-4	1SNK905304R0000	50	2.70
		5 poles 32 A (IEC)	JB5-5	1SNK905305R0000	50	3.50
		10 poles 32 A (IEC)	JB5-10	1SNK905310R0000	30	7.10
		50 poles 32 A (IEC)	JB5-50	1SNK905350R0000	10	36.00
4 Circuit separators 3 mm 0.118 in	Dark grey	CS-R3	1SNK900107R0000	20	6.40	
5 Test adapters	Dark grey	For test plugs DIA 2 mm 0.079 in	TP2	1SNK900203R0000	20	1.70
		For test plugs DIA 4 mm 0.157 in	TP4	1SNK900205R0000	20	2.40
6 Test connectors	Dark grey	5.2 mm 0.205 in spacing	TC5	1SNK900200R0000	10	5.20
		End module, 5.2 mm 0.205 in	TC5-R1	1SNK900201R0000	10	5.20
7 Shield connectors		SHBP	1SNK900601R0000	20	4.10	
8 Component plugs Components in series with circuit	Dark grey	PG5	1SNK900401R0000	20	3.50	
9 Disconnect plugs Equipped with linking bar	Orange	PG5-R1	1SNK900402R0000	20	3.50	
10 Terminal block markers	White	Blank marker	MG-CPM 13 41790	1SNB041790R0512	1960	0.23
		Blank card	MC512	1SNK140000R0000	22	9.00
		Universal wire markers holder	UMH	1SNK149999R0000	20	10.00
	Grey		UMH	1SNK900611R0000	10	0.20

Complete list of accessories is indicated in the terminal block datasheet including end stops. Some accessories such as jumper bars may modify the terminal block's ratings. Complete information available in the accessories section of the catalog.

Technical data valid for copper conductors only.

ZK2.5-SP-4P PI-Spring terminal blocks

Disconnect with plug - with test socket - 5.2 mm 0.205 in spacing

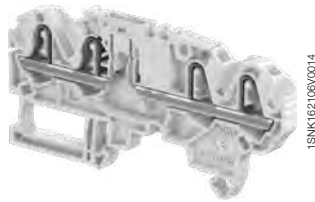

ZK2.5-SP-4P

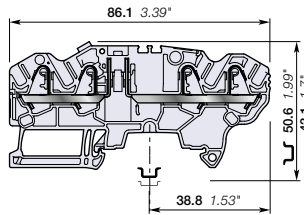

5.2 mm 0.205 in spacing

Description

The flexible solution for fitting the component of your choice in series with our quick-fitting PG5 component holder plug:

- compatible with components of 8.8 x 3.2 mm 0.346 x 0.125 in, such as resistors, diodes or mini axial fuses.

Ordering details

Description	Color	Type	Part Number	Pkg qty	Weight (1 pce) g
Disconnect with 1 test socket DIA 2 mm 0.079 in	Grey <input type="checkbox"/>	ZK2.5-SP-4P	1SNK705313R0000	50	10.67

Main technical data

Connecting capacity		IEC	UL - CSA	Mounting instructions	
1 conductor per clamp	Rigid: Solid/Stranded	0.2 ... 4 mm ²	26 ... 12 AWG	Rail	TH 35-7.5, TH 35-15
	Flexible without ferrule	0.22 ... 2.5 mm ²	26 ... 14 AWG	Wire stripping length	11 mm 0.433 in
	Flexible with non insulated ferrule	0.22 ... 2.5 mm ²	26 ... 14 AWG		
	Flexible with insulated ferrule	0.22 ... 2.5 mm ²	26 ... 14 AWG		
2 conductors per clamp	Flexible with twin ferrule	0.22 ... 0.5 mm ²	26 ... 20 AWG	Tool (for flexible conductor without ferrule)	Flat screwdriver Ø 3.5 mm Ø 0.138 in
Rated current / Rated cross section		17 A / 2.5 mm ²	18 A / 12 AWG		
Rated short-time withstand current (1s)		300 A			
Short Circuit Current Rating (with specific conditions)					
Rated voltage		630 V	300 V		
Impulse withstand voltage		6000 V			
Protection		IP20	NEMA 1		

The connecting capacity data for one Rigid: Solid/Stranded, or one Flexible conductor (when applicable) is a mandatory information required by IEC, UL and CSA standards (Copper conductors). All other data are provided as supplementary information only. For more details, please consult our CB, UL or CSA certificates and technical datasheet available on <http://www.TE.com>

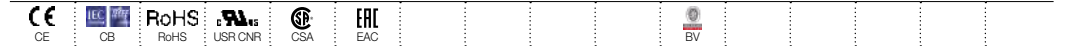

Accessories

Description	Color	Type	Part Number	Pkg qty	Weight (1 pce) g	
1 End stops	Dark grey <input type="checkbox"/>	BAZ1	1SNK900002R0000	50	5.30	
2 End sections	Dark grey <input type="checkbox"/>	EK2.5-S-4P	1SNK705913R0000	20	2.94	
3 Jumper bars	Orange <input type="checkbox"/>	2 poles	JB5-2	1SNK905302R0000	50	1.30
		3 poles	JB5-3	1SNK905303R0000	50	2.00
		4 poles	JB5-4	1SNK905304R0000	50	2.70
		5 poles	JB5-5	1SNK905305R0000	50	3.50
		10 poles	JB5-10	1SNK905310R0000	30	7.10
		50 poles	JB5-50	1SNK905350R0000	10	36.00
4 Circuit separators	Dark grey <input type="checkbox"/>	CS-R3	1SNK900107R0000	20	6.40	
5 Test adapters	Dark grey <input type="checkbox"/>	For test plugs DIA 2 mm 0.079 in	TP2	1SNK900203R0000	20	1.70
		For test plugs DIA 4 mm 0.157 in	TP4	1SNK900205R0000	20	2.40
6 Test connectors	Dark grey <input type="checkbox"/>	5.2 mm 0.205 in spacing	TC5	1SNK900200R0000	10	5.20
		End module, 5.2 mm 0.205 in	TC5-R1	1SNK900201R0000	10	5.20
7 Component plugs	Dark grey <input type="checkbox"/>	PG5	1SNK900401R0000	20	3.50	
8 Disconnect plugs	Orange <input type="checkbox"/>	PG5-R1	1SNK900402R0000	20	3.50	
9 Terminal block markers	White <input type="checkbox"/>	Blank marker	MG-CPM 13 41790	1SNB041790R0512	1960	0.23
		Blank card	MC512	1SNK140000R0000	22	9.00
			MC512PA	1SNK149999R0000	20	10.00
		Universal wire markers holder	Grey <input type="checkbox"/>	UMH	1SNK900611R0000	10

Complete list of accessories is indicated in the terminal block datasheet including end stops.

Some accessories such as jumper bars may modify the terminal block's ratings: Complete information available in the accessories section of the catalog.

Technical data valid for copper conductors only.

ZK2.5-SF PI-Spring terminal blocks

For 5x20 fuses - 6 mm 0.236 in spacing



ZK2.5-SF

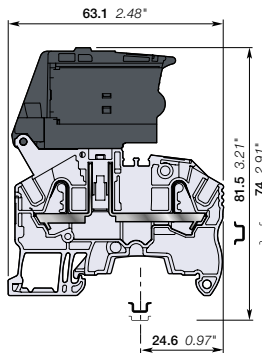

6 mm 0.236 in spacing

Description

Protect your circuits with 5x20 fuse terminal blocks compliant with IEC 60947-7-3 standard (fuse not supplied with the terminal blocks),

- Simplify the distribution thanks to the 2 jumper channels aligned with ZK4-3P feed-through and ZK2.5-S-R1 disconnect terminal blocks.

Ordering details

Description	Color	Type	Part Number	Pkg qty	Weight (1 pce)
Fuse	Grey, dark grey	ZK2.5-SF	1SNK706410R0000	50	16.20

Main technical data

Connecting capacity		IEC	UL - CSA	Mounting instructions	
1 conductor per clamp	Rigid: Solid/Stranded	0.2 ... 4 mm ²	26 ... 12 AWG	Wire stripping length	 TH 35-7,5, TH 35-15 11 mm 0.433 in
	Flexible without ferrule	0.22 ... 2.5 mm ²			
	Flexible with non insulated ferrule	0.22 ... 2.5 mm ²	26 ... 14 AWG		
	Flexible with insulated ferrule	0.22 ... 2.5 mm ²	26 ... 14 AWG		
2 conductors per clamp	Flexible with twin ferrule	0.22 ... 0.5 mm ²	26 ... 20 AWG	Tool (for flexible conductor without ferrule)	 Flat screwdriver Ø 3.5 mm Ø 0.138 in
Rated current / Rated cross section		6.3 A / 2.5 mm ²	16 A / 12 AWG		
Rated short-time withstand current (1s)			396 A		
Rated voltage		500 V	300 V		
Impulse withstand voltage		6000 V			
Protection		IP20	NEMA 1		

The fuse holder must be first disconnected prior any fuse replacement. Mount your fuse safely without touching any active part: put the fuse into the hooks of the fuse holder shutter; at the closing of the shutter, the fuse is perfectly in place in the fuse holder.

Separate arrangement		Assembly composed of 1 fuse terminal block in between non fuse terminal blocks	Overload and short-circuit protection	2.5 W
			Exclusive short-circuit protection	4 W
Compound arrangement		Assembly composed of 5 fuse terminal blocks	Overload and short-circuit protection	1.6 W
			Exclusive short-circuit protection	4 W

The connecting capacity data for one Rigid: Solid/Stranded, or one Flexible conductor (when applicable) is a mandatory information required by IEC, UL and CSA standards (Copper conductors). All other data are provided as supplementary information only. For more details, please consult our CB, UL or CSA certificates and technical datasheet available on <http://www.TE.com>

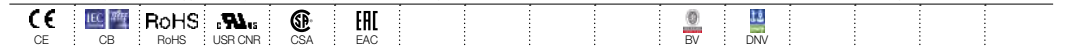

Accessories



Description	Color	Type	Part Number	Pkg qty	Weight (1 pce)	
1 End stops	Dark grey	BAZ1	1SNK900002R0000	50	5.30	
2 End sections	Dark grey	EK2 5-3P	1SNK705911R0000	20	2.40	
3 Jumper bars	Orange	2 poles	JB6-2	1SNK906302R0000	50	1.30
		3 poles	JB6-3	1SNK906303R0000	50	2.10
		4 poles	JB6-4	1SNK906304R0000	50	2.90
		5 poles	JB6-5	1SNK906305R0000	50	3.60
		10 poles	JB6-10	1SNK906310R0000	20	7.40
		50 poles	JB6-50	1SNK906350R0000	10	38.10
4 Circuit separators	Dark grey	CS-R3	1SNK900107R0000	20	6.40	
5 Test adapters	Dark grey	For test plugs DIA 2 mm 0.079 in	TP2	1SNK900203R0000	20	1.70
		For test plugs DIA 4 mm 0.157 in	TP4	1SNK900205R0000	20	2.40
6 Test connectors	Dark grey	TC5-R1	1SNK900201R0000	10	5.20	
7 Spacers	Dark grey	ES-TC6	1SNK900105R0000	10	0.80	
			1SNK150000R0000	22	10.00	
			1SNK159999R0000	20	11.00	
8 Terminal block markers	White	MG-CPM 13 41791	1SNB041791R0612	1680	0.27	
		MC612	1SNK150000R0000	22	10.00	

Complete list of accessories is indicated in the terminal block datasheet including end stops. Some accessories such as jumper bars may modify the terminal block's ratings: Complete information available in the accessories section of the catalog.

Technical data valid for copper conductors only.

ZK2.5-SF-R PI-Spring terminal blocks

For 5x20 fuses - with blown fuse indicator - 6 mm 0.236 in spacing

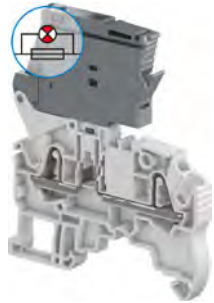

ZK2.5-SF-R

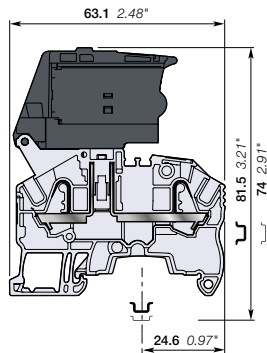

6 mm 0.236 in spacing

Description

- Protect your circuits with 5x20 fuse terminal blocks compliant with IEC 60947-7-3 standard (fuse not supplied with the terminal blocks),
- Simplify the distribution thanks to the 2 jumper channels aligned with ZK4-3P feed-through and ZK2.5-S-R1 disconnect terminal blocks,
- Quickly identify the defective circuit thanks to the blown fuse indicator (with leakage current < 0.5 mA).

Ordering details

Description	Color	Type	Part Number	Pkg qty	Weight (1 pce) g
Fuse with blown fuse indicator 24 ... 110 V AC / DC	Grey, dark grey	ZK2.5-SF-R1	1SNK706411R0000	50	16.30
with blown fuse indicator 115 ... 250 V AC / DC		ZK2.5-SF-R3	1SNK706412R0000	50	16.30

Main technical data

Connecting capacity		IEC	UL - CSA	Mounting instructions	
1 conductor per clamp	Rigid: Solid/Stranded	0.2 ... 4 mm ²	26 ... 12 AWG	Rail	TH 35-7.5, TH 35-15
	Flexible without ferrule	0.22 ... 2.5 mm ²		Wire stripping length	11 mm 0.433 in
	Flexible with non insulated ferrule	0.22 ... 2.5 mm ²	26 ... 14 AWG		
	Flexible with insulated ferrule	0.22 ... 2.5 mm ²	26 ... 14 AWG		
2 conductors per clamp	Flexible with twin ferrule	0.22 ... 0.5 mm ²	26 ... 20 AWG	Tool (for flexible conductor without ferrule)	Flat screwdriver Ø 3.5 mm Ø 0.138 in
Rated current / Rated cross section		6.3 A / 2.5 mm ²	16 A / 12 AWG		
Rated short-time withstand current (1s)			396 A		
Rated voltage		500 V	300 V		
Impulse withstand voltage		6000 V			
Protection		IP20	NEMA 1		

The fuse holder must be first disconnected prior any fuse replacement. Mount your fuse safely without touching any active part: put the fuse into the hooks of the fuse holder shutter; at the closing of the shutter, the fuse is perfectly in place in the fuse holder.

Separate arrangement		Assembly composed of 1 fuse terminal block in between non fuse terminal blocks	Overload and short-circuit protection	2.5 W
			Exclusive short-circuit protection	4 W
Compound arrangement		Assembly composed of 5 fuse terminal blocks	Overload and short-circuit protection	1.6 W
			Exclusive short-circuit protection	4 W

The connecting capacity data for one Rigid: Solid/Stranded, or one Flexible conductor (when applicable) is a mandatory information required by IEC, UL and CSA standards (Copper conductors). All other data are provided as supplementary information only. For more details, please consult our CB, UL or CSA certificates and technical datasheet available on <http://www.TE.com>

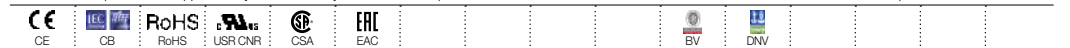

Accessories

Description	Color	Type	Part Number	Pkg qty	Weight (1 pce) g	
1 End stops	Dark grey	BAZ1	1SNK900002R0000	50	5.30	
2 End sections	Dark grey	EK2.5-3P	1SNK705911R0000	20	2.40	
3 Jumper bars	Orange	2 poles	JB6-2	1SNK906302R0000	50	1.30
		3 poles	JB6-3	1SNK906303R0000	50	2.10
		4 poles	JB6-4	1SNK906304R0000	50	2.90
		5 poles	JB6-5	1SNK906305R0000	50	3.60
		10 poles	JB6-10	1SNK906310R0000	20	7.40
		50 poles	JB6-50	1SNK906350R0000	10	38.10
4 Circuit separators	Dark grey	CS-R3	1SNK900107R0000	20	6.40	
5 Test adapters	Dark grey	TP2	1SNK900203R0000	20	1.70	
		TP4	1SNK900205R0000	20	2.40	
6 Test connectors	Dark grey	TC5-R1	1SNK900201R0000	10	5.20	
7 Spacers	Dark grey	ES-TC6	1SNK900105R0000	10	0.80	
	White	MG-CPM 13 41791	1SNB041791R0612	1680	0.27	
		MC612	1SNK150000R0000	22	10.00	
8 Terminal block markers		MC612PA	1SNK159999R0000	20	11.00	

Complete list of accessories is indicated in the terminal block datasheet including end stops.

Some accessories such as jumper bars may modify the terminal block's ratings: Complete information available in the accessories section of the catalog.

Technical data valid for copper conductors only.

ZK2.5-D2 PI-Spring terminal blocks

Double deck with 2 feed-through circuits - 5.2 mm 0.205 in spacing



ZK2.5-D2

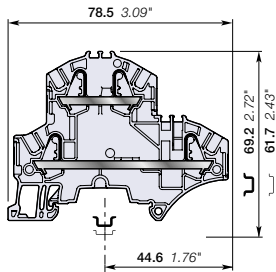

5.2 mm 0.205 in spacing

Description

Combine high performance with compact dimensions:

- 800 V IEC 600 V UL,
- 2 jumper channels and a large input and output marker zone on each deck.

Ordering details

Description	Color	Type	Part Number	Pkg qty	Weight (1 pce) g
Feed-through 2 feed-through circuits	Grey <input type="checkbox"/>	ZK2.5-D2	1SNK705210R0000	50	11.20
	Blue <input type="checkbox"/>	ZK2.5-D2-BL	1SNK705220R0000	50	11.20

Main technical data

Connecting capacity	IEC	UL - CSA	Mounting instructions
1 conductor per clamp	Rigid: Solid/Stranded	0.2 ... 4 mm ²	26 ... 12 AWG
	Flexible without ferrule	0.22 ... 2.5 mm ²	26 ... 14 AWG
	Flexible with non insulated ferrule	0.22 ... 2.5 mm ²	26 ... 14 AWG
	Flexible with insulated ferrule	0.22 ... 2.5 mm ²	26 ... 14 AWG
2 conductors per clamp	Flexible with twin ferrule	0.22 ... 0.5 mm ²	26 ... 20 AWG
Rated current / Rated cross section		24 A / 2.5 mm ²	20 A / 12 AWG
Rated short-time withstand current (1s)		300 A	396 A
Short Circuit Current Rating (with specific conditions)			100 kA
Rated voltage		800 V	600 V
Impulse withstand voltage		8000 V	
Protection		IP20	NEMA 1
Increased safety Ex e		693 V 21 A IEC/EN 60079-7 - IM2 II 2 GD Ex eb I/IC/IIIC	

The connecting capacity data for one Rigid: Solid/Stranded, or one Flexible conductor (when applicable) is a mandatory information required by IEC, UL and CSA standards (Copper conductors). All other data are provided as supplementary information only. For more details, please consult our CB, UL or CSA certificates and technical datasheet available on <http://www.TE.com>



Accessories

Description	Color	Type	Part Number	Pkg qty	Weight (1 pce) g	
1 End stops 10 mm 0.394 in	Dark grey <input type="checkbox"/>	BAZH1	1SNK900102R0000	20	24.00	
2 End sections 2 mm 0.079 in	Dark grey <input type="checkbox"/>	EK2.5-D2	1SNK705960R0000	20	3.40	
3 Jumper bars	Orange <input type="checkbox"/>	2 poles 32 A (IEC)	JB5-2	1SNK905302R0000	50	1.30
		3 poles 32 A (IEC)	JB5-3	1SNK905303R0000	50	2.00
		4 poles 32 A (IEC)	JB5-4	1SNK905304R0000	50	2.70
		5 poles 32 A (IEC)	JB5-5	1SNK905305R0000	50	3.50
		10 poles 32 A (IEC)	JB5-10	1SNK905310R0000	30	7.10
		50 poles 32 A (IEC)	JB5-50	1SNK905350R0000	10	36.00
4 Test adapters	Dark grey <input type="checkbox"/>	For test plugs DIA 2 mm 0.079 in	TP2	1SNK900203R0000	20	1.70
		For test plugs DIA 4 mm 0.157 in	TP4	1SNK900205R0000	20	2.40
5 Test connectors 5.2 mm 0.205 in spacing	Dark grey <input type="checkbox"/>	End module, 5.2 mm 0.205 in	TC5	1SNK900200R0000	10	5.20
			TC5-R1	1SNK900201R0000	10	5.20
6 Shield connectors		SHB	1SNK900602R0000	20	4.90	
7 Label holders	Dark grey <input type="checkbox"/>	LH-J	1SNK900606R0000	100	0.73	
8 Terminal block markers	White <input type="checkbox"/>	Blank marker	MG-CPM 13 41790	1SNB041790R0512	1960	0.23
		Blank card	MC512	1SNK140000R0000	22	9.00
			MC512PA	1SNK149999R0000	20	10.00
	Universal wire markers holder	Grey <input type="checkbox"/>	UMH	1SNK900611R0000	10	0.20

Complete list of accessories is indicated in the terminal block datasheet including end stops. Some accessories such as jumper bars may modify the terminal block's ratings: Complete information available in the accessories section of the catalog.



Ground PI-Spring terminal blocks

Description	Color	Type	Part Number	Pkg qty	Weight (1 pce) g
Ground Profile aligned with ZK2.5-D2 and ZK2.5-D1	Green-yellow <input type="checkbox"/>	ZK2.5-D1-PE	1SNK705250R0000	20	15.70

Technical data valid for copper conductors only.

ZK2.5-D1 PI-Spring terminal blocks

Double deck with 1 feed-through circuit - 5.2 mm 0.205 in spacing



1SNK162078V0014

ZK2.5-D1

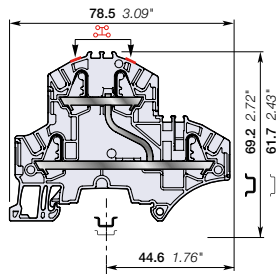

5.2 mm 0.205 in spacing

Description

– Find the same functionalities as ZK2.5-D2 and ease one potential distribution on 4 independent connections.

Ordering details

Description	Color	Type	Part Number	Pkg qty	Weight (1 pce) g
Feed-through 1 feed-through circuit	Grey <input type="checkbox"/>	ZK2.5-D1	1SNK705211R0000	50	11.20

Main technical data

Connecting capacity		IEC	UL - CSA	Mounting instructions	
1 conductor per clamp	Rigid: Solid/Stranded	0.2 ... 4 mm ²	26 ... 12 AWG	Rail	TH 35-7.5, TH 35-15
	Flexible without ferrule	0.22 ... 2.5 mm ²		Wire stripping length	11 mm 0.433 in
	Flexible with non insulated ferrule	0.22 ... 2.5 mm ²	26 ... 14 AWG		
	Flexible with insulated ferrule	0.22 ... 2.5 mm ²	26 ... 14 AWG		
2 conductors per clamp	Flexible with twin ferrule	0.22 ... 0.5 mm ²	26 ... 20 AWG	Tool (for flexible conductor without ferrule)	Flat screwdriver Ø 3.5 mm Ø 0.138 in
Rated current / Rated cross section		24 A / 2.5 mm ²	20 A / 12 AWG		
Rated short-time withstand current (1s)		300 A	396 A		
Short Circuit Current Rating (with specific conditions)			100 kA		
Rated voltage		800 V	600 V		
Impulse withstand voltage		8000 V			
Protection		IP20	NEMA 1		
Increased safety Ex e		693 V 21 A IEC/EN 60079-7 - IM2 II 2 GD Ex eb I/II/C/III/C			

The connecting capacity data for one Rigid: Solid/Stranded, or one Flexible conductor (when applicable) is a mandatory information required by IEC, UL and CSA standards (Copper conductors). All other data are provided as supplementary information only. For more details, please consult our CB, UL or CSA certificates and technical datasheet available on <http://www.TE.com>



Accessories

Description	Color	Type	Part Number	Pkg qty	Weight (1 pce) g
1 End stops 10 mm 0.394 in	Dark grey <input type="checkbox"/>	BAZH1	1SNK900102R0000	20	24.00
2 End sections 2 mm 0.079 in	Dark grey <input type="checkbox"/>	EK2.5-D2	1SNK705960R0000	20	3.40
3 Jumper bars 2 poles 32 A (IEC) 3 poles 32 A (IEC) 4 poles 32 A (IEC) 5 poles 32 A (IEC) 10 poles 32 A (IEC) 50 poles 32 A (IEC)	Orange <input type="checkbox"/>	JB5-2	1SNK905302R0000	50	1.30
		JB5-3	1SNK905303R0000	50	2.00
		JB5-4	1SNK905304R0000	50	2.70
		JB5-5	1SNK905305R0000	50	3.50
		JB5-10	1SNK905310R0000	30	7.10
4 Test adapters For test plugs DIA 2 mm 0.079 in For test plugs DIA 4 mm 0.157 in	Dark grey <input type="checkbox"/>	TP2	1SNK900203R0000	20	1.70
		TP4	1SNK900205R0000	20	2.40
5 Test connectors 5.2 mm 0.205 in spacing End module, 5.2 mm 0.205 in	Dark grey <input type="checkbox"/>	TC5	1SNK900200R0000	10	5.20
		TC5-R1	1SNK900201R0000	10	5.20
6 Shield connectors		SHB	1SNK900602R0000	20	4.90
7 Label holders	Dark grey <input type="checkbox"/>	LH-J	1SNK900606R0000	100	0.73
8 Terminal block markers Blank marker Blank card Universal wire markers holder	White <input type="checkbox"/>	MG-CPM 13 41790	1SNB041790R0512	1960	0.23
		MC512	1SNK140000R0000	22	9.00
		MC512PA	1SNK149999R0000	20	10.00
	Grey <input type="checkbox"/>	UMH	1SNK900611R0000	10	0.20

Complete list of accessories is indicated in the terminal block datasheet including end stops. Some accessories such as jumper bars may modify the terminal block's ratings: Complete information available in the accessories section of the catalog.



Ground PI-Spring terminal blocks

Description	Color	Type	Part Number	Pkg qty	Weight (1 pce) g
Ground Profile aligned with ZK2.5-D2 and ZK2.5-D1	Green-yellow <input type="checkbox"/>	ZK2.5-D1-PE	1SNK705250R0000	20	15.70

Technical data valid for copper conductors only.

ZK2.5-D2-PE PI-Spring terminal blocks

Double deck with 1 feed-through circuit and 1 ground circuit - 5.2 mm 0.205 in spacing



1SNK162079R0014

ZK2.5-D2-PE

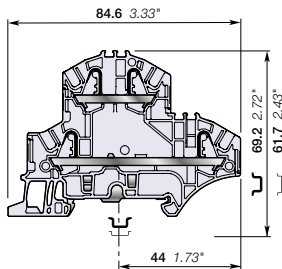

5.2 mm 0.205 in spacing

Description

Combine high performance with compact dimensions:

- 800 V IEC 600 V UL,
- 1 feed through circuit and 1 ground circuit in just 5.2 mm 0.205 in spacing,
- 2 jumper channels and a large input and output marker zone on each deck,
- designed for easy wiring.

Ordering details

Description	Color	Type	Part Number	Pkg qty	Weight (1 pce)
Feed-through + ground	Grey, Green-yellow	ZK2.5-D2-PE	1SNK705212R0000	20	15.70

Main technical data

Connecting capacity		IEC	UL - CSA	Mounting instructions	
1 conductor per clamp	Rigid: Solid/Stranded	0.2 ... 4 mm ²	26 ... 12 AWG	Rail	TH 35-7.5, TH 35-15
	Flexible without ferrule	0.22 ... 2.5 mm ²	26 ... 12 AWG	Wire stripping length	11 mm 0.433 in
	Flexible with non insulated ferrule	0.22 ... 2.5 mm ²	26 ... 14 AWG	Tool (for flexible conductor without ferrule)	Flat screwdriver Ø 3.5 mm Ø 0.138 in
	Flexible with insulated ferrule	0.22 ... 2.5 mm ²	26 ... 14 AWG		
2 conductors per clamp	Flexible with twin ferrule	0.22 ... 0.5 mm ²	26 ... 20 AWG		
Rated current / Rated cross section		24 A / 2.5 mm ²	20 A / 12 AWG		
Rated short-time withstand current (1s)		300 A	396 A		
Short Circuit Current Rating (with specific conditions)					
Rated voltage		800 V	600 V		
Impulse withstand voltage		8000 V			
Protection		IP20	NEMA 1		
Increased safety Ex e		693 V 21 A IEC/EN 60079-7 - IM2 II 2 GD Ex eb IIC/IIC			

The connecting capacity data for one Rigid: Solid/Stranded, or one Flexible conductor (when applicable) is a mandatory information required by IEC, UL and CSA standards (Copper conductors). All other data are provided as supplementary information only. For more details, please consult our CB, UL or CSA certificates and technical datasheet available on <http://www.TE.com>



Accessories

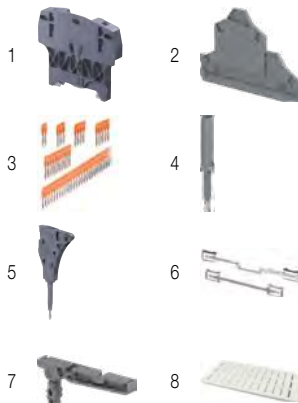

Description	Color	Type	Part Number	Pkg qty	Weight (1 pce)	
1 End stops	Dark grey	BAZH1	1SNK900102R0000	20	24.00	
2 End sections	Dark grey	EK2.5-D2	1SNK705960R0000	20	3.40	
3 Jumper bars	Orange	2 poles	JB5-2	1SNK905302R0000	50	1.30
		3 poles	JB5-3	1SNK905303R0000	50	2.00
		4 poles	JB5-4	1SNK905304R0000	50	2.70
		5 poles	JB5-5	1SNK905305R0000	50	3.50
		10 poles	JB5-10	1SNK905310R0000	30	7.10
		50 poles	JB5-50	1SNK905350R0000	10	36.00
4 Test adapters	Dark grey	For test plugs DIA 2 mm 0.079 in	TP2	1SNK900203R0000	20	1.70
		For test plugs DIA 4 mm 0.157 in	TP4	1SNK900205R0000	20	2.40
5 Test connectors	Dark grey	5.2 mm 0.205 in spacing	TC5	1SNK900200R0000	10	5.20
		End module, 5.2 mm 0.205 in	TC5-R1	1SNK900201R0000	10	5.20
6 Shield connectors		SHB	1SNK900602R0000	20	4.90	
7 Label holders	Dark grey	LH-J	1SNK900606R0000	100	0.73	
8 Terminal block markers	White	Blank marker	MG-CPM 13 41790	1SNB041790R0512	1960	0.23
		Blank card	MC512	1SNK140000R0000	22	9.00
			MC512PA	1SNK149999R0000	20	10.00
	Universal wire markers holder	Grey	UMH	1SNK900611R0000	10	0.20

Complete list of accessories is indicated in the terminal block datasheet including end stops. Some accessories such as jumper bars may modify the terminal block's ratings: Complete information available in the accessories section of the catalog.

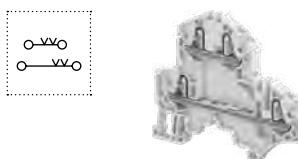

Feed-through PI-Spring terminal blocks

Description	Color	Type	Part Number	Pkg qty	Weight (1 pce)
Feed-through	Grey	ZK2.5-D2	1SNK705210R0000	50	11.20

Technical data valid for copper conductors only.

ZK2.5-D1-PE PI-Spring terminal blocks

Double deck with 1 ground circuit - 5.2 mm 0.205 in spacing

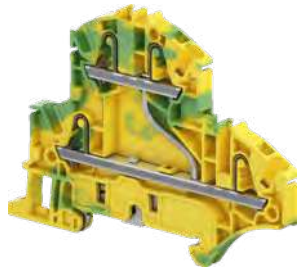

1SNK162049S0201

ZK2.5-D1-PE

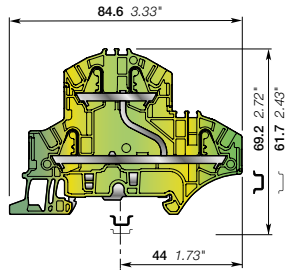

5.2 mm 0.205 in spacing

Description

Improve the safety of your installation in the event of a short-circuit thanks to our screwless rail contact:

- Rail contact non operator dependent,
- Performances above the requirements of the IEC 60947-7-2 terminal block standard,
- Secured snap on or off the rail,
- Profile aligned with ZK2.5-D2.

Ordering details

Description	Color	Type	Part Number	Pkg qty	Weight (1 pce) g
Ground 1 ground circuit	Green-yellow	ZK2.5-D1-PE	1SNK705250R0000	20	15.70

Main technical data

Connecting capacity		IEC	UL - CSA	Mounting instructions	
1 conductor per clamp	Rigid: Solid/Stranded	0.2 ... 4 mm²	26 ... 12 AWG	Rail	TH 35-7.5, TH 35-15
	Flexible without ferrule	0.22 ... 2.5 mm²		Wire stripping length	11 mm 0.433 in
	Flexible with non insulated ferrule	0.22 ... 2.5 mm²	26 ... 14 AWG		
	Flexible with insulated ferrule	0.22 ... 2.5 mm²	26 ... 14 AWG		
Rated cross section		2.5 mm²	12 AWG	Tool (for flexible conductor without ferrule)	Flat screwdriver Ø 3.5 mm Ø 0.138 in
Rated short-time withstand current (1s)		300 A	396 A		
Protection		IP20	NEMA 1		
Explosive atmosphere classification		IM2 II 2 GD Ex eb I/IC/IIIC - Class I, Zone 1, AEx e II, Ex e II U			

The connecting capacity data for one Rigid: Solid/Stranded, or one Flexible conductor (when applicable) is a mandatory information required by IEC, UL and CSA standards (Copper conductors). All other data are provided as supplementary information only. For more details, please consult our CB, UL or CSA certificates and technical datasheet available on <http://www.TE.com>



Accessories

Description	Color	Type	Part Number	Pkg qty	Weight (1 pce) g
1 End stops 10 mm 0.394 in	Dark grey	BAZH1	1SNK900102R0000	20	24.00
2 End sections 2 mm 0.079 in	Dark grey	EK2.5-D2	1SNK705960R0000	20	3.40
3 Test adapters For test plugs DIA 2 mm 0.079 in For test plugs DIA 4 mm 0.157 in	Dark grey	TP2	1SNK900203R0000	20	1.70
		TP4	1SNK900205R0000	20	2.40
4 Test connectors 5.2 mm 0.205 in spacing End module, 5.2 mm 0.205 in	Dark grey	TC5	1SNK900200R0000	10	5.20
		TC5-R1	1SNK900201R0000	10	5.20
5 Shield connectors		SHB	1SNK900602R0000	20	4.90
6 Label holders	Dark grey	LH-J	1SNK900606R0000	100	0.73
7 Terminal block markers Blank marker Blank card Universal wire markers holder	White	MG-CPM 13 41790	1SNB041790R0512	1960	0.23
		MC512	1SNK140000R0000	22	9.00
		MC512PA	1SNK149999R0000	20	10.00
	Grey	UMH	1SNK900611R0000	10	0.20

Complete list of accessories is indicated in the terminal block datasheet including end stops.

Some accessories such as jumper bars may modify the terminal block's ratings: Complete information available in the accessories section of the catalog.

Technical data valid for copper conductors only.

ZK2.5-T3 PI-Spring terminal blocks

Triple deck with 3 feed-through circuits - 5.2 mm 0.205 in spacing



ZK2.5-T3

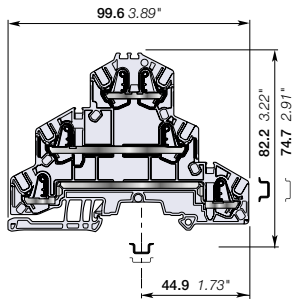

5.2 mm 0.205 in spacing

Description

Combine high performance with compact dimensions in just 5.2 mm 0.205 in spacing:
 - 500 V IEC 300 V UL,
 - 1 jumper channel and a large input and output marker zone on each deck.

Ordering details

Description	Color	Type	Part Number	Pkg qty	Weight (1 pce) g
Feed-through 3 feed-through circuits	Grey <input type="checkbox"/>	ZK2.5-T3	1SNK705510R0000	25	17.33

Main technical data

Connecting capacity		IEC	UL - CSA	Mounting instructions	
1 conductor per clamp	Rigid: Solid/Stranded	0.2 ... 4 mm ²	26 ... 12 AWG	Rail	TH 35-7.5, TH 35-15
	Flexible without ferrule	0.22 ... 2.5 mm ²		Wire stripping length	11 mm 0.433 in
	Flexible with non insulated ferrule	0.22 ... 2.5 mm ²	26 ... 14 AWG	Tool (for flexible conductor without ferrule)	Flat screwdriver Ø 3.5 mm Ø 0.138 in
	Flexible with insulated ferrule	0.22 ... 2.5 mm ²	26 ... 14 AWG		
2 conductors per clamp	Flexible with twin ferrule	0.22 ... 0.5 mm ²	26 ... 20 AWG		
Rated current / Rated cross section		22 A / 2.5 mm ²	20 A / 12 AWG		
Rated short-time withstand current (1s)		300 A			
Short Circuit Current Rating (with specific conditions)					
Rated voltage		500 V	300 V		
Impulse withstand voltage		8000 V			
Protection		IP20	NEMA 1		
Increased safety Ex e		440 V 20 A IEC/EN 60079-7 - IM2 II 2 GD Ex eb IIC/IIC			

The connecting capacity data for one Rigid: Solid/Stranded, or one Flexible conductor (when applicable) is a mandatory information required by IEC, UL and CSA standards (Copper conductors). All other data are provided as supplementary information only. For more details, please consult our CB, UL or CSA certificates and technical datasheet available on <http://www.TE.com>



Accessories

Description	Color	Type	Part Number	Pkg qty	Weight (1 pce) g	
1 End stops 10 mm 0.394 in	Dark grey <input type="checkbox"/>	BAZH1	1SNK900102R0000	20	24.00	
2 End sections 0.8 mm 0.031 in	Dark grey <input type="checkbox"/>	EK2.5-T3	1SNK705961R0000	20	4.76	
3 Jumper bars	Orange <input type="checkbox"/>	2 poles 32 A (IEC)	JB5-2	1SNK905302R0000	50	1.30
		3 poles 32 A (IEC)	JB5-3	1SNK905303R0000	50	2.00
		4 poles 32 A (IEC)	JB5-4	1SNK905304R0000	50	2.70
		5 poles 32 A (IEC)	JB5-5	1SNK905305R0000	50	3.50
		10 poles 32 A (IEC)	JB5-10	1SNK905310R0000	30	7.10
		50 poles 32 A (IEC)	JB5-50	1SNK905350R0000	10	36.00
4 Test adapters	Dark grey <input type="checkbox"/>	For test plugs DIA 2 mm 0.079 in	TP2	1SNK900203R0000	20	1.70
		For test plugs DIA 4 mm 0.157 in	TP4	1SNK900205R0000	20	2.40
5 Test connectors 5.2 mm 0.205 in spacing	Dark grey <input type="checkbox"/>		TC5	1SNK900200R0000	10	5.20
		End module, 5.2 mm 0.205 in	TC5-R1	1SNK900201R0000	10	5.20
6 Label holders	Dark grey <input type="checkbox"/>		LH-J	1SNK900606R0000	100	0.73
			MG-CPM 13 41790	1SNB041790R0512	1960	0.23
7 Terminal block markers	White <input type="checkbox"/>		MC512	1SNK140000R0000	22	9.00
			MC512PA	1SNK149999R0000	20	10.00
		Universal wire markers holder	Grey <input type="checkbox"/>	UMH	1SNK900611R0000	10

Complete list of accessories is indicated in the terminal block datasheet including end stops.
 Some accessories such as jumper bars may modify the terminal block's ratings: Complete information available in the accessories section of the catalog.



Ground PI-Spring terminal blocks

Description	Color	Type	Part Number	Pkg qty	Weight (1 pce) g
Ground	Green-yellow <input type="checkbox"/>	ZK2.5-T1-PE	1SNK705550R0000	25	21.53

Technical data valid for copper conductors only.

ZK2.5-T1 PI-Spring terminal blocks

Triple deck with 1 feed-through circuit - 5.2 mm 0.205 in spacing



ZK2.5-T1

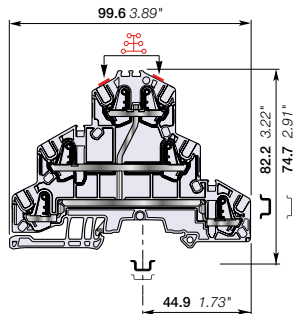

5.2 mm 0.205 in spacing

Description

Find the same functionalities as ZK2.5-T3 and ease one potential distribution on 6 independent connections.

Ordering details

Description	Color	Type	Part Number	Pkg qty	Weight (1 pce) g
Feed-through 1 feed-through circuit	Grey <input type="checkbox"/>	ZK2.5-T1	1SNK705511R0000	25	17.33

Main technical data

Connecting capacity	IEC	UL - CSA	Mounting instructions		
1 conductor per clamp	Rigid: Solid/Stranded	0.2 ... 4 mm ²	26 ... 12 AWG	Rail	TH 35-7.5, TH 35-15
	Flexible without ferrule	0.22 ... 2.5 mm ²	26 ... 14 AWG	Wire stripping length	11 mm 0.433 in
	Flexible with non insulated ferrule	0.22 ... 2.5 mm ²	26 ... 14 AWG	Tool (for flexible conductor without ferrule)	Flat screwdriver Ø 3.5 mm Ø 0.138 in
	Flexible with insulated ferrule	0.22 ... 2.5 mm ²	26 ... 14 AWG		
2 conductors per clamp	Flexible with twin ferrule	0.22 ... 0.5 mm ²	26 ... 20 AWG		
Rated current / Rated cross section		22 A / 2.5 mm ²	20 A / 12 AWG		
Rated short-time withstand current (1s)		300 A			
Short Circuit Current Rating (with specific conditions)					
Rated voltage		500 V	300 V		
Impulse withstand voltage		8000 V			
Protection		IP20	NEMA 1		
Increased safety Ex e		440 V 20 A IEC/EN 60079-7 - IM2 II 2 GD Ex eb I/IC/IIIC			

The connecting capacity data for one Rigid: Solid/Stranded, or one Flexible conductor (when applicable) is a mandatory information required by IEC, UL and CSA standards (Copper conductors). All other data are provided as supplementary information only. For more details, please consult our CB, UL or CSA certificates and technical datasheet available on <http://www.TE.com>



Accessories

Description	Color	Type	Part Number	Pkg qty	Weight (1 pce) g	
1 End stops	Dark grey <input type="checkbox"/>	BAZH1	1SNK900102R0000	20	24.00	
2 End sections	Dark grey <input type="checkbox"/>	EK2.5-T3	1SNK705961R0000	20	4.76	
3 Jumper bars	Orange <input type="checkbox"/>	2 poles	JB5-2	1SNK905302R0000	50	1.30
		3 poles	JB5-3	1SNK905303R0000	50	2.00
		4 poles	JB5-4	1SNK905304R0000	50	2.70
		5 poles	JB5-5	1SNK905305R0000	50	3.50
		10 poles	JB5-10	1SNK905310R0000	30	7.10
4 Test adapters	Dark grey <input type="checkbox"/>	For test plugs DIA 2 mm 0.079 in	TP2	1SNK900203R0000	20	1.70
		For test plugs DIA 4 mm 0.157 in	TP4	1SNK900205R0000	20	2.40
5 Test connectors	Dark grey <input type="checkbox"/>	5.2 mm 0.205 in spacing	TC5	1SNK900200R0000	10	5.20
		End module, 5.2 mm 0.205 in	TC5-R1	1SNK900201R0000	10	5.20
6 Label holders	Dark grey <input type="checkbox"/>	LH-J	1SNK900606R0000	100	0.73	
7 Terminal block markers	White <input type="checkbox"/>	Blank marker	MG-CPM 13 41790	1SNB041790R0512	1960	0.23
		Blank card	MC512	1SNK140000R0000	22	9.00
	Grey <input type="checkbox"/>		MC512PA	1SNK149999R0000	20	10.00
		Universal wire markers holder	UMH	1SNK900611R0000	10	0.20

Complete list of accessories is indicated in the terminal block datasheet including end stops. Some accessories such as jumper bars may modify the terminal block's ratings. Complete information available in the accessories section of the catalog.



Ground PI-Spring terminal blocks

Description	Color	Type	Part Number	Pkg qty	Weight (1 pce) g
Ground	Green-yellow <input type="checkbox"/>	ZK2.5-T1-PE	1SNK705550R0000	25	21.53

Technical data valid for copper conductors only.

ZK2.5-L-L-PE PI-Spring terminal blocks

Triple deck with 2 feed-through circuits and 1 ground circuit - 5.2 mm 0.205 in spacing



1SNK162112R0014

ZK2.5-L-L-PE

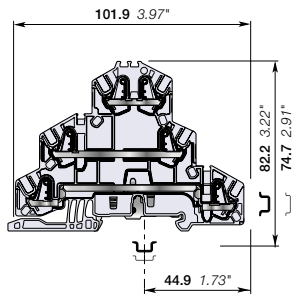

5.2 mm 0.205 in spacing

Description

Combine high performance with compact dimensions:

- 500V IEC 300 V UL,
- 2 feed through circuits and 1 ground circuit in just 5.2 mm 0.205 in spacing,
- 1 jumper channel and a large input and output marker zone on each deck,
- designed for easy wiring.

Ordering details

Description	Color	Type	Part Number	Pkg qty	Weight (1 pce)
Feed-through + ground	Grey, Green-yellow	ZK2.5-L-L-PE	1SNK705512R0000	25	21.38 g

Main technical data

Connecting capacity		IEC	UL - CSA	Mounting instructions	
1 conductor per clamp	Rigid: Solid/Stranded	0.2 ... 4 mm ²	26 ... 12 AWG	Rail	TH 35-7.5, TH 35-15
	Flexible without ferrule	0.22 ... 2.5 mm ²	26 ... 12 AWG	Wire stripping length	11 mm 0.433 in
	Flexible with non insulated ferrule	0.22 ... 2.5 mm ²	26 ... 14 AWG	Tool (for flexible conductor without ferrule)	Flat screwdriver Ø 3.5 mm Ø 0.138 in
	Flexible with insulated ferrule	0.22 ... 2.5 mm ²	26 ... 14 AWG		
2 conductors per clamp	Flexible with twin ferrule	0.22 ... 0.5 mm ²	26 ... 20 AWG		
Rated current / Rated cross section		22 A / 2.5 mm ²	20 A / 12 AWG		
Rated short-time withstand current (1s)		300 A	396 A		
Short Circuit Current Rating (with specific conditions)					
Rated voltage		500 V	300 V		
Impulse withstand voltage		8000 V			
Protection		IP20	NEMA 1		
Increased safety Ex e		440 V 20 A IEC/EN 60079-7 - IM2 II 2 GD Ex eb IIC/IIC			

The connecting capacity data for one Rigid: Solid/Stranded, or one Flexible conductor (when applicable) is a mandatory information required by IEC, UL and CSA standards (Copper conductors). All other data are provided as supplementary information only. For more details, please consult our CB, UL or CSA certificates and technical datasheet available on <http://www.TE.com>



Accessories

Description	Color	Type	Part Number	Pkg qty	Weight (1 pce)	
1 End stops	Dark grey	BAZH1	1SNK900102R0000	20	24.00	
2 End sections	Dark grey	EK2.5-T3	1SNK705961R0000	20	4.76	
3 Jumper bars	Orange	2 poles 32 A (IEC)	JB5-2	1SNK905302R0000	50	1.30
		3 poles 32 A (IEC)	JB5-3	1SNK905303R0000	50	2.00
		4 poles 32 A (IEC)	JB5-4	1SNK905304R0000	50	2.70
		5 poles 32 A (IEC)	JB5-5	1SNK905305R0000	50	3.50
		10 poles 32 A (IEC)	JB5-10	1SNK905310R0000	30	7.10
4 Test adapters	Dark grey	For test plugs DIA 2 mm 0.079 in	TP2	1SNK900203R0000	20	1.70
		For test plugs DIA 4 mm 0.157 in	TP4	1SNK900205R0000	20	2.40
5 Test connectors	Dark grey	5.2 mm 0.205 in spacing	TC5	1SNK900200R0000	10	5.20
		End module, 5.2 mm 0.205 in	TC5-R1	1SNK900201R0000	10	5.20
6 Label holders	Dark grey	LH-J	1SNK900606R0000	100	0.73	
7 Terminal block markers	White	Blank marker	MG-CPM 13 41790	1SNB041790R0512	1960	0.23
		Blank card	MC512	1SNK140000R0000	22	9.00
		Universal wire markers holder	UMH	1SNK149999R0000	20	10.00
	Grey		UMH	1SNK900611R0000	10	0.20

Complete list of accessories is indicated in the terminal block datasheet including end stops. Some accessories such as jumper bars may modify the terminal block's ratings: Complete information available in the accessories section of the catalog.

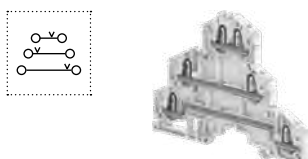

Feed-through PI-Spring terminal blocks

Description	Color	Type	Part Number	Pkg qty	Weight (1 pce)
Feed-through	Grey	ZK2.5-T3	1SNK705510R0000	25	17.33 g

Technical data valid for copper conductors only.

ZK2.5-L-N-PE PI-Spring terminal blocks

Triple deck with 2 feed-through circuits and 1 ground circuit - 5.2 mm 0.205 in spacing



1SNK162113W0014

ZK2.5-L-N-PE

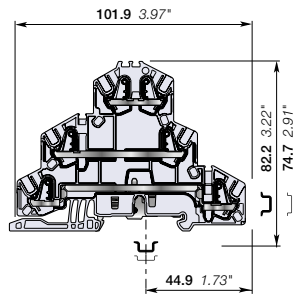

5.2 mm 0.205 in spacing

Description

Combine high performance with compact dimensions:

- 500 V IEC 300 V UL,
- 2 feed through circuits, phase and neutral, and 1 ground circuit in just 5.2 mm 0.205 in spacing,
- 1 jumper channel and a large input and output marker zone on each deck,
- designed for easy wiring.

Ordering details

Description	Color	Type	Part Number	Pkg qty	Weight (1 pce) g
Feed-through + ground	Blue, grey, Green-yellow	ZK2.5-L-N-PE	1SNK705513R0000	25	21.38

Main technical data

Connecting capacity		IEC	UL - CSA	Mounting instructions	
1 conductor per clamp	Rigid: Solid/Stranded	0.2 ... 4 mm²	26 ... 12 AWG	Rail	 TH 35-7.5, TH 35-15
	Flexible without ferrule	0.22 ... 2.5 mm²	26 ... 14 AWG		
	Flexible with non insulated ferrule	0.22 ... 2.5 mm²	26 ... 14 AWG	Wire stripping length	 11 mm 0.433 in
	Flexible with insulated ferrule	0.22 ... 2.5 mm²	26 ... 14 AWG		
2 conductors per clamp	Flexible with twin ferrule	0.22 ... 0.5 mm²	26 ... 20 AWG	Tool (for flexible conductor without ferrule)	 Flat screwdriver Ø 3.5 mm Ø 0.138 in
Rated current / Rated cross section		22 A / 2.5 mm²	20 A / 12 AWG		
Rated short-time withstand current (1s)		300 A	396 A		
Short Circuit Current Rating (with specific conditions)					
Rated voltage		500 V	300 V		
Impulse withstand voltage		8000 V			
Protection		IP20	NEMA 1		
Increased safety Ex e		440 V 20 A IEC/EN 60079-7 - IM2 II 2 GD Ex eb I/IC/IIIC			

The connecting capacity data for one Rigid: Solid/Stranded, or one Flexible conductor (when applicable) is a mandatory information required by IEC, UL and CSA standards (Copper conductors). All other data are provided as supplementary information only. For more details, please consult our CB, UL or CSA certificates and technical datasheet available on <http://www.TE.com>

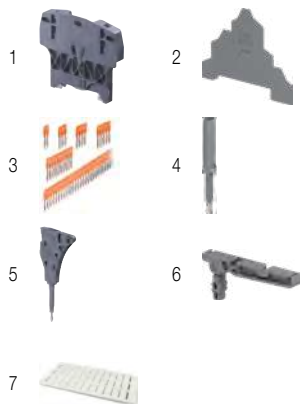

Accessories

Description	Color	Type	Part Number	Pkg qty	Weight (1 pce) g	
1 End stops	Dark grey	BAZH1	1SNK900102R0000	20	24.00	
2 End sections	Dark grey	EK2.5-T3	1SNK705961R0000	20	4.76	
3 Jumper bars	Orange	2 poles	JB5-2	1SNK905302R0000	50	1.30
		3 poles	JB5-3	1SNK905303R0000	50	2.00
		4 poles	JB5-4	1SNK905304R0000	50	2.70
		5 poles	JB5-5	1SNK905305R0000	50	3.50
		10 poles	JB5-10	1SNK905310R0000	30	7.10
		50 poles	JB5-50	1SNK905350R0000	10	36.00
4 Test adapters	Dark grey	For test plugs DIA 2 mm 0.079 in	TP2	1SNK900203R0000	20	1.70
		For test plugs DIA 4 mm 0.157 in	TP4	1SNK900205R0000	20	2.40
5 Test connectors	Dark grey	5.2 mm 0.205 in spacing	TC5	1SNK900200R0000	10	5.20
		End module, 5.2 mm 0.205 in	TC5-R1	1SNK900201R0000	10	5.20
6 Label holders	Dark grey	LH-J	1SNK900606R0000	100	0.73	
7 Terminal block markers	White	Blank marker	MG-CPM 13 41790	1SNB041790R0512	1960	0.23
		Blank card	MC512	1SNK140000R0000	22	9.00
			MC512PA	1SNK149999R0000	20	10.00
		Universal wire markers holder	Grey	UMH	1SNK900611R0000	10

Complete list of accessories is indicated in the terminal block datasheet including end stops. Some accessories such as jumper bars may modify the terminal block's ratings: Complete information available in the accessories section of the catalog.

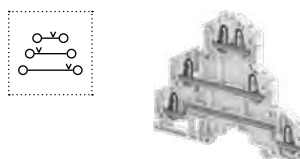

Feed-through PI-Spring terminal blocks

Description	Color	Type	Part Number	Pkg qty	Weight (1 pce) g
Feed-through	Grey	ZK2.5-T3	1SNK705510R0000	25	17.33

Technical data valid for copper conductors only.



ZK2.5-T1-PE PI-Spring terminal blocks

Triple deck with 1 ground circuit - 5.2 mm 0.205 in spacing

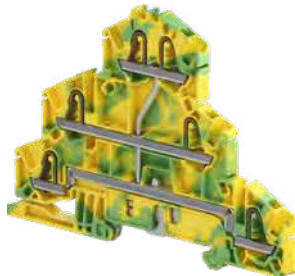

1SNK16211V0014

ZK2.5-T1-PE

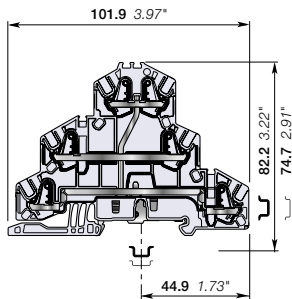

5.2 mm 0.205 in spacing

Description

Improve the safety of your installation in the event of a short-circuit thanks to our screwless rail contact:

- Rail contact non operator dependent,
- Performances above the requirements of the IEC 60947-7-2 terminal block standard,
- Secured snap on or off the rail,
- Profile aligned with ZK2.5-T3,
- 1 jumper channel on bottom and middle decks.

Ordering details

Description	Color	Type	Part Number	Pkg qty	Weight (1 pce) g
Ground 1 ground circuit	Green-yellow	ZK2.5-T1-PE	1SNK705550R0000	25	21.53

Main technical data

Connecting capacity		IEC	UL - CSA
1 conductor per clamp	Rigid: Solid/Stranded	0.2 ... 4 mm ²	26 ... 12 AWG
	Flexible without ferrule	0.22 ... 2.5 mm ²	
	Flexible with non insulated ferrule	0.22 ... 2.5 mm ²	26 ... 14 AWG
	Flexible with insulated ferrule	0.22 ... 2.5 mm ²	26 ... 14 AWG
Rated cross section		2.5 mm ²	12 AWG
Rated short-time withstand current (1s)		300 A	396 A
Protection		IP20	NEMA 1

Mounting instructions

Rail		TH 35-7.5, TH 35-15
Wire stripping length		11 mm 0.433 in
Tool (for flexible conductor without ferrule)		Flat screwdriver Ø 3.5 mm Ø 0.138 in

Explosive atmosphere classification

IM2 II 2 GD Ex eb I/IC/IIIC
The connecting capacity data for one Rigid: Solid/Stranded, or one Flexible conductor (when applicable) is a mandatory information required by IEC, UL and CSA standards (Copper conductors). All other data are provided as supplementary information only. For more details, please consult our CB, UL or CSA certificates and technical datasheet available on <http://www.TE.com>



Accessories

Description	Color	Type	Part Number	Pkg qty	Weight (1 pce) g
1 End stops 10 mm 0.394 in	Dark grey	BAZH1	1SNK900102R0000	20	24.00
2 End sections 0.8 mm 0.031 in	Dark grey	EK2.5-T3	1SNK705961R0000	20	4.76
3 Test adapters For test plugs DIA 2 mm 0.079 in For test plugs DIA 4 mm 0.157 in	Dark grey	TP2	1SNK900203R0000	20	1.70
		TP4	1SNK900205R0000	20	2.40
4 Test connectors 5.2 mm 0.205 in spacing End module, 5.2 mm 0.205 in	Dark grey	TC5	1SNK900200R0000	10	5.20
		TC5-R1	1SNK900201R0000	10	5.20
5 Label holders	Dark grey	LH-J	1SNK900606R0000	100	0.73
6 Terminal block markers Blank marker Blank card Universal wire markers holder	White	MG-CPM 13 41790	1SNB041790R0512	1960	0.23
		MC512	1SNK140000R0000	22	9.00
		MC512PA	1SNK149999R0000	20	10.00
		UMH	1SNK900611R0000	10	0.20

Complete list of accessories is indicated in the terminal block datasheet including end stops.

Some accessories such as jumper bars may modify the terminal block's ratings: Complete information available in the accessories section of the catalog.

Technical data valid for copper conductors only.

ZK2.5-CH-4P-LR PI-Spring terminal blocks

Component holder - 5.2 mm 0.205 in spacing



Description

- Protect your circuit with one 1N4007 diode,
- Clear identification of the diode orientation with marking identification on the top of the terminal block

Ordering details

Description	Color	Type	Part Number	Pkg qty	Weight (1 pce)
Component holder with 1 test socket DIA 2 mm 0.079 in	Grey <input type="checkbox"/>	ZK2.5-CH-4P-LR	1SNK705710R0000	50	10.91

Main technical data

Connecting capacity	IEC	UL - CSA	Rail	Wire stripping length	TH 35-7.5, TH 35-15
1 conductor per clamp	Rigid: Solid/Stranded	0.2 ... 4 mm ²	26 ... 12 AWG	11 mm 0.433 in	Flat screwdriver Ø 3.5 mm Ø 0.138 in
	Flexible without ferrule	0.22 ... 2.5 mm ²	26 ... 14 AWG		
	Flexible with non insulated ferrule	0.22 ... 2.5 mm ²	26 ... 14 AWG		
	Flexible with insulated ferrule	0.22 ... 2.5 mm ²	26 ... 14 AWG		
2 conductors per clamp	Flexible with twin ferrule	0.22 ... 0.5 mm ²	26 ... 20 AWG	Tool (for flexible conductor without ferrule)	
Rated current / Rated cross section		1 A / 2.5 mm ²	1 A / 12 AWG		
Rated short-time withstand current (1s)					
Short Circuit Current Rating (with specific conditions)					
Rated voltage		630 V	300 V		
Impulse withstand voltage					
Protection		IP20	NEMA 1		

Mounting instructions

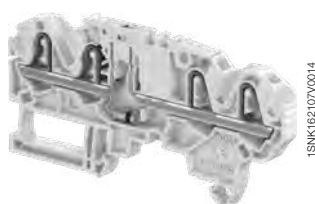

ZK2.5-CH-4P

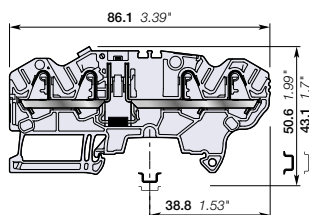

5.2 mm 0.205 in spacing

The connecting capacity data for one Rigid: Solid/Stranded, or one Flexible conductor (when applicable) is a mandatory information required by IEC, UL and CSA standards (Copper conductors). All other data are provided as supplementary information only. For more details, please consult our CB, UL or CSA certificates and technical datasheet available on <http://www.TE.com>

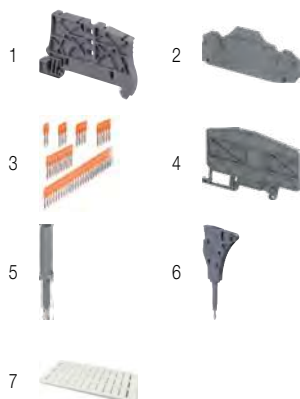

Accessories

Description	Color	Type	Part Number	Pkg qty	Weight (1 pce)	
1 End stops	Dark grey <input type="checkbox"/>	BAZ1	1SNK900002R0000	50	5.30	
2 End sections	Dark grey <input type="checkbox"/>	EK2.5-S-4P	1SNK705913R0000	20	2.94	
3 Jumper bars	Orange <input type="checkbox"/>	2 poles	JB5-2	1SNK905302R0000	50	1.30
		3 poles	JB5-3	1SNK905303R0000	50	2.00
		4 poles	JB5-4	1SNK905304R0000	50	2.70
		5 poles	JB5-5	1SNK905305R0000	50	3.50
		10 poles	JB5-10	1SNK905310R0000	30	7.10
50 poles	JB5-50	1SNK905350R0000	10	36.00		
4 Circuit separators	Dark grey <input type="checkbox"/>	CS-R3	1SNK900107R0000	20	6.40	
5 Test adapters	Dark grey <input type="checkbox"/>	For test plugs DIA 2 mm 0.079 in	TP2	1SNK900203R0000	20	1.70
		For test plugs DIA 4 mm 0.157 in	TP4	1SNK900205R0000	20	2.40
6 Test connectors	Dark grey <input type="checkbox"/>	5.2 mm 0.205 in spacing	TC5	1SNK900200R0000	10	5.20
		End module, 5.2 mm 0.205 in	TC5-R1	1SNK900201R0000	10	5.20
7 Terminal block markers	White <input type="checkbox"/>	Blank marker	MG-CPM 13 41790	1SNK041790R0512	1960	0.23
		Blank card	MC512	1SNK140000R0000	22	9.00
			MC512PA	1SNK149999R0000	20	10.00
		Universal wire markers holder	Grey <input type="checkbox"/>	UMH	1SNK900611R0000	10

Complete list of accessories is indicated in the terminal block datasheet including end stops. Some accessories such as jumper bars may modify the terminal block's ratings: Complete information available in the accessories section of the catalog.

Technical data valid for copper conductors only.

ZK2.5-CH-4P-RL PI-Spring terminal blocks

Component holder - 5.2 mm 0.205 in spacing

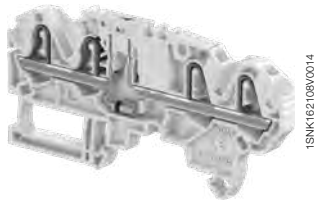

ZK2.5-CH-4P

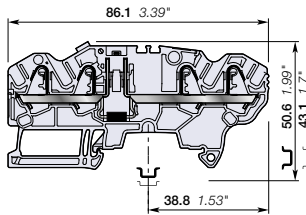

5.2 mm 0.205 in spacing

Description

- Protect your circuit with one 1N4007 diode,
- Clear identification of the diode orientation with marking identification on the top of the terminal block

Ordering details

Description	Color	Type	Part Number	Pkg qty	Weight (1 pce) g
Component holder with 1 test socket DIA 2 mm 0.079 in	Grey <input type="checkbox"/>	ZK2.5-CH-4P-RL	1SNK705711R0000	50	10.91

Main technical data

Connecting capacity	IEC	UL - CSA	Mounting instructions
1 conductor per clamp	Rigid: Solid/Stranded Flexible without ferrule Flexible with non insulated ferrule Flexible with insulated ferrule	0.2 ... 4 mm ² 0.22 ... 2.5 mm ² 0.22 ... 2.5 mm ² 0.22 ... 2.5 mm ²	26 ... 12 AWG 26 ... 14 AWG 26 ... 14 AWG
2 conductors per clamp	Flexible with twin ferrule	0.22 ... 0.5 mm ²	26 ... 20 AWG
Rated current / Rated cross section		1 A / 2.5 mm ²	1 A / 12 AWG
Rated short-time withstand current (1s)			
Short Circuit Current Rating (with specific conditions)			
Rated voltage		630 V	300 V
Impulse withstand voltage			
Protection		IP20	NEMA 1

The connecting capacity data for one Rigid: Solid/Stranded, or one Flexible conductor (when applicable) is a mandatory information required by IEC, UL and CSA standards (Copper conductors). All other data are provided as supplementary information only. For more details, please consult our CB, UL or CSA certificates and technical datasheet available on <http://www.TE.com>

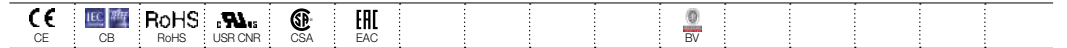

Accessories

Description	Color	Type	Part Number	Pkg qty	Weight (1 pce) g
1 End stops 5.2 mm 0.205 in	Dark grey <input type="checkbox"/>	BAZ1	1SNK900002R0000	50	5.30
2 End sections 2 mm 0.158 in	Dark grey <input type="checkbox"/>	EK2.5-S-4P	1SNK705913R0000	20	2.94
3 Jumper bars	Orange <input type="checkbox"/>	JB5-2	1SNK905302R0000	50	1.30
2 poles 32 A (IEC)		JB5-3	1SNK905303R0000	50	2.00
3 poles 32 A (IEC)		JB5-4	1SNK905304R0000	50	2.70
4 poles 32 A (IEC)		JB5-5	1SNK905305R0000	50	3.50
5 poles 32 A (IEC)		JB5-10	1SNK905310R0000	30	7.10
10 poles 32 A (IEC)		JB5-50	1SNK905350R0000	10	36.00
50 poles 32 A (IEC)					
4 Circuit separators 3 mm 0.118 in	Dark grey <input type="checkbox"/>	CS-R3	1SNK900107R0000	20	6.40
5 Test adapters	Dark grey <input type="checkbox"/>	TP2	1SNK900203R0000	20	1.70
For test plugs DIA 2 mm 0.079 in		TP4	1SNK900205R0000	20	2.40
For test plugs DIA 4 mm 0.157 in					
6 Test connectors 5.2 mm 0.205 in spacing	Dark grey <input type="checkbox"/>	TC5	1SNK900200R0000	10	5.20
End module, 5.2 mm 0.205 in		TC5-R1	1SNK900201R0000	10	5.20
7 Terminal block markers	White <input type="checkbox"/>	MG-CPM 13 41790	1SNB041790R0512	1960	0.23
Blank marker		MC512	1SNK140000R0000	22	9.00
Blank card		MC512PA	1SNK149999R0000	20	10.00
Universal wire markers holder	Grey <input type="checkbox"/>	UMH	1SNK900611R0000	10	0.20

Complete list of accessories is indicated in the terminal block datasheet including end stops. Some accessories such as jumper bars may modify the terminal block's ratings: Complete information available in the accessories section of the catalog.

Technical data valid for copper conductors only.

ZK2.5-D-CH-UD PI-Spring terminal blocks

Component holder - 5.2 mm 0.205 in spacing



ZK2.5-D-CH

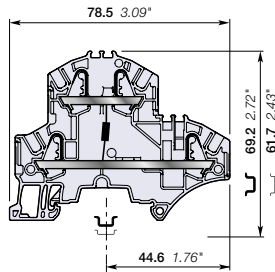

5.2 mm 0.205 in spacing

Description

Protect your circuit with one 1N4007 diode.

Ordering details

Description	Color	Type	Part Number	Pkg qty	Weight (1 pce) g
Component holder	Grey <input type="checkbox"/>	ZK2.5-D-CH-UD	1SNK705213R0000	50	11.20

Main technical data

Connecting capacity		IEC	UL - CSA	Mounting instructions	
1 conductor per clamp	Rigid: Solid/Stranded	0.2 ... 4 mm ²	26 ... 12 AWG	Rail	TH 35-7.5, TH 35-15
	Flexible without ferrule	0.22 ... 2.5 mm ²		Wire stripping length	11 mm 0.443 in
	Flexible with non insulated ferrule	0.22 ... 2.5 mm ²	26 ... 14 AWG	Tool (for flexible conductor without ferrule)	Flat screwdriver Ø 3.5 mm Ø 0.138 in
	Flexible with insulated ferrule	0.22 ... 2.5 mm ²	26 ... 14 AWG		
2 conductors per clamp	Flexible with twin ferrule	0.22 ... 0.5 mm ²	26 ... 20 AWG		
Rated current / Rated cross section		24 A / 2.5 mm ²	20 A / 12 AWG		
Rated short-time withstand current (1s)		300 A			
Short Circuit Current Rating (with specific conditions)					
Rated voltage		800 V	600 V		
Impulse withstand voltage					
Protection		IP20	NEMA 1		

The connecting capacity data for one Rigid: Solid/Stranded, or one Flexible conductor (when applicable) is a mandatory information required by IEC, UL and CSA standards (Copper conductors). All other data are provided as supplementary information only. For more details, please consult our CB, UL or CSA certificates and technical datasheet available on <http://www.TE.com>

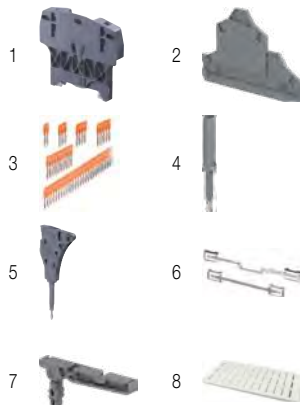
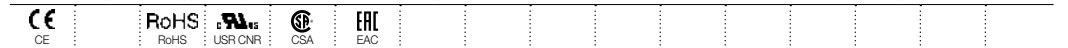

Accessories

Description	Color	Type	Part Number	Pkg qty	Weight (1 pce) g	
1 End stops	Dark grey <input type="checkbox"/>	BAZH1	1SNK900102R0000	20	24.00	
2 End sections	Dark grey <input type="checkbox"/>	EK2.5-D2	1SNK705960R0000	20	3.40	
3 Jumper bars	Orange <input type="checkbox"/>	2 poles	JB5-2	1SNK905302R0000	50	1.30
		3 poles	JB5-3	1SNK905303R0000	50	2.00
		4 poles	JB5-4	1SNK905304R0000	50	2.70
		5 poles	JB5-5	1SNK905305R0000	50	3.50
		10 poles	JB5-10	1SNK905310R0000	30	7.10
		50 poles	JB5-50	1SNK905350R0000	10	36.00
4 Test adapters	Dark grey <input type="checkbox"/>	For test plugs DIA 2 mm 0.079 in	TP2	1SNK900203R0000	20	1.70
		For test plugs DIA 4 mm 0.157 in	TP4	1SNK900205R0000	20	2.40
5 Test connectors	Dark grey <input type="checkbox"/>	5.2 mm 0.205 in spacing	TC5	1SNK900200R0000	10	5.20
		End module, 5.2 mm 0.205 in	TC5-R1	1SNK900201R0000	10	5.20
6 Shield connectors		SHB	1SNK900602R0000	20	4.90	
7 Label holders	Dark grey <input type="checkbox"/>	LH-J	1SNK900606R0000	100	0.73	
8 Terminal block markers	White <input type="checkbox"/>	Blank marker	MG-CPM 13 41790	1SNB041790R0512	1960	0.23
		Blank card	MC512	1SNK140000R0000	22	9.00
			MC512PA	1SNK149999R0000	20	10.00
	Universal wire markers holder	Grey <input type="checkbox"/>	UMH	1SNK900611R0000	10	0.20

Complete list of accessories is indicated in the terminal block datasheet including end stops. Some accessories such as jumper bars may modify the terminal block's ratings. Complete information available in the accessories section of the catalog.

Technical data valid for copper conductors only.

ZK2.5-D-CH-DU PI-Spring terminal blocks

Component holder - 5.2 mm 0.205 in spacing



Description

Protect your circuit with one 1N4007 diode.

Ordering details

Description	Color	Type	Part Number	Pkg qty	Weight (1 pce) g
Component holder	Grey <input type="checkbox"/>	ZK2.5-D-CH-DU	1SNK705214R0000	50	11.20

Main technical data

Connecting capacity		IEC	UL - CSA	Mounting instructions	
1 conductor per clamp	Rigid: Solid/Stranded	0.2 ... 4 mm ²	26 ... 12 AWG	Rail	TH 35-7.5, TH 35-15
	Flexible without ferrule	0.22 ... 2.5 mm ²		Wire stripping length	11 mm
	Flexible with non insulated ferrule	0.22 ... 2.5 mm ²	26 ... 14 AWG		0.443 in
	Flexible with insulated ferrule	0.22 ... 2.5 mm ²	26 ... 14 AWG		
2 conductors per clamp	Flexible with twin ferrule	0.22 ... 0.5 mm ²	26 ... 20 AWG	Tool (for flexible conductor without ferrule)	Flat screwdriver Ø 3.5 mm Ø 0.138 in
Rated current / Rated cross section		24 A / 2.5 mm ²	20 A / 12 AWG		
Rated short-time withstand current (1s)		300 A			
Short Circuit Current Rating (with specific conditions)					
Rated voltage		800 V	600 V		
Impulse withstand voltage					
Protection		IP20	NEMA 1		

The connecting capacity data for one Rigid: Solid/Stranded, or one Flexible conductor (when applicable) is a mandatory information required by IEC, UL and CSA standards (Copper conductors). All other data are provided as supplementary information only. For more details, please consult our CB, UL or CSA certificates and technical datasheet available on <http://www.TE.com>

CE	RoHS	UL	CSA	ERC	EAC
----	------	----	-----	-----	-----



1SNK162102X0014

ZK2.5-D-CH

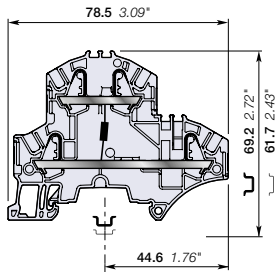

5.2 mm 0.205 in spacing

Accessories

Description	Color	Type	Part Number	Pkg qty	Weight (1 pce) g	
1 End stops	Dark grey <input checked="" type="checkbox"/>	BAZH1	1SNK900102R0000	20	24.00	
2 End sections	Dark grey <input checked="" type="checkbox"/>	EK2.5-D2	1SNK705960R0000	20	3.40	
3 Jumper bars	Orange <input checked="" type="checkbox"/>	2 poles 32 A (IEC)	JB5-2	1SNK905302R0000	50	1.30
		3 poles 32 A (IEC)	JB5-3	1SNK905303R0000	50	2.00
		4 poles 32 A (IEC)	JB5-4	1SNK905304R0000	50	2.70
		5 poles 32 A (IEC)	JB5-5	1SNK905305R0000	50	3.50
		10 poles 32 A (IEC)	JB5-10	1SNK905310R0000	30	7.10
4 Test adapters	Dark grey <input checked="" type="checkbox"/>	50 poles 32 A (IEC)	JB5-50	1SNK905350R0000	10	36.00
		For test plugs DIA 2 mm 0.079 in	TP2	1SNK900203R0000	20	1.70
		For test plugs DIA 4 mm 0.157 in	TP4	1SNK900205R0000	20	2.40
5 Test connectors	Dark grey <input checked="" type="checkbox"/>	5.2 mm 0.205 in spacing	TC5	1SNK900200R0000	10	5.20
		End module, 5.2 mm 0.205 in	TC5-R1	1SNK900201R0000	10	5.20
6 Shield connectors		SHB	1SNK900602R0000	20	4.90	
7 Label holders	Dark grey <input checked="" type="checkbox"/>	LH-J	1SNK900606R0000	100	0.73	
8 Terminal block markers	White <input type="checkbox"/>	Blank marker	MG-CPM 13 41790	1SNB041790R0512	1960	0.23
		Blank card	MC512	1SNK140000R0000	22	9.00
			MC512PA	1SNK149999R0000	20	10.00
	Universal wire markers holder	Grey <input type="checkbox"/>	UMH	1SNK900611R0000	10	0.20

Complete list of accessories is indicated in the terminal block datasheet including end stops. Some accessories such as jumper bars may modify the terminal block's ratings: Complete information available in the accessories section of the catalog.

Technical data valid for copper conductors only.

ZK2.5-D-CH2-DU-RL PI-Spring terminal blocks

Component holder - 5.2 mm 0.205 in spacing



Description

- Protect your circuit with 1N4007 diodes;
- Convenient identification of the diodes orientation on the terminal block front side.

Ordering details

Description	Color	Type	Part Number	Pkg qty	Weight (1 pce) g
Component holder	Grey <input type="checkbox"/>	ZK2.5-D-CH2-DU-RL	1SNK705219R0000	50	11.20

Main technical data

Connecting capacity		IEC	UL - CSA	Mounting instructions	
1 conductor per clamp	Rigid: Solid/Stranded	0.2 ... 4 mm ²	26 ... 12 AWG	Rail	TH 35-7.5, TH 35-15
	Flexible without ferrule	0.22 ... 2.5 mm ²	26 ... 14 AWG	Wire stripping length	11 mm 0.443 in
	Flexible with non insulated ferrule	0.22 ... 2.5 mm ²	26 ... 14 AWG		
	Flexible with insulated ferrule	0.22 ... 2.5 mm ²	26 ... 14 AWG		
2 conductors per clamp	Flexible with twin ferrule	0.22 ... 0.5 mm ²	26 ... 20 AWG	Tool (for flexible conductor without ferrule)	Flat screwdriver Ø 3.5 mm Ø 0.138 in
Rated current / Rated cross section		1 A / 2.5 mm ²	/ 12 AWG		
Rated short-time withstand current (1s)					
Short Circuit Current Rating (with specific conditions)					
Rated voltage		800 V	600 V		
Impulse withstand voltage					
Protection		IP20	NEMA 1		



ZK2.5-D-CH2

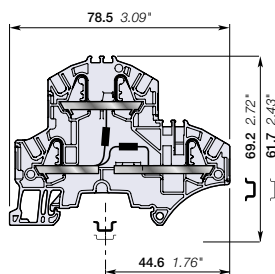

5.2 mm 0.205 in spacing

The connecting capacity data for one Rigid: Solid/Stranded, or one Flexible conductor (when applicable) is a mandatory information required by IEC, UL and CSA standards (Copper conductors). All other data are provided as supplementary information only. For more details, please consult our CB, UL or CSA certificates and technical datasheet available on <http://www.TE.com>

--	--	--	--	--	--	--	--	--	--

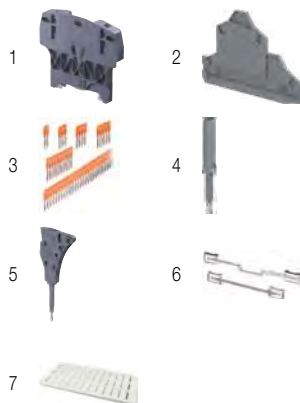

Accessories

Description	Color	Type	Part Number	Pkg qty	Weight (1 pce) g	
1 End stops	Dark grey <input type="checkbox"/>	BAZH1	1SNK900102R0000	20	24.00	
2 End sections	Dark grey <input type="checkbox"/>	EK2.5-D2	1SNK705960R0000	20	3.40	
3 Jumper bars	Orange <input type="checkbox"/>	2 poles	JB5-2	1SNK905302R0000	50	1.30
		3 poles	JB5-3	1SNK905303R0000	50	2.00
		4 poles	JB5-4	1SNK905304R0000	50	2.70
		5 poles	JB5-5	1SNK905305R0000	50	3.50
		10 poles	JB5-10	1SNK905310R0000	30	7.10
		50 poles	JB5-50	1SNK905350R0000	10	36.00
4 Test adapters	Dark grey <input type="checkbox"/>	For test plugs DIA 2 mm 0.079 in	TP2	1SNK900203R0000	20	1.70
		For test plugs DIA 4 mm 0.157 in	TP4	1SNK900205R0000	20	2.40
5 Test connectors	Dark grey <input type="checkbox"/>	5.2 mm 0.205 in spacing	TC5	1SNK900200R0000	10	5.20
		End module, 5.2 mm 0.205 in	TC5-R1	1SNK900201R0000	10	5.20
			SHB	1SNK900602R0000	20	4.90
6 Shield connectors	White <input type="checkbox"/>	Blank marker	MG-CPM 13 41790	1SNB041790R0512	1960	0.23
		Blank card	MC512	1SNK140000R0000	22	9.00
			MC512PA	1SNK149999R0000	20	10.00
		Universal wire markers holder	Grey <input type="checkbox"/>	UMH	1SNK900611R0000	10

Complete list of accessories is indicated in the terminal block datasheet including end stops. Some accessories such as jumper bars may modify the terminal block's ratings: Complete information available in the accessories section of the catalog.

Technical data valid for copper conductors only.

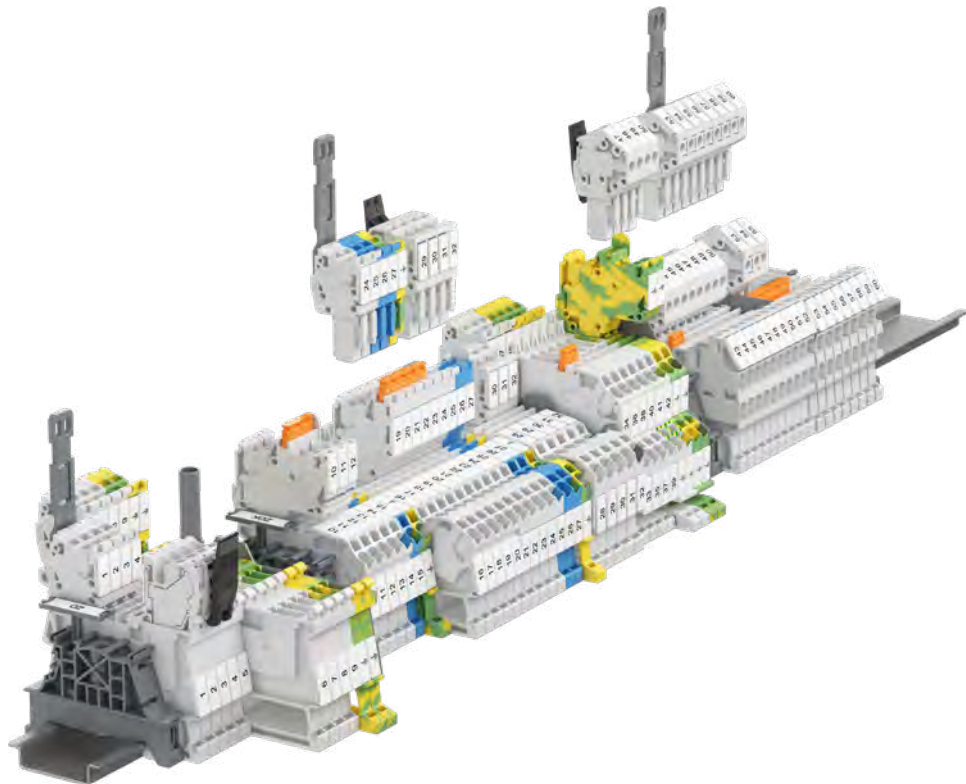

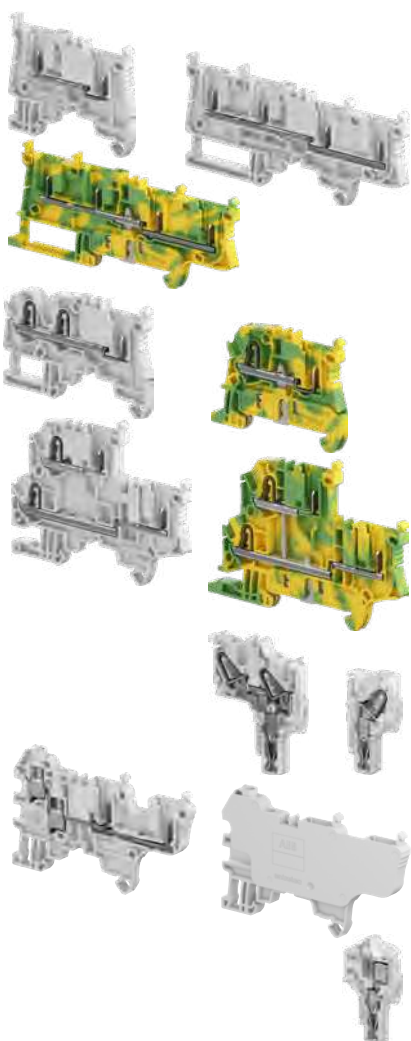

Technologies presentation			70
Overview			76
PI-Spring Pluggable			
Pluggable Pluggable			
2.5 mm ² / 12 AWG	Feed-through	ZD2.5-11	80
		ZD2.5-22	81
	Ground	ZD2.5-22-PE	82
PI-Spring Pluggable			
2.5 mm ² / 12 AWG	Feed-through	ZDK2.5-11	83
		ZDK2.5-21	84
		ZDK2.5-22	85
4 mm ² / 10 AWG	Feed-through	ZDK4-22	86
2.5 mm ² / 12 AWG	Ground	ZDK2.5-11-PE	87
		ZDK2.5-22-PE	88
	Double deck	ZDK2.5-D2	89
		ZDK2.5-D1	90
		ZDK2.5-D2-PE	91
		ZDK2.5-D1-PE	92
PI-Spring female plugs		CDK2.5	93
		CDK2.5-J	94
		CDK2.5-2P-J	95
		CDK4	96
Screw clamp Pluggable			
4 mm ² / 10 AWG	Feed-through	ZDS4-22	98
		ZDS4-22-R1	100
Screw clamp female plugs		CDS4	99
		CDS4-R1	101

Pluggable technology - SNK series, terminal blocks

Features and benefits

The SNK series pluggable terminal blocks combine the benefits of our smart connections with the flexibility of the pluggable function.

PI-Spring Pluggable



PI-Spring Pluggable



Pluggable Pluggable

Screw clamp Pluggable



Speed up your projects

Modularity brings assembly flexibility

Pluggable technology brings modularity into the electrical installation allowing the combination of sub-assemblies and prewired harnesses that facilitate and considerably accelerate assembly test and factory commissioning.

Better project identification

- Circuit identification is improved thanks to the 20% larger marking area
- Pre-mark by hand or with label on our flat marking surface and start immediately the wiring, before the final markers mounting
- Spare markers re-printing in case of modifications.



Clear circuit identification

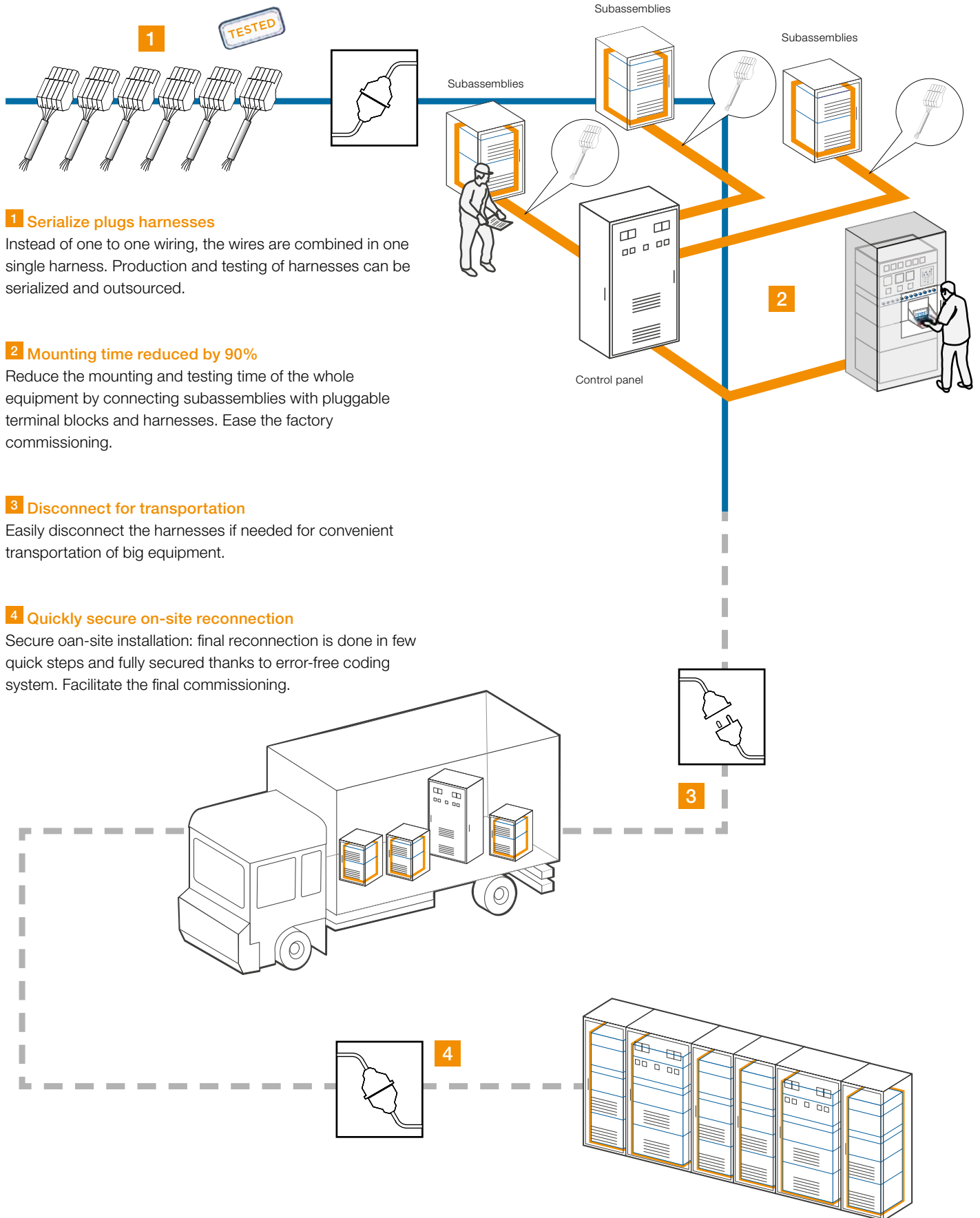

1 Serialize plugs harnesses

Instead of one to one wiring, the wires are combined in one single harness. Production and testing of harnesses can be serialized and outsourced.

2 Mounting time reduced by 90%

Reduce the mounting and testing time of the whole equipment by connecting subassemblies with pluggable terminal blocks and harnesses. Ease the factory commissioning.

3 Disconnect for transportation

Easily disconnect the harnesses if needed for convenient transportation of big equipment.

4 Quickly secure on-site reconnection

Secure on-site installation: final reconnection is done in few quick steps and fully secured thanks to error-free coding system. Facilitate the final commissioning.

3

4

Pluggable technology - SNK series, terminal blocks

Features and benefits

Easy to install

Smart design facilitating assembly process

Mounting, wiring, testing... made easy.

Create your own assemblies without tooling:

- Easily snap together multiple plugs
- Eliminate stock of pre-configured plugs.

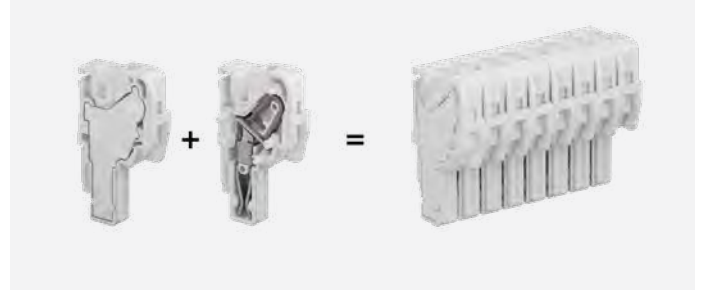

Only two plug variants are required to compose harnesses up to 15 poles

Some plugs feature a jumper channel and/or 2 connections that ease the signal distribution or wiring daisy chaining of subassemblies.



Easy signal distribution on plugs

Safety and protection

Eliminate connection errors with coding pegs:

- Simply insert the pegs to create a coding sequence.

Secure your wiring against accidental tearing:

- Automatic locking function
- Lock safely 2 to 8 plugs with only one locking device
- Cable clamp secures the wires onto the plug when pulling the plug assembly.



Convenient coding pegs

Cable clamp & locking device

SNK series, terminal blocks

Features and benefits

Faster accessories mounting

Save up to 70% mounting time thanks to:

- Screwless jumpers, component plugs, test devices, end stops and snap-in ground terminal blocks.

Closed jumper location allows great stiffness of the terminal block, avoid deflection while tightening and optimal jumper guiding.

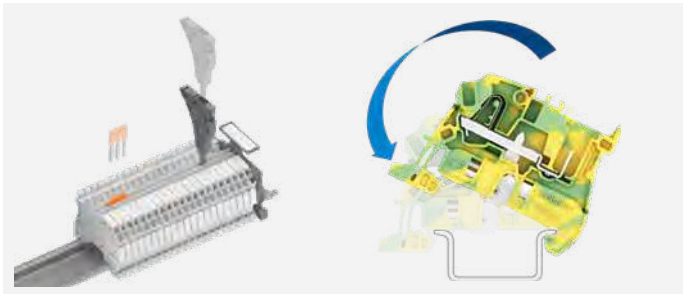

Screwless accessories

Snap-in ground terminal blocks

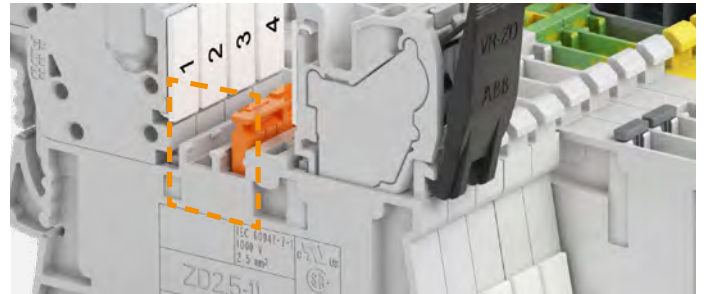

Closed jumper location for stiffness

Smart accessories

Flexible test solutions from individual insulated test adapter to test connectors for complete assemblies testing.

- Direct plug-in into jumpers channels
- 5, 6, 8 mm spacing, mixing various spacing is possible
- 1000 V rating.

Smart plug-in jumpers

Pre-cut poles removable by hand: clean cut.

Insulated up to 1000 V (avoid use of separators).

Predefined shapes in molding to easily identify connected poles with a pen.



Plug-in individual test adapter

Plug-in test connector

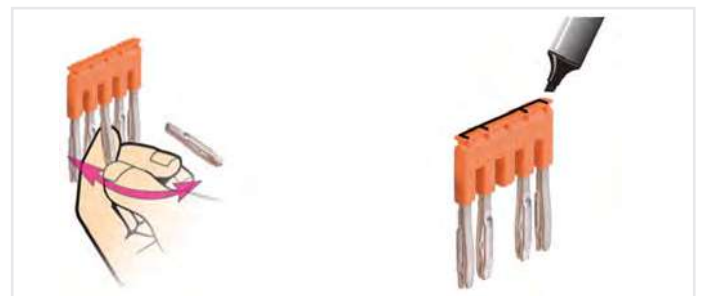

Pre-cut poles easy removable by hand

Predefined shape to identify connected poles

Pluggable technology - SNK series, terminal blocks

Features and benefits

Optimized logistics

Reduce your accessories inventory by up to 50%

SNK PI-Spring, screw and pluggable ranges share the same accessories.

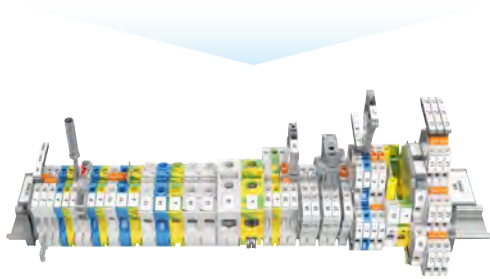

Shared accessories for SNK PI-Spring, screw and pluggable ranges

Facilitate maintenance operations

Terminal blocks can be individually removed from a terminal assembly equipped with markers: TE Connectivity markers become independent after strip mounting. The markers remain on terminal in any situation.

Markers are interchangeable: the smaller marker can fit any bigger block.



Maintenance operations facilitated

Reliable in harsh conditions

Qualified for worldwide markets, applications and for severe environments: vibration, shock, corrosion...



SNK series, terminal blocks

Pluggable technology - Range overview from 2.5 to 4 mm² - 12 to 10 AWG

PI-Spring pluggable

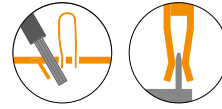

Pluggable pluggable

2

Connections
Single deck
Feed-through

4

Connections
Single deck
Feed-through
Ground

2

Connections
Single deck
Feed-through
Ground

3

Connections
Single deck
Feed-through

4

Connections
Single deck
Feed-through
Ground

Plugs

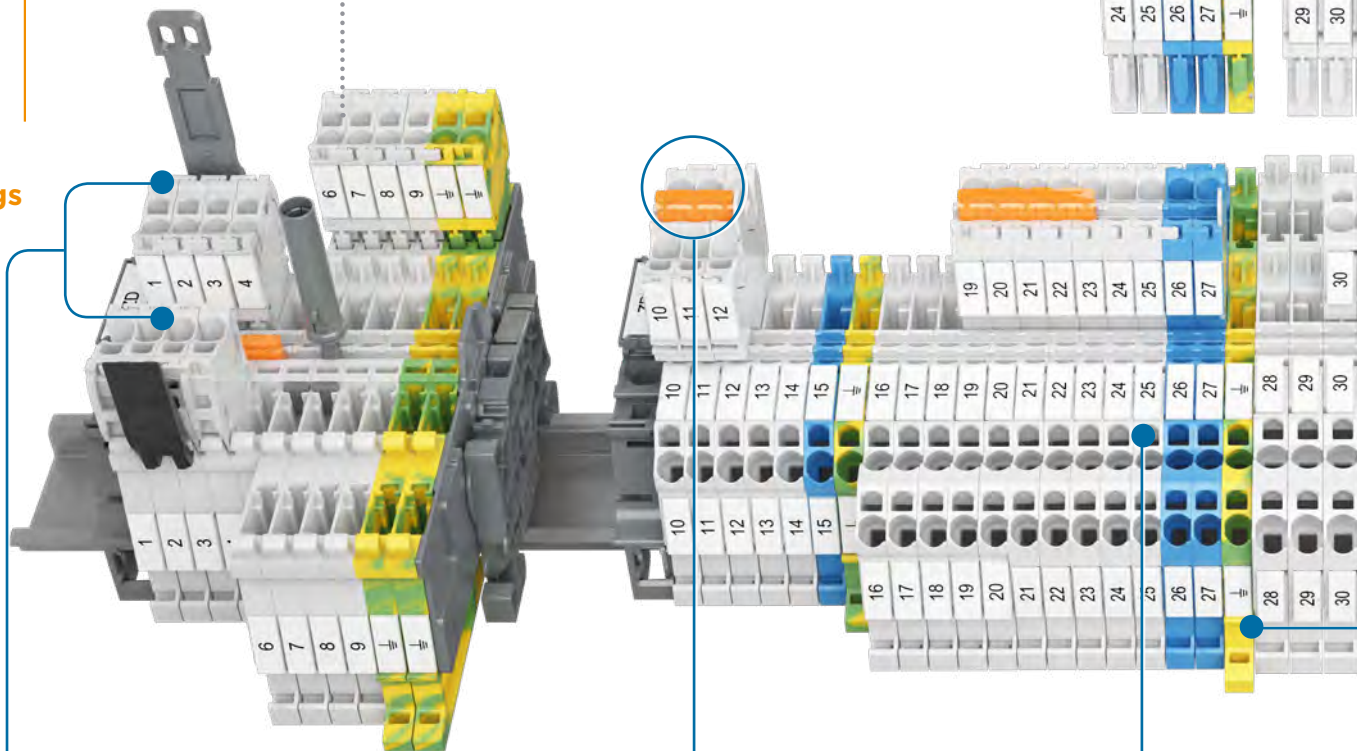

Compact plug

Save up to 15%
in height

Reduced plug variants

Only two plugs variants
to create assemblies

Jumper plugs

Plugs with 1 or 2 connection
& jumper to ease potential
distribution

Voltage test

Screwdriver entry point
accepts category II probes

2x2

Connections
Double deck
Feed-through
Ground

Screw clamp pluggable

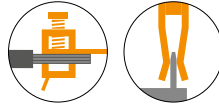

4

Connections
Single deck
Feed-through

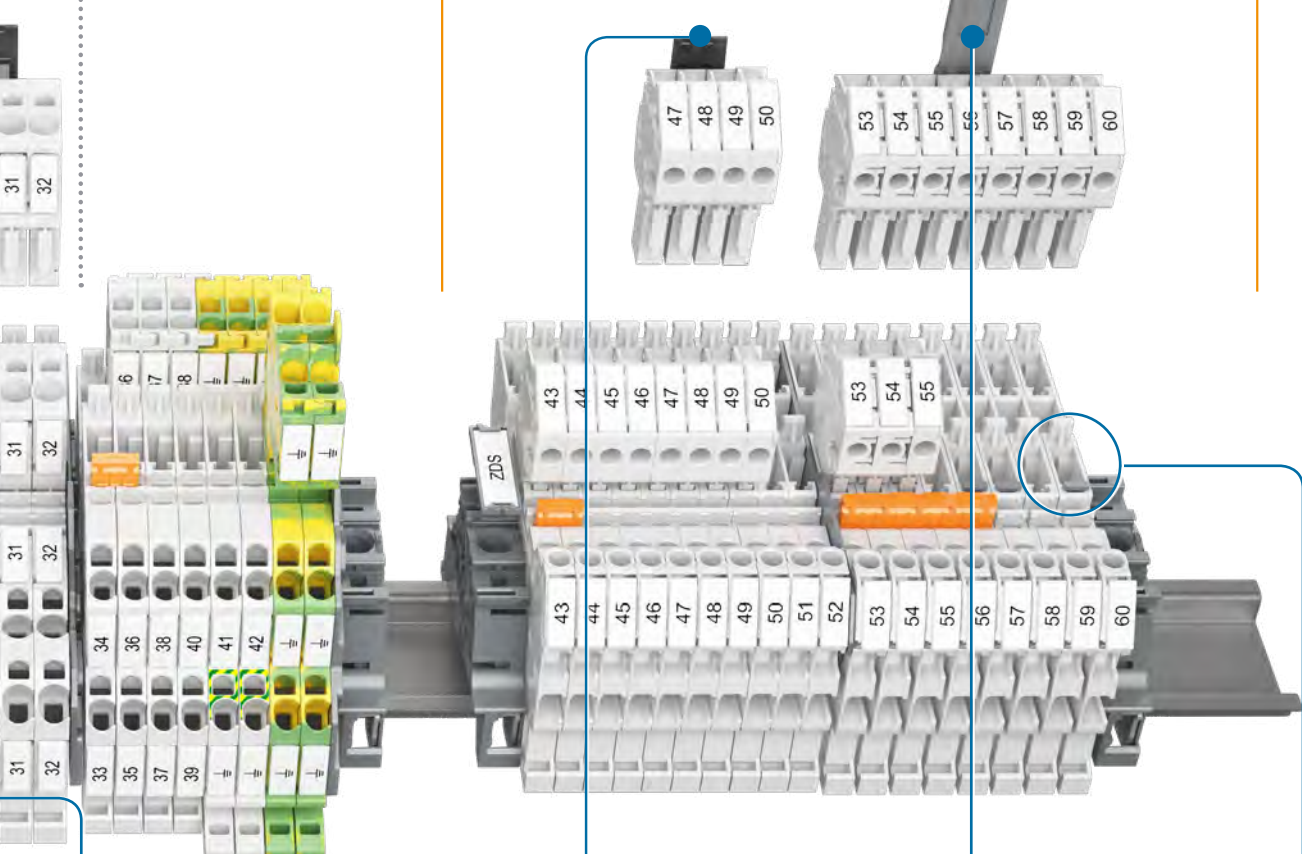

End section

No need of end section between 2.5 and 4 mm² terminal blocks



Locking device

Secure plug and wiring against accidental pulling

Cable clamp

Secure the wires onto the plug when pulling the plug assembly

Convenient coding pegs

Guarantee error free plugs insertion



SNK series, terminal blocks

Pluggable technology



PI-Spring Pluggable

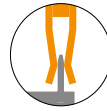

Single deck



Section		Feed-through		Ground	Feed-through		Ground	
2.5 mm ²	12 AWG	ZD2.5-11	ZD2.5-22	ZD2.5-22-PE	ZDK2.5-11	ZDK2.5-21	ZDK2.5-22	ZDK2.5-11-PE
4 mm ²	10 AWG					ZDK4-22		ZDK2.5-22-PE

Double deck

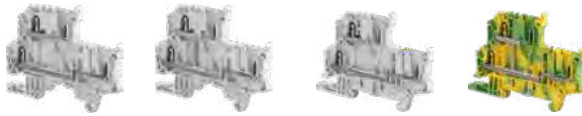

Section		Feed-through	Feed-through + ground	Ground
2.5 mm ²	12 AWG	ZDK2.5-D2	ZDK2.5-D1	ZDK2.5-D2-PE
4 mm ²	10 AWG			ZDK2.5-D1-PE

PI-Spring female plugs



Section		Closed		Closed		Closed		Closed		Closed		Closed	
2.5 mm ²	12 AWG	CDK2.5	CDK2.5-E	CDK2.5-J	CDK2.5-J-E	CDK2.5-2P-J	CDK2.5-2P-J-E	CDK2.5-PE	CDK2.5-PE-E	CDK2.5-J-PE	CDK2.5-J-PE-E	CDK2.5-2P-J-PE	CDK2.5-2P-J-PE
4 mm ²	10 AWG	CDK4	CDK4-E										



Screw clamp Pluggable

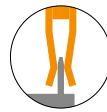

Single deck

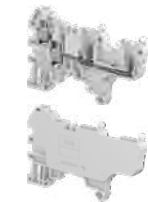

Section		Feed-through
4 mm ²	10 AWG	ZDS4-22 ZDS4-22-R1

Screw clamp female plugs



Section		Closed	
4 mm ²	10 AWG	CDS4 CDS4-R1	CDS4-E

◦ clamp -
 v Channels for jumpering or testing -
 Y test socket -
 ⊗ Blown-fuse indicator -
 ♂ male pluggable clamp -
 ♀ female pluggable clamp

PI-Spring Pluggable

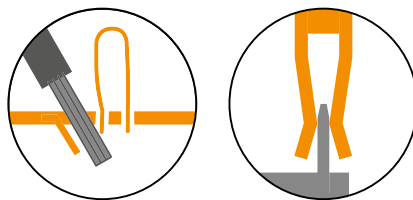

ZD2.5-11 PI-Spring pluggable terminal blocks

Feed-through - 5.2 mm 0.205 in spacing



ZD2.5-11

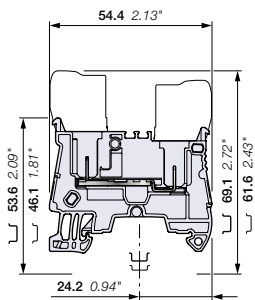

5.2 mm 0.205 in spacing

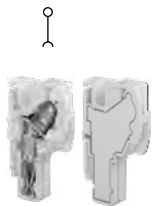

CDK2.5 CDK2.5-E



Description

- Increase your productivity with pluggable terminal blocks: possibility of pre-produced plugs harnesses, time saving plug and play assembly, reduced transportation panels preparation and final installation, easily connect sub-assemblies together,
- Simplify and secure your installation: in site faulty connection errors are eliminated, prior connection testing is eased and reliable, test connectors (TC5) withstanding 10 000 operations are compatible for convenient testing.

Ordering details

Description	Color	Type	Part Number	Pkg qty	Weight (1 pce) g
Feed-through 2 connections	Grey	ZD2.5-11	1SNK805016R0000	50	5.66

Main technical data

Connecting capacity	IEC	UL - CSA	Mounting instructions
1 conductor per clamp	Rigid: Solid/Stranded	0.2 ... 4 mm ²	26 ... 12 AWG
	Flexible without ferrule	0.22 ... 2.5 mm ²	26 ... 14 AWG
	Flexible with non insulated ferrule	0.22 ... 2.5 mm ²	26 ... 14 AWG
	Flexible with insulated ferrule	0.22 ... 2.5 mm ²	26 ... 14 AWG
2 conductors per clamp	Flexible with twin ferrule	0.22 ... 0.5 mm ²	26 ... 20 AWG
	Rated current / Rated cross section	22 A / 2.5 mm ²	20 A / 12 AWG
Rated short-time withstand current (1s)	300 A		
Rated voltage	1000 V	600 V	
Impulse withstand voltage	8000 V		
Protection	IP20	NEMA 1	

The connecting capacity data for one Rigid: Solid/Stranded, or one Flexible conductor (when applicable) is a mandatory information required by IEC, UL and CSA standards (Copper conductors). All other data are provided as supplementary information only. For more details, please consult our CB, UL or CSA certificates and technical datasheet available on <http://www.TE.com>

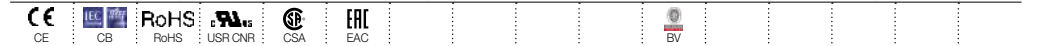

Female plugs

Description	Color	Type	Part Number	Pkg qty	Weight (1 pce) g
Female plugs 1 pole	Grey	CDK2.5	1SNK805712R0000	50	2.80
Female plugs without outer nubs - Closed 15 poles max.		CDK2.5-E	1SNK805713R0000	50	2.88

Accessories

Description	Color	Type	Part Number	Pkg qty	Weight (1 pce) g	
1 End stops 5.2 mm 0.205 in	Dark grey	BAZ1	1SNK900002R0000	50	5.30	
2 End sections 1.5 mm 0.059 in	Dark grey	EDK2.5-11	1SNK805915R0000	20	1.49	
3 Jumper bars 2 poles 32 A (IEC)	Orange	JB5-2	1SNK905302R0000	50	1.30	
		3 poles 32 A (IEC)	JB5-3	1SNK905303R0000	50	2.00
		4 poles 32 A (IEC)	JB5-4	1SNK905304R0000	50	2.70
		5 poles 32 A (IEC)	JB5-5	1SNK905305R0000	50	3.50
		10 poles 32 A (IEC)	JB5-10	1SNK905310R0000	30	7.10
		50 poles 32 A (IEC)	JB5-50	1SNK905350R0000	10	36.00
4 Cross spacing jumpers 3 poles 32 A (IEC)	Orange	JB85-3	1SNK900603R0000	10	2.80	
5 Circuit separators 3 mm 0.118 in	Dark grey	CS-R2	1SNK900106R0000	20	3.80	
6 Test adapters For test plugs DIA 2 mm 0.079 in	Dark grey	TP2	1SNK900203R0000	20	1.70	
		For test plugs DIA 4 mm 0.157 in	TP4	1SNK900205R0000	20	2.40
7 Test connectors 5.2 mm 0.205 in spacing	Dark grey	TC5	1SNK900200R0000	10	5.20	
		End module, 5.2 mm 0.205 in	TC5-R1	1SNK900201R0000	10	5.20
			COP-ZD	1SNK900636R0000	10	3.57
8 Coding pegs	Dark grey					
9 Terminal block markers	White	MC512	1SNK140000R0000	22	9.00	
		MC512PA	1SNK149999R0000	20	10.00	
		Blank marker	MG-CPM 13 41790	1SNB041790R0512	1960	0.236
		Universal wire markers holder	UMH	1SNK900611R0000	10	0.20

Complete list of accessories is indicated in the terminal block datasheet including end stops.

Some accessories such as jumper bars may modify the terminal block's ratings: Complete information available in the accessories section of the catalog.

Technical data valid for copper conductors only.

ZD2.5-22 PI-Spring pluggable terminal blocks

Feed-through - 5.2 mm 0.205 in spacing

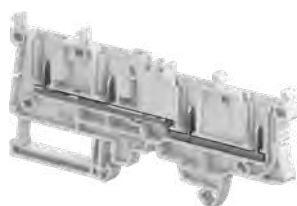

1SNK805017R0000

ZD2.5-22

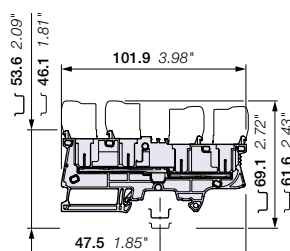

5.2 mm 0.205 in spacing

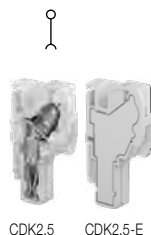

CDK2.5 CDK2.5-E



Description

- Increase your productivity with pluggable terminal blocks: possibility of pre-produced plugs harnesses, time saving plug and play assembly, reduced transportation panels preparation and final installation, easily connect sub-assemblies together,
- Simplify and secure your installation: in site faulty connection errors are eliminated, prior connection testing is eased and reliable, test connectors (TC5) withstanding 10 000 operations are compatible for convenient testing.

Ordering details

Description	Color	Type	Part Number	Pkg qty	Weight (1 pce) g
Feed-through 4 connections	Grey <input type="checkbox"/>	ZD2.5-22	1SNK805017R0000	50	12.00

Main technical data

Connecting capacity	IEC	UL - CSA	Rail	TH 35-7.5, TH 35-15
1 conductor per clamp	Rigid: Solid/Stranded	0.2 ... 4 mm ²	26 ... 12 AWG	11 mm 0.433 in
	Flexible without ferrule	0.22 ... 2.5 mm ²		
	Flexible with non insulated ferrule	0.22 ... 2.5 mm ²	26 ... 14 AWG	
	Flexible with insulated ferrule	0.22 ... 2.5 mm ²	26 ... 14 AWG	
2 conductors per clamp	Flexible with twin ferrule	0.22 ... 0.5 mm ²	26 ... 20 AWG	
Rated current / Rated cross section		22 A / 2.5 mm ²	20 A / 12 AWG	
Rated short-time withstand current (1s)		300 A		
Rated voltage		1000 V	600 V	
Impulse withstand voltage		8000 V		
Protection		IP20	NEMA 1	

Mounting instructions

Wire stripping length	Tool (for flexible conductor without ferrule)	Flat screwdriver
11 mm 0.433 in	Ø 3.5 mm Ø 0.138 in	

The connecting capacity data for one Rigid: Solid/Stranded, or one Flexible conductor (when applicable) is a mandatory information required by IEC, UL and CSA standards (Copper conductors). All other data are provided as supplementary information only. For more details, please consult our CB, UL or CSA certificates and technical datasheet available on <http://www.TE.com>

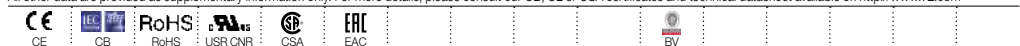

Female plugs

Description	Color	Type	Part Number	Pkg qty	Weight (1 pce) g
Female plugs 1 pole	Grey <input type="checkbox"/>	CDK2.5	1SNK805712R0000	50	2.80
Female plugs without outer nubs - Closed		CDK2.5-E	1SNK805713R0000	50	2.88

15 poles max.

Accessories

Description	Color	Type	Part Number	Pkg qty	Weight (1 pce) g	
1 End stops 5.2 mm 0.205 in	Dark grey <input type="checkbox"/>	BAZ1	1SNK900002R0000	50	5.30	
2 End sections 2.0 mm 0.079 in	Dark grey <input type="checkbox"/>	ED2.5-22	1SNK805917R0000	20	3.64	
3 Jumper bars 2 poles 32 A (IEC)	Orange <input type="checkbox"/>	JB5-2	1SNK905302R0000	50	1.30	
		3 poles 32 A (IEC)	JB5-3	1SNK905303R0000	50	2.00
		4 poles 32 A (IEC)	JB5-4	1SNK905304R0000	50	2.70
		5 poles 32 A (IEC)	JB5-5	1SNK905305R0000	50	3.50
		10 poles 32 A (IEC)	JB5-10	1SNK905310R0000	30	7.10
50 poles 32 A (IEC)		JB5-50	1SNK905350R0000	10	36.00	
4 Cross spacing jumpers 3 poles 32 A (IEC)	Orange <input type="checkbox"/>	JB85-3	1SNK900603R0000	10	2.80	
5 Circuit separators 3 mm 0.118 in	Dark grey <input type="checkbox"/>	CS-R3	1SNK900107R0000	20	6.40	
6 Test adapters For test plugs DIA 2 mm 0.079 in	Dark grey <input type="checkbox"/>	TP2	1SNK900203R0000	20	1.70	
		TP4	1SNK900205R0000	20	2.40	
7 Test connectors 5.2 mm 0.205 in spacing	Dark grey <input type="checkbox"/>	TC5	1SNK900200R0000	10	5.20	
		TC5-R1	1SNK900201R0000	10	5.20	
8 Coding pegs End module, 5.2 mm 0.205 in	Dark grey <input type="checkbox"/>	COP-ZD	1SNK900636R0000	10	3.57	
9 Terminal block markers	White <input type="checkbox"/>	MC512	1SNK140000R0000	22	9.00	
		MC512PA	1SNK149999R0000	20	10.00	
		MG-CPM 13 41790	1SNB041790R0512	1960	0.236	
		Universal wire markers holder	UMH	1SNK900611R0000	10	0.20

Complete list of accessories is indicated in the terminal block datasheet including end stops. Some accessories such as jumper bars may modify the terminal block's ratings: Complete information available in the accessories section of the catalog.

Technical data valid for copper conductors only.

1SNK16402150201

ZD2.5-22-PE PI-Spring pluggable terminal blocks

Ground - 5.2 mm 0.205 in spacing

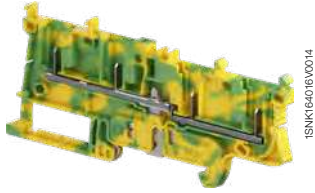

ZD2.5-22-PE

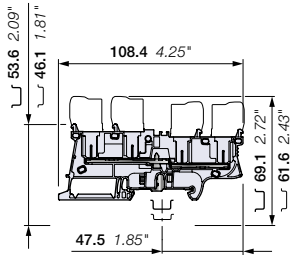

5.2 mm 0.205 in spacing

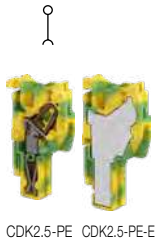

CDK2.5-PE CDK2.5-PE-E



Description

- Increase your productivity with pluggable terminal blocks: possibility of pre-produced plugs harnesses, time saving plug and play assembly, reduced transportation panels preparation and final installation, easily connect sub-assemblies together,
- Simplify and secure your installation: in site faulty connection errors are eliminated, prior connection testing is eased and reliable, test connectors (TC5) withstanding 10 000 operations are compatible for convenient testing.

Ordering details

Description	Color	Type	Part Number	Pkg qty	Weight (1 pce) g
Ground 4 connections	Green-yellow	ZD2.5-22-PE	1SNK805156R0000	50	14.80

Main technical data

Connecting capacity	IEC	UL - CSA	Mounting instructions		
1 conductor per clamp	Rigid: Solid/Stranded	0.2 ... 4 mm ²	26 ... 12 AWG	Rail	TH 35-7.5, TH 35-15
	Flexible without ferrule	0.22 ... 2.5 mm ²		Wire stripping length	11 mm 0.433 in
	Flexible with non insulated ferrule	0.22 ... 2.5 mm ²	26 ... 14 AWG		Tool (for flexible conductor without ferrule)
	Flexible with insulated ferrule	0.22 ... 2.5 mm ²	26 ... 14 AWG		
Rated cross section	2.5 mm ²	12 AWG			
Rated short-time withstand current (1s)	300 A	396 A			
Protection	IP20	NEMA 1			

The connecting capacity data for one Rigid: Solid/Stranded, or one Flexible conductor (when applicable) is a mandatory information required by IEC, UL and CSA standards (Copper conductors). All other data are provided as supplementary information only. For more details, please consult our CB, UL or CSA certificates and technical datasheet available on <http://www.TE.com>



Female plugs

Description	Color	Type	Part Number	Pkg qty	Weight (1 pce) g
Female plugs 1 pole	Green-yellow	CDK2.5-PE	1SNK805750R0000	50	2.80
Female plugs without outer nubs - Closed 15 poles max.		CDK2.5-PE-E	1SNK805753R0000	50	2.88

Accessories

Description	Color	Type	Part Number	Pkg qty	Weight (1 pce) g	
1 End stops 5.2 mm 0.205 in	Dark grey	BAZ1	1SNK900002R0000	50	5.30	
2 End sections 2.0 mm 0.079 in	Dark grey	ED2.5-22	1SNK805917R0000	20	3.64	
3 Circuit separators 3 mm 0.118 in	Dark grey	CS-R3	1SNK900107R0000	20	6.40	
4 Test adapters	Dark grey	For test plugs DIA 2 mm 0.079 in	TP2	1SNK900203R0000	20	1.70
		For test plugs DIA 4 mm 0.157 in	TP4	1SNK900205R0000	20	2.40
5 Test connectors 5.2 mm 0.205 in spacing	Dark grey	End module, 5.2 mm 0.205 in	TC5	1SNK900200R0000	10	5.20
			TC5-R1	1SNK900201R0000	10	5.20
6 Coding pegs	Dark grey	COP-ZD	1SNK900636R0000	10	3.57	
7 Terminal block markers	White	Blank card	MC512	1SNK140000R0000	22	9.00
			MC512PA	1SNK149999R0000	20	10.00
		Blank marker	MG-CPM 13 41790	1SNB041790R0512	1960	0.236
		Universal wire markers holder	Grey	UMH	1SNK900611R0000	10

Complete list of accessories is indicated in the terminal block datasheet including end stops. Some accessories such as jumper bars may modify the terminal block's ratings: Complete information available in the accessories section of the catalog.

Technical data valid for copper conductors only.

ZDK2.5-11 PI-Spring pluggable terminal blocks

Feed-through - 5.2 mm 0.205 in spacing



ZDK2.5-11

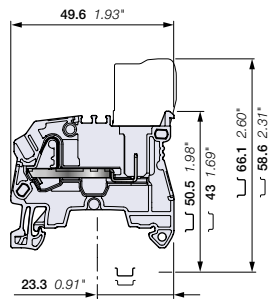

5.2 mm 0.205 in spacing

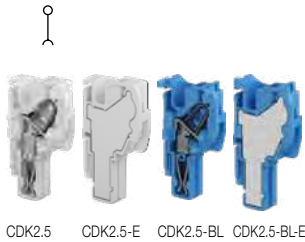

CDK2.5 CDK2.5-E CDK2.5-BL CDK2.5-BL-E



Description

- Increase your productivity with pluggable terminal blocks: possibility of pre-produced plugs harnesses, time saving plug and play assembly, reduced transportation panels preparation and final installation, easily connect sub-assemblies together,
- Simplify and secure your installation: in site faulty connection errors are eliminated, prior connection testing is eased and reliable, test connectors (TC5) withstanding 10 000 operations are compatible for convenient testing.

Ordering details

Description	Color	Type	Part Number	Pkg qty	Weight (1 pce) g
Feed-through 2 connections	Grey <input type="checkbox"/>	ZDK2.5-11	1SNK805015R0000	50	7.00
	Blue <input type="checkbox"/>	ZDK2.5-11-BL	1SNK805025R0000	50	7.00

Main technical data

Connecting capacity	IEC	UL - CSA	Mounting instructions
1 conductor per clamp	Rigid: Solid/Stranded	0.2 ... 4 mm ²	26 ... 12 AWG
	Flexible without ferrule	0.22 ... 2.5 mm ²	26 ... 14 AWG
	Flexible with non insulated ferrule	0.22 ... 2.5 mm ²	26 ... 14 AWG
	Flexible with insulated ferrule	0.22 ... 2.5 mm ²	26 ... 14 AWG
2 conductors per clamp	Flexible with twin ferrule	0.22 ... 0.5 mm ²	26 ... 20 AWG
Rated current / Rated cross section	24 A / 2.5 mm ²	20 A / 12 AWG	
Rated short-time withstand current (1s)	300 A		
Rated voltage	1000 V	600 V	
Impulse withstand voltage	8000 V		
Protection	IP20	NEMA 1	

The connecting capacity data for one Rigid: Solid/Stranded, or one Flexible conductor (when applicable) is a mandatory information required by IEC, UL and CSA standards (Copper conductors). All other data are provided as supplementary information only. For more details, please consult our CB, UL or CSA certificates and technical datasheet available on <http://www.TE.com>



Female plugs

Description	Color	Type	Part Number	Pkg qty	Weight (1 pce) g
Female plugs 1 pole	Grey <input type="checkbox"/>	CDK2.5	1SNK805712R0000	50	2.80
Female plugs without outer nubs - Closed		CDK2.5-E	1SNK805713R0000	50	2.88
Female plugs 1 pole	Blue <input type="checkbox"/>	CDK2.5-BL	1SNK805742R0000	50	2.80
Female plugs without outer nubs - Closed		CDK2.5-BL-E	1SNK805743R0000	50	2.88

15 poles max.

Accessories

Description	Color	Type	Part Number	Pkg qty	Weight (1 pce) g	
1 End stops 5.2 mm 0.205 in	Dark grey <input type="checkbox"/>	BAZ1	1SNK900002R0000	50	5.30	
2 End sections 1.5 mm 0.059 in	Dark grey <input type="checkbox"/>	EDK2.5-11	1SNK805915R0000	20	1.49	
3 Jumper bars	Orange <input type="checkbox"/>	2 poles 32 A (IEC)	JB5-2	1SNK905302R0000	50	1.30
		3 poles 32 A (IEC)	JB5-3	1SNK905303R0000	50	2.00
		4 poles 32 A (IEC)	JB5-4	1SNK905304R0000	50	2.70
		5 poles 32 A (IEC)	JB5-5	1SNK905305R0000	50	3.50
		10 poles 32 A (IEC)	JB5-10	1SNK905310R0000	30	7.10
		50 poles 32 A (IEC)	JB5-50	1SNK905350R0000	10	36.00
4 Cross spacing jumpers 3 poles 32 A (IEC)	Orange <input type="checkbox"/>	JB85-3	1SNK900603R0000	10	2.80	
5 Circuit separators 3 mm 0.118 in	Dark grey <input type="checkbox"/>	CS-R2	1SNK900106R0000	20	3.80	
6 Test adapters	Dark grey <input type="checkbox"/>	For test plugs DIA 2 mm 0.079 in	TP2	1SNK900203R0000	20	1.70
		For test plugs DIA 4 mm 0.157 in	TP4	1SNK900205R0000	20	2.40
7 Test connectors	Dark grey <input type="checkbox"/>	5.2 mm 0.205 in spacing	TC5	1SNK900200R0000	10	5.20
		End module, 5.2 mm 0.205 in	TC5-R1	1SNK900201R0000	10	5.20
8 Coding pegs	Dark grey <input type="checkbox"/>	COP-ZD	1SNK900636R0000	10	3.57	
9 Terminal block markers	White <input type="checkbox"/>	Blank card	MC512	1SNK140000R0000	22	9.00
		Blank marker	MG-CPM 13 41790	1SNB041790R0512	1960	0.236
		Universal wire markers holder	UMH	1SNK900611R0000	10	0.20

Complete list of accessories is indicated in the terminal block datasheet including end stops.

Some accessories such as jumper bars may modify the terminal block's ratings: Complete information available in the accessories section of the catalog.

Technical data valid for copper conductors only.

1SNK164-0235/0201

ZDK2.5-21 PI-Spring pluggable terminal blocks

Feed-through - 5.2 mm 0.205 in spacing

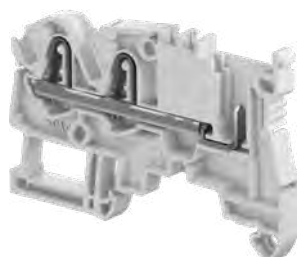

1SNK164020V0014

ZDK2.5-21

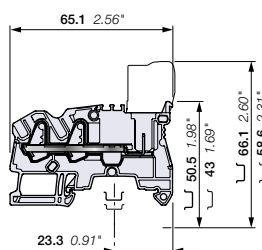

5.2 mm 0.205 in spacing

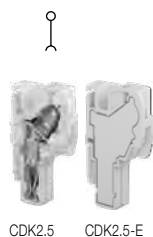

CDK2.5 CDK2.5-E



Description

- Increase your productivity with pluggable terminal blocks: possibility of pre-produced plugs harnesses, time saving plug and play assembly, reduced transportation panels preparation and final installation, easily connect sub-assemblies together,
- Simplify and secure your installation: in site faulty connection errors are eliminated, prior connection testing is eased and reliable, test connectors (TC5) withstanding 10 000 operations are compatible for convenient testing.

Ordering details

Description	Color	Type	Part Number	Pkg qty	Weight (1 pce) g
Feed-through 3 connections	Grey <input type="checkbox"/>	ZDK2.5-21	1SNK805014R0000	50	7.47

Main technical data

Connecting capacity	IEC	UL - CSA	Rail	TH 35-7.5, TH 35-15	
1 conductor per clamp	Rigid: Solid/Stranded	0.2 ... 4 mm ²	26 ... 12 AWG	Wire stripping length	11 mm 0.433 in
	Flexible without ferrule	0.22 ... 2.5 mm ²			
	Flexible with non insulated ferrule	0.22 ... 2.5 mm ²	26 ... 14 AWG		
	Flexible with insulated ferrule	0.22 ... 2.5 mm ²	26 ... 14 AWG		
2 conductors per clamp	Flexible with twin ferrule	0.22 ... 0.5 mm ²	26 ... 20 AWG	Tool (for flexible conductor without ferrule)	Flat screwdriver Ø 3.5 mm Ø 0.138 in
Rated current / Rated cross section		24 A / 2.5 mm ²	20 A / 12 AWG		
Rated short-time withstand current (1s)		300 A			
Rated voltage		1000 V	600 V		
Impulse withstand voltage		8000 V			
Protection		IP20	NEMA 1		

The connecting capacity data for one Rigid: Solid/Stranded, or one Flexible conductor (when applicable) is a mandatory information required by IEC, UL and CSA standards (Copper conductors). All other data are provided as supplementary information only. For more details, please consult our CB, UL or CSA certificates and technical datasheet available on <http://www.TE.com>

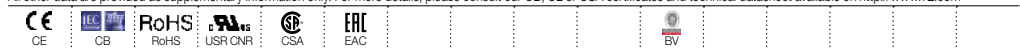

Mounting instructions

Female plugs

Description	Color	Type	Part Number	Pkg qty	Weight (1 pce) g
Female plugs 1 pole	Grey <input type="checkbox"/>	CDK2.5	1SNK805712R0000	50	2.80
Female plugs without outer nubs - Closed 15 poles max.		CDK2.5-E	1SNK805713R0000	50	2.88

Accessories

Description	Color	Type	Part Number	Pkg qty	Weight (1 pce) g	
1 End stops 5.2 mm 0.205 in	Dark grey <input type="checkbox"/>	BAZ1	1SNK900002R0000	50	5.30	
2 End sections 1.5 mm 0.059 in	Dark grey <input type="checkbox"/>	EDK2.5-21	1SNK805914R0000	20	1.90	
3 Jumper bars 2 poles 32 A (IEC)	Orange <input type="checkbox"/>	JB5-2	1SNK905302R0000	50	1.30	
		3 poles 32 A (IEC)	JB5-3	1SNK905303R0000	50	2.00
		4 poles 32 A (IEC)	JB5-4	1SNK905304R0000	50	2.70
		5 poles 32 A (IEC)	JB5-5	1SNK905305R0000	50	3.50
		10 poles 32 A (IEC)	JB5-10	1SNK905310R0000	30	7.10
		50 poles 32 A (IEC)	JB5-50	1SNK905350R0000	10	36.00
4 Cross spacing jumpers 3 poles 32 A (IEC)	Orange <input type="checkbox"/>	JB85-3	1SNK900603R0000	10	2.80	
5 Circuit separators 3 mm 0.118 in	Dark grey <input type="checkbox"/>	CS-R3	1SNK900107R0000	20	6.40	
6 Test adapters For test plugs DIA 2 mm 0.079 in	Dark grey <input type="checkbox"/>	TP2	1SNK900203R0000	20	1.70	
		TP4	1SNK900205R0000	20	2.40	
7 Test connectors 5.2 mm 0.205 in spacing	Dark grey <input type="checkbox"/>	TC5	1SNK900200R0000	10	5.20	
		TC5-R1	1SNK900201R0000	10	5.20	
8 Coding pegs End module, 5.2 mm 0.205 in	Dark grey <input type="checkbox"/>	COP-ZD	1SNK900636R0000	10	3.57	
9 Terminal block markers	White <input type="checkbox"/>	MC512	1SNK140000R0000	22	9.00	
		MC512PA	1SNK149999R0000	20	10.00	
		MG-CPM 13 41790	1SNB041790R0512	1960	0.236	
Universal wire markers holder	Grey <input type="checkbox"/>	UMH	1SNK900611R0000	10	0.20	

Complete list of accessories is indicated in the terminal block datasheet including end stops. Some accessories such as jumper bars may modify the terminal block's ratings: Complete information available in the accessories section of the catalog.

Technical data valid for copper conductors only.

ZDK2.5-22 PI-Spring pluggable terminal blocks

Feed-through - 5.2 mm 0.205 in spacing

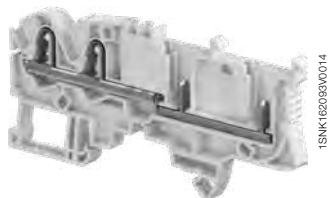

ZDK2.5-22

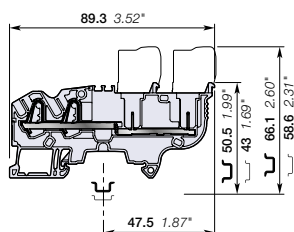

5.2 mm 0.205 in spacing

Description

- Increase your productivity with pluggable terminal blocks: possibility of pre-produced plugs harnesses, time saving plug and play assembly, reduced transportation panels preparation and final installation, easily connect sub-assemblies together,
- Simplify and secure your installation: in site faulty connection errors are eliminated, prior connection testing is eased and reliable, test connectors (TC5) withstanding 10 000 operations are compatible for convenient testing.

Ordering details

Description	Color	Type	Part number	Pkg qty	Weight (1 pce) g
Feed-through 4 connections	Grey <input type="checkbox"/>	ZDK2.5-22	1SNK805010R0000	50	9.60
Feed-through 4 connections	Blue <input type="checkbox"/>	ZDK2.5-22-BL	1SNK805020R0000	50	9.60

Main technical data

Connecting capacity	IEC	UL - CSA	Mounting instructions
1 conductor per clamp	Rigid: Solid/Stranded	0.2 ... 4 mm ²	26 ... 12 AWG
	Flexible without ferrule	0.22 ... 2.5 mm ²	26 ... 14 AWG
	Flexible with non insulated ferrule	0.22 ... 2.5 mm ²	26 ... 14 AWG
	Flexible with insulated ferrule	0.22 ... 2.5 mm ²	26 ... 14 AWG
2 conductors per clamp	Flexible with twin ferrule	0.22 ... 0.5 mm ²	26 ... 20 AWG
Rated current / Rated cross section		24 A / 2.5 mm ²	22 A / 12 AWG
Rated short-time withstand current (1s)		300 A	
Rated voltage		1000 V	600 V
Impulse withstand voltage		8000 V	
Protection		IP20	NEMA 1

The connecting capacity data for one Rigid: Solid/Stranded, or one Flexible conductor (when applicable) is a mandatory information required by IEC, UL and CSA standards (Copper conductors). All other data are provided as supplementary information only. For more details, please consult our CB, UL or CSA certificates and technical datasheet available on <http://www.TE.com>

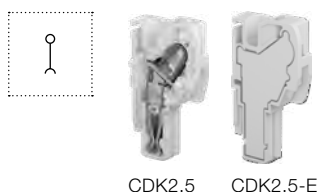

CDK2.5 CDK2.5-E

Female plugs

Description	Color	Type	Part number	Pkg qty	Weight (1 pce) g
Female plugs 1 pole	Grey <input type="checkbox"/>	CDK2.5	1SNK805712R0000	50	2.80
Female plugs without outer nubs - Closed 15 poles max.		CDK2.5-E	1SNK805713R0000	50	2.80

Accessories



Description	Color	Type	Part number	Pkg qty	Weight (1 pce) g	
1 End stops 5.2 mm 0.205 in	Dark grey <input type="checkbox"/>	BAZ1	1SNK900002R0000	50	5.30	
2 End sections 2.2 mm 0.087 in	Dark grey <input type="checkbox"/>	EDK2.5-22	1SNK805910R0000	20	3.15	
3 Jumper bars	Orange <input type="checkbox"/>	2 poles 32 A (IEC)	JB5-2	1SNK905302R0000	50	1.30
		3 poles 32 A (IEC)	JB5-3	1SNK905303R0000	50	2.00
		4 poles 32 A (IEC)	JB5-4	1SNK905304R0000	50	2.70
		5 poles 32 A (IEC)	JB5-5	1SNK905305R0000	50	3.50
		10 poles 32 A (IEC)	JB5-10	1SNK905310R0000	30	7.10
		50 poles 32 A (IEC)	JB5-50	1SNK905350R0000	10	36.00
4 Cross spacing jumpers 3 poles 32 A (IEC)	Orange <input type="checkbox"/>	JB85-3	1SNK900603R0000	10	2.80	
5 Circuit separators 3 mm 0.118 in	Dark grey <input type="checkbox"/>	CS-R3	1SNK900107R0000	20	6.40	
6 Test adapters	Dark grey <input type="checkbox"/>	For test plugs DIA 2 mm 0.079 in	TP2	1SNK900203R0000	20	1.70
		For test plugs DIA 4 mm 0.157 in	TP4	1SNK900205R0000	20	2.40
		5.2 mm 0.205 in spacing	TC5	1SNK900200R0000	10	5.20
7 Test connectors	Dark grey <input type="checkbox"/>	End module, 5.2 mm 0.205 in	TC5-R1	1SNK900201R0000	10	5.20
			COP-ZD	1SNK900636R0000	10	3.57
8 Coding pegs	Dark grey <input type="checkbox"/>	Blank marker	MG-CPM 13 41790	1960	0.23	
		Blank card	MC512	22	9.00	
			MC512PA	20	10.00	
			UMH	10	0.20	
9 Terminal block markers	Grey <input type="checkbox"/>	UMH	1SNK900611R0000	10	0.20	

Complete list of accessories is indicated in the terminal block datasheet including end stops.

Some accessories such as jumper bars may modify the terminal block's ratings: Complete information available in the accessories section of the catalog.

Technical data valid for copper conductors only.

ZDK4-22 PI-Spring pluggable terminal blocks

Feed-through - 6 mm 0.236 in spacing

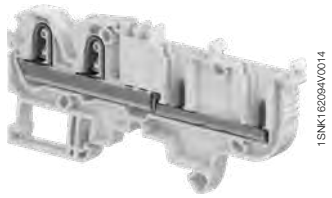

ZDK4-22

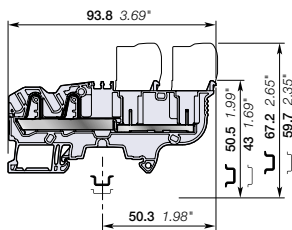

6 mm 0.236 in spacing

Description

- Increase your productivity with pluggable terminal blocks: possibility of pre-produced plugs harnesses, time saving plug and play assembly, reduced transportation panels preparation and final installation, easily connect sub-assemblies together,
- Simplify and secure your installation: in site faulty connection errors are eliminated, prior connection testing is eased and reliable, test connectors (TC5-R1 + ES-TC6) withstanding 10 000 operations are compatible for convenient testing.

Ordering details

Description	Color	Type	Part Number	Pkg qty	Weight (1 pce) g
Feed-through 4 connections	Grey <input type="checkbox"/>	ZDK4-22	1SNK806010R0000	50	14.30

Main technical data

Connecting capacity		IEC	UL - CSA
1 conductor per clamp	Rigid: Solid/Stranded	0.5 ... 6 mm ²	26 ... 10 AWG
	Flexible without ferrule	0.5 ... 4 mm ²	26 ... 12 AWG
	Flexible with non insulated ferrule	0.5 ... 4 mm ²	26 ... 12 AWG
	Flexible with insulated ferrule	0.5 ... 4 mm ²	26 ... 12 AWG
2 conductors per clamp	Flexible with twin ferrule	0.5 ... 1 mm ²	26 ... 18 AWG
Rated current / Rated cross section		30 A / 4 mm ²	30 A / 10 AWG
Rated short-time withstand current (1s)		480 A	
Rated voltage		1000 V	600 V
Impulse withstand voltage		8000 V	
Protection		IP20	NEMA 1

Mounting instructions

Rail		TH 35-7.5, TH 35-15
Wire stripping length		12.5 mm 0.492 in
Tool (for flexible conductor without ferrule)		Flat screwdriver Ø 3.5 mm Ø 0.138 in

The connecting capacity data for one Rigid: Solid/Stranded, or one Flexible conductor (when applicable) is a mandatory information required by IEC, UL and CSA standards (Copper conductors). All other data are provided as supplementary information only. For more details, please consult our CB, UL or CSA certificates and technical datasheet available on <http://www.TE.com>

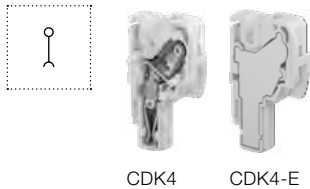
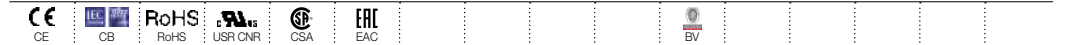

CDK4

CDK4-E

Female plugs

Description	Color	Type	Part Number	Pkg qty	Weight (1 pce) g
Female plugs 1 pole	Grey <input type="checkbox"/>	CDK4	1SNK806712R0000	50	3.80
Female plugs without outer nubs - Closed		CDK4-E	1SNK806713R0000	50	4.50

15 poles max.

Accessories

Description	Color	Type	Part Number	Pkg qty	Weight (1 pce) g			
1 End stops 5.2 mm 0.205 in	Dark grey <input checked="" type="checkbox"/>	BAZ1	1SNK900002R0000	50	5.30			
2 End sections 2.2 mm 0.087 in	Dark grey <input checked="" type="checkbox"/>	EDK2.5-22	1SNK805910R0000	20	3.15			
3 Jumper bars	Orange <input checked="" type="checkbox"/>	2 poles 41 A (IEC)	JB6-2	1SNK906302R0000	50	1.30		
		3 poles 41 A (IEC)	JB6-3	1SNK906303R0000	50	2.10		
		4 poles 41 A (IEC)	JB6-4	1SNK906304R0000	50	2.90		
		5 poles 41 A (IEC)	JB6-5	1SNK906305R0000	50	3.60		
		10 poles 41 A (IEC)	JB6-10	1SNK906310R0000	20	7.40		
50 poles 41 A (IEC)		JB6-50	1SNK906350R0000	10	38.10			
4 Cross spacing jumpers 3 poles 32 A (IEC)	Orange <input checked="" type="checkbox"/>	JB85-3	1SNK900603R0000	10	2.80			
5 Circuit separators 3 mm 0.118 in	Dark grey <input checked="" type="checkbox"/>	CS-R3	1SNK900107R0000	20	6.40			
6 Test adapters	Dark grey <input checked="" type="checkbox"/>	For test plugs DIA 2 mm 0.079 in	TP2	1SNK900203R0000	20	1.70		
		For test plugs DIA 4 mm 0.157 in	TP4	1SNK900205R0000	20	2.40		
7 Test connectors	Dark grey <input checked="" type="checkbox"/>	TC5-R1	1SNK900201R0000	10	5.20			
8 Spacers 0.8 mm 0.031 in	Dark grey <input checked="" type="checkbox"/>	ES-TC6	1SNK900105R0000	10	0.80			
9 Coding pegs	Dark grey <input checked="" type="checkbox"/>	COP-ZD	1SNK900636R0000	10	3.57			
			Blank marker	White <input type="checkbox"/>	MG-CPM 13 41791	1SNB041791R0612	1680	0.27
			Blank card		MC612	1SNK150000R0000	22	10.00
					MC612PA	1SNK159999R0000	20	11.00
Universal wire markers holder	Grey <input type="checkbox"/>	UMH	1SNK900611R0000	10	0.20			

Complete list of accessories is indicated in the terminal block datasheet including end stops.

Some accessories such as jumper bars may modify the terminal block's ratings: Complete information available in the accessories section of the catalog.

Technical data valid for copper conductors only.

ZDK2.5-11-PE PI-Spring pluggable terminal blocks

Ground - 5.2 mm 0.205 in spacing



1SNK16401900014

ZDK2.5-11-PE

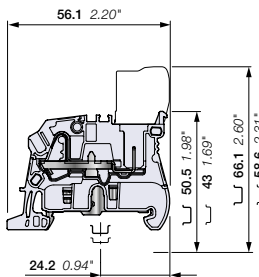

5.2 mm 0.205 in spacing

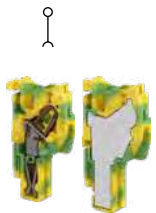

CDK2.5-PE CDK2.5-PE-E



Description

- Increase your productivity with pluggable terminal blocks: possibility of pre-produced plugs harnesses, time saving plug and play assembly, reduced transportation panels preparation and final installation, easily connect sub-assemblies together,
- Simplify and secure your installation: in site faulty connection errors are eliminated, prior connection testing is eased and reliable, test connectors (TC5) withstanding 10 000 operations are compatible for convenient testing.

Ordering details

Description	Color	Type	Part Number	Pkg qty	Weight (1 pce) g
Ground 2 connections	Green-yellow	ZDK2.5-11-PE	1SNK805150R0000	50	9.62

Main technical data

Connecting capacity	IEC	UL - CSA	Mounting instructions
1 conductor per clamp			
Rigid: Solid/Stranded	0.2 ... 4 mm²	26 ... 12 AWG	Rail TH 35-7.5, TH 35-15
Flexible without ferrule	0.22 ... 2.5 mm²		Wire stripping length 11 mm 0.433 in
Flexible with non insulated ferrule	0.22 ... 2.5 mm²	26 ... 14 AWG	
Flexible with insulated ferrule	0.22 ... 2.5 mm²	26 ... 14 AWG	Tool (for flexible conductor without ferrule) Flat screwdriver Ø 3.5 mm Ø 0.138 in
Rated cross section	2.5 mm²	12 AWG	
Rated short-time withstand current (1s)	300 A	396 A	
Protection	IP20	NEMA 1	

The connecting capacity data for one Rigid: Solid/Stranded, or one Flexible conductor (when applicable) is a mandatory information required by IEC, UL and CSA standards (Copper conductors). All other data are provided as supplementary information only. For more details, please consult our CB, UL or CSA certificates and technical datasheet available on <http://www.TE.com>

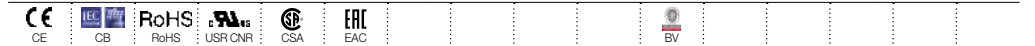

Female plugs

Description	Color	Type	Part Number	Pkg qty	Weight (1 pce) g
Female plugs 1 pole	Green-yellow	CDK2.5-PE	1SNK805750R0000	50	2.80
Female plugs without outer nubs - Closed 15 poles max.		CDK2.5-PE-E	1SNK805753R0000	50	2.88

Accessories

Description	Color	Type	Part Number	Pkg qty	Weight (1 pce) g
1 End stops 5.2 mm 0.205 in	Dark grey	BAZ1	1SNK900002R0000	50	5.30
2 End sections 1.5 mm 0.059 in	Dark grey	EDK2.5-11	1SNK805915R0000	20	1.49
3 Circuit separators 3 mm 0.118 in	Dark grey	CS-R2	1SNK900106R0000	20	3.80
4 Test adapters For test plugs DIA 2 mm 0.079 in For test plugs DIA 4 mm 0.157 in	Dark grey	TP2 TP4	1SNK900203R0000 1SNK900205R0000	20 20	1.70 2.40
5 Test connectors 5.2 mm 0.205 in spacing End module, 5.2 mm 0.205 in	Dark grey	TC5 TC5-R1	1SNK900200R0000 1SNK900201R0000	10 10	5.20 5.20
6 Coding pegs	Dark grey	COP-ZD	1SNK900636R0000	10	3.57
7 Terminal block markers Blank card	White	MC512 MC512PA	1SNK140000R0000 1SNK149999R0000	22 20	9.00 10.00
Blank marker		MG-CPM 13 41790	1SNB041790R0512	1960	0.236
Universal wire markers holder	Grey	UMH	1SNK900611R0000	10	0.20

Complete list of accessories is indicated in the terminal block datasheet including end stops. Some accessories such as jumper bars may modify the terminal block's ratings: Complete information available in the accessories section of the catalog.

Technical data valid for copper conductors only.

1SNK164024S0201

ZDK2.5-22-PE PI-Spring pluggable terminal blocks

Feed-through - 5.2 mm 0.205 in spacing

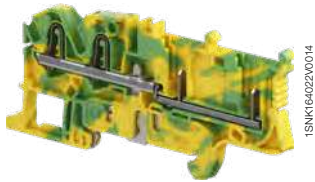

ZDK2.5-22-PE

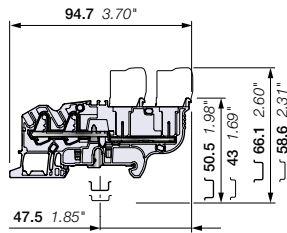

5.2 mm 0.205 in spacing

Description

- Increase your productivity with pluggable terminal blocks: possibility of pre-produced plugs harnesses, time saving plug and play assembly, reduced transportation panels preparation and final installation, easily connect sub-assemblies together,
- Simplify and secure your installation: in site faulty connection errors are eliminated, prior connection testing is eased and reliable, test connectors (TC5) withstanding 10 000 operations are compatible for convenient testing.

Ordering details

Description	Color	Type	Part Number	Pkg qty	Weight (1 pce) g
Ground 4 connections	Green-yellow	ZDK2.5-22-PE	1SNK805152R0000	50	14.05

Main technical data

Connecting capacity	IEC	UL - CSA	Mounting instructions
1 conductor per clamp	Rigid: Solid/Stranded	0.2 ... 4 mm ²	26 ... 12 AWG
	Flexible without ferrule	0.22 ... 2.5 mm ²	26 ... 14 AWG
	Flexible with non insulated ferrule	0.22 ... 2.5 mm ²	26 ... 14 AWG
	Flexible with insulated ferrule	0.22 ... 2.5 mm ²	26 ... 14 AWG
Rated cross section	2.5 mm ²	12 AWG	
Rated short-time withstand current (1s)	300 A	396 A	
Protection	IP20	NEMA 1	

Mounting instructions

Rail		TH 35-7.5, TH 35-15
Wire stripping length		11 mm 0.433 in
Tool (for flexible conductor without ferrule)		Flat screwdriver Ø 3.5 mm Ø 0.138 in

The connecting capacity data for one Rigid: Solid/Stranded, or one Flexible conductor (when applicable) is a mandatory information required by IEC, UL and CSA standards (Copper conductors). All other data are provided as supplementary information only. For more details, please consult our CB, UL or CSA certificates and technical datasheet available on <http://www.TE.com>

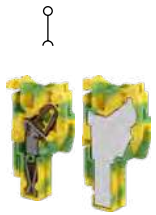

CDK2.5-PE CDK2.5-PE-E

Female plugs

Description	Color	Type	Part Number	Pkg qty	Weight (1 pce) g
Female plugs 1 pole	Green-yellow	CDK2.5-PE	1SNK805750R0000	50	2.80
Female plugs without outer nubs - Closed 1 pole		CDK2.5-PE-E	1SNK805753R0000	50	2.88

15 poles max.

Accessories

Description	Color	Type	Part Number	Pkg qty	Weight (1 pce) g	
1 End stops 5.2 mm 0.205 in	Dark grey	BAZ1	1SNK900002R0000	50	5.30	
2 End sections 2.2 mm 0.087 in	Dark grey	EDK2.5-22	1SNK805910R0000	20	3.15	
3 Circuit separators 3 mm 0.118 in	Dark grey	CS-R3	1SNK900107R0000	20	6.40	
4 Test adapters	Dark grey	For test plugs DIA 2 mm 0.079 in	TP2	1SNK900203R0000	20	1.70
		For test plugs DIA 4 mm 0.157 in	TP4	1SNK900205R0000	20	2.40
5 Test connectors 5.2 mm 0.205 in spacing	Dark grey	End module, 5.2 mm 0.205 in	TC5	1SNK900200R0000	10	5.20
			TC5-R1	1SNK900201R0000	10	5.20
6 Coding pegs	Dark grey	COP-ZD	1SNK900636R0000	10	3.57	
7 Terminal block markers	White	Blank card	MC512	1SNK140000R0000	22	9.00
		Blank marker	MC512PA	1SNK149999R0000	20	10.00
			MG-CPM 13 41790	1SNB041790R0512	1960	0.236
		Universal wire markers holder	UMH	1SNK900611R0000	10	0.20

Complete list of accessories is indicated in the terminal block datasheet including end stops. Some accessories such as jumper bars may modify the terminal block's ratings: Complete information available in the accessories section of the catalog.

Technical data valid for copper conductors only.

ZDK2.5-D2 PI-Spring pluggable terminal blocks

Double deck feed-through 2 circuits - 5.2 mm 0.205 in spacing

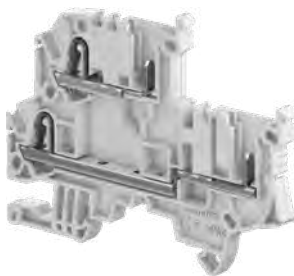

1SNK16402300014

ZDK2.5-D2

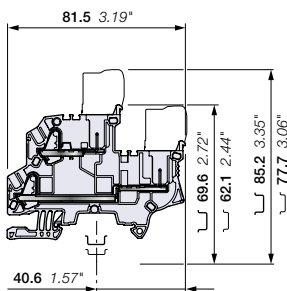

5.2 mm 0.205 in spacing

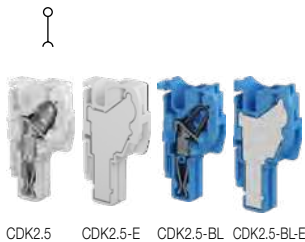

CDK2.5 CDK2.5-E CDK2.5-BL CDK2.5-BL-E



Description

- Increase your productivity with pluggable terminal blocks: possibility of pre-produced plugs harnesses, time saving plug and play assembly, reduced transportation panels preparation and final installation, easily connect sub-assemblies together,
- Simplify and secure your installation: in site faulty connection errors are eliminated, prior connection testing is eased and reliable, test connectors (TC5) withstanding 10 000 operations are compatible for convenient testing.

Ordering details

Description	Color	Type	Part Number	Pkg qty	Weight (1 pce) g
Feed-through double deck 4 connections	Grey <input type="checkbox"/>	ZDK2.5-D2	1SNK805213R0000	50	11.89
	Blue <input type="checkbox"/>	ZDK2.5-D2-BL	1SNK805223R0000	50	11.89

Main technical data

Connecting capacity	IEC	UL - CSA	Mounting instructions
1 conductor per clamp	Rigid: Solid/Stranded	0.2 ... 4 mm ²	26 ... 12 AWG
	Flexible without ferrule	0.22 ... 2.5 mm ²	26 ... 14 AWG
	Flexible with non insulated ferrule	0.22 ... 2.5 mm ²	26 ... 14 AWG
	Flexible with insulated ferrule	0.22 ... 2.5 mm ²	26 ... 14 AWG
2 conductors per clamp	Flexible with twin ferrule	0.22 ... 0.5 mm ²	26 ... 20 AWG
Rated current / Rated cross section	22 A / 2.5 mm ²	20 A / 12 AWG	
Rated short-time withstand current (1s)	300 A		
Rated voltage	800 V	600 V	
Impulse withstand voltage	8000 V		
Protection	IP20	NEMA 1	

The connecting capacity data for one Rigid: Solid/Stranded, or one Flexible conductor (when applicable) is a mandatory information required by IEC, UL and CSA standards (Copper conductors). All other data are provided as supplementary information only. For more details, please consult our CB, UL or CSA certificates and technical datasheet available on <http://www.TE.com>

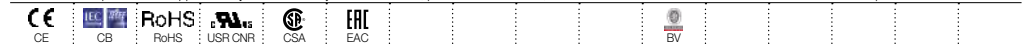

Female plugs

Description	Color	Type	Part Number	Pkg qty	Weight (1 pce) g
Female plugs 1 pole	Grey <input type="checkbox"/>	CDK2.5	1SNK805712R0000	50	2.80
Female plugs without outer nubs - Closed		CDK2.5-E	1SNK805713R0000	50	2.88
Female plugs 1 pole	Blue <input type="checkbox"/>	CDK2.5-BL	1SNK805742R0000	50	2.80
Female plugs without outer nubs - Closed		CDK2.5-BL-E	1SNK805743R0000	50	2.88

15 poles max.

Accessories

Description	Color	Type	Part Number	Pkg qty	Weight (1 pce) g	
1 End stops 5.2 mm 0.205 in	Dark grey <input type="checkbox"/>	BAZ1	1SNK900002R0000	50	5.30	
2 End sections 2.0 mm 0.079 in	Dark grey <input type="checkbox"/>	EDK2.5-D	1SNK805913R0000	20	3.88	
3 Jumper bars	Orange <input type="checkbox"/>	2 poles 32 A (IEC)	JB5-2	1SNK905302R0000	50	1.30
		3 poles 32 A (IEC)	JB5-3	1SNK905303R0000	50	2.00
		4 poles 32 A (IEC)	JB5-4	1SNK905304R0000	50	2.70
		5 poles 32 A (IEC)	JB5-5	1SNK905305R0000	50	3.50
		10 poles 32 A (IEC)	JB5-10	1SNK905310R0000	30	7.10
		50 poles 32 A (IEC)	JB5-50	1SNK905350R0000	10	36.00
4 Cross spacing jumpers 3 poles 32 A (IEC)	Orange <input type="checkbox"/>	JB85-3	1SNK900603R0000	10	2.80	
5 Test adapters	Dark grey <input type="checkbox"/>	For test plugs DIA 2 mm 0.079 in	TP2	1SNK900203R0000	20	1.70
		For test plugs DIA 4 mm 0.157 in	TP4	1SNK900205R0000	20	2.40
6 Test connectors	Dark grey <input type="checkbox"/>	5.2 mm 0.205 in spacing	TC5	1SNK900200R0000	10	5.20
		End module, 5.2 mm 0.205 in	TC5-R1	1SNK900201R0000	10	5.20
7 Coding pegs	Dark grey <input type="checkbox"/>	COP-ZD	1SNK900636R0000	10	3.57	
		MC512	1SNK140000R0000	22	9.00	
		MC512PA	1SNK149999R0000	20	10.00	
		MG-CPM 13 41790	1SNB041790R0512	1960	0.236	
8 Terminal block markers	White <input type="checkbox"/>	Blank card				
		Blank marker				
	Grey <input type="checkbox"/>	UMH	1SNK900611R0000	10	0.20	

Complete list of accessories is indicated in the terminal block datasheet including end stops. Some accessories such as jumper bars may modify the terminal block's ratings: Complete information available in the accessories section of the catalog.

Technical data valid for copper conductors only.

ZDK2.5-D1 PI-Spring pluggable terminal blocks

Double deck feed-through 1 circuit - 5.2 mm 0.205 in spacing

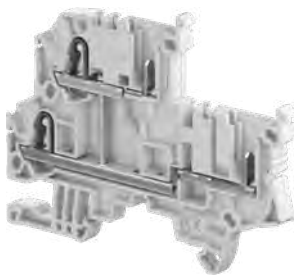

1SNK16425V0014

ZDK2.5-D1

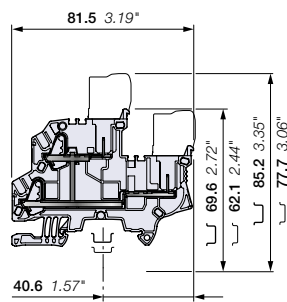

5.2 mm 0.205 in spacing

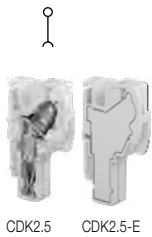

CDK2.5 CDK2.5-E



1 2 3 4 5 6 7 8

Description

- Increase your productivity with pluggable terminal blocks: possibility of pre-produced plugs harnesses, time saving plug and play assembly, reduced transportation panels preparation and final installation, easily connect sub-assemblies together,
- Simplify and secure your installation: in site faulty connection errors are eliminated, prior connection testing is eased and reliable, test connectors (TC5) withstanding 10 000 operations are compatible for convenient testing.

Ordering details

Description	Color	Type	Part Number	Pkg qty	Weight (1 pce) g
Feed-through double deck 4 connections	Grey <input type="checkbox"/>	ZDK2.5-D1	1SNK805214R0000	50	12.46

Main technical data

Connecting capacity	IEC	UL - CSA	Rail	TH 35-7.5, TH 35-15
1 conductor per clamp	Rigid: Solid/Stranded	0.2 ... 4 mm ²	26 ... 12 AWG	11 mm 0.433 in
	Flexible without ferrule	0.22 ... 2.5 mm ²	26 ... 14 AWG	
	Flexible with non insulated ferrule	0.22 ... 2.5 mm ²	26 ... 14 AWG	
	Flexible with insulated ferrule	0.22 ... 2.5 mm ²	26 ... 14 AWG	
2 conductors per clamp	Flexible with twin ferrule	0.22 ... 0.5 mm ²	26 ... 20 AWG	Flat screwdriver Ø 3.5 mm Ø 0.138 in
Rated current / Rated cross section	22 A / 2.5 mm ²	20 A / 12 AWG		
Rated short-time withstand current (1s)	300 A			
Rated voltage	800 V	600 V		
Impulse withstand voltage	8000 V			
Protection	IP20	NEMA 1		

The connecting capacity data for one Rigid: Solid/Stranded, or one Flexible conductor (when applicable) is a mandatory information required by IEC, UL and CSA standards (Copper conductors). All other data are provided as supplementary information only. For more details, please consult our CB, UL or CSA certificates and technical datasheet available on <http://www.TE.com>

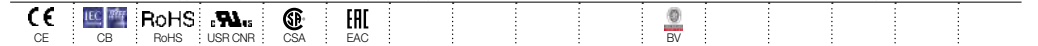

Female plugs

Description	Color	Type	Part Number	Pkg qty	Weight (1 pce) g
Female plugs 1 pole	Grey	<input type="checkbox"/> CDK2.5	1SNK805712R0000	50	2.80
Female plugs without outer nubs - Closed 15 poles max.		<input type="checkbox"/> CDK2.5-E	1SNK805713R0000	50	2.88

Accessories

Description	Color	Type	Part Number	Pkg qty	Weight (1 pce) g	
1 End stops 5.2 mm 0.205 in	Dark grey <input type="checkbox"/>	BAZ1	1SNK900002R0000	50	5.30	
2 End sections 2.0 mm 0.079 in	Dark grey <input type="checkbox"/>	EDK2.5-D	1SNK805913R0000	20	3.88	
3 Jumper bars 2 poles 32 A (IEC)	Orange <input type="checkbox"/>	JB5-2	1SNK905302R0000	50	1.30	
		3 poles 32 A (IEC)	JB5-3	1SNK905303R0000	50	2.00
		4 poles 32 A (IEC)	JB5-4	1SNK905304R0000	50	2.70
		5 poles 32 A (IEC)	JB5-5	1SNK905305R0000	50	3.50
		10 poles 32 A (IEC)	JB5-10	1SNK905310R0000	30	7.10
		50 poles 32 A (IEC)	JB5-50	1SNK905350R0000	10	36.00
4 Cross spacing jumpers 3 poles 32 A (IEC)	Orange <input type="checkbox"/>	JB85-3	1SNK900603R0000	10	2.80	
5 Test adapters For test plugs DIA 2 mm 0.079 in For test plugs DIA 4 mm 0.157 in	Dark grey <input type="checkbox"/>	TP2	1SNK900203R0000	20	1.70	
		TP4	1SNK900205R0000	20	2.40	
6 Test connectors 5.2 mm 0.205 in spacing End module, 5.2 mm 0.205 in	Dark grey <input type="checkbox"/>	TC5	1SNK900200R0000	10	5.20	
		TC5-R1	1SNK900201R0000	10	5.20	
7 Coding pegs	Dark grey <input type="checkbox"/>	COP-ZD	1SNK900636R0000	10	3.57	
		MC512	1SNK140000R0000	22	9.00	
		MC512PA	1SNK149999R0000	20	10.00	
8 Terminal block markers	White <input type="checkbox"/>	MG-CPM 13 41790	1SNB041790R0512	1960	0.236	
		Universal wire markers holder	Grey <input type="checkbox"/>	UMH	1SNK900611R0000	10

Complete list of accessories is indicated in the terminal block datasheet including end stops. Some accessories such as jumper bars may modify the terminal block's ratings: Complete information available in the accessories section of the catalog.

Technical data valid for copper conductors only.

ZDK2.5-D2-PE PI-Spring pluggable terminal blocks

Double deck feed-through + ground - 5.2 mm 0.205 in spacing

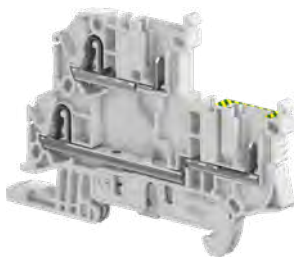

1SNK1640ZV0014

ZDK2.5-D2-PE

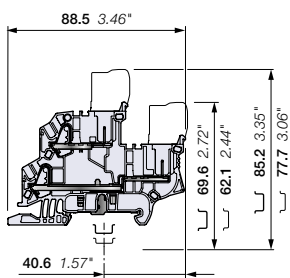

5.2 mm 0.205 in spacing

Description

- Increase your productivity with pluggable terminal blocks: possibility of pre-produced plugs harnesses, time saving plug and play assembly, reduced transportation panels preparation and final installation, easily connect sub-assemblies together,
- Simplify and secure your installation: in site faulty connection errors are eliminated, prior connection testing is eased and reliable, test connectors (TC5) withstanding 10 000 operations are compatible for convenient testing.

Ordering details

Description	Color	Type	Part Number	Pkg qty	Weight (1 pce) g	
Feed-through + ground	double deck 4 connections	Grey, Green-yellow	ZDK2.5-D2-PE	1SNK805212R0000	50	16.13

Main technical data

Connecting capacity	IEC	UL - CSA	Mounting instructions
1 conductor per clamp	Rigid: Solid/Stranded	0.2 ... 4 mm ²	26 ... 12 AWG
	Flexible without ferrule	0.22 ... 2.5 mm ²	26 ... 14 AWG
	Flexible with non insulated ferrule	0.22 ... 2.5 mm ²	26 ... 14 AWG
	Flexible with insulated ferrule	0.22 ... 2.5 mm ²	26 ... 14 AWG
2 conductors per clamp	Flexible with twin ferrule	0.22 ... 0.5 mm ²	26 ... 20 AWG
Rated current / Rated cross section	22 A / 2.5 mm ²	20 A / 12 AWG	
Rated short-time withstand current (1s)	300 A	396 A	
Rated voltage	800 V	600 V	
Impulse withstand voltage	8000 V		
Protection	IP20	NEMA 1	

The connecting capacity data for one Rigid: Solid/Stranded, or one Flexible conductor (when applicable) is a mandatory information required by IEC, UL and CSA standards (Copper conductors). All other data are provided as supplementary information only. For more details, please consult our CB, UL or CSA certificates and technical datasheet available on <http://www.TE.com>

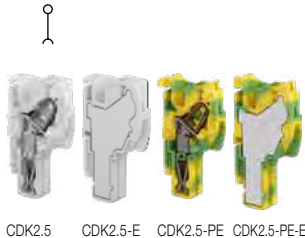

CDK2.5 CDK2.5-E CDK2.5-PE CDK2.5-PE-E

Female plugs

Description	Color	Type	Part Number	Pkg qty	Weight (1 pce) g	
Female plugs	1 pole	Grey	CDK2.5	1SNK805712R0000	50	2.80
Female plugs without outer nubs - Closed	1 pole		CDK2.5-E	1SNK805713R0000	50	2.88
Female plugs	1 pole	Green-yellow	CDK2.5-PE	1SNK805750R0000	50	2.80
Female plugs without outer nubs - Closed	1 pole		CDK2.5-PE-E	1SNK805753R0000	50	2.88

15 poles max.

Accessories



Description	Color	Type	Part Number	Pkg qty	Weight (1 pce) g	
1 End stops	5.2 mm 0.205 in	Dark grey	BAZ1	1SNK900002R0000	50	5.30
2 End sections	2.0 mm 0.079 in	Dark grey	EDK2.5-D	1SNK805913R0000	20	3.88
3 Jumper bars	2 poles	32 A (IEC)	JB5-2	1SNK905302R0000	50	1.30
	3 poles	32 A (IEC)	JB5-3	1SNK905303R0000	50	2.00
	4 poles	32 A (IEC)	JB5-4	1SNK905304R0000	50	2.70
	5 poles	32 A (IEC)	JB5-5	1SNK905305R0000	50	3.50
	10 poles	32 A (IEC)	JB5-10	1SNK905310R0000	30	7.10
	50 poles	32 A (IEC)	JB5-50	1SNK905350R0000	10	36.00
4 Cross spacing jumpers	3 poles	32 A (IEC)	JB85-3	1SNK900603R0000	10	2.80
5 Test adapters	For test plugs DIA 2 mm 0.079 in	Dark grey	TP2	1SNK900203R0000	20	1.70
	For test plugs DIA 4 mm 0.157 in		TP4	1SNK900205R0000	20	2.40
6 Test connectors	5.2 mm 0.205 in spacing	Dark grey	TC5	1SNK900200R0000	10	5.20
	End module, 5.2 mm 0.205 in		TC5-R1	1SNK900201R0000	10	5.20
7 Coding pegs		Dark grey	COP-ZD	1SNK900636R0000	10	3.57
		White	MC512	1SNK140000R0000	22	9.00
			MC512PA	1SNK149999R0000	20	10.00
8 Terminal block markers	Blank card		MG-CPM 13 41790	1SNB041790R0512	1960	0.236
	Blank marker		UMH	1SNK900611R0000	10	0.20

Complete list of accessories is indicated in the terminal block datasheet including end stops. Some accessories such as jumper bars may modify the terminal block's ratings: Complete information available in the accessories section of the catalog.

Technical data valid for copper conductors only.

ZDK2.5-D1-PE PI-Spring pluggable terminal blocks

Double deck ground - 5.2 mm 0.205 in spacing

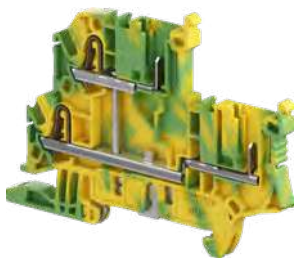

1SNK16402B0004

ZDK2.5-D1-PE

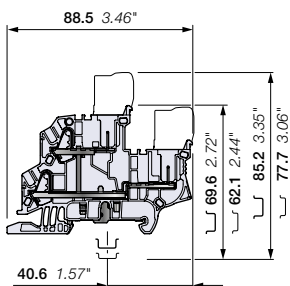

5.2 mm 0.205 in spacing

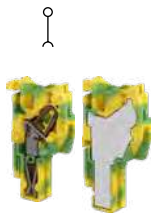

CDK2.5-PE CDK2.5-PE-E



Description

- Increase your productivity with pluggable terminal blocks: possibility of pre-produced plugs harnesses, time saving plug and play assembly, reduced transportation panels preparation and final installation, easily connect sub-assemblies together,
- Simplify and secure your installation: in site faulty connection errors are eliminated, prior connection testing is eased and reliable, test connectors (TC5) withstanding 10 000 operations are compatible for convenient testing.

Ordering details

Description	Color	Type	Part Number	Pkg qty	Weight (1 pce) g
Ground double deck 4 connections	Green-yellow	ZDK2.5-D1-PE	1SNK805250R0000	50	16.80

Main technical data

Connecting capacity	IEC	UL - CSA	Mounting instructions		
1 conductor per clamp	Rigid: Solid/Stranded	0.2 ... 4 mm ²	26 ... 12 AWG	Rail	TH 35-7.5, TH 35-15
	Flexible without ferrule	0.22 ... 2.5 mm ²	26 ... 14 AWG	Wire stripping length	11 mm 0.433 in
	Flexible with non insulated ferrule	0.22 ... 2.5 mm ²	26 ... 14 AWG		Tool (for flexible conductor without ferrule)
	Flexible with insulated ferrule	0.22 ... 2.5 mm ²	26 ... 14 AWG		
Rated cross section	2.5 mm ²	12 AWG			
Rated short-time withstand current (1s)	300 A	396 A			
Protection	IP20	NEMA 1			

The connecting capacity data for one Rigid: Solid/Stranded, or one Flexible conductor (when applicable) is a mandatory information required by IEC, UL and CSA standards (Copper conductors). All other data are provided as supplementary information only. For more details, please consult our CB, UL or CSA certificates and technical datasheet available on <http://www.TE.com>

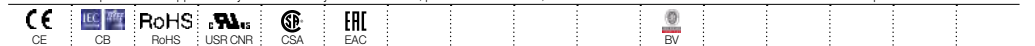

Female plugs

Description	Color	Type	Part Number	Pkg qty	Weight (1 pce) g
Female plugs 1 pole	Green-yellow	CDK2.5-PE	1SNK805750R0000	50	2.80
Female plugs without outer nubs - Closed		CDK2.5-PE-E	1SNK805753R0000	50	2.88

15 poles max.

Accessories

Description	Color	Type	Part Number	Pkg qty	Weight (1 pce) g
1 End stops 5.2 mm 0.205 in	Dark grey	BAZ1	1SNK900002R0000	50	5.30
2 End sections 2.0 mm 0.079 in	Dark grey	EDK2.5-D	1SNK805913R0000	20	3.88
3 Test adapters	Dark grey	TP2	1SNK900203R0000	20	1.70
	Dark grey	TP4	1SNK900205R0000	20	2.40
4 Test connectors 5.2 mm 0.205 in spacing	Dark grey	TC5	1SNK900200R0000	10	5.20
	Dark grey	TC5-R1	1SNK900201R0000	10	5.20
5 Coding pegs	Dark grey	COP-ZD	1SNK900636R0000	10	3.57
6 Terminal block markers	White	MC512	1SNK140000R0000	22	9.00
	White	MC512PA	1SNK149999R0000	20	10.00
	Grey	UMH	1SNK900611R0000	10	0.20

Complete list of accessories is indicated in the terminal block datasheet including end stops. Some accessories such as jumper bars may modify the terminal block's ratings: Complete information available in the accessories section of the catalog.

Technical data valid for copper conductors only.

CDK2.5 PI-Spring female plugs

Female plug - 5.2 mm 0.205 in spacing

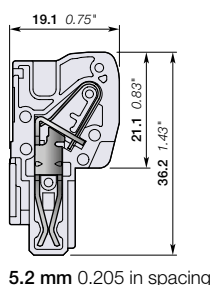
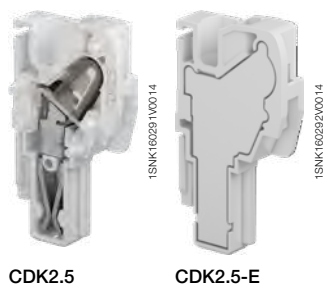

Description

- Create your own female plug assemblies without any special tools, easily snap together multiple plugs for optimal ergonomics and quick assembly,
- Increase your flexibility: eliminate stock of pre-configured female plugs, easily add an extra plug in case of needed modification,
- Reduce your stock of unitary plugs up to 30%: only two plug variants are required to compose your own subsets of plugs from 2 to 15 poles.

Ordering details

Description	Color	Type	Part number	Pkg qty	Weight (1 pce) g
Female plugs	Grey	CDK2.5	1SNK805712R0000	50	2.80
	Blue	CDK2.5-BL	1SNK805742R0000	50	2.80
	Green-Yellow	CDK2.5-PE	1SNK805750R0000	50	2.80
Female plugs without outer nubs - Closed	Grey	CDK2.5-E	1SNK805713R0000	50	2.80
	Blue	CDK2.5-BL-E	1SNK805743R0000	50	2.80
	Green-Yellow	CDK2.5-PE-E	1SNK805753R0000	50	2.80

Main technical data

Connecting capacity		IEC	UL - CSA	Mounting instructions	
1 conductor per clamp	Rigid: Solid/Stranded	0.2 ... 4 mm²	26 ... 12 AWG	Rail	
	Flexible without ferrule	0.22 ... 2.5 mm²		Wire stripping length	11 mm 0.433 in
	Flexible with non insulated ferrule	0.22 ... 2.5 mm²	26 ... 14 AWG		
	Flexible with insulated ferrule	0.22 ... 2.5 mm²	26 ... 14 AWG		
2 conductors per clamp	Flexible with twin ferrule	0.22 ... 0.5 mm²	26 ... 20 AWG	Tool (for flexible conductor without ferrule)	Flat screwdriver Ø 3.5 mm Ø 0.138 in
Rated current / Rated cross section		24 A / 2.5 mm²	22 A / 12 AWG		
Rated short-time withstand current (1s)		300 A			
Rated voltage		1000 V	600 V		
Impulse withstand voltage		8000 V			
Protection		IP20	NEMA 1		

The connecting capacity data for one Rigid: Solid/Stranded, or one Flexible conductor (when applicable) is a mandatory information required by IEC, UL and CSA standards (Copper conductors). All other data are provided as supplementary information only. For more details, please consult our CB, UL or CSA certificates and technical datasheet available on <http://www.TE.com>

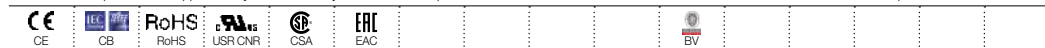

Mounting instructions



Accessories

Description	Color	Type	Part number	Pkg qty	Weight (1 pce) g
1 Locking devices	Black	VR-ZD	1SNK900637R0000	50	0.7
2 Cable clamp	Dark grey	PT-ZD	1SNK900660R0000	50	1.04
3 Terminal block markers	White	MG-CPM 13 41790	1SNB041790R0512	1960	0.23
		MG-CPMFA 43196	1SNB043196R0012	350	2.56
		MC512	1SNK140000R0000	22	9.00
		MC512PA	1SNK149999R0000	20	10.00
	Universal wire markers holder	Grey	UMH	1SNK900611R0000	10

Complete list of accessories is indicated in the terminal block datasheet including end stops. Some accessories such as jumper bars may modify the terminal block's ratings: Complete information available in the accessories section of the catalog.

Technical data valid for copper conductors only.

CDK2.5-J PI-Spring female plugs

Female plug - 5.2 mm 0.205 in spacing

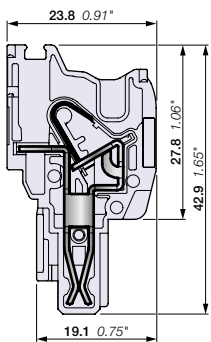
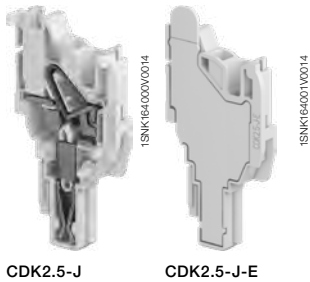

5.2 mm 0.205 in spacing

Description

- Create your own female plug assemblies without any special tools, easily snap together multiple plugs for optimal ergonomics and quick assembly,
- Increase your flexibility: eliminate stock of pre-configured female plugs, easily add an extra plug in case of needed modification,
- Reduce your stock of unitary plugs up to 30%: only two plug variants are required to compose your own subsets of plugs from 2 to 15 poles.

Description	Color	Type	Part Number	Pkg qty	Weight (1 pce) g
Female plugs	Grey	CDK2.5-J	1SNK805738R0000	50	4.08
	Blue	CDK2.5-J-BL	1SNK805744R0000	50	4.08
	Green-yellow	CDK2.5-J-PE	1SNK805748R0000	50	4.08
Female plugs without outer nubs - Closed	Grey	CDK2.5-J-E	1SNK805739R0000	50	4.34
	Blue	CDK2.5-J-BL-E	1SNK805745R0000	50	4.34
	Green-yellow	CDK2.5-J-PE-E	1SNK805749R0000	50	4.34

Main technical data

Connecting capacity		IEC	UL - CSA	Mounting instructions	
1 conductor per clamp	Rigid: Solid/Stranded	0.2 ... 4 mm ²	26 ... 12 AWG	Wire stripping length	11 mm 0.433 in
	Flexible without ferrule	0.22 ... 2.5 mm ²			
	Flexible with non insulated ferrule	0.22 ... 2.5 mm ²	26 ... 14 AWG	Tool (for flexible conductor without ferrule)	Flat screwdriver Ø 3.5 mm Ø 0.138 in
	Flexible with insulated ferrule	0.22 ... 2.5 mm ²	26 ... 14 AWG		
2 conductors per clamp	Flexible with twin ferrule	0.22 ... 0.5 mm ²	26 ... 20 AWG		
Rated current / Rated cross section		24 A / 2.5 mm ²	20 A / 12 AWG		
Rated short-time withstand current (1s)		300 A			
Rated voltage		800 V	600 V		
Impulse withstand voltage		8000 V			
Protection		IP20	NEMA 1		

The connecting capacity data for one Rigid: Solid/Stranded, or one Flexible conductor (when applicable) is a mandatory information required by IEC, UL and CSA standards (Copper conductors). All other data are provided as supplementary information only. For more details, please consult our CB, UL or CSA certificates and technical datasheet available on <http://www.TE.com>



Mounting instructions



Accessories



Description	Color	Type	Part Number	Pkg qty	Weight (1 pce) g	
1 Jumper bars	Orange	2 poles 32 A (IEC)	JB5-2	1SNK905302R0000	50	1.30
		3 poles 32 A (IEC)	JB5-3	1SNK905303R0000	50	2.00
		4 poles 32 A (IEC)	JB5-4	1SNK905304R0000	50	2.70
		5 poles 32 A (IEC)	JB5-5	1SNK905305R0000	50	3.50
		10 poles 32 A (IEC)	JB5-10	1SNK905310R0000	30	7.10
		50 poles 32 A (IEC)	JB5-50	1SNK905350R0000	10	36.00
2 Test adapters	Dark grey	For test plugs DIA 2 mm 0.079 in	TP2	1SNK900203R0000	20	1.70
		For test plugs DIA 4 mm 0.157 in	TP4	1SNK900205R0000	20	2.40
3 Test connectors	Dark grey	5.2 mm 0.205 in spacing	TC5	1SNK900200R0000	10	5.20
		End module, 5.2 mm 0.205 in	TC5-R1	1SNK900201R0000	10	5.20
4 Locking devices	Black	VR-ZD	1SNK900637R0000	50	0.7	
5 Strain Relief	Dark grey	PT-ZD	1SNK900660R0000	50	1.04	
6 Terminal block markers	White	Blank card	MC512	1SNK140000R0000	22	9.00
			MC512PA	1SNK149999R0000	20	10.00
	Blank strip label	MG-CPMFA 43196	1SNB043196R0012	400	2.562	
	Blank marker	MG-CPM 13 41790	1SNB041790R0512	1960	0.236	
	Universal wire markers holder	Grey	UMH	1SNK900611R0000	10	0.20

Complete list of accessories is indicated in the terminal block datasheet including end stops.

Some accessories such as jumper bars may modify the terminal block's ratings: Complete information available in the accessories section of the catalog.

Technical data valid for copper conductors only.

CDK2.5-2P-J PI-Spring female plugs

Female plug - 5.2 mm 0.205 in spacing

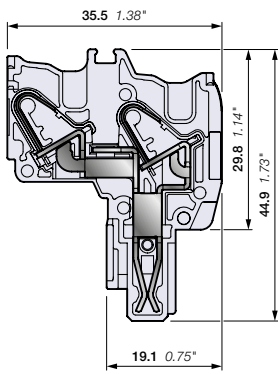
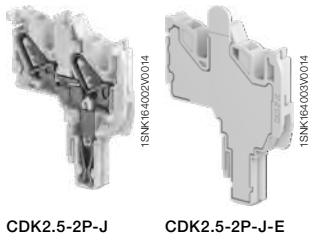

5.2 mm 0.205 in spacing

Description

- Create your own female plug assemblies without any special tools, easily snap together multiple plugs for optimal ergonomics and quick assembly,
- Increase your flexibility: eliminate stock of pre-configured female plugs, easily add an extra plug in case of needed modification,
- Reduce your stock of unitary plugs up to 30%: only two plug variants are required to compose your own subsets of plugs from 2 to 15 poles.

Description	Color	Type	Part Number	Pkg qty	Weight (1 pce) g
Female plugs	Grey	<input type="checkbox"/> CDK2.5-2P-J	1SNK805740R0000	50	5.37
	Blue	<input type="checkbox"/> CDK2.5-2P-J-BL	1SNK805746R0000	50	5.37
	Green-yellow	<input type="checkbox"/> CDK2.5-2P-J-PE	1SNK805751R0000	50	5.37
Female plugs without outer nubs - Closed	Grey	<input type="checkbox"/> CDK2.5-2P-J-E	1SNK805741R0000	50	5.74
	Blue	<input type="checkbox"/> CDK2.5-2P-J-BL-E	1SNK805747R0000	50	5.74
	Green-yellow	<input type="checkbox"/> CDK2.5-2P-J-PE-E	1SNK805752R0000	50	5.74

Main technical data

Connecting capacity	IEC	UL - CSA	Rail
1 conductor per clamp	Rigid: Solid/Stranded	0.2 ... 4 mm²	26 ... 12 AWG
	Flexible without ferrule	0.22 ... 2.5 mm²	
	Flexible with non insulated ferrule	0.22 ... 2.5 mm²	26 ... 14 AWG
	Flexible with insulated ferrule	0.22 ... 2.5 mm²	26 ... 14 AWG
2 conductors per clamp	Flexible with twin ferrule	0.22 ... 0.5 mm²	26 ... 20 AWG
Rated current / Rated cross section	24 A / 2.5 mm²	20 A / 12 AWG	
Rated short-time withstand current (1s)	300 A		
Rated voltage	500 V	600 V	
Impulse withstand voltage	6000 V		
Protection	IP20	NEMA 1	

Mounting instructions

Wire stripping length	Tool (for flexible conductor without ferrule)	Flat screwdriver
11 mm 0.433 in		Ø 3.5 mm Ø 0.138 in

The connecting capacity data for one Rigid: Solid/Stranded, or one Flexible conductor (when applicable) is a mandatory information required by IEC, UL and CSA standards (Copper conductors). All other data are provided as supplementary information only. For more details, please consult our CB, UL or CSA certificates and technical datasheet available on <http://www.TE.com>



Mounting instructions



Accessories

Description	Color	Type	Part Number	Pkg qty	Weight (1 pce) g	
1 Jumper bars	Orange	2 poles 32 A (IEC)	JB5-2	1SNK905302R0000	50	1.30
		3 poles 32 A (IEC)	JB5-3	1SNK905303R0000	50	2.00
		4 poles 32 A (IEC)	JB5-4	1SNK905304R0000	50	2.70
		5 poles 32 A (IEC)	JB5-5	1SNK905305R0000	50	3.50
		10 poles 32 A (IEC)	JB5-10	1SNK905310R0000	30	7.10
		50 poles 32 A (IEC)	JB5-50	1SNK905350R0000	10	36.00
2 Test adapters	Dark grey	For test plugs DIA 2 mm 0.079 in	TP2	1SNK900203R0000	20	1.70
		For test plugs DIA 4 mm 0.157 in	TP4	1SNK900205R0000	20	2.40
3 Test connectors	Dark grey	5.2 mm 0.205 in spacing	TC5	1SNK900200R0000	10	5.20
		End module, 5.2 mm 0.205 in	TC5-R1	1SNK900201R0000	10	5.20
4 Locking devices	Black	VR-ZD	1SNK900637R0000	50	0.7	
5 Strain Relief	Dark grey	PT-ZD	1SNK900660R0000	50	1.04	
6 Terminal block markers	White	MC512	1SNK140000R0000	22	9.00	
		MC512PA	1SNK149999R0000	20	10.00	
	Blank strip label	MG-CPMFA 43196	1SNB043196R0012	400	2.562	
	Blank marker	MG-CPM 13 41790	1SNB041790R0512	1960	0.236	
Universal wire markers holder	Grey	UMH	1SNK900611R0000	10	0.20	

Complete list of accessories is indicated in the terminal block datasheet including end stops.

Some accessories such as jumper bars may modify the terminal block's ratings: Complete information available in the accessories section of the catalog.

Technical data valid for copper conductors only.

1SNK1640350201

CDK4 PI-Spring female plugs

Female plug - 6 mm 0.236 in spacing

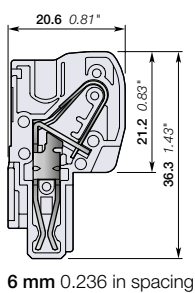
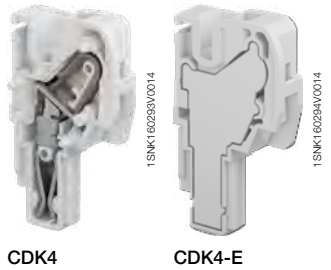

Description

- Create your own female plug assemblies without any special tools, easily snap together multiple plugs for optimal ergonomics and quick assembly,
- Increase your flexibility: eliminate stock of pre-configured female plugs, easily add an extra plug in case of needed modification,
- Reduce your stock of unitary plugs up to 30%: only two plug variants are required to compose your own subsets of plugs from 2 to 15 poles.

Ordering details

Description	Color	Type	Part Number	Pkg qty	Weight (1 pce) g
Female plugs	Grey <input type="checkbox"/>	CDK4	1SNK806712R0000	50	3.80
Female plugs without outer nubs - Closed		CDK4-E	1SNK806713R0000	50	4.50

Main technical data

Connecting capacity		IEC	UL - CSA	Mounting instructions	
1 conductor per clamp	Rigid: Solid/Stranded	0.5 ... 6 mm²	26 ... 10 AWG	Wire stripping length	12.5 mm 0.492 in
	Flexible without ferrule	0.5 ... 4 mm²			
	Flexible with non insulated ferrule	0.5 ... 4 mm²	26 ... 12 AWG	Tool (for flexible conductor without ferrule)	Flat screwdriver Ø 3.5 mm Ø 0.138 in
	Flexible with insulated ferrule	0.5 ... 4 mm²	26 ... 12 AWG		
2 conductors per clamp	Flexible with twin ferrule	0.5 ... 1 mm²	26 ... 18 AWG		
Rated current / Rated cross section		30 A / 4 mm²	30 A / 10 AWG		
Rated short-time withstand current (1s)		480 A			
Rated voltage		1000 V	600 V		
Impulse withstand voltage		8000 V			
Protection		IP20	NEMA 1		

The connecting capacity data for one Rigid: Solid/Stranded, or one Flexible conductor (when applicable) is a mandatory information required by IEC, UL and CSA standards (Copper conductors). All other data are provided as supplementary information only. For more details, please consult our CB, UL or CSA certificates and technical datasheet available on <http://www.TE.com>



Mounting instructions



Accessories

Description	Color	Type	Part Number	Pkg qty	Weight (1 pce) g
1 Locking devices 9.4 mm 0.370 in spacing	Black <input checked="" type="checkbox"/>	VR-ZD	1SNK900637R0000	50	0.7
2 Cable Clamp 9.4 mm 0.370 in spacing	Dark grey <input checked="" type="checkbox"/>	PT-ZD	1SNK900660R0000	50	1.04
3 Terminal block markers	White <input type="checkbox"/>	MG-CPM 13 41791	1SNB041791R0612	1680	0.27
		MG-CPMFA 43196	1SNB043196R0012	350	2.56
		MC612	1SNK150000R0000	22	10.00
		MC612PA	1SNK159999R0000	20	11.00
	Universal wire markers holder	Grey <input type="checkbox"/>	UMH	1SNK900611R0000	10

Complete list of accessories is indicated in the terminal block datasheet including end stops. Some accessories such as jumper bars may modify the terminal block's ratings: Complete information available in the accessories section of the catalog.

Technical data valid for copper conductors only.

Screw clamp Pluggable

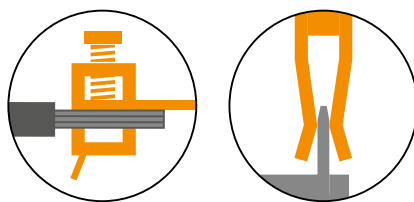

ZDS4-22 Screw clamp pluggable terminal blocks

Feed-through - 5.2 mm 0.205 in spacing

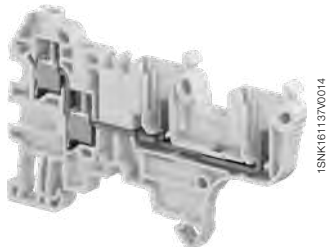

ZDS4-22

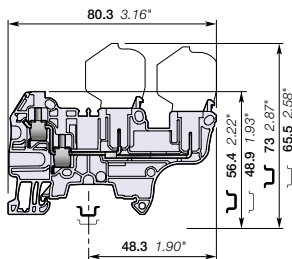

5.2 mm 0.205 in spacing

Description

- Increase your productivity with pluggable terminal blocks: possibility of pre-produced plugs harnesses, time saving plug and play assembly, reduced transportation panels preparation and final installation, easily connect sub-assemblies together,
- Simplify and secure your installation: in site faulty connection errors are eliminated, prior connection testing is eased and reliable, test connectors (TC5) withstanding 10 000 operations are compatible for convenient testing.

Ordering details

Description	Color	Type	Part Number	Pkg qty	Weight (1 pce) g
Feed-through 4 connections	Grey <input type="checkbox"/>	ZDS4-22	1SNK805013R0000	50	10.80

Main technical data

Connecting capacity		IEC	UL - CSA
1 conductor per clamp	Rigid: Solid/Stranded	0.2 ... 4 mm ²	24 ... 10 AWG
	Flexible without ferrule	0.22 ... 4 mm ²	24 ... 10 AWG
	Flexible with non insulated ferrule	0.22 ... 4 mm ²	24 ... 10 AWG
	Flexible with insulated ferrule	0.22 ... 2.5 mm ²	24 ... 12 AWG
	Gauge	A3-B3	
2 conductors per clamp	Rigid: Solid/Stranded	0.2 ... 1.5 mm ²	24 ... 16 AWG
	Flexible without ferrule	0.22 ... 1.5 mm ²	24 ... 16 AWG
	Flexible with twin ferrule	0.22 ... 1.5 mm ²	24 ... 16 AWG
Rated current / Rated cross section		29 A / 4 mm ²	28 A / 10 AWG
Rated short-time withstand current (1s)		480 A	
Rated voltage		800 V	300 V
Impulse withstand voltage		8000 V	
Protection		IP20	NEMA 1

Mounting instructions

Rail		TH 35-7.5, TH 35-15
Wire stripping length		10.5 mm 0.413 in
Tool		Flat screwdriver Ø 3.5 mm Ø 0.138 in
Torque		0.6 Nm ± 0.1 5.31 lb.in ± 0.885

The connecting capacity data for one Rigid: Solid/Stranded, or one Flexible conductor (when applicable) is a mandatory information required by IEC, UL and CSA standards (Copper conductors). All other data are provided as supplementary information only. For more details, please consult our CB, UL or CSA certificates and technical datasheet available on <http://www.TE.com>

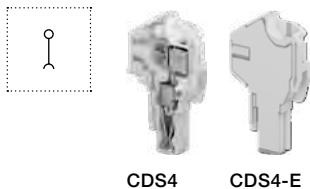
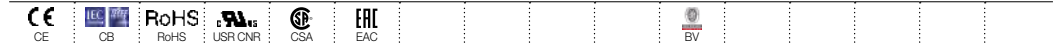

CDS4

CDS4-E

Female plugs

Description	Color	Type	Part Number	Pkg qty	Weight (1 pce) g
Female plugs 1 pole	Grey <input type="checkbox"/>	CDS4	1SNK805714R0000	50	3.90
Female plugs without outer nubs - Closed		CDS4-E	1SNK805715R0000	50	4.10

15 poles max.

Accessories

Description	Color	Type	Part Number	Pkg qty	Weight (1 pce) g	
1 End stops 10 mm 0.394 in	Dark grey <input type="checkbox"/>	BAM4	1SNK900001R0000	50	14.00	
2 End sections 0.8 mm 0.031 in	Dark grey <input type="checkbox"/>	EDS4-22	1SNK805911R0000	20	1.85	
3 Jumper bars	Orange <input type="checkbox"/>	2 poles 32 A (IEC)	JB5-2	1SNK905302R0000	50	1.30
		3 poles 32 A (IEC)	JB5-3	1SNK905303R0000	50	2.00
		4 poles 32 A (IEC)	JB5-4	1SNK905304R0000	50	2.70
		5 poles 32 A (IEC)	JB5-5	1SNK905305R0000	50	3.50
		10 poles 32 A (IEC)	JB5-10	1SNK905310R0000	30	7.10
50 poles 32 A (IEC)	JB5-50	1SNK905350R0000	10	36.00		
4 Circuit separators 3 mm 0.118 in	Dark grey <input type="checkbox"/>	CS-R3	1SNK900107R0000	20	6.40	
5 Test adapters	Dark grey <input type="checkbox"/>	For test plugs DIA 2 mm 0.079 in	TP2	1SNK900203R0000	20	1.70
		For test plugs DIA 4 mm 0.157 in	TP4	1SNK900205R0000	20	2.40
6 Test connectors 5.2 mm 0.205 in spacing	Dark grey <input type="checkbox"/>	End module, 5.2 mm 0.205 in	TC5	1SNK900200R0000	10	5.20
			TC5-R1	1SNK900201R0000	10	5.20
7 Coding pegs	Dark grey <input type="checkbox"/>	COP-ZD	1SNK900636R0000	10	3.57	
8 Terminal block markers	White <input type="checkbox"/>	Blank marker	MG-CPM 13 41790	1SNB041790R0512	1960	0.23
		Blank card	MC512	1SNK140000R0000	22	9.00
			MC512PA	1SNK149999R0000	20	10.00
		Universal wire markers holder	Grey <input type="checkbox"/>	UMH	1SNK900611R0000	10

Complete list of accessories is indicated in the terminal block datasheet including end stops.

Some accessories such as jumper bars may modify the terminal block's ratings: Complete information available in the accessories section of the catalog.

Technical data valid for copper conductors only.

CDS4 Screw clamp female plugs

Female plug - 5.2 mm 0.205 in spacing

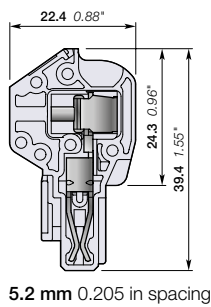
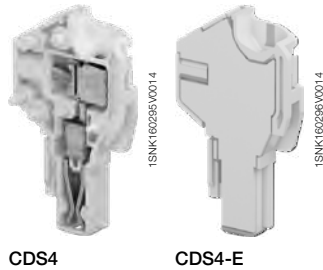

Description

- Create your own female plug assemblies without any special tools, easily snap together multiple plugs for optimal ergonomics and quick assembly,
- Increase your flexibility: eliminate stock of pre-configured female plugs, easily add an extra plug in case of needed modification,
- Reduce your stock of unitary plugs up to 30%: only two plug variants are required to compose your own subsets of plugs from 2 to 15 poles.

Ordering details

Description	Color	Type	Part Number	Pkg qty	Weight (1 pce) g
Female plugs	Grey <input type="checkbox"/>	CDS4	1SNK805714R0000	50	3.90
Female plugs without outer nubs - Closed		CDS4-E	1SNK805715R0000	50	4.10

Main technical data

Connecting capacity		IEC	UL - CSA	Mounting instructions	
1 conductor per clamp	Rigid: Solid/Stranded	0.2 ... 4 mm ²	24 ... 10 AWG	Rail	
	Flexible without ferrule	0.22 ... 4 mm ²		Wire stripping length	10.5 mm 0.413 in
	Flexible with non insulated ferrule	0.22 ... 4 mm ²	24 ... 10 AWG		
	Flexible with insulated ferrule	0.22 ... 2.5 mm ²	24 ... 12 AWG		
	Gauge	A3-B3			
2 conductors per clamp	Rigid: Solid/Stranded	0.2 ... 1.5 mm ²	24 ... 16 AWG	Tool	Flat screwdriver Ø 3.5 mm Ø 0.138 in
	Flexible without ferrule	0.22 ... 1.5 mm ²			
	Flexible with twin ferrule	0.22 ... 1.5 mm ²	24 ... 16 AWG		
Rated current / Rated cross section		29 A / 4 mm ²	28 A / 10 AWG	Torque	0.6 Nm ± 0.1 5.31 lb.in ± 0.885
Rated short-time withstand current (1s)		480 A			
Rated voltage		800 V	300 V		
Impulse withstand voltage		8000 V			
Protection		IP20	NEMA 1		

The connecting capacity data for one Rigid: Solid/Stranded, or one Flexible conductor (when applicable) is a mandatory information required by IEC, UL and CSA standards (Copper conductors). All other data are provided as supplementary information only. For more details, please consult our CB, UL or CSA certificates and technical datasheet available on <http://www.TE.com>

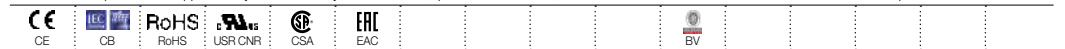

Mounting instructions



Accessories

Description	Color	Type	Part Number	Pkg qty	Weight (1 pce) g
1 Locking devices	Black <input checked="" type="checkbox"/>	VR-ZD	1SNK900637R0000	50	0.7
2 Cable Clamp	Dark grey <input checked="" type="checkbox"/>	PT-ZD	1SNK900660R0000	50	1.04
3 Terminal block markers	White <input type="checkbox"/>	MG-CPM 13 41790	1SNB041790R0512	1960	0.23
		MG-CPMFA 43196	1SNB043196R0012	350	2.56
		MC512	1SNK140000R0000	22	9.00
		MC512PA	1SNK149999R0000	20	10.00
	Universal wire markers holder	Grey <input type="checkbox"/>	UMH	1SNK900611R0000	10

Complete list of accessories is indicated in the terminal block datasheet including end stops. Some accessories such as jumper bars may modify the terminal block's ratings: Complete information available in the accessories section of the catalog.

Technical data valid for copper conductors only.

ZDS4-22-R1 Screw clamp pluggable terminal blocks

Feed-through - 6 mm 0.236 in spacing

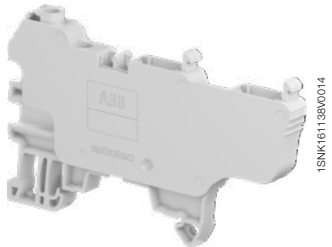

ZDS4-22-R1

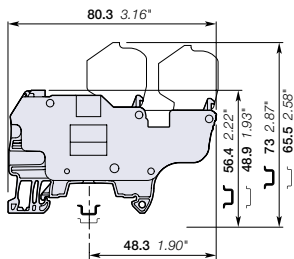

6 mm 0.236 in spacing

Description

- Increase your productivity with pluggable terminal blocks: possibility of pre-produced plugs harnesses, time saving plug and play assembly, reduced transportation panels preparation and final installation, easily connect sub-assemblies together,
- Simplify and secure your installation: in site faulty connection errors are eliminated, prior connection testing is eased and reliable, test connectors (TC5-R1 + ES-TC6) withstanding 10 000 operations are compatible for convenient testing.

Ordering details

Description	Color	Type	Part Number	Pkg qty	Weight (1 pce) g
Feed-through 4 connections	Grey <input type="checkbox"/>	ZDS4-22-R1	1SNK806013R0000	40	12.60

Main technical data

Connecting capacity		IEC	UL - CSA
1 conductor per clamp	Rigid: Solid/Stranded	0.2 ... 4 mm²	24 ... 10 AWG
	Flexible without ferrule	0.22 ... 4 mm²	24 ... 10 AWG
	Flexible with non insulated ferrule	0.22 ... 4 mm²	24 ... 10 AWG
	Flexible with insulated ferrule	0.22 ... 4 mm²	24 ... 10 AWG
	Gauge	A3-B3	
2 conductors per clamp	Rigid: Solid/Stranded	0.2 ... 1.5 mm²	24 ... 16 AWG
	Flexible without ferrule	0.22 ... 1.5 mm²	24 ... 16 AWG
	Flexible with twin ferrule	0.22 ... 1.5 mm²	24 ... 16 AWG
Rated current / Rated cross section		29 A / 4 mm²	28 A / 10 AWG
Rated short-time withstand current (1s)		480 A	
Rated voltage		800 V	300 V
Impulse withstand voltage		8000 V	
Protection		IP20	NEMA 1

Mounting instructions

Rail		TH 35-7.5, TH 35-15
Wire stripping length		10.5 mm 0.413 in
Tool		Flat screwdriver Ø 3.5 mm Ø 0.138 in
Torque		0.6 Nm ± 0.1 5.31 lb.in ± 0.885

The connecting capacity data for one Rigid: Solid/Stranded, or one Flexible conductor (when applicable) is a mandatory information required by IEC, UL and CSA standards (Copper conductors). All other data are provided as supplementary information only. For more details, please consult our CB, UL or CSA certificates and technical datasheet available on <http://www.TE.com>

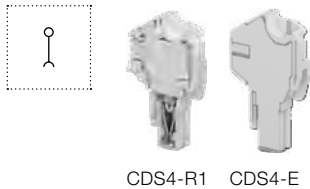
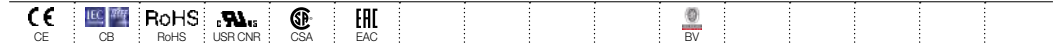

CDS4-R1 CDS4-E

Female plugs

Description	Color	Type	Part Number	Pkg qty	Weight (1 pce) g
Female plugs 1 pole	Grey <input type="checkbox"/>	CDS4-R1	1SNK806714R0000	50	4.10
Female plugs without outer nubs - Closed		CDS4-E	1SNK805715R0000	50	4.10

15 poles max.

Accessories

Description	Color	Type	Part Number	Pkg qty	Weight (1 pce) g	
1 End stops 10 mm 0.394 in	Dark grey <input type="checkbox"/>	BAM4	1SNK900001R0000	50	14.00	
2 Jumper bars	Orange <input type="checkbox"/>	2 poles 41 A (IEC)	JB6-2	1SNK906302R0000	50	1.30
		3 poles 41 A (IEC)	JB6-3	1SNK906303R0000	50	2.10
		4 poles 41 A (IEC)	JB6-4	1SNK906304R0000	50	2.90
		5 poles 41 A (IEC)	JB6-5	1SNK906305R0000	50	3.60
		10 poles 41 A (IEC)	JB6-10	1SNK906310R0000	20	7.40
50 poles 41 A (IEC)	JB6-50	1SNK906350R0000	10	38.10		
3 Circuit separators 3 mm 0.118 in	Dark grey <input type="checkbox"/>	CS-R3	1SNK900107R0000	20	6.40	
4 Test adapters	Dark grey <input type="checkbox"/>	TP2	1SNK900203R0000	20	1.70	
	Dark grey <input type="checkbox"/>	TP4	1SNK900205R0000	20	2.40	
5 Test connectors End module, 5.2 mm 0.205 in	Dark grey <input type="checkbox"/>	TC5-R1	1SNK900201R0000	10	5.20	
6 Spacers 0.8 mm 0.031 in	Dark grey <input type="checkbox"/>	ES-TC6	1SNK900105R0000	10	0.80	
7 Coding pegs	Dark grey <input type="checkbox"/>	COP-ZD	1SNK900636R0000	10	3.57	
8 Terminal block markers	White <input type="checkbox"/>	Blank marker	MG-CPM 13 41791	1SNB041791R0612	1680	0.27
		Blank card	MC612	1SNK150000R0000	22	10.00
		Universal wire markers holder	MC612PA	1SNK159999R0000	20	11.00
	Grey <input type="checkbox"/>	UMH	1SNK900611R0000	10	0.20	

Complete list of accessories is indicated in the terminal block datasheet including end stops.

Some accessories such as jumper bars may modify the terminal block's ratings: Complete information available in the accessories section of the catalog.

Technical data valid for copper conductors only.

CDS4-R1 Screw clamp female plugs

Female plug - 6 mm 0.236 in spacing

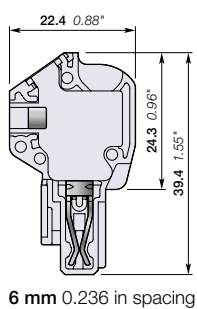
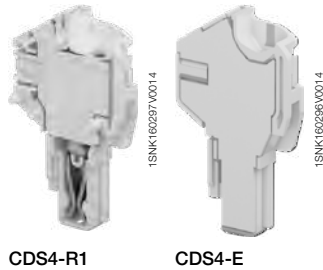

Description

- Create your own female plug assemblies without any special tools, easily snap together multiple plugs for optimal ergonomics and quick assembly,
- Increase your flexibility: eliminate stock of pre-configured female plugs, easily add an extra plug in case of needed modification,
- Reduce your stock of unitary plugs up to 30%: only two plug variants are required to compose your own subsets of plugs from 2 to 15 poles.

Ordering details

Description	Color	Type	Part Number	Pkg qty	Weight (1 pce) g
Female plugs	Grey <input type="checkbox"/>	CDS4-R1	1SNK806714R0000	50	4.10
Female plugs without outer nubs - Closed		CDS4-E	1SNK805715R0000	50	4.10

Main technical data

Connecting capacity		IEC	UL - CSA	Mounting instructions	
1 conductor per clamp	Rigid: Solid/Stranded	0.2 ... 4 mm ²	24 ... 10 AWG	Rail	
	Flexible without ferrule	0.22 ... 4 mm ²		Wire stripping length	10.5 mm 0.413 in
	Flexible with non insulated ferrule	0.22 ... 4 mm ²	24 ... 10 AWG		
	Flexible with insulated ferrule	0.22 ... 4 mm ²	24 ... 10 AWG		
	Gauge	A3-B3			
2 conductors per clamp	Rigid: Solid/Stranded	0.2 ... 1.5 mm ²	24 ... 16 AWG	Tool	Flat screwdriver Ø 3.5 mm Ø 0.138 in
	Flexible without ferrule	0.22 ... 1.5 mm ²			
	Flexible with twin ferrule	0.22 ... 1.5 mm ²	24 ... 16 AWG		
Rated current / Rated cross section		29 A / 4 mm ²	28 A / 10 AWG	Torque	0.6 Nm ± 0.1 5.31 lb.in ± 0.885
Rated short-time withstand current (1s)		480 A			
Rated voltage		800 V	300 V		
Impulse withstand voltage		8000 V			
Protection		IP20	NEMA 1		

The connecting capacity data for one Rigid: Solid/Stranded, or one Flexible conductor (when applicable) is a mandatory information required by IEC, UL and CSA standards (Copper conductors). All other data are provided as supplementary information only. For more details, please consult our CB, UL or CSA certificates and technical datasheet available on <http://www.TE.com>

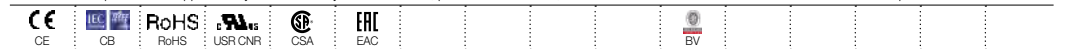

Mounting instructions



Accessories

Description	Color	Type	Part Number	Pkg qty	Weight (1 pce) g
1 Locking devices	Black <input checked="" type="checkbox"/>	VR-ZD	1SNK900637R0000	50	0.7
2 Cable Clamp	Dark grey <input checked="" type="checkbox"/>	PT-ZD	1SNK900660R0000	50	1.04
3 Terminal block markers	White <input type="checkbox"/>	MG-CPM 13 41791	1SNB041791R0612	1680	0.27
		MG-CPMFA 43196	1SNB043196R0012	350	2.56
		MC612	1SNK150000R0000	22	10.00
		MC612PA	1SNK159999R0000	20	11.00
	Universal wire markers holder	Grey <input type="checkbox"/>	UMH	1SNK900611R0000	10

Complete list of accessories is indicated in the terminal block datasheet including end stops. Some accessories such as jumper bars may modify the terminal block's ratings: Complete information available in the accessories section of the catalog.

Technical data valid for copper conductors only.

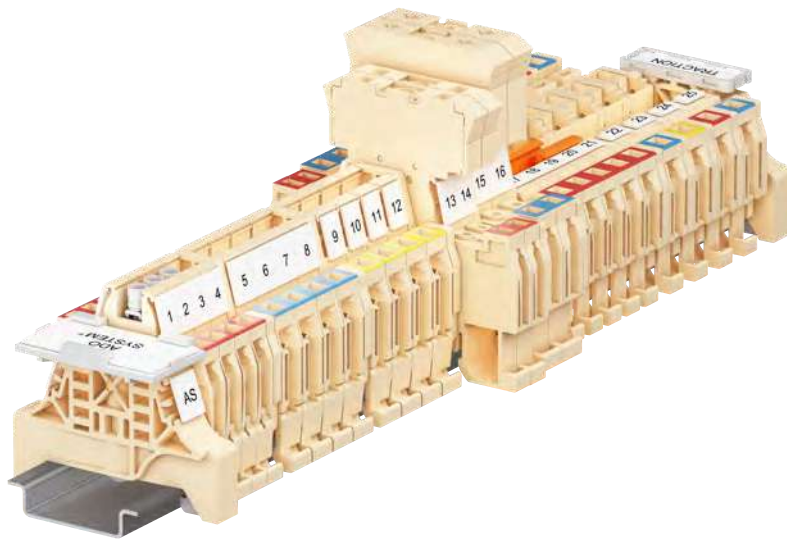

Railway applications, terminal blocks

ADO System® IDC and pluggable technologies

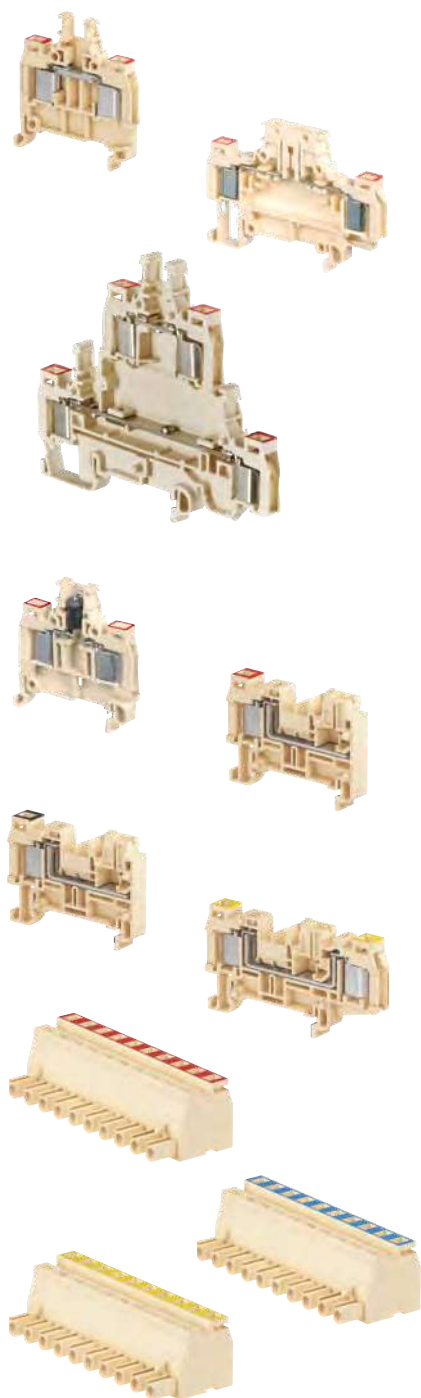

Technologies presentation		104	
Overview		106	
Feed-through			
1.5 mm ²	D1.5/5.ADO.NF	110	
1.82 mm ²	D1.5/6.ADO.NF	111	
2.61 mm ²	D2.5/8.ADO.NF	112	
1.5 mm ²	D2.5/8.ADO.NF1	113	
4.32 mm ²	D4/8.ADO.NF	114	
Disconnect with plug			
1.82 mm ²	D1.5/6.S.ADO.NF	115	
2.61 mm ²	D2.5/8.S.ADO.NF	116	
Double deck			
1.82 mm ²	D1.5/6.D2.ADO.NF	117	
Component holder			
1.82 mm ²	D1.5/6.ADO.D2.NF	118	
Pluggable			
1.82 mm ²	D1.5/7.ADO-CPE.NF	1x ADO system - 1x pluggable	119
1.5 mm ²	D2.5/7.ADO-CPE.NF1	1x ADO system - 1x pluggable	120
1.82 mm ²	D1.5/7.2ADO-CPE.NF	2x ADO system - 1x pluggable	121
2.61 mm ²	D2.5/7.ADO-CPE.NF	1x ADO system - 1x pluggable	122
	D2.5/7.2ADO-CPE.NF	2x ADO system - 1x pluggable	123
4.32 mm ²	D4/7.ADO-CPE.NF	1x ADO system - 1x pluggable	124
	D4/7.2ADO-CPE.NF	2x ADO system - 1x pluggable	125
	D2.5/7.2CPE	1x pluggable - 1x pluggable	126
	D2.5/7.2CPE.CPE	1x pluggable - 1x pluggable	127
Female plugs			
1.82 mm ²	L 266 200 15	2 to 10 poles	128
	L 266 200 25	2 to 10 poles-with brackets	129
	L 277 200 15	2 to 6 poles	130
2.61 mm ²	L 267 200 15	2 to 10 poles	131
	L 267 200 25	2 to 10 poles	132
4.32 mm ²	L 276 200 15	4 and 5 poles	133
Male plugs			
1.82 mm ²	L 366 200 45	2 to 10 poles	134
2.61 mm ²	L 367 200 45	2 to 10 poles	135

Railway applications, terminal blocks

ADO System® IDC and pluggable technologies

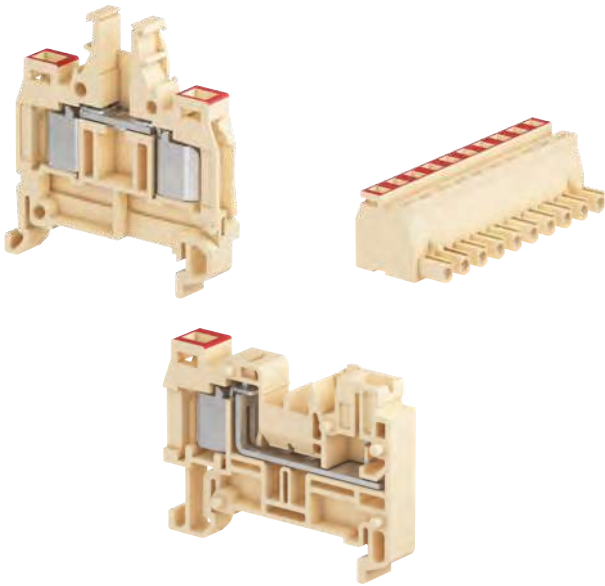

The fastest connection technology for rolling stock

The ADO system® technology based on insulation displacement (IDC) technology offers significant productivity savings as well as secure and reliable connection in case of vibration and shock.

Combined with the pluggable technology, it increases the productivity thanks to pre-produced plugs harnesses.



4



Reliable in harsh conditions

Continuous operation guaranteed for rolling stock

- Environmental tests: aging, corrosion, flammability, toxicity (I2F2, V0, HL3 R22)
- Mechanical tests: vibration and shock.



Cost effective solution

80% wiring time reduced compared to traditional technologies

- Asymmetrical design avoid mounting and wiring errors.
- Zero-retightening with our technologies.



Improve installation efficiency

Connection process simplified and secured

- Tool locked during the connection process
- Optimized wiring with pluggable technology
- Up to 2 conductors per ADO clamp.

Features

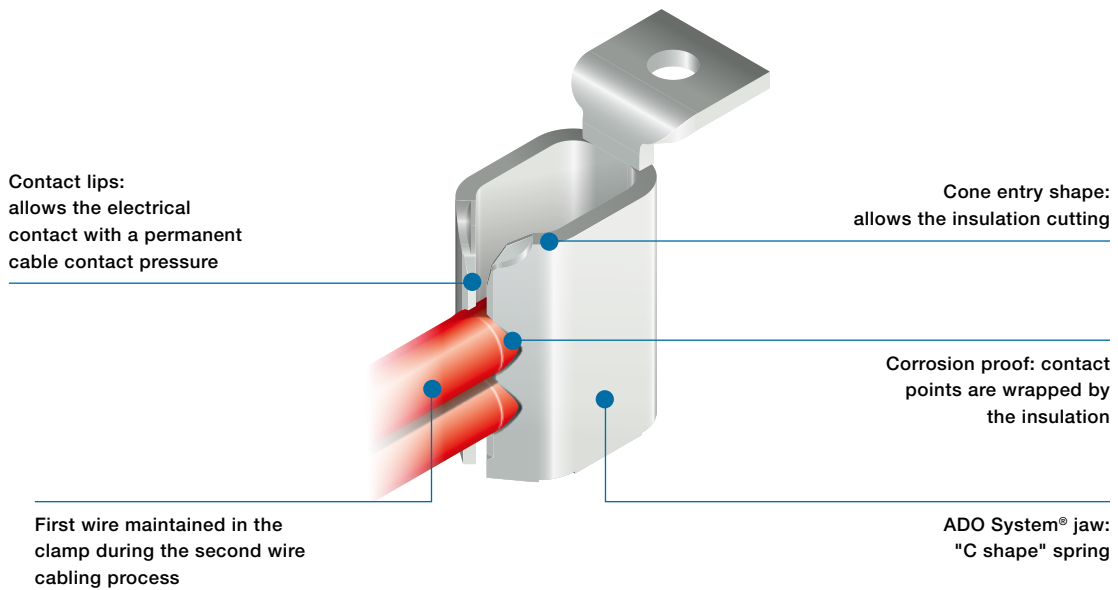
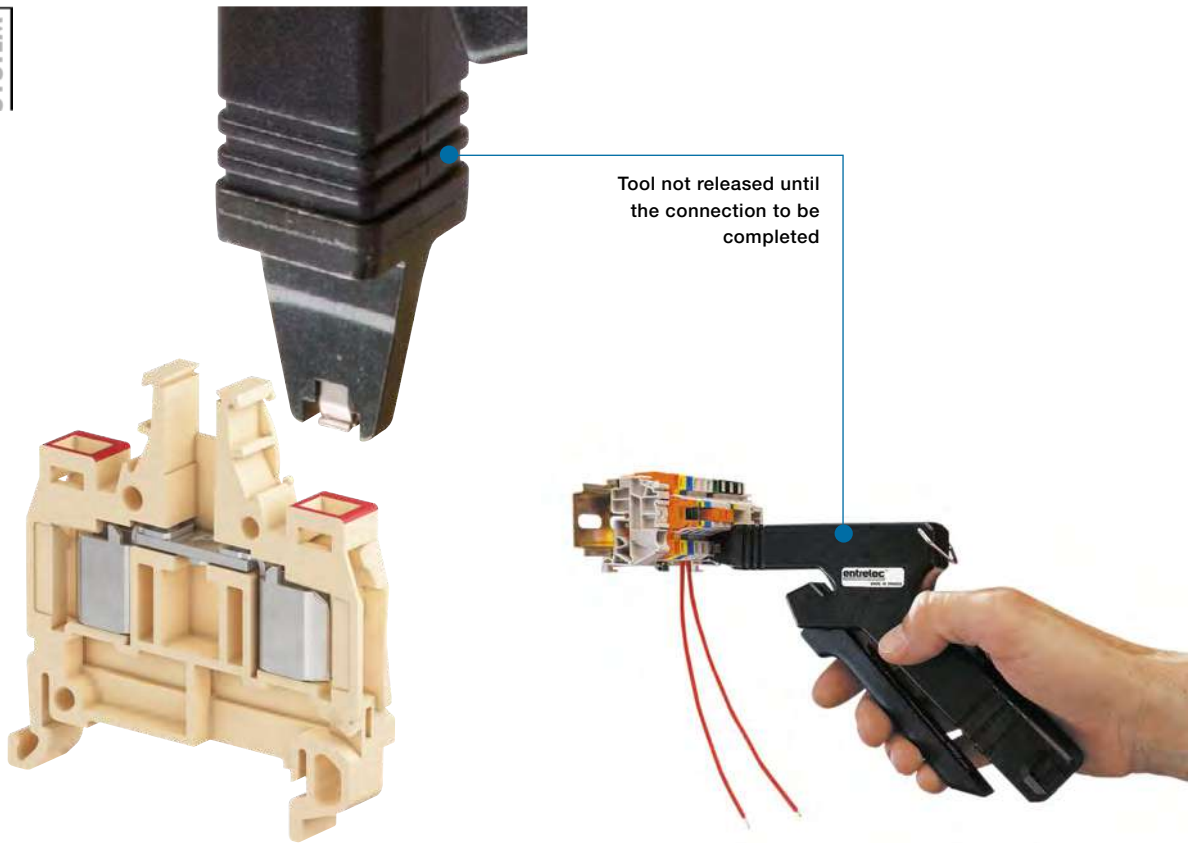

Railway applications, terminal blocks

ADO System® IDC and pluggable technologies

Range overview from 1.5 mm² up to 4 mm² - 16 AWG up to 12 AWG

Feed-through

Red = 1.5 mm² / 16 AWG

Blue = 2.5 mm² / 14 AWG

Yellow = 4 mm² / 12 AWG

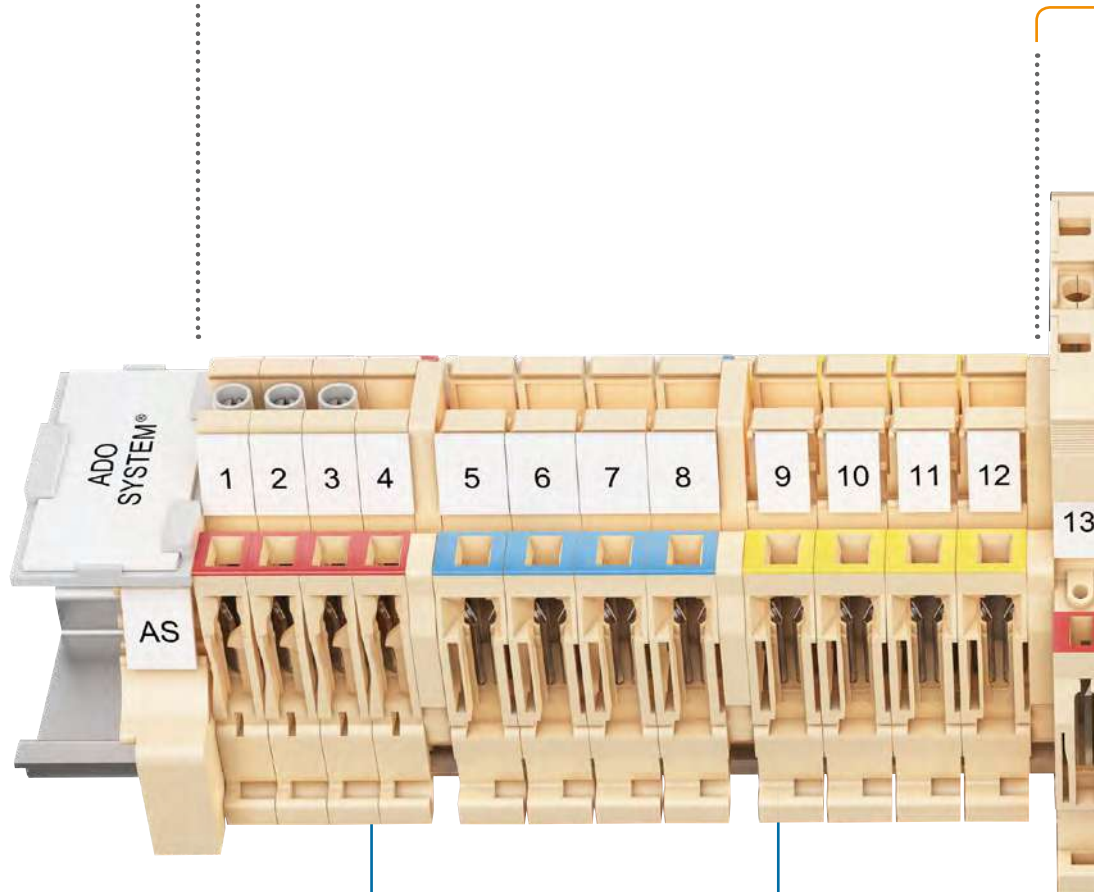

Specific color marking
Easy identification of the wire size

Connection of up to 2 wires
Save space by connecting
up to 2 conductors in 1 connection

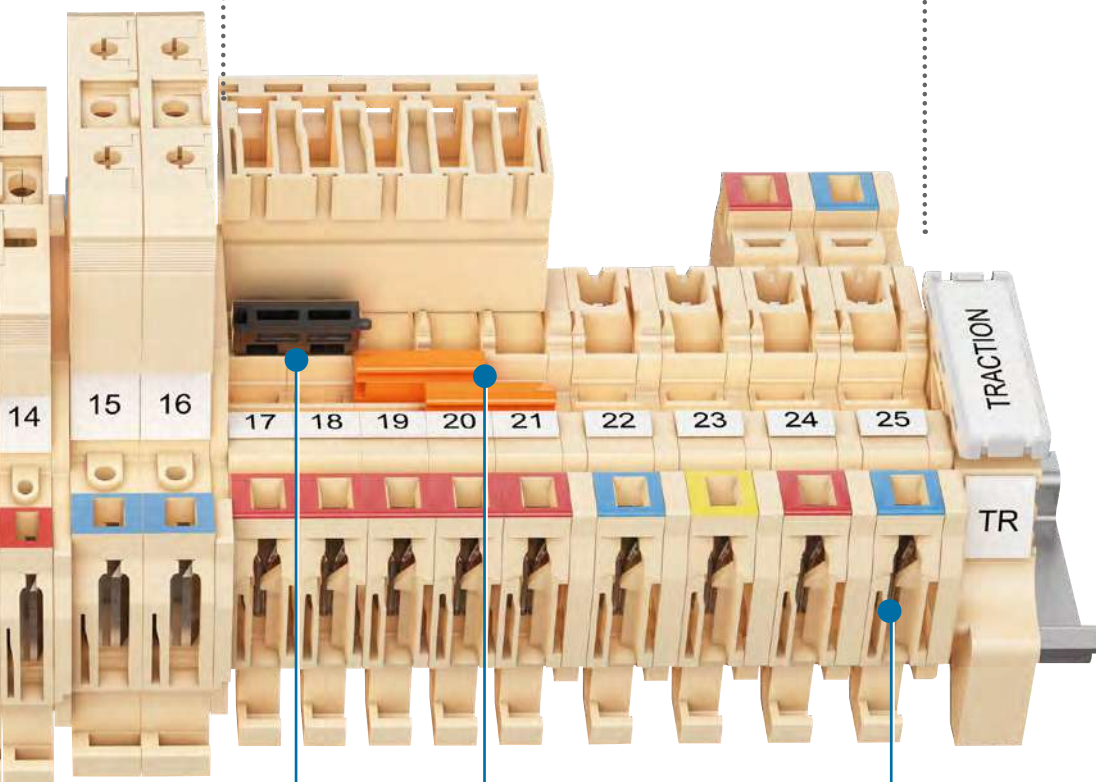
Component holder1.5 mm² / 16 AWG**Disconnect with plug**1.5 and 2.5 mm²
16 and 14 AWG**Pluggable**From 1.5 to 4 mm²
From 16 to 12 AWG**Locking lever**Secure against
accidental wire pulling**Double jumper channel**Plug-in insulated
jumpers**EN 50306 compatibility**The clamps are compatible
with thin insulated conductors



Railway applications, terminal blocks

ADO System® IDC and pluggable technologies



Feed-through

Section					
1.5 mm ²	D1.5/5.ADO.NF	D2.5/8.ADO.NF1	D1.5/6.ADO.NF	D2.5/8.ADO.NF	D4/8.ADO.NF
1.82 mm ²					
2.61 mm ²					
4.32 mm ²					



Pluggable

Feed-through: 1 ADO - 1 pluggable

Section				
1.5 mm ²	D1.5/7.ADO-CPE.NF	D2.5/7.ADO-CPE.NF1	D2.5/7.ADO-CPE.NF	D4/7.ADO-CPE.NF
1.82 mm ²				
2.61 mm ²				
4.32 mm ²				



Female plugs for pluggable terminal blocks

Section				
1.5 mm ²	L 266 200 15	L 266 200 25	L 277 200 15	L 276 200 15
1.82 mm ²			L 267 200 15	L 267 200 25
2.61 mm ²				
4.32 mm ²				

Clamp -
 Channels for jumpering or testing -
 Test socket -
 Blown-fuse indicator

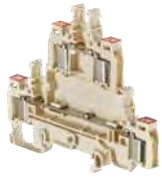

Double deck



D1.5/6.D2.ADO.NF

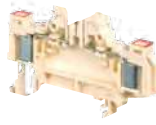

Disconnect with plug



D1.5/6.S.ADO.NF



D2.5/8.S.ADO.NF



Component holder



D1.5/6.ADO.D2.NF

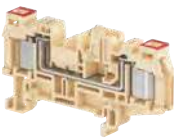

Feed-through: 2 ADO - 1 pluggable



D1.5/7.2ADO-CPE.NF

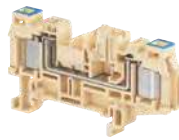

D2.5/7.2ADO-CPE.NF

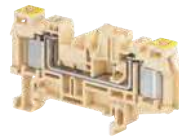

D4/7.2ADO-CPE.NF

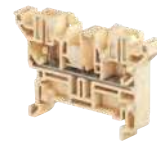

Feed-through: 2 pluggables



D2.5/7.2CPE
D2.5/7.2CPE
D2.5/7.2CPE
D2.5/7.2CPE

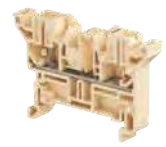

D2.5/7.CPE.CPE
D2.5/7.CPE.CPE
D2.5/7.CPE.CPE
D2.5/7.CPE.CPE



Male plugs



L 366 200 45



L 367 200 45

D1.5/5.ADO.NF IDC terminal blocks

Feed-through - ADO System® - 5 mm 0.197 in spacing

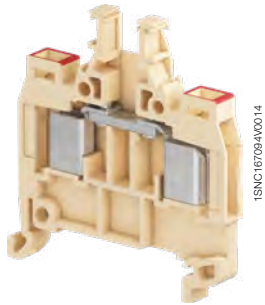

D1.5/5.ADO.NF

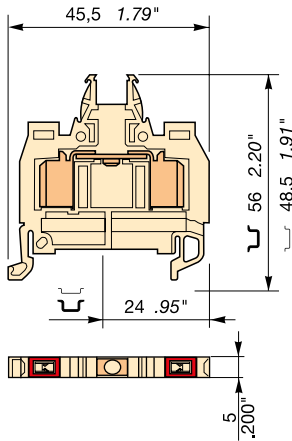

5 mm 0.197 in spacing

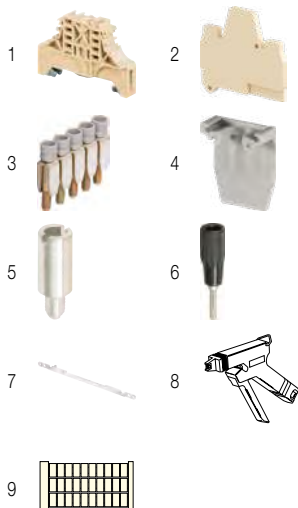

Description

- With the TE Connectivity ADO System®, experience the fastest and most reliable connection on the market,
- Designed for rolling stock applications exposed to severe constraints (vibrations, shocks etc.),
- Up to 2 wires per connection,
- Red marking to identify wire size.

Ordering details

Description	Color	Type	Part Numbers	Pkg qty	Weight (1 pce)
Feed-through	Beige <input type="checkbox"/>	D1.5/5.ADO.NF	1SNA400315R0100	50	5.00

Main technical data

Connecting capacity	NF F 63-808	NF F 63-296 NF F 63-826	EN 50306
ADO Flexible without ferrule	0.6 ... 1.34 mm²		0.5 ... 1.5 mm²
Rated current	17.5 A	16 A	
Rated short-time withstand current (1s)	180 A		
Rated voltage	1000 V	500 V	
Impulse withstand voltage	8000 V		
Protection	IP20		

Mounting instructions

Rail	TH 35-7.5, TH 35-15
Tool	ADO system tool

CE	RoHS	EAC
----	------	-----

Accessories

Description	Color	Type	Part Numbers	Pkg qty	Weight (1 pce)
1 End stops	Beige <input type="checkbox"/>	BAM2	1SNA296351R0000	50	12.00
2 End sections	Beige <input type="checkbox"/>	FEMAD3	1SNA399802R0500	20	2.50
3 Jumper bars		BJMI5-2	1SNA176278R1600	10	3.30
		BJMI5-3	1SNA176279R1700	10	5.00
		BJMI5-4	1SNA176280R0500	10	6.70
		BJMI5-5	1SNA176281R2200	10	8.40
		BJMI5-10	1SNA176282R2300	10	16.90
4 Circuit separators	Grey <input type="checkbox"/>	SCAD5	1SNA199551R2000	10	0.30
5 Test sockets		AL2	1SNA163043R2100	50	0.90
		AL3	1SNA163261R0000	50	1.20
		FC2	1SNA007865R2600	100	2.00
6 Test plugs		CBM5	1SNA178745R1400	50	1
		CBM8	1SNA178746R1500	50	1
		OUPAD	1SNA178944R0400	1	205.00
7 Shield connectors		OUMAD	1SNA179466R0600	1	29.00
		RC55	1SNA231000R0700	10	5.20
		RC55	1SNA230000R1200	10	2.90
8 Tools		Semi automatic tool			
		Hand tool			
9 Terminal block markers		Blank card			

D1.5/6.ADO.NF IDC terminal blocks

Feed-through - ADO System® - 6 mm 0.236 in spacing

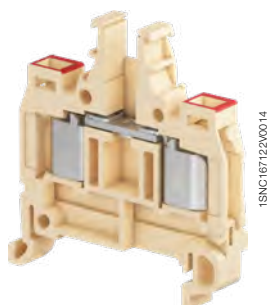

D1.5/6.ADO.NF

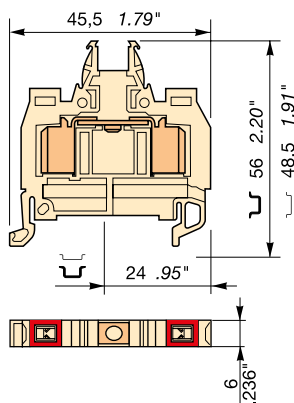

6 mm 0.236 in spacing

Description

- With the TE Connectivity ADO System®, experience the fastest and most reliable connection on the market,
- Designed for rolling stock applications exposed to severe constraints (vibrations, shocks etc.),
- Up to 2 wires per connection,
- Red marking to identify wire size.

Ordering details

Description	Color	Type	Part Numbers	Pkg qty	Weight (1 pce)
Feed-through	Beige	D1.5/6.ADO.NF	1SNA399730R1700	50	6.00

Main technical data

Connecting capacity	NF F 63-808	NF F 63-296 NF F 63-826	EN 50306	Rail	TH 35-7.5, TH 35-15
ADO Flexible without ferrule	0.6 ... 1.82 mm²	0.5 ... 1.5 mm²		Tool	ADO system tool
Rated current	17.5 A	16 A			
Rated short-time withstand current (1s)	180 A				
Rated voltage	1000 V	500 V			
Impulse withstand voltage	8000 V				
Protection	IP20				

Mounting instructions

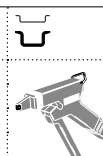

CE	RoHS	EAC			
CE	RoHS	EAC			



Accessories

Description	Color	Type	Part Numbers	Pkg qty	Weight (1 pce)
1 End stops	Beige	BAM2	1SNA296351R0000	50	12.00
2 End sections	Beige	FEMAD3	1SNA399802R0500	20	2.50
3 Jumper bars		BJMI6-2	1SNA176663R0000	10	4.40
		BJMI6-3	1SNA176664R0100	10	6.70
		BJMI6-4	1SNA176665R0200	10	8.90
		BJMI6-5	1SNA176666R0300	10	11.20
		BJMI6-10	1SNA176667R0400	10	22.40
		BJS6-20	1SNA174784R2000	10	26.70
4 Cross spacing jumpers		EL6	1SNA173627R2100	10	0.10
5 Circuit separators	Grey	SCAD	1SNA196896R0000	10	0.7
6 Test sockets		AL2	1SNA163043R2100	50	0.90
		AL3	1SNA163261R0000	50	1.20
7 Test plugs	Black	FC2	1SNA007865R2600	100	2.00
8 Shield connectors		CBM5	1SNA178745R1400	50	1
		CBM8	1SNA178746R1500	50	1
		OUPAD	1SNA178944R0400	1	205.00
9 Tools		OUMAD	1SNA179466R0600	1	29.00
		RC610	1SNA233000R0100	10	7.50
10 Terminal block markers		RC65	1SNA232000R0000	10	3.60

D2.5/8.ADO.NF IDC terminal blocks

Feed-through - ADO System® - 8 mm 0.315 in spacing

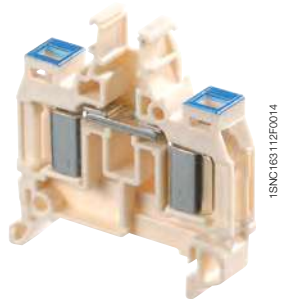

D2.5/8.ADO.NF

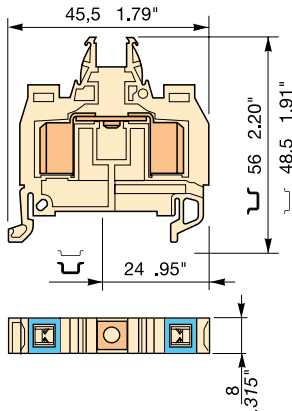

8 mm 0.315 in spacing



Description

- With the TE Connectivity ADO System®, experience the fastest and most reliable connection on the market,
- Designed for rolling stock applications exposed to severe constraints (vibrations, shocks etc.),
- Up to 2 wires per connection,
- Blue marking to identify wire size.

Ordering details

Description	Color	Type	Part Numbers	Pkg qty	Weight (1 pce) g
Feed-through	Beige	D2.5/8.ADO.NF	1SNA399736R0100	50	9.00

Main technical data

Connecting capacity	NF F 63-808	NF F 63-296 NF F 63-826	EN 50306
ADO Flexible without ferrule	0.93 ... 2.61 mm²	1 ... 2.5 mm²	
Rated current	24 A	16 A	
Rated short-time withstand current (1s)	300 A		
Rated voltage	1000 V	500 V	
Impulse withstand voltage	8000 V		
Protection	IP20		

Mounting instructions

Rail	TH 35-7.5, TH 35-15
Tool	ADO system tool

CE	RoHS	EAC																	
----	------	-----	--	--	--	--	--	--	--	--	--	--	--	--	--	--	--	--	--

Accessories

Description	Color	Type	Part Numbers	Pkg qty	Weight (1 pce) g
1 End stops	Beige	BAM2	1SNA296351R0000	50	12.00
2 End sections	Beige	FEMAD3	1SNA399802R0500	20	2.50
3 Jumper bars		BJMI8-2	1SNA176669R1600	10	4.50
		BJMI8-3	1SNA176670R1300	10	6.00
		BJMI8-4	1SNA176671R0000	10	10.00
		BJMI8-5	1SNA176672R0100	10	12.20
		BJMI8-10	1SNA176673R0200	10	20.00
4 Cross spacing jumpers		EL6	1SNA173627R2100	10	0.10
5 Circuit separators	Grey	SCAD	1SNA196896R0000	10	0.7
6 Test sockets		AL2	1SNA163043R2100	50	0.90
		AL3	1SNA163261R0000	50	1.20
		FC2	1SNA007865R2600	100	2.00
7 Test plugs	Black	FC4	1SNA167860R0100	10	10.00
	White	OUPAD	1SNA178944R0400	1	205.00
8 Tools		OUMAD	1SNA179466R0600	1	29.00
		RC810	1SNA234000R0200	10	8.20
9 Terminal block markers					

D2.5/8.ADO.NF1 IDC terminal blocks

Feed-through - ADO System® - 8 mm 0.315 in spacing

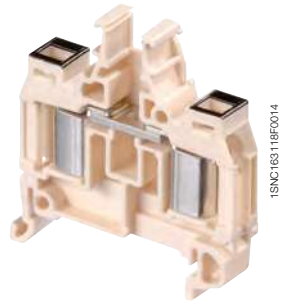

D2.5/8.ADO.NF1

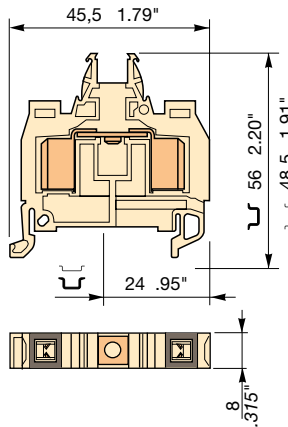

8 mm 0.315 in spacing



Description

- With the TE Connectivity ADO System®, experience the fastest and most reliable connection on the market,
- Designed for rolling stock applications exposed to severe constraints (vibrations, shocks etc.),
- Up to 2 wires per connection,
- Black marking to identify wire size.

Ordering details

Description	Color	Type	Part Numbers	Pkg qty	Weight (1 pce) g
Feed-through	Beige <input type="checkbox"/>	D2.5/8.ADO.NF1	1SNA399749R2600	50	9.00

Main technical data

Connecting capacity	NF F 63-808	NF F 63-296 NF F 63-826	EN 50306	Rail	TH 35-7.5, TH 35-15
ADO Flexible without ferrule		1.5 mm²		Tool	ADO system tool
Rated current	24 A	16 A			
Rated short-time withstand current (1s)	180 A				
Rated voltage	1000 V	500 V			
Impulse withstand voltage	8000 V				
Protection	IP20				

Mounting instructions

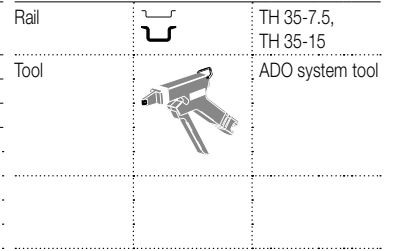

--	--	--	--	--	--

Accessories

Description	Color	Type	Part Numbers	Pkg qty	Weight (1 pce) g
1 End stops	Beige <input type="checkbox"/>	BAM2	1SNA296351R0000	50	12.00
2 End sections	Beige <input type="checkbox"/>	FEMAD3	1SNA399802R0500	20	2.50
3 Jumper bars		BJMI8-2	1SNA176669R1600	10	4.50
		BJMI8-3	1SNA176670R1300	10	6.00
		BJMI8-4	1SNA176671R0000	10	10.00
		BJMI8-5	1SNA176672R0100	10	12.20
		BJMI8-10	1SNA176673R0200	10	20.00
4 Cross spacing jumpers		EL6	1SNA173627R2100	10	0.10
5 Circuit separators	Grey <input type="checkbox"/>	SCAD	1SNA196896R0000	10	0.7
6 Test sockets		AL2	1SNA163043R2100	50	0.90
		AL3	1SNA163261R0000	50	1.20
7 Test plugs	Black <input type="checkbox"/>	FC2	1SNA007865R2600	100	2.00
	White <input type="checkbox"/>	FC4	1SNA167860R0100	10	10.00
8 Tools		OUPAD	1SNA178944R0400	1	205.00
		OUMAD	1SNA179466R0600	1	29.00
9 Terminal block markers	White <input type="checkbox"/>	RC810	1SNA234000R0200	10	8.20

D4/8.ADO.NF IDC terminal blocks

Feed-through - ADO System® - 8 mm 0.315 in spacing



4.32 mm²

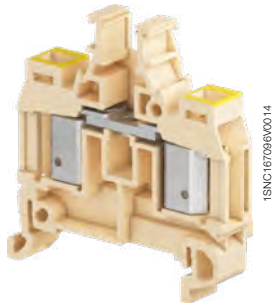

1SNC167096X0014

D4/8.ADO.NF

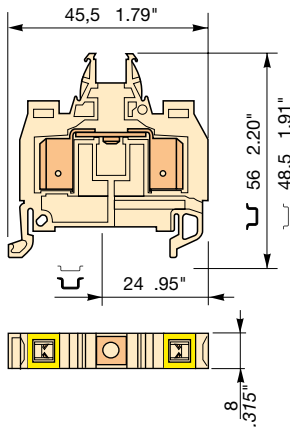

8 mm 0.315 in spacing



Description

- With the TE Connectivity ADO System®, experience the fastest and most reliable connection on the market,
- Designed for rolling stock applications exposed to severe constraints (vibrations, shocks etc.),
- Up to 2 wires per connection,
- Yellow marking to identify wire size.

Ordering details

Description	Color	Type	Part Numbers	Pkg qty	Weight (1 pce) g
Feed-through	Beige <input type="checkbox"/>	D4/8.ADO.NF	1SNA399748R2500	50	9.00

Main technical data

Connecting capacity	NF F 63-808	NF F 63-296 NF F 63-826	EN 50306
ADO Flexible without ferrule	4.32 mm²		
Rated current	32 A	16 A	
Rated short-time withstand current (1s)	480 A		
Rated voltage	1000 V	500 V	
Impulse withstand voltage	8000 V		
Protection	IP20		

Mounting instructions

Rail		TH 35-7.5, TH 35-15
Tool		ADO system tool

--	--	--	--	--	--	--	--	--	--

Accessories

Description	Color	Type	Part Numbers	Pkg qty	Weight (1 pce) g
1 End stops	Beige <input type="checkbox"/>	BAM2	1SNA296351R0000	50	12.00
2 End sections	Beige <input type="checkbox"/>	FEMAD3	1SNA399802R0500	20	2.50
3 Jumper bars		BJMI8-2	1SNA176669R1600	10	4.50
		BJMI8-3	1SNA176670R1300	10	6.00
		BJMI8-4	1SNA176671R0000	10	10.00
		BJMI8-5	1SNA176672R0100	10	12.20
		BJMI8-10	1SNA176673R0200	10	20.00
4 Cross spacing jumpers		EL6	1SNA173627R2100	10	0.10
5 Circuit separators	Grey <input type="checkbox"/>	SCAD	1SNA196896R0000	10	0.7
6 Test sockets		AL2	1SNA163043R2100	50	0.90
		AL3	1SNA163261R0000	50	1.20
		FC2	1SNA007865R2600	100	2.00
7 Test plugs	Black <input type="checkbox"/>	FC4	1SNA167860R0100	10	10.00
	White <input type="checkbox"/>	FC4	1SNA167860R0100	10	10.00
8 Tools		OUPAD	1SNA178944R0400	1	205.00
		OUMAD	1SNA179466R0600	1	29.00
9 Terminal block markers	White <input type="checkbox"/>	RC810	1SNA234000R0200	10	8.20

D1.5/6.S.ADO.NF IDC terminal blocks

Disconnect with plug - ADO System® - 6 mm 0.236 in spacing

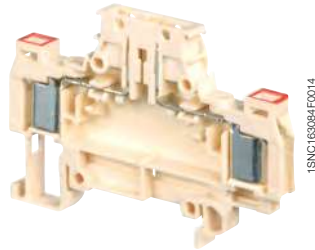

D1.5/6.S.ADO.NF

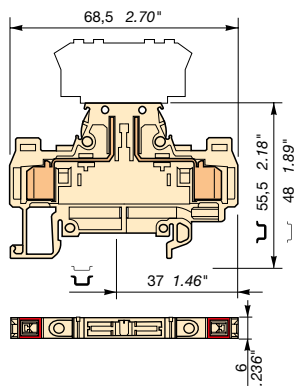

6 mm 0.236 in spacing

Description

- Ease your disconnect operations with the disconnect component holder plug,
- With the TE Connectivity ADO System®, experience the fastest and most reliable connection on the market,
- Designed for rolling stock applications exposed to severe constraints (vibrations, shocks etc.),
- Up to 2 wires per connection,
- Red marking to identify wire size.

Ordering details

Description	Color	Type	Part Numbers	Pkg qty	Weight (1 pce)
Disconnect With 2 test sockets DIA 2 mm 0.079 in	Beige <input type="checkbox"/>	D1.5/6.S.ADO.NF	1SNA400083R2500	50	8.00

Main technical data

Connecting capacity	NF F 63-808	NF F 63-296 NF F 63-826	EN 50306
ADO Flexible without ferrule	0.6 ... 1.82 mm²	0.5 ... 1.5 mm²	
Rated current	IEC		NF F 61-017
Rated short-time withstand current (1s)	10 A		
Rated voltage	180 A		
Impulse withstand voltage	500 V		
Protection	6000 V		
	IP20		

Mounting instructions

Rail		TH 35-7.5, TH 35-15
Tool		ADO system tool

--	--	--	--	--	--	--	--	--	--

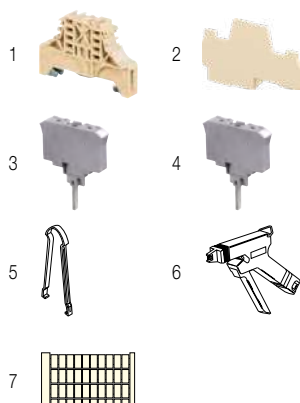

Accessories

Description	Color	Type	Part Numbers	Pkg qty	Weight (1 pce)
1 End stops 10 mm 0.394 in	Beige <input type="checkbox"/>	BAM2	1SNA296351R0000	50	12.00
2 End sections 2 mm 0.079 in	Beige <input type="checkbox"/>	FEDAD5	1SNA399804R0700	20	2.70
3 Component plugs With solder leads and screws	Beige <input type="checkbox"/>	BNSV62	1SNA196854R1500	50	6.00
		BNSV62-1	1SNA400142R0400	50	6.00
		BNF652	1SNA196998R1600	50	6.00
4 Short circuit plugs For 5x20 and 5x25 fuses	Beige <input type="checkbox"/>	BNC62	1SNA196853R1400	50	7.00
5 Extraction tools Equipped with linking bar		EXBN2	1SNA171018R2000	1	
6 Tools Semi automatic tool		OUPAD	1SNA178944R0400	1	205.00
		OUMAD	1SNA179466R0600	1	29.00
7 Terminal block markers Blank card	White <input type="checkbox"/>	RC610	1SNA233000R0100	10	7.50

D2.5/8.S.ADO.NF IDC terminal blocks

Disconnect with plug - ADO System® - 8 mm 0.315 in spacing

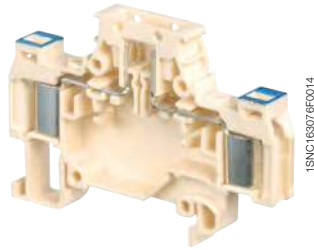

1SNC163076P0014

D2.5/8.S.ADO.NF

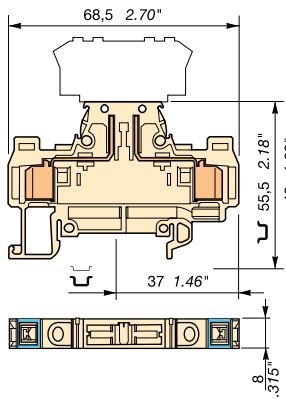

8 mm 0.315 in spacing

Description

- Ease your disconnect operations with the disconnect component holder plug,
- With the TE Connectivity ADO System®, experience the fastest and most reliable connection on the market,
- Designed for rolling stock applications exposed to severe constraints (vibrations, shocks etc.),
- Up to 2 wires per connection,
- Blue marking to identify wire size.

Ordering details

Description	Color	Type	Part Numbers	Pkg qty	Weight (1 pce) g
Disconnect With 2 test sockets DIA 2 mm 0.079 in	Beige <input type="checkbox"/>	D2.5/8.S.ADO.NF	1SNA399752R1100	50	11.00

Main technical data

Connecting capacity	NF F 63-808	NF F 63-296 NF F 63-826	EN 50306
ADO Flexible without ferrule	0.93 ... 2.61 mm²		1 ... 2.5 mm²
Rated current	IEC 15 A	NF F 61-017	
Rated short-time withstand current (1s)	300 A		
Rated voltage	500 V		
Impulse withstand voltage	6000 V		
Protection	IP20		

Mounting instructions

Rail		TH 35-7.5, TH 35-15
Tool		ADO system tool

--	--	--	--	--	--	--	--	--	--	--

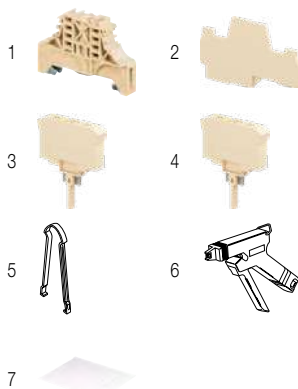

Accessories

Description	Color	Type	Part Numbers	Pkg qty	Weight (1 pce) g
1 End stops 10 mm 0.394 in	Beige <input type="checkbox"/>	BAM2	1SNA296351R0000	50	12.00
2 End sections 2 mm 0.079 in	Beige <input type="checkbox"/>	FEDAD5	1SNA399804R0700	20	2.70
3 Component plugs For 5x20 and 5x25 fuses With solder leads and screws	Beige <input type="checkbox"/>	BNF52	1SNA196924R0300	50	8.00
		BNSV82	1SNA196927R0600	50	8.00
4 Short circuit plugs Equipped with linking bar	Beige <input type="checkbox"/>	BNCT82	1SNA196926R0500	50	9.00
5 Extraction tools		EXBN2	1SNA171018R2000	1	
6 Tools Semi automatic tool		OUPAD	1SNA178944R0400	1	205.00
		OUMAD	1SNA179466R0600	1	29.00
7 Terminal block markers Blank card	White <input type="checkbox"/>	RC810	1SNA234000R0200	10	8.20

D1.5/6.D2.ADO.NF IDC terminal blocks

Feed-through - ADO System® - 6 mm 0.236 in spacing



1.82 mm²

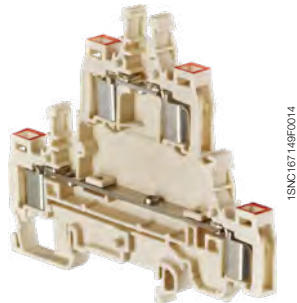

1SNC167149FC014

D1.5/6.D2.ADO.NF

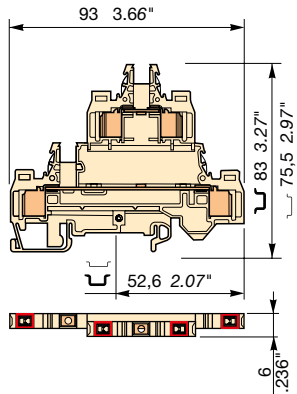

6 mm 0.236 in spacing

Description

- Save space with double deck terminal blocks: 2 independent circuits connected in just 6 mm 0.236 in spacing,
- With the TE Connectivity ADO System®, experience the fastest and most reliable connection on the market,
- Designed for rolling stock applications exposed to severe constrains (vibrations, shocks etc.),
- Up to 2 wires per connection,
- Red marking to identify wire size.

Ordering details

Description	Color	Type	Part Numbers	Pkg qty	Weight (1 pce) g
Feed-through	Beige <input type="checkbox"/>	D1.5/6.D2.ADO.NF	1SNA399742R1700	50	18.00

Main technical data

Connecting capacity	NF F 63-808	NF F 63-296 NF F 63-826	EN 50306
ADO Flexible without ferrule	0.6 ... 1.82 mm ²		0.5 ... 1.5 mm ²
	IEC	NF F 61-017	
Rated current	17.5 A	16 A	
Rated short-time withstand current (1s)	180 A		
Rated voltage	800 V	500 V	
Impulse withstand voltage	6000 V		
Protection	IP20		

Mounting instructions

Rail		TH 35-7.5, TH 35-15
Tool		ADO system tool

--	--	--	--	--	--	--	--	--	--	--	--	--	--	--	--	--	--	--	--

Accessories

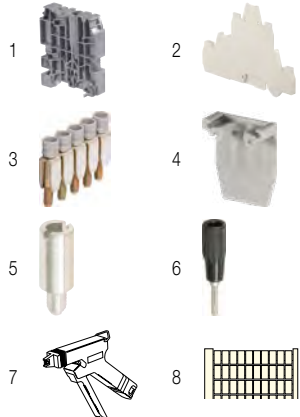

Description	Color	Type	Part Numbers	Pkg qty	Weight (1 pce) g
1 End stops	Grey <input type="checkbox"/>	BADH	1SNA116900R2700	50	20.00
2 End sections	Beige <input type="checkbox"/>	FED2AD2	1SNA399803R0600	20	7.00
3 Jumper bars		BJMI6-2	1SNA176663R0000	10	4.40
		BJMI6-3	1SNA176664R0100	10	6.70
		BJMI6-4	1SNA176665R0200	10	8.90
		BJMI6-5	1SNA176666R0300	10	11.20
		BJMI6-10	1SNA176667R0400	10	22.40
		BJS6-20	1SNA174784R2000	10	26.70
4 Circuit separators	Grey <input type="checkbox"/>	SCAD	1SNA196896R0000	10	0.7
5 Test sockets		AL2	1SNA163043R2100	50	0.90
		AL3	1SNA163261R0000	50	1.20
6 Test plugs	Black <input type="checkbox"/>	FC2	1SNA007865R2600	100	2.00
7 Tools		OUPAD	1SNA178944R0400	1	205.00
		OUMAD	1SNA179466R0600	1	29.00
8 Terminal block markers	White <input type="checkbox"/>	RC610	1SNA233000R0100	10	7.50
		RC65	1SNA232000R0000	10	3.60

D1.5/6.ADO.D2.NF IDC terminal blocks

Component holder - ADO System® - 6 mm 0.236 in spacing



D1.5/6.ADO.D2.NF

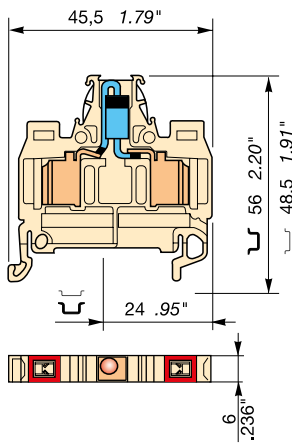

6 mm 0.236 in spacing

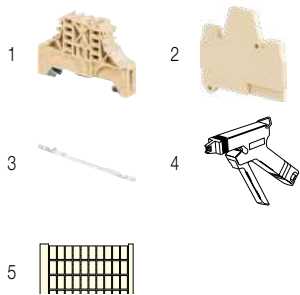

Description

- Terminal block equipped with a 1N5408 diode in series,
- With the TE Connectivity ADO System®, experience the fastest and most reliable connection on the market,
- Designed for rolling stock applications exposed to severe constraints (vibrations, shocks etc.),
- Up to 2 wires per connection,
- Red marking to identify wire size.

Ordering details

Description	Color	Type	Part Numbers	Pkg qty	Weight (1 pce)
Component holder Equipped with 1N5408 diode	Beige <input type="checkbox"/>	D1.5/6.ADO.D2.NF	1SNA399916R2600	50	7.00

Main technical data

Connecting capacity	NF F 63-808	NF F 63-296 NF F 63-826	EN 50306
ADO Flexible without ferrule	0.6 ... 1.82 mm²		0.5 ... 1.5 mm²
Rated current	IEC 1 A		NF F 61-017
Rated short-time withstand current (1s)			
Rated voltage	80 V		
Impulse withstand voltage			
Protection	IP20		

Mounting instructions

Rail	TH 35-7.5, TH 35-15
Tool	ADO system tool

CE	RoHS	EAC
----	------	-----

Accessories

Description	Color	Type	Part Numbers	Pkg qty	Weight (1 pce)
1 End stops 10 mm 0.394 in	Beige <input type="checkbox"/>	BAM2	1SNA296351R0000	50	12.00
2 End sections 3 mm 0.118 in	Beige <input type="checkbox"/>	FEMAD3	1SNA399802R0500	20	2.50
3 Shield connectors		CBM5	1SNA178745R1400	50	1
		CBM8	1SNA178746R1500	50	1
4 Tools		OUPAD	1SNA178944R0400	1	205.00
		OUMAD	1SNA179466R0600	1	29.00
5 Terminal block markers	White <input type="checkbox"/>	RC610	1SNA233000R0100	10	7.50
		RC65	1SNA232000R0000	10	3.60

D1.5/7.ADO-CPE.NF pluggable terminal blocks

Feed-through - ADO System® - 7.62 mm 0.3 in spacing

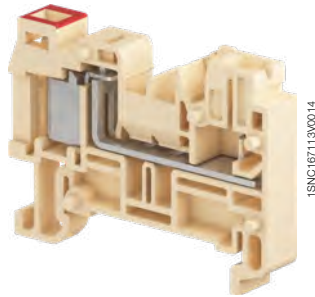

D1.5/7.ADO-CPE.NF

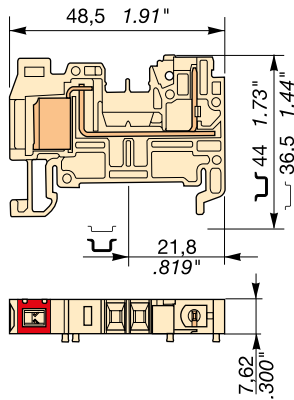

7.62 mm 0.3 in spacing

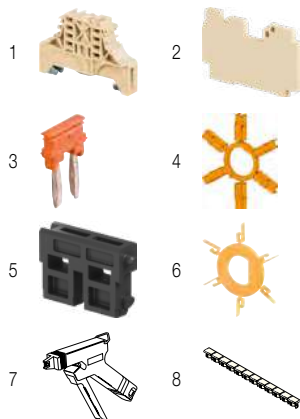

Description

- Increase your productivity with pluggable terminal blocks: possibility of pre-produced plugs harnesses, time saving plug & play assembly,
- With the TE Connectivity ADO System®, experience the fastest and most reliable connection on the market,
- Designed for rolling stock applications exposed to severe constrains (vibrations, shocks etc.),
- Up to 2 wires per connection,
- Red marking to identify wire size.

Ordering details

Description	Color	Type	Part Numbers	Pkg qty	Weight (1 pce) g
1 ADO - 1 pluggable 1 circuit	Beige	D1.5/7.ADO-CPE.NF	1SNA400153R0700	50	8.40

Main technical data

Connecting capacity	NF F 63-808	NF F 63-296 NF F 63-826	EN 50306
ADO Flexible without ferrule	0.6 ... 1.82 mm²		0.5 ... 1.5 mm²
	IEC	NF F 61-017	
Rated current	16 A	16 A	
Rated short-time withstand current (1s)	180 A		
Rated voltage	500 V	500 V	
Impulse withstand voltage			
Protection	IP20		

Mounting instructions

Rail		TH 35-7.5, TH 35-15
Tool		ADO system tool

--	--	--	--	--	--	--	--	--	--	--	--	--	--	--	--	--	--	--	--

Compatible products



Accessories

Description	Color	Type	Part Numbers	Pkg qty	Weight (1 pce) g
1 End stops 10 mm 0.394 in	Beige	BAM2	1SNA296351R0000	50	12.00
2 End sections 2.9 mm 0.114 in	Beige	FECPE.ADO	1SNA400019R0400	20	2.20
3 Jumper bars 10 poles	Orange	BJE762.10	1SNA290453R0500	10	24.00
2 poles		BJE762.2	1SNA290451R0300	10	5.30
5 poles		BJE762.5	1SNA290452R0400	10	15.40
4 Insulating tips For jumper bars type BJE762	Orange	EIP	1SNA290454R0600	10	100.00
5 Locking devices	Black	VRADO.CPE7	1SNA400063R0000	20	0.40
6 Coding pegs	Yellow	COCE	1SNA199321R2100	10	1.00
7 Tools Semi automatic tool		OUPAD	1SNA178944R0400	1	205.00
Hand tool		OUMAD	1SNA179466R0600	1	29.00
8 Terminal block markers Blank strip marker	White	RB-12W7	1SNA290455R0700	50	6.00

D2.5/7.ADO-CPE.NF1 pluggable terminal blocks

Feed-through - ADO System® - 7.62 mm 0.3 in spacing

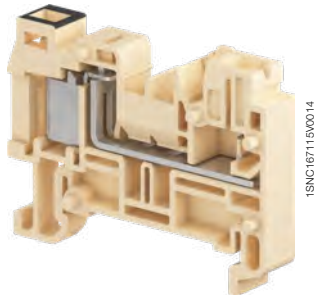

1SNC167119D014

D2.5/7.ADO-CPE.NF1

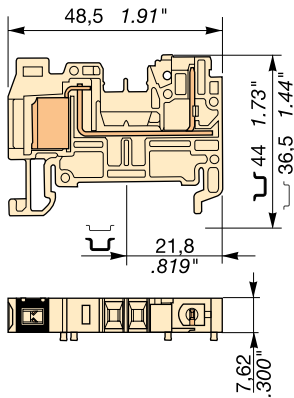

7.62 mm 0.3 in spacing

Description

- Increase your productivity with pluggable terminal blocks: possibility of pre-produced plugs harnesses, time saving plug & play assembly,
- With the TE Connectivity ADO System®, experience the fastest and most reliable connection on the market,
- Designed for rolling stock applications exposed to severe constraints (vibrations, shocks etc.),
- Up to 2 wires per connection,
- Black marking to identify wire size.

Ordering details

Description	Color	Type	Part Numbers	Pkg qty	Weight (1 pce)
1 ADO - 1 pluggable 1 circuit	Beige	D2.5/7.ADO-CPE.NF1	1SNA400156R0200	50	8.40

Main technical data

Connecting capacity	NF F 63-808	NF F 63-296 NF F 63-826	EN 50306
ADO Flexible without ferrule		1.5 mm²	
	IEC	NF F 61-017	
Rated current	24 A	16 A	
Rated short-time withstand current (1s)	180 A		
Rated voltage	500 V	500 V	
Impulse withstand voltage			
Protection	IP20		

Mounting instructions

Rail		TH 35-7.5, TH 35-15
Tool		ADO system tool

--	--	--	--	--	--	--	--	--	--	--

Compatible products



Accessories

Description	Color	Type	Part Numbers	Pkg qty	Weight (1 pce)
1 End stops 10 mm 0.394 in	Beige	BAM2	1SNA296351R0000	50	12.00
2 End sections 2.9 mm 0.114 in	Beige	FECPE.ADO	1SNA400019R0400	20	2.20
3 Jumper bars 10 poles	Orange	BJE762.10	1SNA290453R0500	10	24.00
2 poles		BJE762.2	1SNA290451R0300	10	5.30
5 poles		BJE762.5	1SNA290452R0400	10	15.40
4 Insulating tips For jumper bars type BJE762	Orange	EIP	1SNA290454R0600	10	100.00
5 Locking devices	Black	VRADO.CPE7	1SNA400063R0000	20	0.40
6 Coding pegs	Yellow	COCE	1SNA199321R2100	10	1.00
7 Tools Semi automatic tool		OUPAD	1SNA178944R0400	1	205.00
Hand tool		OUMAD	1SNA179466R0600	1	29.00
8 Terminal block markers Blank strip marker	White	RB-12W7	1SNA290455R0700	50	6.00

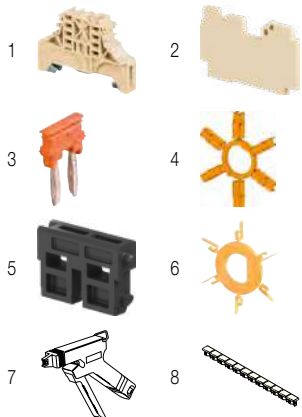

D1.5/7.2ADO-CPE.NF pluggable terminal blocks

Feed-through - ADO System® - 7.62 mm 0.3 in spacing

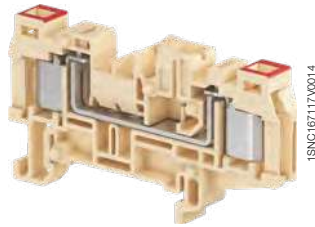

D1.5/7.2ADO-CPE.NF

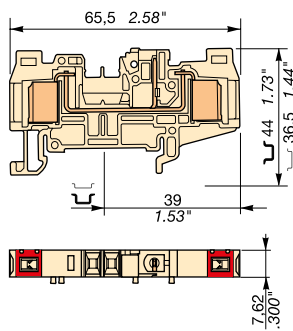

7.62 mm 0.3 in spacing

Description

- Increase your productivity with pluggable terminal blocks: possibility of pre-produced plugs harnesses, time saving plug & play assembly,
- With the TE Connectivity ADO System®, experience the fastest and most reliable connection on the market,
- Designed for rolling stock applications exposed to severe constrains (vibrations, shocks etc.),
- Up to 2 wires per connection,
- Red marking to identify wire size.

Ordering details

Description	Color	Type	Part Numbers	Pkg qty	Weight (1 pce) g
2 ADO - 1 pluggable 1 circuit	Beige <input type="checkbox"/>	D1.5/7.2ADO-CPE.NF	1SNA400154R0000	50	11.00

Main technical data

Connecting capacity	NF F 63-808	NF F 63-296 NF F 63-826	EN 50306	Rail	TH 35-7.5, TH 35-15
ADO Flexible without ferrule	0.6 ... 1.82 mm²		0.5 ... 1.5 mm²	Tool	ADO system tool
	IEC	NF F 61-017			
Rated current	16 A	16 A			
Rated short-time withstand current (1s)	180 A				
Rated voltage	500 V	500 V			
Impulse withstand voltage					
Protection	IP20				
CE	RoHS	ERC			
CE	RoHS	EAC			

Mounting instructions

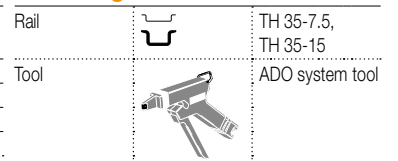

Compatible products

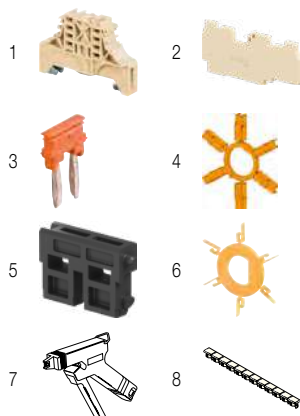

Accessories

Description	Color	Type	Part Numbers	Pkg qty	Weight (1 pce) g
1 End stops 10 mm 0.394 in	Beige <input type="checkbox"/>	BAM2	1SNA296351R0000	50	12.00
2 End sections 2.9 mm 0.114 in	Beige <input type="checkbox"/>	FECPE.2ADO	1SNA400018R0300	20	2.20
3 Jumper bars 10 poles	Orange <input type="checkbox"/>	BJE762.10	1SNA290453R0500	10	24.00
2 poles		BJE762.2	1SNA290451R0300	10	5.30
5 poles		BJE762.5	1SNA290452R0400	10	15.40
4 Insulating tips For jumper bars type BJE762	Orange <input type="checkbox"/>	EIP	1SNA290454R0600	10	100.00
5 Locking devices	Black <input type="checkbox"/>	VRADO.CPE7	1SNA400063R0000	20	0.40
6 Coding pegs	Yellow <input type="checkbox"/>	COCE	1SNA199321R2100	10	1.00
7 Tools Semi automatic tool		OUPAD	1SNA178944R0400	1	205.00
Hand tool		OUMAD	1SNA179466R0600	1	29.00
8 Terminal block markers Blank strip marker	White <input type="checkbox"/>	RB-12W7	1SNA290455R0700	50	6.00

D2.5/7.ADO-CPE.NF pluggable terminal blocks

Feed-through - ADO System® - 7.62 mm 0.3 in spacing

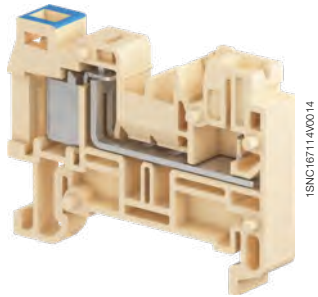

D2.5/7.ADO-CPE.NF

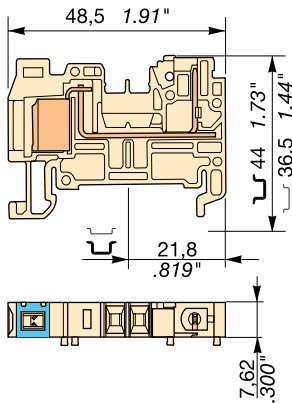

7.62 mm 0.3 in spacing

Description

- Increase your productivity with pluggable terminal blocks: possibility of pre-produced plugs harnesses, time saving plug & play assembly,
- With the TE Connectivity ADO System®, experience the fastest and most reliable connection on the market,
- Designed for rolling stock applications exposed to severe constraints (vibrations, shocks etc.),
- Up to 2 wires per connection,
- Blue marking to identify wire size.

Ordering details

Description	Color	Type	Part Numbers	Pkg qty	Weight (1 pce)
1 ADO - 1 pluggable 1 circuit	Beige	D2.5/7.ADO-CPE.NF	1SNA400061R0600	50	8.40

Main technical data

Connecting capacity	NF F 63-808	NF F 63-296 NF F 63-826	EN 50306
ADO Flexible without ferrule	0.93 ... 2.61 mm ²	1 ... 2.5 mm ²	
	IEC	NF F 61-017	
Rated current	24 A	16 A	
Rated short-time withstand current (1s)	300 A		
Rated voltage	500 V	500 V	
Impulse withstand voltage			
Protection	IP20		

Mounting instructions

Rail		TH 35-7.5, TH 35-15
Tool		ADO system tool

--	--	--	--	--	--	--	--	--	--

Compatible products



Accessories

Description	Color	Type	Part Numbers	Pkg qty	Weight (1 pce)
1 End stops 10 mm 0.394 in	Beige	BAM2	1SNA296351R0000	50	12.00
2 End sections 2.9 mm 0.114 in	Beige	FECPE.ADO	1SNA400019R0400	20	2.20
3 Jumper bars 10 poles	Orange	BJE762.10	1SNA290453R0500	10	24.00
2 poles		BJE762.2	1SNA290451R0300	10	5.30
5 poles		BJE762.5	1SNA290452R0400	10	15.40
4 Insulating tips For jumper bars type BJE762	Orange	EIP	1SNA290454R0600	10	100.00
5 Locking devices	Black	VRADO.CPE7	1SNA400063R0000	20	0.40
6 Coding pegs	Yellow	COCE	1SNA199321R2100	10	1.00
7 Tools Semi automatic tool		OUPAD	1SNA178944R0400	1	205.00
Hand tool		OUMAD	1SNA179466R0600	1	29.00
8 Terminal block markers Blank strip marker	White	RB-12W7	1SNA290455R0700	50	6.00

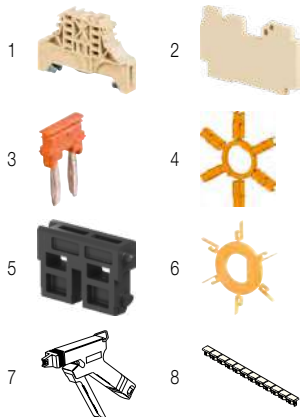

D2.5/7.2ADO-CPE.NF pluggable terminal blocks

Feed-through - ADO System® - 7.62 mm 0.3 in spacing



2.61 mm²

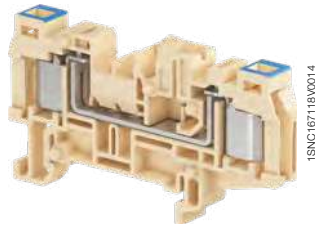

1SNC167118W0014

D2.5/7.2ADO-CPE.NF

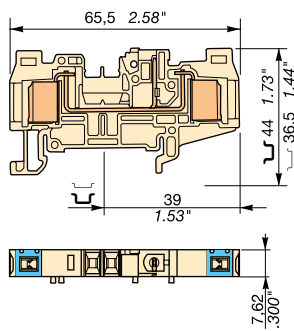

7.62 mm 0.3 in spacing

Description

- Increase your productivity with pluggable terminal blocks: possibility of pre-produced plugs harnesses, time saving plug & play assembly,
- With the TE Connectivity ADO System®, experience the fastest and most reliable connection on the market,
- Designed for rolling stock applications exposed to severe constrains (vibrations, shocks etc.),
- Up to 2 wires per connection,
- Blue marking to identify wire size.

Ordering details

Description	Color	Type	Part Numbers	Pkg qty	Weight (1 pce) g
2 ADO - 1 pluggable 1 circuit	Beige <input type="checkbox"/>	D2.5/7.2ADO-CPE.NF	1SNA400062R0700	50	11.00

Main technical data

Connecting capacity	NF F 63-808	NF F 63-296 NF F 63-826	EN 50306	Rail	TH 35-7.5, TH 35-15
ADO Flexible without ferrule	0.93 ... 2.61 mm ²	1 ... 2.5 mm ²		Tool	ADO system tool
	IEC	NF F 61-017			
Rated current	24 A	16 A			
Rated short-time withstand current (1s)	300 A				
Rated voltage	500 V	500 V			
Impulse withstand voltage					
Protection	IP20				
CE	RoHS	ERC			
CE	RoHS	EAC			

Mounting instructions

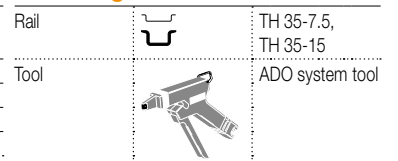

Compatible products



Accessories

Description	Color	Type	Part Numbers	Pkg qty	Weight (1 pce) g
1 End stops 10 mm 0.394 in	Beige <input type="checkbox"/>	BAM2	1SNA296351R0000	50	12.00
2 End sections 2.9 mm 0.114 in	Beige <input type="checkbox"/>	FECPE.2ADO	1SNA400018R0300	20	2.20
3 Jumper bars 10 poles	Orange <input type="checkbox"/>	BJE762.10	1SNA290453R0500	10	24.00
2 poles		BJE762.2	1SNA290451R0300	10	5.30
5 poles		BJE762.5	1SNA290452R0400	10	15.40
4 Insulating tips For jumper bars type BJE762	Orange <input type="checkbox"/>	EIP	1SNA290454R0600	10	100.00
5 Locking devices	Black <input type="checkbox"/>	VRADO.CPE7	1SNA400063R0000	20	0.40
6 Coding pegs	Yellow <input type="checkbox"/>	COCE	1SNA199321R2100	10	1.00
7 Tools Semi automatic tool		OUPAD	1SNA178944R0400	1	205.00
Hand tool		OUMAD	1SNA179466R0600	1	29.00
8 Terminal block markers Blank strip marker	White <input type="checkbox"/>	RB-12W7	1SNA290455R0700	50	6.00

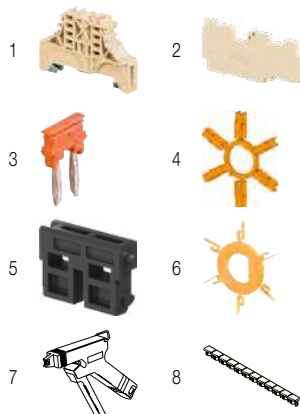

1SNC167006S0201

D4/7.ADO-CPE.NF pluggable terminal blocks

Feed-through - ADO System® - 7.62 mm 0.3 in spacing

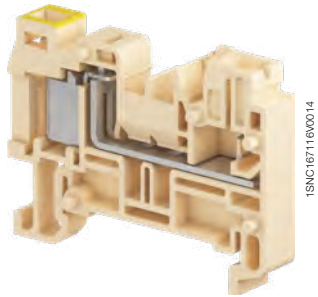

D4/7.ADO-CPE.NF

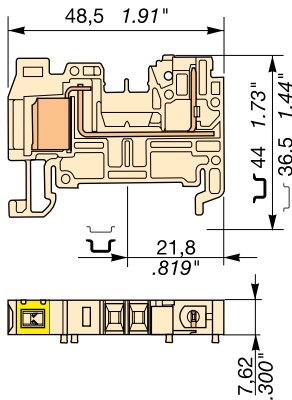

7.62 mm 0.3 in spacing

Description

- Increase your productivity with pluggable terminal blocks: possibility of pre-produced plugs harnesses, time saving plug & play assembly,
- With the TE Connectivity ADO System®, experience the fastest and most reliable connection on the market,
- Designed for rolling stock applications exposed to severe constrains (vibrations, shocks etc.),
- Up to 2 wires per connection,
- Yellow marking to identify wire size.

Ordering details

Description	Color	Type	Part Numbers	Pkg qty	Weight (1 pce)
1 ADO - 1 pluggable 1 circuit	Beige <input type="checkbox"/>	D4/7.ADO-CPE.NF	1SNA400240R2200	50	8.40

Main technical data

Connecting capacity	NF F 63-808	NF F 63-296	EN 50306
ADO Flexible without ferrule	4.32 mm²	NF F 63-826	
	IEC	NF F 61-017	
Rated current	24 A	16 A	
Rated short-time withstand current (1s)	480 A		
Rated voltage	500 V	500 V	
Impulse withstand voltage			
Protection	IP20		

Mounting instructions

Rail		TH 35-7.5, TH 35-15
Tool		ADO system tool

--	--	--	--	--	--	--	--	--	--	--	--	--	--	--	--	--	--	--	--

Compatible products



Accessories

Description	Color	Type	Part Numbers	Pkg qty	Weight (1 pce)	
1 End stops 10 mm 0.394 in	Beige <input type="checkbox"/>	BAM2	1SNA296351R0000	50	12.00	
2 End sections 2.9 mm 0.114 in	Beige <input type="checkbox"/>	FECPE.ADO	1SNA400019R0400	20	2.20	
3 Jumper bars	Orange <input type="checkbox"/>	10 poles	BJE762.10	1SNA290453R0500	10	24.00
		2 poles	BJE762.2	1SNA290451R0300	10	5.30
		5 poles	BJE762.5	1SNA290452R0400	10	15.40
4 Insulating tips For jumper bars type BJE762	Orange <input type="checkbox"/>	EIP	1SNA290454R0600	10	100.00	
5 Locking devices	Black <input type="checkbox"/>	VRADO.CPE7	1SNA400063R0000	20	0.40	
6 Coding pegs	Yellow <input type="checkbox"/>	COCE	1SNA199321R2100	10	1.00	
7 Tools		OUPAD	1SNA178944R0400	1	205.00	
		OUMAD	1SNA179466R0600	1	29.00	
8 Terminal block markers Blank strip marker	White <input type="checkbox"/>	RB-12W7	1SNA290455R0700	50	6.00	

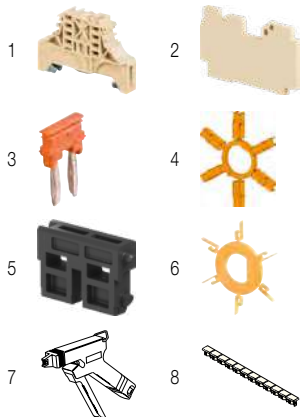

D4/7.2ADO-CPE.NF pluggable terminal blocks

Feed-through - ADO System® - 7.62 mm 0.3 in spacing



4.32 mm²

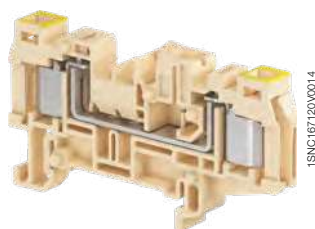

1SNC167120V0014

D4/7.2ADO-CPE.NF

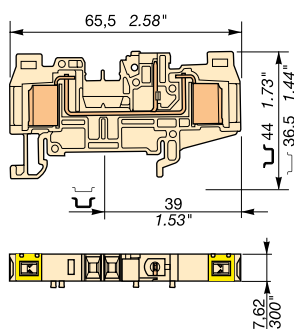

7.62 mm 0.3 in spacing

Description

- Increase your productivity with pluggable terminal blocks: possibility of pre-produced plugs harnesses, time saving plug & play assembly,
- With the TE Connectivity ADO System®, experience the fastest and most reliable connection on the market,
- Designed for rolling stock applications exposed to severe constrains (vibrations, shocks etc.),
- Up to 2 wires per connection,
- Yellow marking to identify wire size.

Ordering details

Description	Color	Type	Part Numbers	Pkg qty	Weight (1 pce) g
2 ADO - 1 pluggable 1 circuit	Beige <input type="checkbox"/>	D4/7.2ADO-CPE.NF	1SNA400241R1700	50	11.00

Main technical data

Connecting capacity	NF F 63-808	NF F 63-296 NF F 63-826	EN 50306
ADO Flexible without ferrule	4.32 mm ²		
	IEC	NF F 61-017	
Rated current	24 A	16 A	
Rated short-time withstand current (1s)	480 A		
Rated voltage	500 V	500 V	
Impulse withstand voltage			
Protection	IP20		

Mounting instructions

Rail		TH 35-7.5, TH 35-15
Tool		ADO system tool

--	--	--	--	--	--	--	--	--	--	--

Compatible products

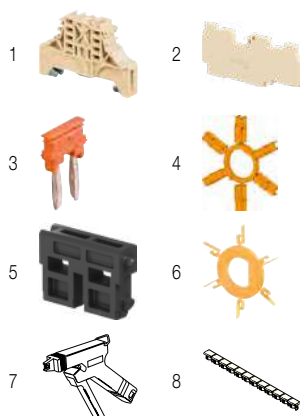

Accessories

Description	Color	Type	Part Numbers	Pkg qty	Weight (1 pce) g
1 End stops 10 mm 0.394 in	Beige <input type="checkbox"/>	BAM2	1SNA296351R0000	50	12.00
2 End sections 2.9 mm 0.114 in	Beige <input type="checkbox"/>	FECPE.2ADO	1SNA400018R0300	20	2.20
3 Jumper bars 10 poles	Orange <input type="checkbox"/>	BJE762.10	1SNA290453R0500	10	24.00
2 poles		BJE762.2	1SNA290451R0300	10	5.30
5 poles		BJE762.5	1SNA290452R0400	10	15.40
4 Insulating tips For jumper bars type BJE762	Orange <input type="checkbox"/>	EIP	1SNA290454R0600	10	100.00
5 Locking devices	Black <input type="checkbox"/>	VRADO.CPE7	1SNA400063R0000	20	0.40
6 Coding pegs	Yellow <input type="checkbox"/>	COCE	1SNA199321R2100	10	1.00
7 Tools Semi automatic tool		OUPAD	1SNA178944R0400	1	205.00
Hand tool		OUMAD	1SNA179466R0600	1	29.00
8 Terminal block markers Blank strip marker	White <input type="checkbox"/>	RB-12W7	1SNA290455R0700	50	6.00

D2.5/7.2CPE pluggable terminal blocks

Feed-through - ADO System® - 7.62 mm 0.3 in spacing

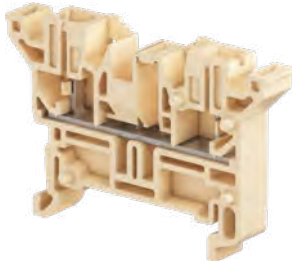

1SNC167083V0014

D2.5/7.2CPE

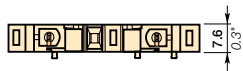
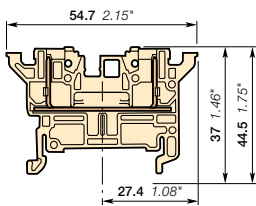

7.62 mm 0.3 in spacing

Description

- Increase your productivity with pluggable terminal blocks: possibility of pre-produced plugs harnesses, time saving plug & play assembly,
- With the TE Connectivity ADO System®, experience the fastest and most reliable connection on the market,
- Designed for rolling stock applications exposed to severe constraints (vibrations, shocks etc.),
- 1 plug on each side: 1 circuit.

Ordering details

Description	Color	Type	Part Numbers	Pkg qty	Weight (1 pce) g
2 pluggables 1 circuit	Beige	D2.5/7.2CPE	1SNA400703R1700	50	7.00

Main technical data

Connecting capacity	NF F 63-808	NF F 63-296 NF F 63-826	EN 50306
ADO Flexible without ferrule			

	IEC	NF F 61-017
Rated current	16 A	16 A
Rated short-time withstand current (1s)		
Rated voltage	500 V	500 V
Impulse withstand voltage		
Protection	IP20	

Mounting instructions

Rail		TH 35-7.5, TH 35-15
Tool		ADO system tool

--	--	--	--	--	--	--	--	--	--

Compatible products



Accessories

Description	Color	Type	Part Numbers	Pkg qty	Weight (1 pce) g
1 End stops 10 mm 0.394 in	Beige	BAM2	1SNA296351R0000	50	12.00
2 End sections 2.8 mm 0.11 in	Beige	FECPE	1SNA400708R2400	20	1.90
3 Jumper bars 10 poles	Orange	BJE762.10	1SNA290453R0500	10	24.00
2 poles		BJE762.2	1SNA290451R0300	10	5.30
5 poles		BJE762.5	1SNA290452R0400	10	15.40
4 Insulating tips For jumper bars type BJE762	Orange	EIP	1SNA290454R0600	10	100.00
5 Locking devices	Black	VRADO.CPE7	1SNA400063R0000	20	0.40
6 Coding pegs	Yellow	COCE	1SNA199321R2100	10	1.00
7 Terminal block markers Blank strip marker	White	RB-12W7	1SNA290455R0700	50	6.00

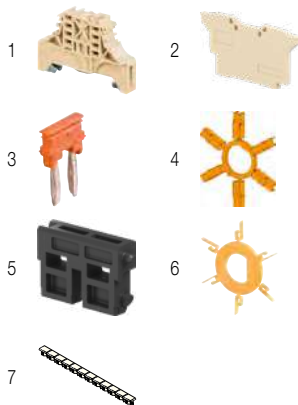

D2.5/7.CPE.CPE pluggable terminal blocks

Feed-through - ADO System® - 7.62 mm 0.3 in spacing

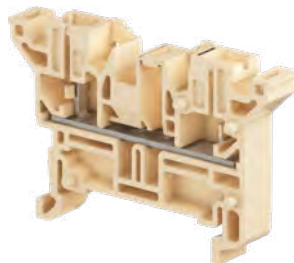

1SNC167121V0014

D2.5/7.CPE.CPE

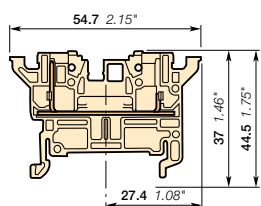

7.62 mm 0.3 in spacing

Description

- Increase your productivity with pluggable terminal blocks: possibility of pre-produced plugs harnesses, time saving plug & play assembly,
- With the TE Connectivity ADO System®, experience the fastest and most reliable connection on the market,
- Designed for rolling stock applications exposed to severe constraints (vibrations, shocks etc.),
- 1 plug on each side: 2 circuits.

Ordering details

Description	Color	Type	Part Numbers	Pkg qty	Weight (1 pce) g
2 pluggables 2 circuits	Beige	D2.5/7.CPE.CPE	1SNA400704R1000	50	7.00

Main technical data

Connecting capacity	NF F 63-808	NF F 63-296 NF F 63-826	EN 50306	Mounting instructions
ADO Flexible without ferrule				Rail TH 35-7.5, TH 35-15 Tool ADO system tool
	IEC	NF F 61-017		
Rated current	16 A	16 A		
Rated short-time withstand current (1s)				
Rated voltage	500 V	500 V		
Impulse withstand voltage				
Protection	IP20			
	CE	RoHS	ERC	EAC

Compatible products

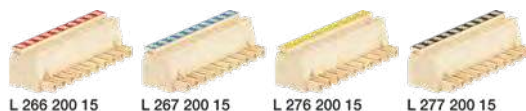

Accessories

Description	Color	Type	Part Numbers	Pkg qty	Weight (1 pce) g
1 End stops 10 mm 0.394 in	Beige	BAM2	1SNA296351R0000	50	12.00
2 End sections 2.8 mm 0.11 in	Beige	FECPE	1SNA400708R2400	20	1.90
3 Jumper bars 10 poles	Orange	BJE762.10	1SNA290453R0500	10	24.00
2 poles		BJE762.2	1SNA290451R0300	10	5.30
5 poles		BJE762.5	1SNA290452R0400	10	15.40
4 Insulating tips For jumper bars type BJE762	Orange	EIP	1SNA290454R0600	10	100.00
5 Locking devices	Black	VRADO.CPE7	1SNA400063R0000	20	0.40
6 Coding pegs	Yellow	COCE	1SNA199321R2100	10	1.00
7 Terminal block markers Blank strip marker	White	RB-12W7	1SNA290455R0700	50	6.00

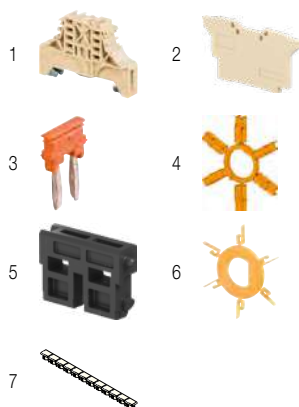

1SNC167031S0201

L 266 200 15 female plugs

ADO System® - 7.62 mm 0.3 in spacing



1.82 mm²



L 266 200 15

1SNC16712V0014

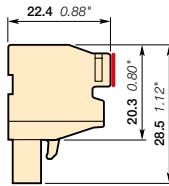
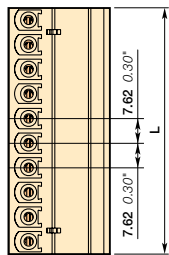

L = nb poles x 7.62

7.62 mm 0.3 in spacing

Description

- With the TE Connectivity ADO System®, experience the fastest and most reliable connection on the market,
- Designed for rolling stock applications exposed to severe constraints (vibrations, shocks etc.),
- Up to 2 wires per connection,
- Red marking to identify wire size.

Ordering details

Description	Color	Type	Part Numbers	Pkg qty	Weight (1 pce) g
Female plugs					
2 poles	Beige	FIC F.ADO.T1.2P.NF	1SSS266202R8800	50	6.00
3 poles	Beige	FIC F.ADO.T1.3P.NF	1SSS266203R8800	50	10.00
4 poles	Beige	FIC F.ADO.T1.4P.NF	1SSS266204R8800	50	13.00
5 poles	Beige	FIC F.ADO.T1.5P.NF	1SSS266205R8800	50	16.00
6 poles	Beige	FIC F.ADO.T1.6P.NF	1SSS266206R8800	50	19.00
7 poles	Beige	FIC F.ADO.T1.7P.NF	1SSS266207R8800	50	22.00
8 poles	Beige	FIC F.ADO.T1.8P.NF	1SSS266208R8800	50	26.00
9 poles	Beige	FIC F.ADO.T1.9P.NF	1SSS266209R8800	50	29.00
10 poles	Beige	FIC F.ADO.T1.10P.NF	1SSS266210R8800	50	32.00

Main technical data

Connecting capacity	NF F 63-808	NF F 63-296 NF F 63-826	EN 50306
ADO Flexible without ferrule	0.6 ... 1.82 mm ²		0.5 ... 1.5 mm ²
Rated current	16 A	16 A	
Rated short-time withstand current (1s)	218.4 A		
Rated voltage	500 V	500 V	
Impulse withstand voltage			
Protection	IP20		

Mounting instructions

Tool	ADO system tool

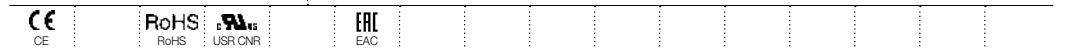

Compatible products



Accessories

Description	Color	Type	Part Numbers	Pkg qty	Weight (1 pce) g
1 Cable clamps	Beige	PT1	1SSS299253R2800	20	1.60
		PT2	1SSS299254R2800	20	4.80
2 Coding pegs	Yellow	COCF	1SNA199320R0400	10	1.00
3 Tools		OUPAD	1SNA178944R0400	1	205.00
		OUMAD	1SNA179466R0600	1	29.00
4 Terminal block markers	White	RB-12W7	1SNA290455R0700	50	6.00

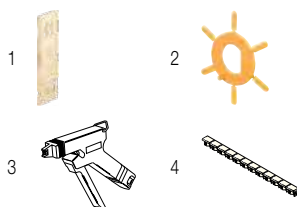

L 266 200 25 female plugs with brackets

ADO System® - 7.62 mm 0.3 in spacing



1.82 mm²



L 266 200 25

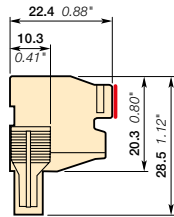
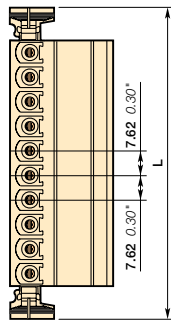

$L = (\text{nb poles} \times 7.62) + 13.7$

7.62 mm 0.3 in spacing

Description

- With the TE Connectivity ADO System®, experience the fastest and most reliable connection on the market,
- Designed for rolling stock applications exposed to severe constraints (vibrations, shocks etc.),
- Up to 2 wires per connection,
- Red marking to identify wire size.

Ordering details

Description	Color	Type	Part Numbers	Pkg qty	Weight (1 pce) g
Female plugs					
2 poles	Beige <input type="checkbox"/>	FIC F.ADO.T1.B.2P.NF	1SSS266202R9800	50	7.40
3 poles	Beige <input type="checkbox"/>	FIC F.ADO.T1.B.3P.NF	1SSS266203R9800	50	10.00
4 poles	Beige <input type="checkbox"/>	FIC F.ADO.T1.B.4P.NF	1SSS266204R9800	50	14.00
5 poles	Beige <input type="checkbox"/>	FIC F.ADO.T1.B.5P.NF	1SSS266205R9800	50	18.00
6 poles	Beige <input type="checkbox"/>	FIC F.ADO.T1.B.6P.NF	1SSS266206R9800	50	21.00
8 poles	Beige <input type="checkbox"/>	FIC F.ADO.T1.B.8P.NF	1SSS266208R9800	50	28.00
10 poles	Beige <input type="checkbox"/>	FIC F.ADO.T1.B.10P.NF	1SSS266210R9800	50	35.00

Main technical data

Connecting capacity	NF F 63-808	NF F 63-296	EN 50306
ADO Flexible without ferrule	0.6 ... 1.82 mm ²	NF F 63-826	0.5 ... 1.5 mm ²
Rated current	IEC 16 A	NF F 61-017 16 A	
Rated short-time withstand current (1s)	218.4 A		
Rated voltage	500 V	500 V	
Impulse withstand voltage			
Protection	IP20		

Mounting instructions

Tool	ADO system tool

--	--	--	--	--	--	--	--	--	--	--	--	--	--	--	--	--	--	--	--	--

Compatible products



Accessories

Description	Color	Type	Part Numbers	Pkg qty	Weight (1 pce) g
1 Cable clamps	Beige <input type="checkbox"/>	PT1	1SSS299253R2800	20	1.60
		PT2	1SSS299254R2800	20	4.80
2 Coding pegs	Yellow <input type="checkbox"/>	COCF	1SNA199320R0400	10	1.00
3 Tools		OUPAD	1SNA178944R0400	1	205.00
		OUMAD	1SNA179466R0600	1	29.00
4 Terminal block markers	White <input type="checkbox"/>	RB-12W7	1SNA290455R0700	50	6.00

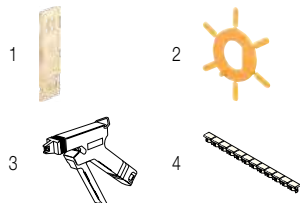

L 277 200 15 female plugs

ADO System® - 7.62 mm 0.3 in spacing



L 277 200 15

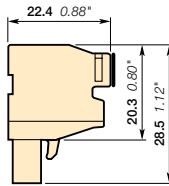
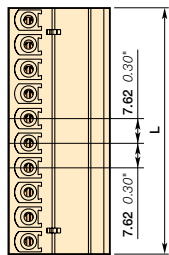

L = nb poles x 7.62
7.62 mm 0.3 in spacing

Description

- With the TE Connectivity ADO System®, experience the fastest and most reliable connection on the market,
- Designed for rolling stock applications exposed to severe constraints (vibrations, shocks etc.),
- Up to 2 wires per connection,
- Black marking to identify wire size.

Ordering details

Description	Color	Type	Part Numbers	Pkg qty	Weight (1 pce) g
Female plugs					
2 poles	Beige <input type="checkbox"/>	FIC F.ADO.T3-.2P.NF	1SSS277202R8800	50	6.00
3 poles	Beige <input type="checkbox"/>	FIC F.ADO.T3-.3P.NF	1SSS277203R8800	50	10.00
4 poles	Beige <input type="checkbox"/>	FIC F.ADO.T3-.4P.NF	1SSS277204R8800	50	13.00
5 poles	Beige <input type="checkbox"/>	FIC F.ADO.T3-.5P.NF	1SSS277205R8800	50	16.00
6 poles	Beige <input type="checkbox"/>	FIC F.ADO.T3-.6P.NF	1SSS277206R8800	50	19.00

Main technical data

Connecting capacity	NF F 63-808	NF F 63-296 NF F 63-826	EN 50306
ADO	Flexible without ferrule	1.5 mm ²	
Rated current	24 A	16 A	
Rated short-time withstand current (1s)	180 A		
Rated voltage	500 V	500 V	
Impulse withstand voltage			
Protection	IP20		

Mounting instructions

Rail		
Tool		ADO system tool

CE	RoHS	EAC							
----	------	-----	--	--	--	--	--	--	--

Compatible products



Accessories

Description	Color	Type	Part Numbers	Pkg qty	Weight (1 pce) g
1 Cable clamps	Beige <input type="checkbox"/>	PT1 PT2	1SSS299253R2800 1SSS299254R2800	20 20	1.60 4.80
2 Coding pegs	Yellow <input type="checkbox"/>	COCF	1SNA199320R0400	10	1.00
3 Tools		OUPAD OUMAD	1SNA178944R0400 1SNA179466R0600	1 1	205.00 29.00
4 Terminal block markers	White <input type="checkbox"/>	RB-12W7	1SNA290455R0700	50	6.00

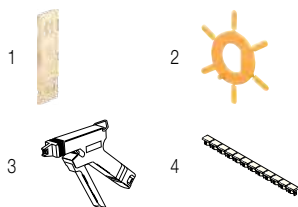

L 267 200 15 female plugs

ADO System® - 7.62 mm 0.3 in spacing



L 267 200 15

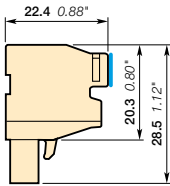
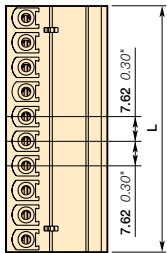

L = nb poles x 7.62

7.62 mm 0.3 in spacing

Description

- With the TE Connectivity ADO System®, experience the fastest and most reliable connection on the market,
- Designed for rolling stock applications exposed to severe constraints (vibrations, shocks etc.),
- Up to 2 wires per connection,
- Blue marking to identify wire size.

Ordering details

Description	Color	Type	Part Numbers	Pkg qty	Weight (1 pce)
Female plugs					
2 poles	Beige <input type="checkbox"/>	FIC F.ADO.T2.2P.NF	1SSS267202R8800	50	6.00
3 poles	Beige <input type="checkbox"/>	FIC F.ADO.T2.3P.NF	1SSS267203R8800	50	10.00
4 poles	Beige <input type="checkbox"/>	FIC F.ADO.T2.4P.NF	1SSS267204R8800	50	13.00
5 poles	Beige <input type="checkbox"/>	FIC F.ADO.T2.5P.NF	1SSS267205R8800	50	16.00
6 poles	Beige <input type="checkbox"/>	FIC F.ADO.T2.6P.NF	1SSS267206R8800	50	19.00
7 poles	Beige <input type="checkbox"/>	FIC F.ADO.T2.7P.NF	1SSS267207R8800	50	22.00
8 poles	Beige <input type="checkbox"/>	FIC F.ADO.T2.8P.NF	1SSS267208R8800	50	26.00
10 poles	Beige <input type="checkbox"/>	FIC F.ADO.T2.10P.NF	1SSS267210R8800	50	32.00

Main technical data

Connecting capacity	NF F 63-808	NF F 63-296 NF F 63-826	EN 50306
ADO Flexible without ferrule	0.93 ... 2.61 mm²	1 ... 2.5 mm²	
Rated current	24 A	16 A	
Rated short-time withstand current (1s)	313.2 A		
Rated voltage	500 V	500 V	
Impulse withstand voltage			
Protection	IP20		

Mounting instructions

Tool	ADO system tool

--	--	--	--

Compatible products



Accessories

Description	Color	Type	Part Numbers	Pkg qty	Weight (1 pce)
1 Cable clamps	Beige <input type="checkbox"/>	PT1 PT2	1SSS299253R2800 1SSS299254R2800	20	1.60 4.80
2 Coding pegs	Yellow <input type="checkbox"/>	COCF	1SNA199320R0400	10	1.00
3 Tools		OUPAD OUMAD	1SNA178944R0400 1SNA179466R0600	1	205.00 29.00
4 Terminal block markers	White <input type="checkbox"/>	RB-12W7	1SNA290455R0700	50	6.00

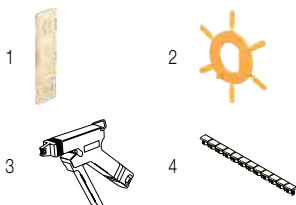

L 267 200 25 female plugs with brackets

ADO System® - 7.62 mm 0.3 in spacing



2.61 mm²



1SNC167125V0014

L 267 200 25

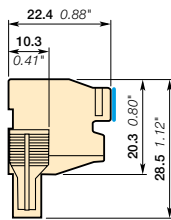
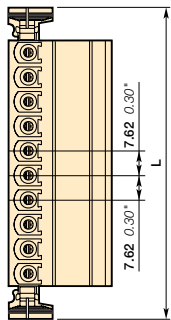

$L = (\text{nb poles} \times 7.62) + 13.7$

7.62 mm 0.3 in spacing

Description

- With the TE Connectivity ADO System®, experience the fastest and most reliable connection on the market,
- Designed for rolling stock applications exposed to severe constraints (vibrations, shocks etc.),
- Up to 2 wires per connection,
- Blue marking to identify wire size.

Ordering details

Description	Color	Type	Part Numbers	Pkg qty	Weight (1 pce) g
Female plugs					
2 poles	Beige <input type="checkbox"/>	FIC F.ADO.T2.B.2PNF	1SSS267202R9800	50	7.40
3 poles	Beige <input type="checkbox"/>	FIC F.ADO.T2.B.3PNF	1SSS267203R9800	50	11.00
4 poles	Beige <input type="checkbox"/>	FIC F.ADO.T2.B.4PNF	1SSS267204R9800	50	14.00
5 poles	Beige <input type="checkbox"/>	FIC F.ADO.T2.B.5PNF	1SSS267205R9800	50	18.00
6 poles	Beige <input type="checkbox"/>	FIC F.ADO.T2.B.6PNF	1SSS267206R9800	50	21.00
8 poles	Beige <input type="checkbox"/>	FIC F.ADO.T2.B.8PNF	1SSS267208R9800	50	28.00
10 poles	Beige <input type="checkbox"/>	FIC F.ADO.T2.B.10PNF	1SSS267210R9800	50	35.00
16 poles	Beige <input type="checkbox"/>	FIC F.ADO.T2.B.16PNF	1SSS267216R9800	20	57.00

Main technical data

Connecting capacity	NF F 63-808	NF F 63-296 NF F 63-826	EN 50306
ADO Flexible without ferrule	0.93 ... 2.61 mm ²		1 ... 2.5 mm ²
Rated current	24 A	16 A	
Rated short-time withstand current (1s)	313.2 A		
Rated voltage	500 V	500 V	
Impulse withstand voltage			
Protection	IP20		

Mounting instructions

Rail		
Tool		ADO system tool

--	--	--	--

Compatible products



Accessories

Description	Color	Type	Part Numbers	Pkg qty	Weight (1 pce) g
1 Cable clamps	Beige <input type="checkbox"/>	PT1 PT2	1SSS299253R2800 1SSS299254R2800	20	1.60 4.80
2 Coding pegs	Yellow <input type="checkbox"/>	COCF	1SNA199320R0400	10	1.00
3 Tools		OUPAD OUMAD	1SNA178944R0400 1SNA179466R0600	1	205.00 29.00
4 Terminal block markers	White <input type="checkbox"/>	RB-12W7	1SNA290455R0700	50	6.00

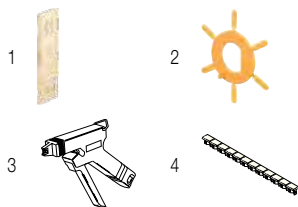

L 276 200 15 female plugs

ADO System® - 7.62 mm 0.3 in spacing



L 276 200 15

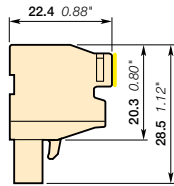
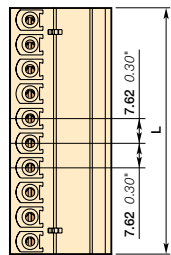

L = nb poles x 7.62

7.62 mm 0.3 in spacing

Description

- With the TE Connectivity ADO System®, experience the fastest and most reliable connection on the market,
- Designed for rolling stock applications exposed to severe constraints (vibrations, shocks etc.),
- Up to 2 wires per connection,
- Yellow marking to identify wire size.

Ordering details

Description	Color	Type	Part Numbers	Pkg qty	Weight (1 pce) g
Female plugs	Beige	FIC F.ADO.T3.4P.NF	1SSS276204R8800	50	13.00
	Beige	FIC F.ADO.T3.5P.NF	1SSS276205R8800	50	16.00

Main technical data

Connecting capacity	NF F 63-808	NF F 63-296 NF F 63-826	EN 50306	Mounting instructions
ADO Flexible without ferrule	4.32 mm²			Rail Tool  ADO system tool
Rated current	24 A	16 A		
Rated short-time withstand current (1s)	518.4 A			
Rated voltage	500 V	500 V		
Impulse withstand voltage				
Protection	IP20			

Compatible products

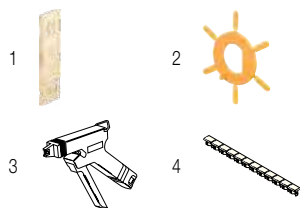

Accessories

Description	Color	Type	Part Numbers	Pkg qty	Weight (1 pce) g
1 Cable clamps	Beige	PT1	1SSS299253R2800	20	1.60
		PT2	1SSS299254R2800	20	4.80
2 Coding pegs	Yellow	COCF	1SNA199320R0400	10	1.00
3 Tools		OUPAD	1SNA178944R0400	1	205.00
		OUMAD	1SNA179466R0600	1	29.00
4 Terminal block markers	White	RB-12W7	1SNA290455R0700	50	6.00

L 366 200 45 male plugs with flanges and inserts

ADO System® - 7.62 mm 0.3 in spacing



1.82 mm²



1SNC167131W0014

L 366 200 45

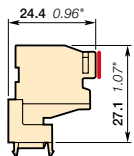
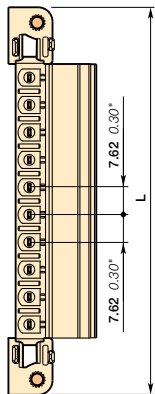

$L = (\text{nb poles} \times 7.62) + 31.5$

7.62 mm 0.3 in spacing

Description

- With the TE Connectivity ADO System®, experience the fastest and most reliable connection on the market,
- Designed for rolling stock applications exposed to severe constraints (vibrations, shocks etc.),
- Up to 2 wires per connection,
- Red marking to identify wire size.

Ordering details

Description	Color	Type	Part Numbers	Pkg qty	Weight (1 pce) g
Male plugs	Beige	FIC M.ADO.T1.FI.2P.NF	1SSS366202R4100	50	
	Beige	FIC M.ADO.T1.FI.3P.NF	1SSS366203R4100	50	
	Beige	FIC M.ADO.T1.FI.4P.NF	1SSS366204R4100	50	
	Beige	FIC M.ADO.T1.FI.5P.NF	1SSS366205R4100	50	
	Beige	FIC M.ADO.T1.FI.6P.NF	1SSS366206R4100	50	
	Beige	FIC M.ADO.T1.FI.8P.NF	1SSS366208R4100	50	
	Beige	FIC M.ADO.T1.FI.10P.NF	1SSS366210R4100	50	

Main technical data

Connecting capacity	NF F 63-808	NF F 63-296 NF F 63-826	EN 50306
ADO Flexible without ferrule	0.6 ... 1.82 mm ²		0.5 ... 1.5 mm ²
Rated current	IEC 16 A	NF F 61-017 16 A	
Rated short-time withstand current (1s)	218.4 A		
Rated voltage	500 V	500 V	
Impulse withstand voltage			
Protection	IP20		

Mounting instructions

Mounting instructions	Tool	ADO system tool
Rail		
Tool		ADO system tool

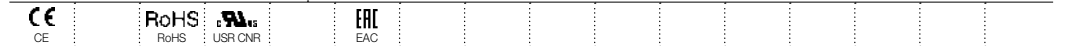

Compatible products



L 266 200 25



L 267 200 25



L 276 200 25

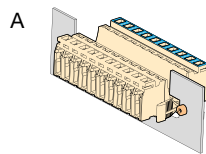

A: Panel feed-through or base mounting

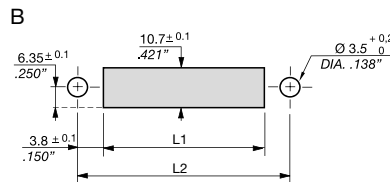

B: Panel feed-through drilling
L1 = (nb poles x 7.62) + 15.24
L2 = (nb poles x 7.62) + 22.86

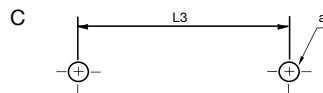

C: Base drilling
L3 = (nb poles x 7.62) + 22.86
a: M2.5 or M3 insert on panel

Accessories

Description	Color	Type	Part Numbers	Pkg qty	Weight (1 pce) g
1 Cable clamps	Beige	PT1	1SSS299253R2800	20	1.60
		PT2	1SSS299254R2800	20	4.80
2 Tools		OUPAD	1SNA178944R0400	1	205.00
		OUMAD	1SNA179466R0600	1	29.00
3 Terminal block markers	White	RB-12W7	1SNA290455R0700	50	6.00

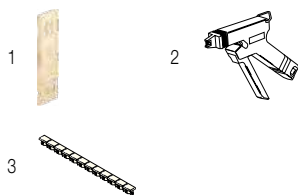

L 367 200 45 male plugs with flanges and inserts

ADO System® - 7.62 mm 0.3 in spacing



L 367 200 45

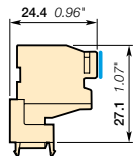
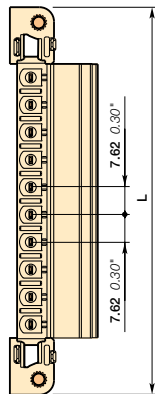

$L = (\text{nb poles} \times 7.62) + 31.5$

7.62 mm 0.3 in spacing

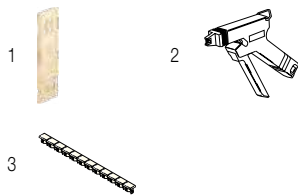

Description

- With the TE Connectivity ADO System®, experience the fastest and most reliable connection on the market,
- Designed for rolling stock applications exposed to severe constraints (vibrations, shocks etc.),
- Up to 2 wires per connection,
- Blue marking to identify wire size.

Ordering details

Description	Color	Type	Part Numbers	Pkg qty	Weight (1 pce) g
Male plugs	2 poles	Beige <input type="checkbox"/> FIC M.ADO.T2.FI.2P.NF	1SSS367202R4100	50	
	3 poles	Beige <input type="checkbox"/> FIC M.ADO.T2.FI.3P.NF	1SSS367203R4100	50	
	4 poles	Beige <input type="checkbox"/> FIC M.ADO.T2.FI.4P.NF	1SSS367204R4100	50	
	5 poles	Beige <input type="checkbox"/> FIC M.ADO.T2.FI.5P.NF	1SSS367205R4100	50	
	6 poles	Beige <input type="checkbox"/> FIC M.ADO.T2.FI.6P.NF	1SSS367206R4100	50	
	8 poles	Beige <input type="checkbox"/> FIC M.ADO.T2.FI.8P.NF	1SSS367208R4100	50	
	10 poles	Beige <input type="checkbox"/> FIC M.ADO.T2.FI.10P.NF	1SSS367210R4100	50	

Main technical data

Connecting capacity	NF F 63-808	NF F 63-296 NF F 63-826	EN 50306
ADO Flexible without ferrule	0.93 ... 2.61 mm²		1 ... 2.5 mm²
Rated current	IEC 22 A	NF F 61-017 16 A	
Rated short-time withstand current (1s)	313.2 A		
Rated voltage	500 V	500 V	
Impulse withstand voltage			
Protection	IP20		

Mounting instructions

Rail		
Tool		ADO system tool

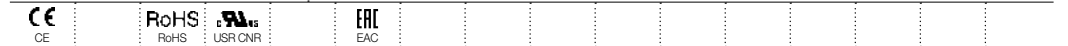

Compatible products

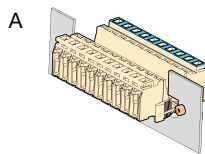

A: Panel feed-through or base mounting

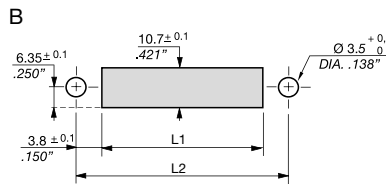

B: Panel feed-through drilling
 $L1 = (\text{nb poles} \times 7.62) + 15.24$
 $L2 = (\text{nb poles} \times 7.62) + 22.86$

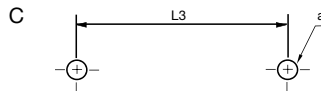

C: Base drilling
 $L3 = (\text{nb poles} \times 7.62) + 22.86$
 a: M2.5 or M3 insert on panel

Accessories

Description	Color	Type	Part Numbers	Pkg qty	Weight (1 pce) g
1 Cable clamps	Beige <input type="checkbox"/>	Used on products from 3 to 7 poles	PT1	1SSS299253R2800	20 1.60
		Used on products from 8 to 16 poles	PT2	1SSS299254R2800	20 4.80
2 Tools		Semi automatic tool	OUPAD	1SNA178944R0400	1 205.00
		Hand tool	OUMAD	1SNA179466R0600	1 29.00
3 Terminal block markers	White <input type="checkbox"/>	Blank strip marker	RB-12W7	1SNA290455R0700	50 6.00

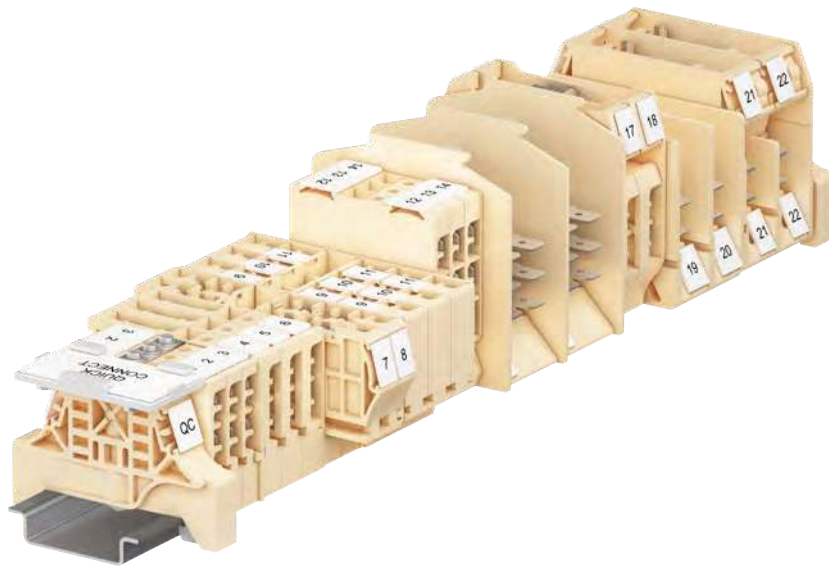

Railway applications, terminal blocks

Quick-connect technology



Technologies presentation		138
Overview		140
With longitudinal quick-connect tabs		
2.5 mm ²	HD2.5/6.2G.2G.1	2 longitudinal tabs on each side 144
6 mm ²	HD6/8.2G.2G.1	2 longitudinal tabs on each side 145
	HD6/8.2G.2G.2	2 longitudinal tabs and 2 vertical tabs 146
	HD6/7.5G	5 vertical tabs 147
	HD6/7.3G.2G	2 circuits-3 vertical tabs with jumper and 2 vertical tabs 148
	HD6/7.2G.3G	2 circuits-3 vertical tabs and 2 vertical tabs with jumper 149
	HD6/9.5G	5 vertical tabs 150
	HD6/9.3G.2G	2 circuits-3 vertical tabs with jumper and 2 vertical tabs 151
	HD6/9.2G.3G	2 circuits-3 vertical tabs and 2 vertical tabs with jumper 152
Stud-quick-connect		
35 mm ²	HD6/22.F12G	1 M6 stud - 12 quick-connect tabs 153
	HD6/30.F12G	1 M6 stud - 12 quick-connect tabs 154
Fuse holder		
6 mm ²	HD6/14.SF.2G.2G	for 5x20mm fuses 155
Component holder		
6 mm ²	HD6/24.DH	For screw and solder diode-6 tabs 156
	HD6/24.DH	For screw and solder diode-8 tabs 156
	HD6/14.DH	For screw and solder diode-2 tabs on each side 157
	HD6/14.DG	For solder diode or resistor-2 tabs on each side 158
	HD6/9.SDH.1	Disconnect with component holder plug 159
	HD6/14.SDH.1	Disconnect with component holder plug for screw & solder diode 160
	HD6/14.SDH	Disconnect with component holder plug for screw & solder diode type SKN2.5 or SKNa2 161
Multi level longitudinal quick-connect tabs		
2.5 mm ²	HD2.5/6.3.3G.3G.1	1 circuit - 6 tabs 162
	HD2.5/6.3.2G.2G.1.GG	Top circuit with 4 tabs - Bottom circuit with 2 tabs 163
	HD2.5/6.3.GG1.2G.2G	Top circuit with 2 tabs - Bottom circuit with 4 tabs 164
	HD2.5/6.3.GG.1.2GG	3 circuits - 1 tab each side 165
	HD2.5/6.3.2G.2G.1	1 Top circuit with 4 tabs 166
	HD2.5/6.3.GH.2G.H	1 top circuit with 1 tab & 1 solder connection - 1 bottom circuit with 2 tabs & 1 solder connection 167

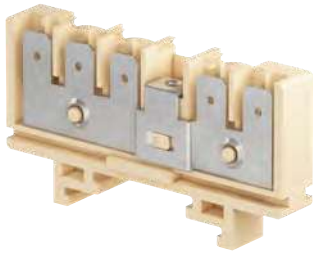

The historical technology for railway control and signal distribution

The Quick-connect technology allows to save wiring time and is a good solution for distribution of control signal. It can be used in case of limited space on the side (vertical version), when a high density connection is needed (horizontal version up to 6 connection per block) or when the power has to be distributed from power to control circuits (1 stud input / 12 quick-connect outputs).



Reliable in harsh conditions

Continuous operation guaranteed for rolling stock

- Environmental tests: aging, corrosion, flammability, toxicity (I2F2, V0, HL3 R22)
- Mechanical tests: vibration and shock.



Improve installation efficiency

Large and flexible offering

- Top or side connection
- Up to 6 connections in 1 block
- Easy distribution thanks to hybrid versions with both fast-on and stud connections
- Circuit protection thanks to component holder.

Features

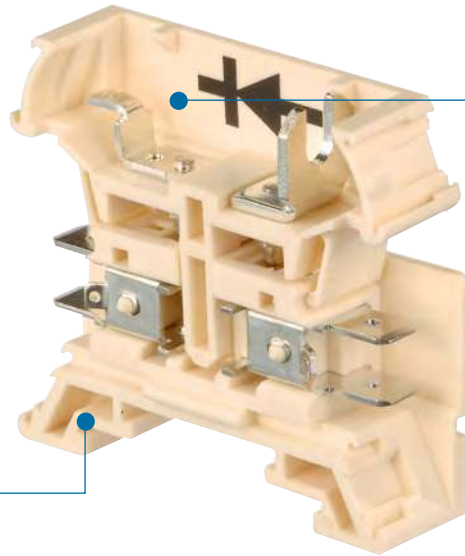

Area dedicated to component soldering and screwing (SKN diodes or resistors)

Compatible with both CCTU and DIN3 rails

High density power distribution (35 mm² / 155 A)



Control circuits (2.5 mm² / 16 A)

Railway applications, terminal blocks

Quick-connect technology

Range overview from 2.5 up to 6 mm²

Feed-through
From 2.5 to 6 mm²

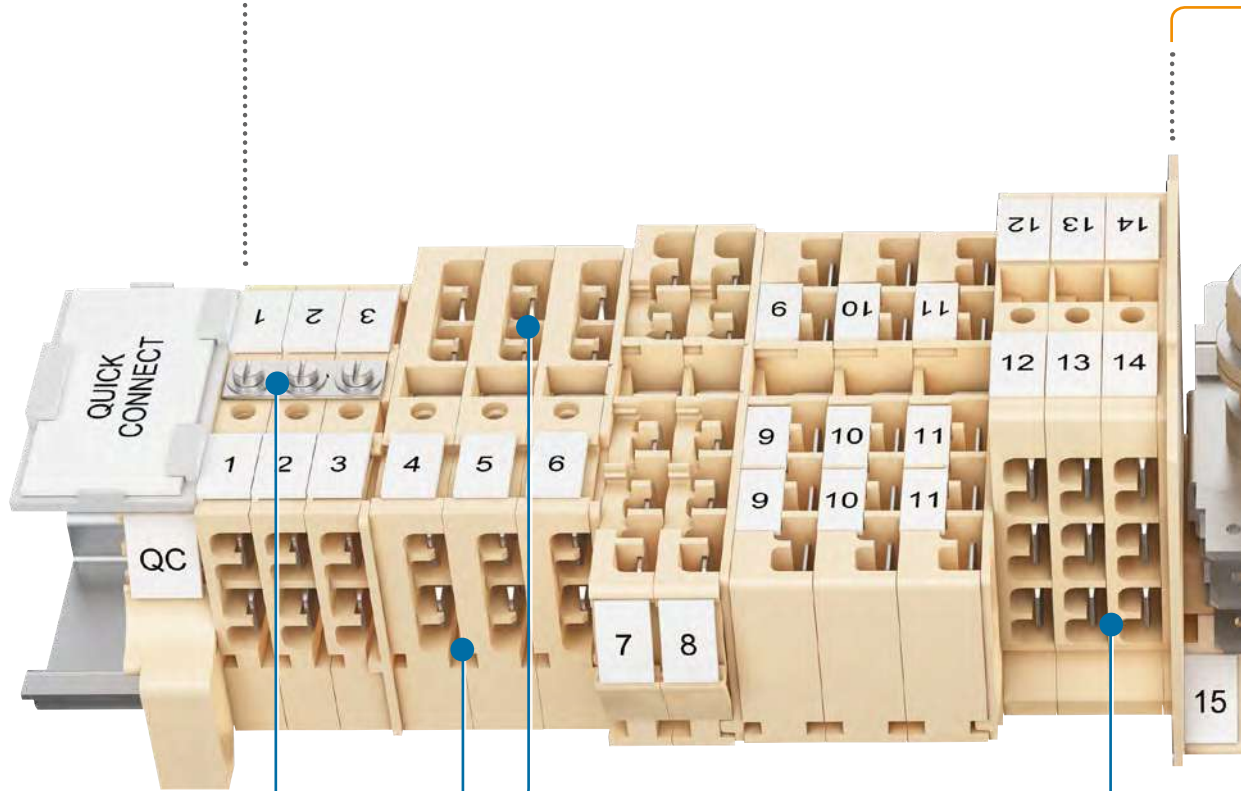

Perforated jumpering bars
Easy to install by cutting out the precut partitions

Top or side connection
Flexibility of the connection angle

High connection density
Up to 6 connections in 6 mm spacing

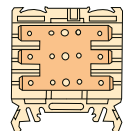
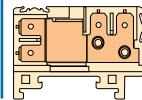

Distribution

35 mm² / 2.5 mm²

Component holder

From 2.5 to 6 mm²

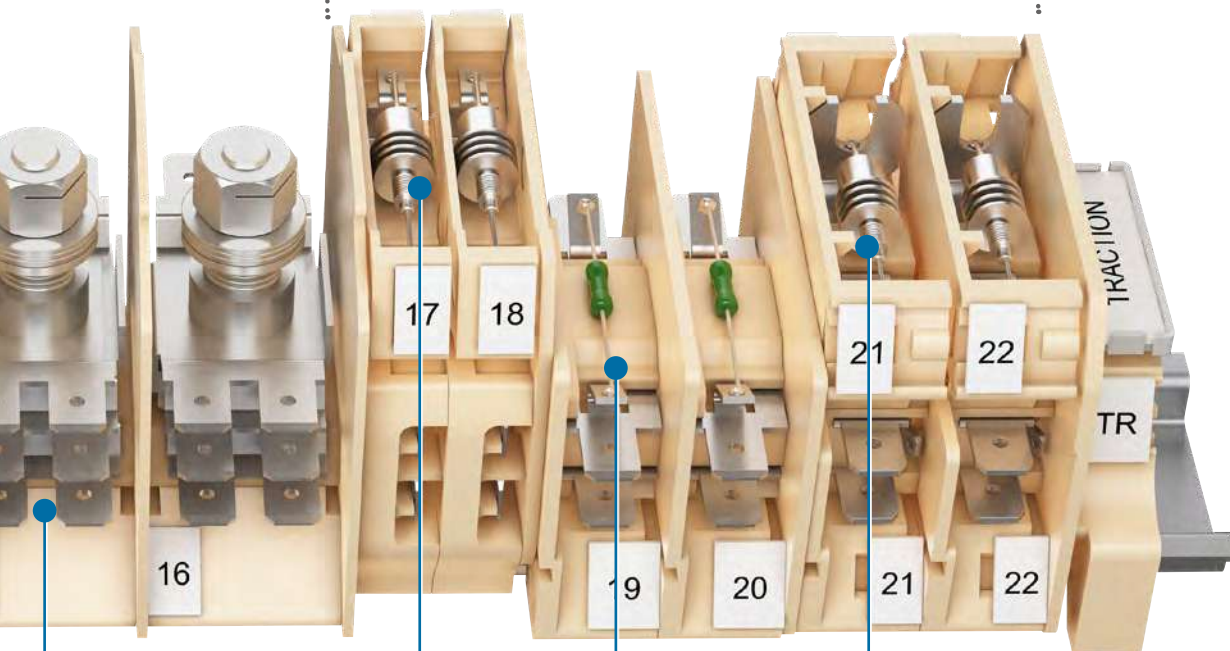

**Easy distribution
of up to 12 outputs**

With quick-connect / stud
hybrid terminal blocks



Component holders

Easy to solder diodes or resistors
for circuit protection

Railway applications, terminal blocks

Quick-connect technology

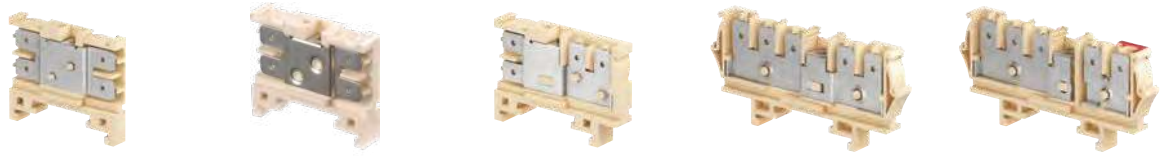
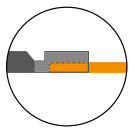

Feed-through

7 mm spacing

Section					
2.5 mm ²	HD2.5/6.2G.2G.1	HD6/8.2G.2G.1	HD6/8.2G.2G.2	HD6/7.5G	HD6/7.3G.2G
6 mm ²					



Stud-quick-connect

Fuse holder

Section				
6 mm ²			HD6/14.SF2G.2G	HD6/24.DH
35 mm ² / 2.5 mm ²	HD6/22.F12G			
35 mm ² / 6 mm ²		HD6/30.F12G		



Multi level longitudinal quick-connect tabs-Feed-through

Section				
2.5 mm ²	HD2.5/6.3.3G.3G.1	HD2.5/6.3.2G.2G.1.GG	HD2.5/6.3.GG1.2G.2G	HD2.5/6.3.GG.1.2GG

Clamp -
 Channels for jumpering or testing -
 Test socket -
 Blown-fuse indicator

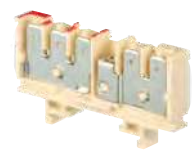
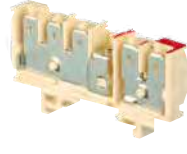
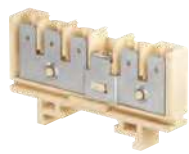
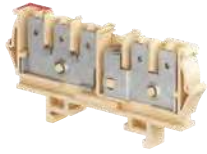
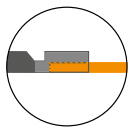

9 mm spacing



HD6/7.2G.3G



HD6/9.5G



HD6/9.3G.2G



HD6/9.2G.3G

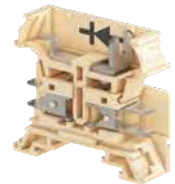
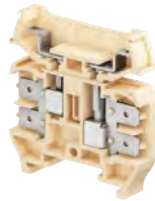

Component holder



HD6/14.DH



HD6/14.DG



HD6/9.SDH.1



HD6/14.SDH.1



HD6/14.SDH



HD2.5/6.3.2G.2G.1



HD2.5/6.3.GH.2G.H

HD2.5/6.2G.2G.1 Quick connect terminal blocks

Feed-through - 6 mm 0.236 in spacing

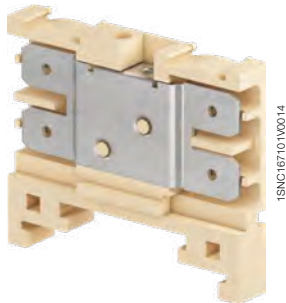

HD2.5/6.2G.2G.1

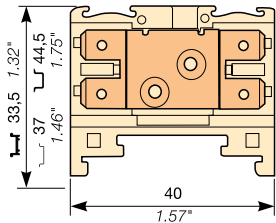

6 mm 0.236 in spacing

Description

- Connection by 2 longitudinal tabs for quick-connect 6.3 x 0.8 mm 0.248 x 0.031 in on each side,
- Possibility of testing,
- Two jumpering options: 6 mm 0.236 in spacing with BJS61 and 7 mm 0.276 in (adding end section) with BJH7,
- Use of jumper bars requires to cut out the precut partition,
- NF F 61-017 designation: BB0006-2G2G (1SNA160487R2500) or BB0007-2G2G (1SNA160487R2500 + FEH3).

Ordering details

Description	Color	Type	Part Numbers	Pkg qty	Weight (1 pce) g
4 tabs 1 circuit	Beige	HD2.5/6.2G.2G.1	1SNA160487R2500	50	7.00

Main technical data

Connecting capacity	NF C	DIN	NF F 61-017	Mounting instructions
1 conductor per clamp Quick-connect: 6.3 x 0.8 mm	0.34 ... 2.5 mm ²			Rail Type 2, TH 35-7.5, TH 35-15
Rated voltage V AC	(Cat. C) 250 V	(Cat. C) 125 V	250 V	
V DC	(Cat. C) 250 V	(Cat. C) 150 V	250 V	
Rated current	25 A	26 A	20 A	
Rated cross section	2.5 mm ²	2.5 mm ²		

--	--	--	--	--	--	--	--	--	--

Accessories

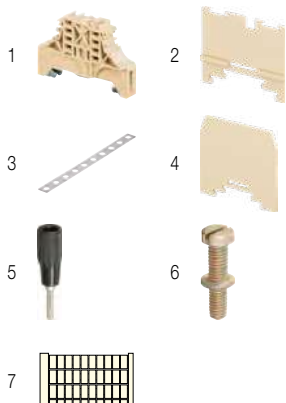

Description	Color	Type	Part Numbers	Pkg qty	Weight (1 pce) g
1 End stops 10 mm 0.394 in	Beige	BAM2	1SNA296351R0000	50	12.00
10.7 mm 0.421 in		BAH24	1SNA168355R1300	50	12.00
2 End sections 1 mm 0.039 in	Beige	FEH3	1SNA198352R0700	20	1.10
3 Jumper bars 2 poles 32 A (IEC)		BJS61-2	1SNA168481R2300	10	1.80
3 poles 32 A (IEC)		BJS61-3	1SNA168482R2400	10	1.80
4 poles 32 A (IEC)		BJS61-4	1SNA168483R2500	10	1.80
5 poles 32 A (IEC)		BJS61-5	1SNA168484R2600	10	1.80
10 poles 32 A (IEC)		BJS61-10	1SNA168485R2700	10	2.00
2 poles		BJH7-2	1SNA168486R2000	10	0.50
3 poles		BJH7-3	1SNA168487R2100	10	0.80
10 poles		BJH7-10	1SNA168490R0000	10	3.00
4 Circuit separators 1.6 mm 0.063 in	Beige	SCH3	1SNA198692R2500	10	4.30
5 Test plugs DIA 2 mm 0.079 in	Black	FC2	1SNA007865R2600	100	2.00
6 Fastening kits Screw M2.5x5 for jumper bar BJH		VSJ6	1SNA167735R2700	1	
Washer for screw VSJ		RDJ6	1SNA173241R0600	1000	0.10
7 Terminal block markers Blank card	White	RC610	1SNA233000R0100	10	7.50

HD6/8.2G.2G.1 Quick connect terminal blocks

Feed-through - 8 mm 0.315 in spacing

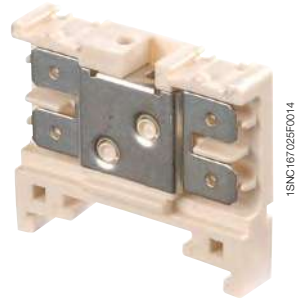

HD6/8.2G.2G.1

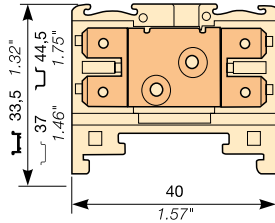

8 mm 0.315 in spacing

Description

- Connection by 2 longitudinal tabs for quick-connect 6.3 x 0.8 mm 0.248 x .031 in on each side,
- Possibility of testing,
- Two jumpering options: 8 mm 0.315 in spacing with BJH8 and 9 mm 0.354 in spacing (adding end section) with BJH9,
- Use of jumper bars requires to cut out the precut partition,
- NF F 61-017 designation: BB0008-2G2G (1SNA160606R1400) or BB0009-2G2G (1SNA160606R1400 + FEH3).

Ordering details

Description	Color	Type	Part Numbers	Pkg qty	Weight (1 pce) g
4 tabs 1 circuit	Beige <input type="checkbox"/>	HD6/8.2G.2G.1	1SNA160606R1400	50	8.00

Main technical data

Connecting capacity	NF C	DIN	NF F 61-017	Mounting instructions
1 conductor per clamp Quick-connect: 6.3 x 0.8 mm	0.34 ... 6 mm ²			Rail Type 2, TH 35-7.5, TH 35-15
Rated voltage	V AC (Cat. C) 250 V	(Cat. C) 250 V	250 V	
	V DC (Cat. C) 250 V	(Cat. C) 300 V	250 V	
Rated current	25 A	26 A	20 A	
Rated cross section	6 mm ²	6 mm ²		

--	--	--	--	--	--	--	--	--	--

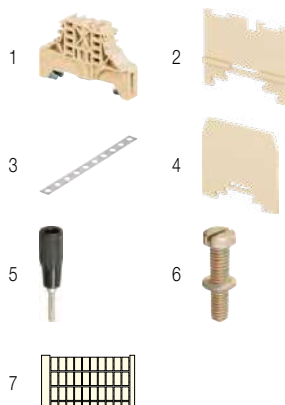

Accessories

Description	Color	Type	Part Numbers	Pkg qty	Weight (1 pce) g
1 End stops	Beige <input type="checkbox"/>	BAM2	1SNA296351R0000	50	12.00
		BAH24	1SNA168355R1300	50	12.00
2 End sections	Beige <input type="checkbox"/>	FEH3	1SNA198352R0700	20	1.10
3 Jumper bars		BJH8-2	1SNA168456R0100	10	0.60
		BJH8-3	1SNA168457R0200	10	0.90
		BJH8-4	1SNA168458R1300	10	1.30
		BJH8-5	1SNA168459R1400	10	1.60
		BJH8-10	1SNA168356R1400	10	3.40
		BJH9-2	1SNA168460R1100	10	1.60
		BJH9-3	1SNA168461R0600	10	1.00
		BJH9-4	1SNA168462R0700	10	1.40
		BJH9-5	1SNA168463R0000	10	1.80
		BJH9-10	1SNA168357R1500	10	3.80
4 Circuit separators	Beige <input type="checkbox"/>	SCH3	1SNA198692R2500	10	4.30
5 Test plugs	Black <input type="checkbox"/>	FC2	1SNA007865R2600	100	2.00
6 Fastening kits		VSJ6	1SNA167735R2700	1	
		RDJ6	1SNA173241R0600	1000	0.10
7 Terminal block markers	White <input type="checkbox"/>	RC610	1SNA233000R0100	10	7.50
		RC810	1SNA234000R0200	10	8.20

HD6/8.2G.2G.2 Quick connect terminal blocks

Feed-through - 8 mm 0.315 in spacing



6 mm²

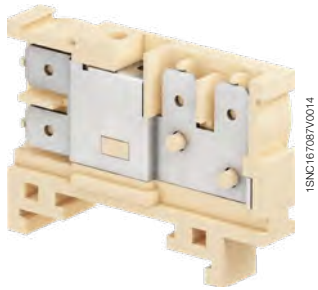

1SNC1670870014

HD6/8.2G.2G.2



8 mm 0.315 in spacing

Description

- Connection by 2 longitudinal tabs on one side and 2 vertical tabs on the other side for quick-connect 6.3 x 0.8 mm 0.248 x 0.031 in,
- Possibility of testing and transverse connection,
- Use of jumper bars requires to cut out the precut partition.

Ordering details

Description	Color	Type	Part Numbers	Pkg qty	Weight (1 pce)
4 tabs 1 circuit	Beige <input type="checkbox"/>	HD6/8.2G.2G.2	1SNA160619R1000	50	11.00

Main technical data

Connecting capacity	NF C	DIN	NF F 61-017	Mounting instructions
1 conductor per clamp	Quick-connect: 6.3 x 0.8 mm	0.34 ... 6 mm ²		Rail Type 2, TH 35-7.5, TH 35-15
Rated voltage	V AC	(Cat. C) 400 V	(Cat. C) 380 V	380 V
	V DC	(Cat. C) 250 V	(Cat. C) 450 V	380 V
Rated current		25 A	26 A	20 A
Rated cross section		6 mm ²	6 mm ²	

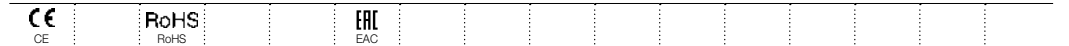

Accessories

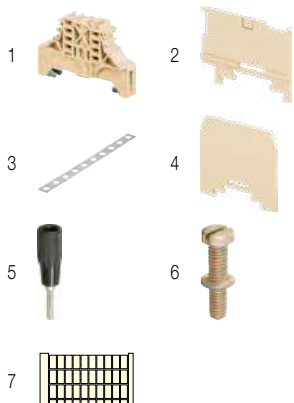

Description	Color	Type	Part Numbers	Pkg qty	Weight (1 pce)
1 End stops	Beige <input type="checkbox"/>	BAM2	1SNA296351R0000	50	12.00
		BAH24	1SNA168355R1300	50	12.00
2 End sections	Beige <input type="checkbox"/>	FEH4	1SNA193878R2200	20	1.80
3 Jumper bars		BJH8-2	1SNA168456R0100	10	0.60
		BJH8-3	1SNA168457R0200	10	0.90
		BJH8-4	1SNA168458R1300	10	1.30
		BJH8-5	1SNA168459R1400	10	1.60
		BJH8-10	1SNA168356R1400	10	3.40
4 Circuit separators	Beige <input type="checkbox"/>	SCH3	1SNA198692R2500	10	4.30
5 Test plugs	Black <input type="checkbox"/>	FC2	1SNA007865R2600	100	2.00
6 Fastening kits		VSJ6	1SNA167735R2700	1	
		RDJ6	1SNA173241R0600	1000	0.10
7 Terminal block markers	White <input type="checkbox"/>	RC610	1SNA233000R0100	10	7.50
		RC810	1SNA234000R0200	10	8.20

HD 6/7.5G Quick connect terminal blocks

Feed-through - 7 mm 0.276 in spacing



6 mm²

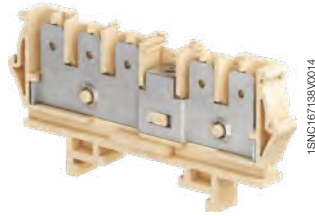

1SNC167138V0014

HD 6/7.5G

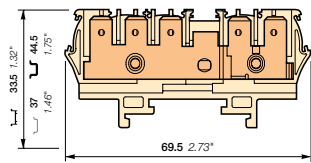

7 mm 0.276 in spacing

Description

- Connection by 5 vertical tabs for quick-connect 6.3 x 0.8 mm 0.248 x 0.031 in,
- Possibility of transverse connection,
- Use of jumper bars requires to cut out the precut partition.

Ordering details

Description	Color	Type	Part Numbers	Pkg qty	Weight (1 pce) g
5 tabs 1 circuit	Beige <input type="checkbox"/>	HD6/7.5G	1SNA400766R1500	25	

Main technical data

Connecting capacity	NF C	DIN	NF F 61-017	Rail	Mounting instructions
1 conductor per clamp Quick-connect: 6.3 x 0.8 mm	0.34 ... 6 mm ²				Type 2, TH 35-7.5, TH 35-15
Rated voltage	V AC	320 V	320 V	320 V	
	V DC	320 V	320 V	320 V	
Rated current		25 A	25 A	20 A	
Rated cross section		6 mm ²	6 mm ²		

Mounting instructions

--	--	--	--	--	--	--	--	--	--	--

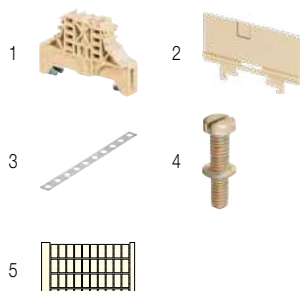

Accessories

Description	Color	Type	Part Numbers	Pkg qty	Weight (1 pce) g
1 End stops	Beige <input type="checkbox"/>	10 mm 0.394 in	BAM2	1SNA296351R0000	50 12.00
		10.7 mm 0.421 in	BAH24	1SNA168355R1300	50 12.00
2 End sections	Beige <input type="checkbox"/>	1 mm 0.039 in	FEHD1	1SNA199400R0600	20 2.00
3 Jumper bars		2 poles	BJH7-2	1SNA168486R2000	10 0.50
		3 poles	BJH7-3	1SNA168487R2100	10 0.80
		10 poles	BJH7-10	1SNA168490R0000	10 3.00
4 Fastening kits		Screw M2.5X5 for jumper bar BJH	VSJ6	1SNA167735R2700	1
		Washer for screw VSJ	RDJ6	1SNA173241R0600	1000 0.10
5 Terminal block markers	White <input type="checkbox"/>	Blank card	RC610	1SNA233000R0100	10 7.50

5

1SNC167054S0201

HD 6/7.3G.2G Quick connect terminal blocks

Feed-through - 7 mm 0.276 in spacing

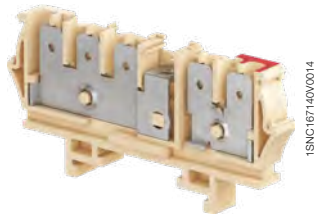

HD 6/7.3G.2G

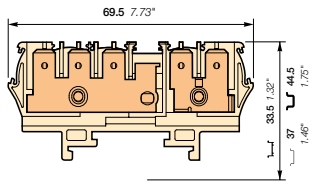

7 mm 0.276 in spacing

Description

- 2 circuits: 1 circuit with 3 vertical tabs for quick-connect 6.3 x 0.8 mm 0.248 x 0.031 in, possibility of transverse connection and 1 circuit with 2 vertical tabs for quick-connect 6.3 x 0.8 mm 0.248 x 0.031 in, marked in red,
- Use of jumper bars requires to cut out the precut partition.

Ordering details

Description	Color	Type	Part Numbers	Pkg qty	Weight (1 pce) g
5 tabs 2 circuits	Beige <input type="checkbox"/>	HD6/7.3G.2G	1SNA400767R1600	25	

Main technical data

Connecting capacity	NF C	DIN	NF F 61-017	Rail	Type 2, TH 35-7.5, TH 35-15
1 conductor per clamp Quick-connect: 6.3 x 0.8 mm	0.34 ... 6 mm ²				
Rated voltage	V AC	320 V	320 V	320 V	
	V DC	320 V	320 V	320 V	
Rated current		25 A	25 A	20 A	
Rated cross section		6 mm ²	6 mm ²		

Mounting instructions

--	--	--	--	--	--

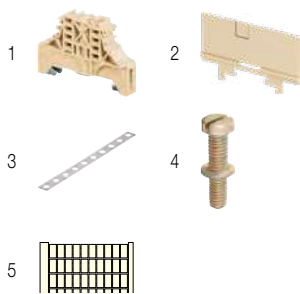

Accessories

Description	Color	Type	Part Numbers	Pkg qty	Weight (1 pce) g	
1 End stops	Beige <input type="checkbox"/>	BAM2	1SNA296351R0000	50	12.00	
		BAH24	1SNA168355R1300	50	12.00	
2 End sections	Beige <input type="checkbox"/>	FEHD1	1SNA199400R0600	20	2.00	
3 Jumper bars		2 poles	BJH7-2	1SNA168486R2000	10	0.50
		3 poles	BJH7-3	1SNA168487R2100	10	0.80
		10 poles	BJH7-10	1SNA168490R0000	10	3.00
4 Fastening kits		Screw M2.5x5 for jumper bar BJH	VSJ6	1SNA167735R2700	1	
		Washer for screw VSJ	RDJ6	1SNA173241R0600	1000	0.10
5 Terminal block markers	White <input type="checkbox"/>	RC610	1SNA233000R0100	10	7.50	

HD 6/7.2G.3G Quick connect terminal blocks

Feed-through - 7 mm 0.276 in spacing



6 mm²

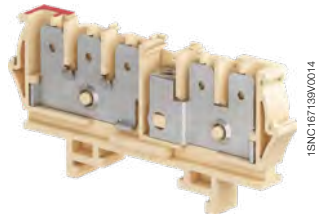

1SNC167139W0014

HD 6/7.2G.3G

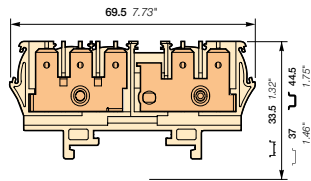

7 mm 0.276 in spacing

Description

- 2 circuits: 1 circuit with 3 vertical tabs for quick-connect 6.3 x 0.8 mm 0.248 x 0.031 in, marked in red and 1 circuit with 2 vertical tabs for quick-connect 6.3 x 0.8 mm 0.248 x 0.031 in, possibility of transverse connection,
- Use of jumper bars requires to cut out the precut partition.

Ordering details

Description	Color	Type	Part Numbers	Pkg qty	Weight (1 pce) g
5 tabs 2 circuits	Beige <input type="checkbox"/>	HD6/7.2G.3G	1SNA400768R2700	25	

Main technical data

Connecting capacity	NF C	DIN	NF F 61-017	Rail	Mounting instructions
1 conductor per clamp	Quick-connect: 6.3 x 0.8 mm	0.34 ... 6 mm ²			Type 2, TH 35-7.5, TH 35-15
Rated voltage	V AC	320 V	320 V	320 V	
	V DC	320 V	320 V	320 V	
Rated current		25 A	25 A	20 A	
Rated cross section		6 mm ²	6 mm ²		

<input type="checkbox"/> CE	<input type="checkbox"/> RoHS	<input type="checkbox"/> EAC																		
-----------------------------	-------------------------------	------------------------------	--	--	--	--	--	--	--	--	--	--	--	--	--	--	--	--	--	--

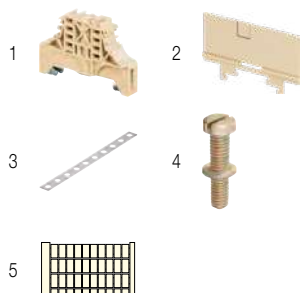

Accessories

Description	Color	Type	Part Numbers	Pkg qty	Weight (1 pce) g	
1 End stops	Beige <input type="checkbox"/>	BAM2	1SNA296351R0000	50	12.00	
		BAH24	1SNA168355R1300	50	12.00	
2 End sections	Beige <input type="checkbox"/>	FEHD1	1SNA199400R0600	20	2.00	
3 Jumper bars		2 poles	BJH7-2	1SNA168486R2000	10	0.50
		3 poles	BJH7-3	1SNA168487R2100	10	0.80
		10 poles	BJH7-10	1SNA168490R0000	10	3.00
4 Fastening kits		Screw M2.5X5 for jumper bar BJH	VSJ6	1SNA167735R2700	1	
		Washer for screw VSJ	RDJ6	1SNA173241R0600	1000	0.10
5 Terminal block markers	White <input type="checkbox"/>	RC610	1SNA233000R0100	10	7.50	

HD6/9.5G Quick connect terminal blocks

Feed-through - 9 mm 0.354 in spacing

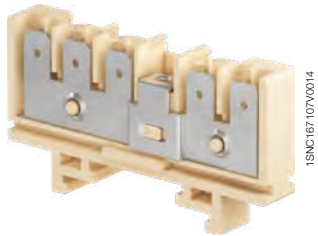

HD6/9.5G

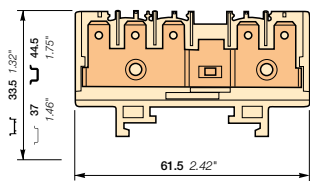

9 mm 0.354 in spacing

Description

- Connection by 5 vertical tabs for quick-connect 6.3 x 0.8 mm 0.248 x 0.031 in,
- Possibility of testing and transverse connection,
- Use of jumper bars requires to cut out the precut partition,
- NF F 61-017 designation: BC0009-3G2G (1SNA160621R0200).

Ordering details

Description	Color	Type	Part Numbers	Pkg qty	Weight (1 pce)
5 tabs 1 circuit	Beige <input type="checkbox"/>	HD6/9.5G	1SNA160621R0200	25	13.00

Main technical data

Connecting capacity	NF C	DIN	NF F 61-017	Rail	Mounting instructions
1 conductor per clamp Quick-connect: 6.3 x 0.8 mm	0.34 ... 6 mm ²				Type 2, TH 35-7.5, TH 35-15
Rated voltage	V AC (Cat. C) 400 V	(Cat. C) 380 V	380 V		
	V DC (Cat. C) 250 V	(Cat. C) 450 V	380 V		
Rated current	25 A	26 A	20 A		
Rated cross section	6 mm ²	6 mm ²			

--	--	--	--	--	--	--	--	--	--

Accessories

Description	Color	Type	Part Numbers	Pkg qty	Weight (1 pce)	
1 End stops 10 mm 0.394 in	Beige <input type="checkbox"/>	BAM2	1SNA296351R0000	50	12.00	
2 End sections 10.7 mm 0.421 in	Beige <input type="checkbox"/>	BAH24	1SNA168355R1300	50	12.00	
3 Jumper bars 1 mm 0.039 in	Beige <input type="checkbox"/>	FEHD1	1SNA199400R0600	20	2.00	
3 Jumper bars		2 poles	BJH9-2	1SNA168460R1100	10	1.60
		3 poles	BJH9-3	1SNA168461R0600	10	1.00
		4 poles	BJH9-4	1SNA168462R0700	10	1.40
		5 poles	BJH9-5	1SNA168463R0000	10	1.80
		10 poles	BJH9-10	1SNA168357R1500	10	3.80
4 Test plugs DIA 2 mm 0.079 in	Black <input type="checkbox"/>	FC2	1SNA007865R2600	100	2.00	
5 Fastening kits		Screw M2.5x5 for jumper bar BJH	V SJ6	1SNA167735R2700	1	
		Washer for screw VSJ	RDJ6	1SNA173241R0600	1000	0.10
6 Terminal block markers Blank card	White <input type="checkbox"/>	RC510	1SNA231000R0700	10	5.20	

HD6/9.3G.2G Quick connect terminal blocks

Feed-through - 9 mm 0.354 in spacing

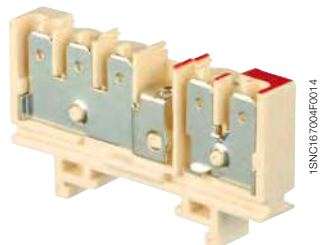

HD6/9.3G.2G

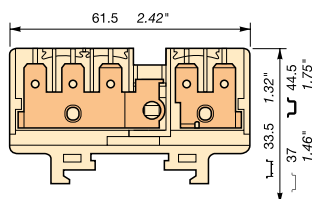

9 mm 0.354 in spacing

Description

- 2 circuits: 1 circuit with 3 vertical tabs for quick-connect 6.3 x 0.8 mm 0.248 x 0.031 in, possibility of testing and transverse connection and 1 circuit with 2 vertical tabs for quick-connect 6.3 x 0.8 mm 0.248 x 0.031 in, marked in red,
- Use of jumper bars requires to cut out the precut partition,
- NF F 61-017 designation: BK0009-3Ge/2G (1SNA160563R0000).

Ordering details

Description	Color	Type	Part Numbers	Pkg qty	Weight (1 pce) g
5 tabs 2 circuits	Beige <input type="checkbox"/>	HD6/9.3G.2G	1SNA160563R0000	25	13.00

Main technical data

Connecting capacity	NF C	DIN	NF F 61-017	Mounting instructions
1 conductor per clamp Quick-connect: 6.3 x 0.8 mm	0.34 ... 6 mm ²			Rail Type 2, TH 35-7.5, TH 35-15
Rated voltage	V AC	(Cat. C) 400 V	(Cat. C) 380 V	380 V
	V DC	(Cat. C) 250 V	(Cat. C) 450 V	380 V
Rated current		25 A	26 A	20 A
	Rated cross section	6 mm ²	6 mm ²	

--	--	--	--	--	--	--	--	--	--	--	--	--	--	--	--	--	--	--	--

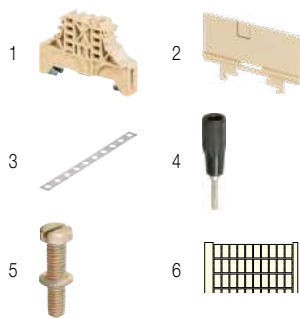

Accessories

Description	Color	Type	Part Numbers	Pkg qty	Weight (1 pce) g	
1 End stops	Beige <input type="checkbox"/>		BAM2	1SNA296351R0000	50 12.00	
			BAH24	1SNA168355R1300	50 12.00	
2 End sections	Beige <input type="checkbox"/>		FEHD1	1SNA199400R0600	20 2.00	
3 Jumper bars			2 poles	BJH9-2	1SNA168460R1100	10 1.60
			3 poles	BJH9-3	1SNA168461R0600	10 1.00
			4 poles	BJH9-4	1SNA168462R0700	10 1.40
			5 poles	BJH9-5	1SNA168463R0000	10 1.80
			10 poles	BJH9-10	1SNA168357R1500	10 3.80
4 Test plugs	Black <input type="checkbox"/>		FC2	1SNA007865R2600	100 2.00	
5 Fastening kits			Screw M2.5X5 for jumper bar BJH	V SJ6	1SNA167735R2700	1
			Washer for screw V SJ	RDJ6	1SNA173241R0600	1000 0.10
6 Terminal block markers	White <input type="checkbox"/>		RC510	1SNA231000R0700	10 5.20	

1SNC167077S0201

HD6/9.2G.3G Quick connect terminal blocks

Feed-through - 9 mm 0.354 in spacing



6 mm²

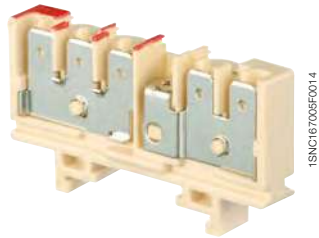

1SNC16700DF0014

HD6/9.2G.3G

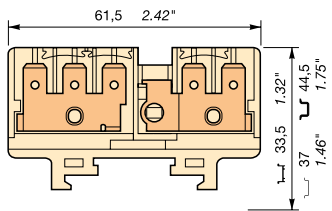

9 mm 0.354 in spacing

Description

- 2 circuits: 1 circuit with 3 vertical tabs for quick-connect 6.3 x 0.8 mm 0.248 x 0.031 in, marked in red and 1 circuit with 2 vertical tabs for quick-connect 6.3 x 0.8 mm 0.248 x 0.031 in, possibility of testing and transverse connection,
- Use of jumper bars requires to cut out the precut partition,
- NF F 61-017 designation: BK0009-3G/2Ge (1SNA160564R0100).

Ordering details

Description	Color	Type	Part Numbers	Pkg qty	Weight (1 pce) g
5 tabs 2 circuits	Beige <input type="checkbox"/>	HD6/9.2G.3G	1SNA160564R0100	25	13.00

Main technical data

Connecting capacity	NF C	DIN	NF F 61-017
1 conductor per clamp Quick-connect: 6.3 x 0.8 mm	0.34 ... 6 mm ²		
Rated voltage	V AC	(Cat. C) 400 V	(Cat. C) 380 V
	V DC	(Cat. C) 250 V	(Cat. C) 450 V
Rated current		25 A	26 A
		6 mm ²	6 mm ²
Rated cross section			

Mounting instructions

Rail	Type 2, TH 35-7.5, TH 35-15

--	--	--	--	--	--	--	--	--	--

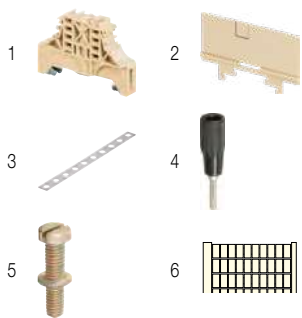

Accessories

Description	Color	Type	Part Numbers	Pkg qty	Weight (1 pce) g
1 End stops	Beige <input type="checkbox"/>	BAM2	1SNA296351R0000	50	12.00
		BAH24	1SNA168355R1300	50	12.00
2 End sections	Beige <input type="checkbox"/>	FEHD1	1SNA199400R0600	20	2.00
3 Jumper bars		BJH9-2	1SNA168460R1100	10	1.60
		BJH9-3	1SNA168461R0600	10	1.00
		BJH9-4	1SNA168462R0700	10	1.40
		BJH9-5	1SNA168463R0000	10	1.80
		BJH9-10	1SNA168357R1500	10	3.80
4 Test plugs	Black <input type="checkbox"/>	FC2	1SNA007865R2600	100	2.00
5 Fastening kits		V SJ6	1SNA167735R2700	1	
		RDJ6	1SNA173241R0600	1000	0.10
6 Terminal block markers	White <input type="checkbox"/>	RC510	1SNA231000R0700	10	5.20

HD6/22.F12G stud terminal blocks

Feed-through - 22 mm 0.866 in spacing



35 mm²



1SNC167089M001.4

HD6/22.F12G

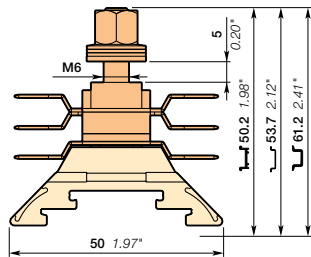

22 mm 0.866 in spacing

Description

- 115 A main circuit: 1 stud terminal M6 x 31.5 mm 1.24 in,
- Equipment: H 130 self locking nut + TREP 3L washer + washer,
- Branch by 12 tabs for quick-connect 6.3 x 0.8 mm 0.248 x 0.031 in: 16 A maximum per tab,
- NF F 61-017 designation: BF0025-1F12G.

Ordering details

Description	Color	Type	Part Numbers	Pkg qty	Weight (1 pce) g
1 stud M6 and 12 tabs 1 circuit	Beige <input type="checkbox"/>	HD6/22.F12G	1SNA400782R0000	10	55.00

Main technical data

Connecting capacity	NF C	DIN	NF F 61-017	Rail	Tool	Type 2, TH 35-7.5, TH 35-15
Wire size	Lug (NF C 20-130)	1.5 ... 35 mm ²				Wrench
	Lug (DIN 46235 / 46234)	2.5 ... 35 mm ²				Ø 10 mm
	Quick-connect: 6.3 x 0.8 mm	0.34 ... 2.5 mm ²				Ø 0.394 in
Rated voltage	V AC		400 V	Torque		5.3 N.m
	V DC		500 V			
Rated current			115/16 A			46.9 lb.in
Rated cross section		35 mm ²				

Mounting instructions

CE	RoHS	ERC	EAC
<input type="checkbox"/>	<input type="checkbox"/>	<input type="checkbox"/>	<input type="checkbox"/>

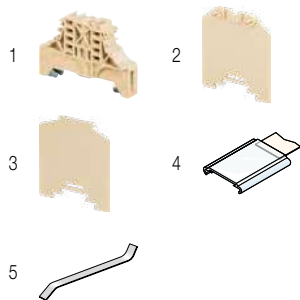

Accessories

Description	Color	Type	Part Numbers	Pkg qty	Weight (1 pce) g
1 End stops	Beige <input type="checkbox"/>	BAM2	1SNA296351R0000	50	12.00
		BAH22	1SNA164655R0400	50	10.00
2 End sections	Beige <input type="checkbox"/>	FJH501	1SNA199411R1400	25	6.50
3 Circuit separators	Beige <input type="checkbox"/>	SCH8	1SNA199412R1500	25	4.80
4 Protecting covers	Transparent <input checked="" type="checkbox"/>	CPM	1SNA187312R1400	1	25.00
		CPM	1SNA197312R1600	10	25.00
5 Terminal block markers	White <input type="checkbox"/>	RTC	1SNA163156R2700	1	10.00
		PEFH	1SNA163497R1600	10	12.00
		RPED	1SNA163518R2200	1	12.00
		RC610	1SNA233000R0100	10	7.50

1SNC167036S0201

HD6/30.F12G stud terminal blocks

Feed-through - 30 mm 1.18 in spacing



HD6/30.F12G

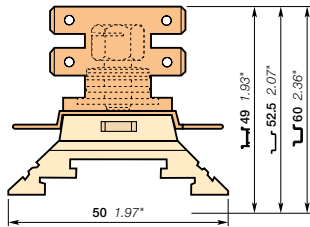

30 mm 1.18 in spacing

Description

- 155 A main circuit: 1 stud terminal M6 x 19.5 mm 0.768 in,
- Equipment: H 130 self locking nut + TREP 3L washer + washer,
- Branch by 12 tabs for quick-connect 6.3 x 0.8 mm 0.248 x 0.031 in: 16 A maximum per tab,
- NF F 61-017 designation: BF31.2-1F12G (1SNA295015R1200 + SCH8).

Ordering details

Description	Color	Type	Part Numbers	Pkg qty	Weight (1 pce)
1 stud M6 and 12 tabs 1 circuit	Beige <input type="checkbox"/>	HD6/30.F12G	1SNA295015R1200	10	42.00

Main technical data

Connecting capacity	NF C	DIN	NF F 61-017	Rail	Tool	Torque
Wire size	Lug (NF C 20-130) Lug (DIN 46235 / 46234) Quick-connect: 6.3 x 0.8 mm	1.5 ... 35 mm ²	2.5 ... 35 mm ²	0.34 ... 6 mm ²	Type 2, TH 35-7.5, TH 35-15	Wrench Ø 10 mm Ø 0.394 in
Rated voltage	V AC V DC	(Cat. C) 750 V (Cat. C) 750 V	(Cat. C) 750 V (Cat. C) 900 V	380 V 500 V		5.3 N.m 46.9 lb.in
Rated current				155/16 A		
Rated cross section		35 mm ²				

Mounting instructions

--	--	--	--	--	--	--	--	--	--

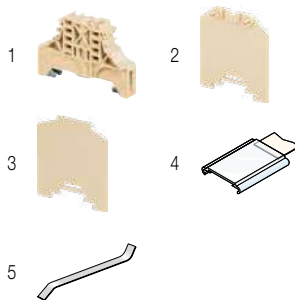

Accessories

Description	Color	Type	Part Numbers	Pkg qty	Weight (1 pce)
1 End stops	Beige <input type="checkbox"/>	BAM2	1SNA296351R0000	50	12.00
		BAH22	1SNA164655R0400	50	10.00
2 End sections	Beige <input type="checkbox"/>	FJH501	1SNA199411R1400	25	6.50
3 Circuit separators	Beige <input type="checkbox"/>	SCH8	1SNA199412R1500	25	4.80
4 Protecting covers	Transparent <input type="checkbox"/>	CPM	1SNA187312R1400	1	25.00
	Beige <input type="checkbox"/>	CPM	1SNA197312R1600	10	25.00
5 Terminal block markers	White <input type="checkbox"/>	RTC	1SNA163156R2700	1	10.00
		PEFH	1SNA163497R1600	10	
		RPED	1SNA163518R2200	1	12.00
	White <input type="checkbox"/>	RC610	1SNA233000R0100	10	7.50

HD6/14.SF Quick connect terminal blocks

For 5x20 fuse - 14 mm 0.551 in spacing



6 mm²

Description

- Terminal block for 5x20 fuse,
- Connection by 2 tabs for quick-connect 6.3 x 0.8 mm 0.248 x 0.031 in on each side.

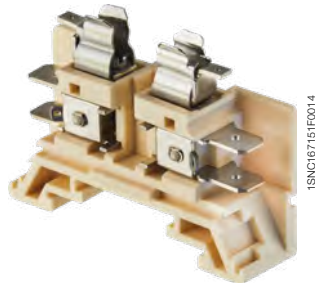

1SNMC16715FF0014

HD6/14.SF

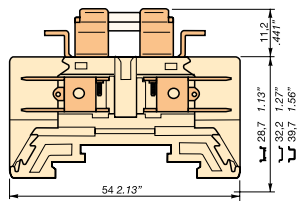

14 mm 0.551 in spacing

Ordering details

Description	Color	Type	Part Numbers	Pkg qty	Weight (1 pce) g
2 tabs on each side	Beige <input type="checkbox"/>	HD6/14.SF.2G.2G	1SNA162315R2500	10	17.00

Main technical data

Connecting capacity	NF C	DIN	NF F 61-017	Mounting instructions	
1 conductor per clamp	Quick-connect: 6.3 x 0.8 mm	0.34 ... 6 mm ²		Rail	Type 2, TH 35-7.5, TH 35-15
Rated voltage	V AC (Cat. C) 500 V	(Cat. C) 500 V	(Cat. C) 500 V		
	V DC (Cat. C) 500 V	(Cat. C) 500 V	(Cat. C) 600 V		
Rated current	25 A	25 A	26 A		
Rated cross section	6 mm ²	6 mm ²	6 mm ²		

--	--	--	--	--	--	--	--	--	--	--

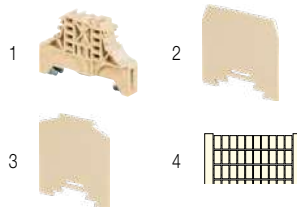

Accessories

Description	Color	Type	Part Numbers	Pkg qty	Weight (1 pce) g
1 End stops	Beige <input type="checkbox"/>	BAM2	1SNA296351R0000	50	12.00
		BAH24	1SNA168355R1300	50	12.00
2 End sections	Beige <input type="checkbox"/>	FEH9	1SNA198549R0500	10	4.30
3 Circuit separators	Beige <input type="checkbox"/>	SCH8	1SNA199412R1500	25	4.80
4 Terminal block markers	White <input type="checkbox"/>	RC610	1SNA233000R0100	10	7.50

1SNMC167073S0201

HD6/24.DH Quick connect terminal blocks

Component holder - 24 mm 0.945 in spacing



6 mm²



1SNC167029/0014

HD6/24.DH

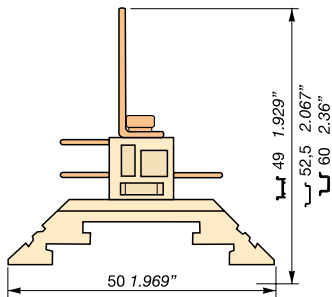

24 mm 0.945 in spacing

Description

- Terminal block for screw and solder diodes type SKN5 or SKNa4,
- Connection by 6 or 8 tabs for quick disconnects 6.3 x 0.8 mm 0.248 x 0.031 in,
- NF F 61-017 designation: BG25.2-2G2G (HD6/24.DH + SCH8).

Ordering details

Description	Color	Type	Part Numbers	Pkg qty	Weight (1 pce) g
6 tabs	Beige <input type="checkbox"/>	HD6/24.DH	1SNA399964R0600	10	20.00
8 tabs	Beige <input type="checkbox"/>	HD6/24.DH	1SNA399963R0500	10	20.00

Main technical data

Connecting capacity	NF C	DIN	NF F 61-017	Rail	Mounting instructions
1 conductor per clamp	Quick-connect: 6.3 x 0.8 mm	0.34 ... 6 mm ²			Type 2, TH 35-7.5, TH 35-15
Rated voltage	V AC	(Cat. C) 400 V	(Cat. C) 250 V	250 V	
	V DC	(Cat. C) 250 V	(Cat. C) 250 V	250 V	
Rated current		25 A	26 A	16 A	
Rated cross section		6 mm ²	6 mm ²		

CE	RoHS	EAC																	
----	------	-----	--	--	--	--	--	--	--	--	--	--	--	--	--	--	--	--	--

Accessories

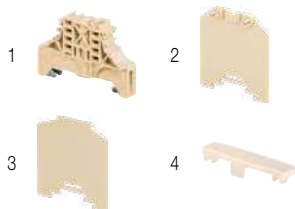

Description	Color	Type	Part Numbers	Pkg qty	Weight (1 pce) g
1 End stops	Beige <input type="checkbox"/>	10 mm 0.394 in	BAM2	50	12.00
		10.7 mm 0.421 in	BAH24	50	12.00
2 End sections	Beige <input type="checkbox"/>	FJH501	1SNA199411R1400	25	6.50
3 Circuit separators	Beige <input type="checkbox"/>	SCH8	1SNA199412R1500	25	4.80
4 Terminal block markers	White <input type="checkbox"/>	Label holder	PEFH	10	
		Blank label for PEFH	RPED	1	12.00
		Blank card	RC610	10	7.50

HD6/14.DH Quick connect terminal blocks

Component holder - 14 mm 0.551 in spacing



6 mm²

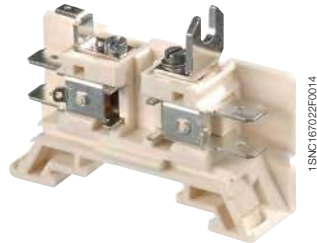

1SNC167022R0014

HD6/14.DH

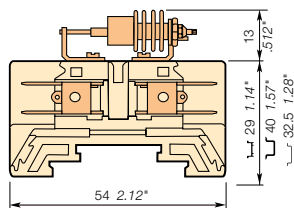

14 mm 0.551 in spacing

Description

- Terminal block for screw and solder diodes type SKN2.5 or SKNa2,
- Connection by 2 tabs for quick disconnects 6.3 x 0.8 mm 0.248 x 0.031 in on each side,
- NF F 61-017 designation: BG0014-2G2G (1SNA162971R2700).

Ordering details

Description	Color	Type	Part Numbers	Pkg qty	Weight (1 pce) g
2 tabs on each side	Beige <input type="checkbox"/>	HD6/14.DH	1SNA162971R2700	10	20.00

Main technical data

Connecting capacity	NF C	DIN	NF F 61-017	Mounting instructions	
1 conductor per clamp	Quick-connect: 6.3 x 0.8 mm	0.34 ... 6 mm ²		Rail	Type 2, TH 35-7.5, TH 35-15
Rated voltage	V AC	(Cat. C) 500 V	(Cat. C) 500 V		
	V DC	(Cat. C) 500 V	(Cat. C) 600 V	380 V	
Rated current		25 A	26 A	12 A	
		6 mm ²	6 mm ²		
Rated cross section					

CE	RoHS	EAC																	
----	------	-----	--	--	--	--	--	--	--	--	--	--	--	--	--	--	--	--	--

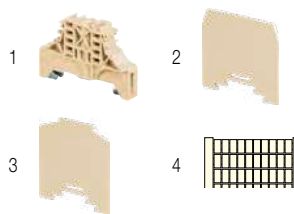

Accessories

Description	Color	Type	Part Numbers	Pkg qty	Weight (1 pce) g
1 End stops					
	10 mm 0.394 in	Beige <input type="checkbox"/>	BAM2	1SNA296351R0000	50 12.00
	10.7 mm 0.421 in	Beige <input type="checkbox"/>	BAH24	1SNA168355R1300	50 12.00
2 End sections	1.6 mm 0.063 in	Beige <input type="checkbox"/>	FEH9	1SNA198549R0500	10 4.30
3 Circuit separators	1.2 mm 0.047 in	Beige <input type="checkbox"/>	SCH8	1SNA199412R1500	25 4.80
4 Terminal block markers	Blank card	White <input type="checkbox"/>	RC610	1SNA233000R0100	10 7.50

HD6/14.DG Quick connect terminal blocks

Component holder - 14 mm 0.551 in spacing

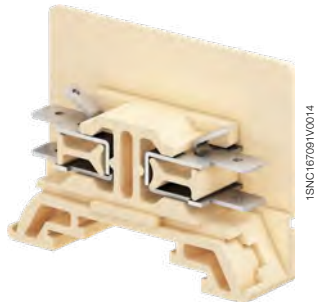

HD6/14.DG

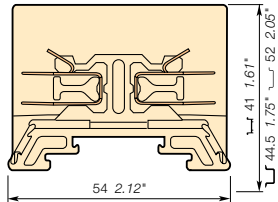

14 mm 0.551 in spacing

Description

- Terminal block for solder diodes or resistors,
- Connection by 2 tabs for quick-connect 6.3 x 0.8 mm 0.248 x 0.031 in on each side,
- NF F 61-017 designation: BG0014-2G2G (1SNA162309R1000).

Ordering details

Description	Color	Type	Part Numbers	Pkg qty	Weight (1 pce) g
2 tabs on each side	Beige <input type="checkbox"/>	HD6/14.DG	1SNA162309R1000	10	20.00

Main technical data

Connecting capacity	NF C	DIN	NF F 61-017	Rail	Type 2, TH 35-7.5, TH 35-15
1 conductor per clamp	Quick-connect: 6.3 x 0.8 mm	0.34 ... 6 mm ²			
Rated voltage	V AC	(Cat. C) 500 V	(Cat. C) 500 V	380 V	
	V DC	(Cat. C) 500 V	(Cat. C) 600 V	500 V	
Rated current		25 A	26 A	12 A	
Rated cross section		6 mm ²	6 mm ²		

Mounting instructions

CE	RoHS	EAC							
----	------	-----	--	--	--	--	--	--	--

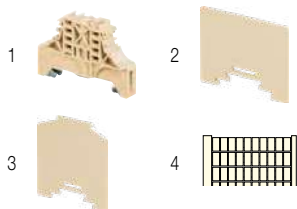

Accessories

Description	Color	Type	Part Numbers	Pkg qty	Weight (1 pce) g
1 End stops	Beige <input type="checkbox"/>	BAM2	1SNA296351R0000	50	12.00
		BAH24	1SNA168355R1300	50	12.00
2 End sections	Beige <input type="checkbox"/>	FEH8	1SNA198729R0100	25	4.30
3 Circuit separators	Beige <input type="checkbox"/>	SCH8	1SNA199412R1500	25	4.80
4 Terminal block markers	White <input type="checkbox"/>	RC610	1SNA233000R0100	10	7.50

HD6/9.SDH.1 Quick connect terminal blocks

Component holder - 9.2 mm 0.362 in spacing



6 mm²

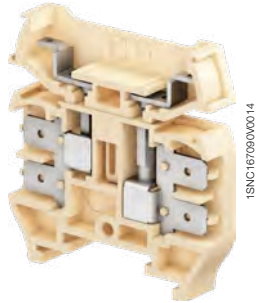

HD6/9.SDH.1

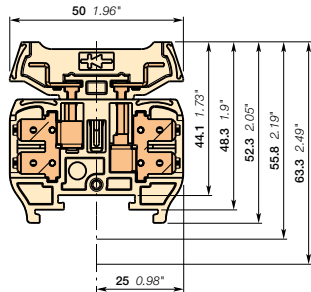

9.2 mm 0.362 in spacing

Description

- Connection interruptible by plugs for solder components DIA 7 mm 0.287 in max,
- Connection by 2 tabs for quick disconnects 6.3 x 0.8 mm 0.248 x 0.031 in on each side,
- NF F 61-017 designation: BH09.2-2G2G (1SNA162309R1000).

Ordering details

Description	Color	Type	Part Numbers	Pkg qty	Weight (1 pce) g
4 tabs	Beige <input type="checkbox"/>	HD6/9.SDH.1	1SNA400800R0000	25	

Main technical data

Connecting capacity	NF C	DIN	NF F 61-017	Rail	Mounting instructions
1 conductor per clamp	Quick-connect: 6.3 x 0.8 mm	0.34 ... 6 mm ²			Type 2, TH 35-7.5, TH 35-15
Rated voltage	V AC		380 V		
	V DC		500 V		
Rated current			16 A		
Rated cross section		6 mm ²			

Mounting instructions

--	--	--	--	--	--	--	--	--	--	--	--	--	--	--	--	--	--	--	--



Accessories

Description	Color	Type	Part Numbers	Pkg qty	Weight (1 pce) g
1 End stops	Beige <input type="checkbox"/>	BAM2	1SNA296351R0000	50	12.00
		BAH24	1SNA168355R1300	50	12.00
2 End sections	Beige <input type="checkbox"/>	FESDH	1SNA400799R0000	10	
3 Circuit separators	Beige <input type="checkbox"/>	SCH8	1SNA199412R1500	25	4.80
4 Terminal block markers	White <input type="checkbox"/>	RC810	1SNA234000R0200	10	8.20

1SNC167051S0201

HD6/14.SDH.1 Quick connect terminal blocks

Component holder - 14 mm 0.551 in spacing



6 mm²

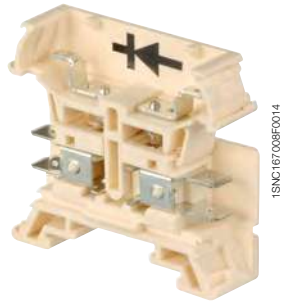

1SNC1670685014

HD6/14.SDH.1

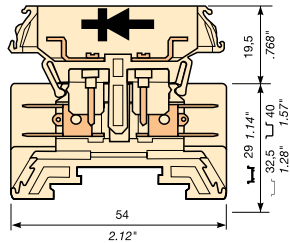

14 mm 0.551 in spacing

Description

- Connection interruptible by plugs for solder components,
- Connection by 2 tabs for quick disconnects 6.3 x 0.8 mm 0.248 x 0.031 in on each side,
- NF F 61-017 designation: BH0014-2G2G (1SNA162988R2100).

Ordering details

Description	Color	Type	Part Numbers	Pkg qty	Weight (1 pce) g
2 tabs on each side	Beige <input type="checkbox"/>	HD6/14.SDH.1	1SNA162988R2100	10	30.00

Main technical data

Connecting capacity	NF C	DIN	NF F 61-017	Mounting instructions
1 conductor per clamp	Quick-connect: 6.3 x 0.8 mm	0.34 ... 6 mm ²		Rail Type 2, TH 35-7.5, TH 35-15
Rated voltage	V AC	(Cat. C) 500 V	(Cat. C) 500 V	380 V
	V DC	(Cat. C) 500 V	(Cat. C) 600 V	500 V
Rated current		25 A	26 A	16 A
Rated cross section		6 mm ²	6 mm ²	

--	--	--	--	--	--	--	--	--	--	--

5

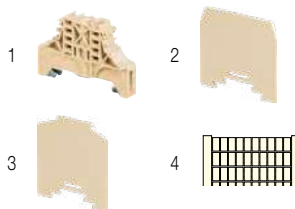

Accessories

Description	Color	Type	Part Numbers	Pkg qty	Weight (1 pce) g
1 End stops	Beige <input type="checkbox"/>	BAM2	1SNA296351R0000	50	12.00
		BAH24	1SNA168355R1300	50	12.00
2 End sections	Beige <input type="checkbox"/>	FEH9	1SNA198549R0500	10	4.30
3 Circuit separators	Beige <input type="checkbox"/>	SCH8	1SNA199412R1500	25	4.80
4 Terminal block markers	White <input type="checkbox"/>	RC610	1SNA233000R0100	10	7.50

1SNC16706850201

HD6/14.SDH Quick connect terminal blocks

Component holder - 14 mm 0.551 in spacing



6 mm²

Description

- Terminal block for screw and solder diodes type SKN2.5 or SKNa2,
- Connection by 2 tabs for quick disconnects 6.3 x 0.8 mm 0.248 x 0.031 in on each side,
- NF F 61-017 designation: BH0014-2G2G (1SNA162972R2000).

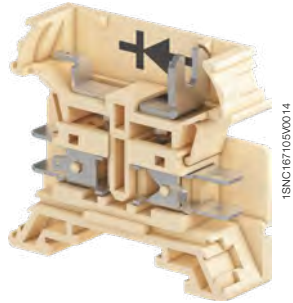

HD6/14.SDH

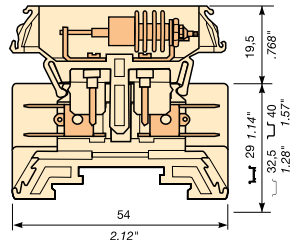

14 mm 0.551 in spacing

Ordering details

Description	Color	Type	Part Numbers	Pkg qty	Weight (1 pce) g
2 tabs on each side	Beige <input type="checkbox"/>	HD6/14.SDH	1SNA162972R2000	10	30.00

Main technical data

Connecting capacity	NF C	DIN	NF F 61-017	Mounting instructions	
1 conductor per clamp	Quick-connect: 6.3 x 0.8 mm	0.34 ... 6 mm ²		Rail	Type 2, TH 35-7.5, TH 35-15
Rated voltage	V AC	(Cat. C) 500 V	(Cat. C) 500 V		
	V DC	(Cat. C) 500 V	(Cat. C) 600 V		
Rated current		25 A	26 A		
			16 A		
Rated cross section		6 mm ²	6 mm ²		

CE	RoHS	EAC																		
----	------	-----	--	--	--	--	--	--	--	--	--	--	--	--	--	--	--	--	--	--

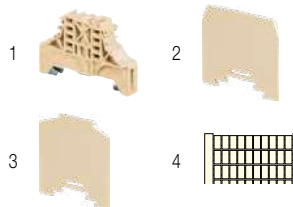

Accessories

Description	Color	Type	Part Numbers	Pkg qty	Weight (1 pce) g
1 End stops					
	10 mm 0.394 in	Beige <input type="checkbox"/>	BAM2	50	12.00
	10.7 mm 0.421 in	Beige <input type="checkbox"/>	BAH24	50	12.00
2 End sections					
	1.6 mm 0.063 in	Beige <input type="checkbox"/>	FEH9	10	4.30
3 Circuit separators					
	1.2 mm 0.047 in	Beige <input type="checkbox"/>	SCH8	25	4.80
4 Terminal block markers					
	Blank card	White <input type="checkbox"/>	RC610	10	7.50

5

1SNC167069S0201

HD2.5/6.3.3G.3G.1 Quick connect terminal blocks

Feed-through - 6 mm 0.236 in spacing



Description

- Connection by 6 longitudinal tabs for quick-connect 6.3 x 0.8 mm 0.248 x 0.031 in,
- Possibility of testing and transverse connection,
- Use of jumper bars requires to cut out the precut partition.

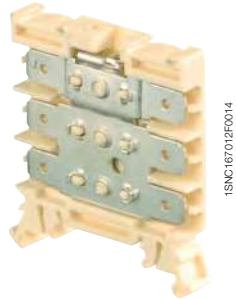

HD2.5/6.3.3G.3G.1

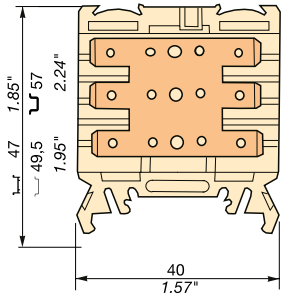

6 mm 0.236 in spacing

Ordering details

Description	Color	Type	Part Numbers	Pkg qty	Weight (1 pce) g
6 tabs 1 circuit	Beige <input type="checkbox"/>	HD2.5/6.3.3G.3G.1	1SNA190316R2700	50	11.00

Main technical data

Connecting capacity	NF C	DIN	NF F 61-017	Rail	Mounting instructions
1 conductor per clamp Quick-connect: 6.3 x 0.8 mm	0.34 ... 2.5 mm ²				Type 2, TH 35-7.5, TH 35-15
Rated voltage	V AC (Cat. C) 250 V	(Cat. C) 250 V			
	V DC (Cat. C) 250 V	(Cat. C) 300 V			
Rated current	25 A				
Rated cross section	2.5 mm ²				

--	--	--	--	--	--	--	--	--	--

Accessories

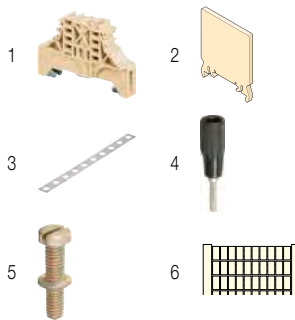

Description	Color	Type	Part Numbers	Pkg qty	Weight (1 pce) g
1 End stops 10 mm 0.394 in	Beige <input type="checkbox"/>	BAM2	1SNA296351R0000	50	12.00
10.7 mm 0.421 in		BAH24	1SNA168355R1300	50	12.00
2 End sections 1 mm 0.039 in	Beige <input type="checkbox"/>	FEHD2	1SNA168949R1700	20	2.00
3 Jumper bars 2 poles 32 A (IEC)		BJS61-2	1SNA168481R2300	10	1.80
3 poles 32 A (IEC)		BJS61-3	1SNA168482R2400	10	1.80
4 poles 32 A (IEC)		BJS61-4	1SNA168483R2500	10	1.80
5 poles 32 A (IEC)		BJS61-5	1SNA168484R2600	10	1.80
10 poles 32 A (IEC)		BJS61-10	1SNA168485R2700	10	2.00
4 Test plugs DIA 2 mm 0.079 in	Black <input type="checkbox"/>	FC2	1SNA007865R2600	100	2.00
5 Fastening kits Screw M2.5x5 for jumper bar BJH		VSJ6	1SNA167735R2700	1	
Washer for screw VSJ		RDJ6	1SNA173241R0600	1000	0.10
6 Terminal block markers Blank card	White <input type="checkbox"/>	RC610	1SNA233000R0100	10	7.50

HD2.5/6.3.GG1.2G.2G Quick connect terminal blocks

Feed-through - 6 mm 0.236 in spacing

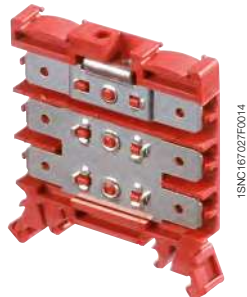

HD2.5/6.3.GG1.2G.2G

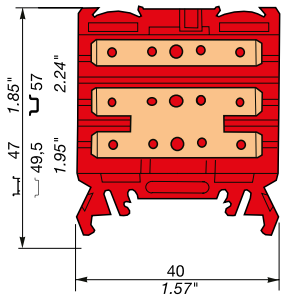

6 mm 0.236 in spacing

Description

- 2 circuits: 1 circuit with 2 longitudinal tabs for quick-connect 6.3 x 0.8 mm 0.248 x 0.031 in, possibility of testing and transverse connection and 1 circuit with 4 longitudinal tabs for quick-connect 6.3 x 0.8 mm 0.248 x 0.031 in,
- Use of jumper bars requires to cut out the precut partition.

Ordering details

Description	Color	Type	Part Numbers	Pkg qty	Weight (1 pce) g
6 tabs 2 circuits	Red ■	HD2.5/6.3.GG1.2G.2G	1SNA190314R2500	50	11.00

Main technical data

Connecting capacity	NF C	DIN	NF F 61-017	Mounting instructions
1 conductor per clamp Quick-connect: 6.3 x 0.8 mm	0.34 ... 2.5 mm²			
Rated voltage	V AC (Cat. C) 250 V V DC (Cat. C) 250 V	(Cat. C) 250 V (Cat. C) 300 V		
Rated current	25 A			
Rated cross section	2.5 mm²	2.5 mm²		

CE	RoHS	RoHS	ErC	EAC
----	------	------	-----	-----

Accessories

Description	Color	Type	Part Numbers	Pkg qty	Weight (1 pce) g
1 End stops	Beige □	BAM2	1SNA296351R0000	50	12.00
2 End sections	Beige □	BAH24	1SNA168355R1300	50	12.00
3 Jumper bars		BJS61-2	1SNA168481R2300	10	1.80
		BJS61-3	1SNA168482R2400	10	1.80
		BJS61-4	1SNA168483R2500	10	1.80
		BJS61-5	1SNA168484R2600	10	1.80
		BJS61-10	1SNA168485R2700	10	2.00
4 Test plugs	Black ■	FC2	1SNA007865R2600	100	2.00
5 Fastening kits		VSJ6	1SNA167735R2700	1	
		RDJ6	1SNA173241R0600	1000	0.10
6 Terminal block markers	White □	RC610	1SNA233000R0100	10	7.50

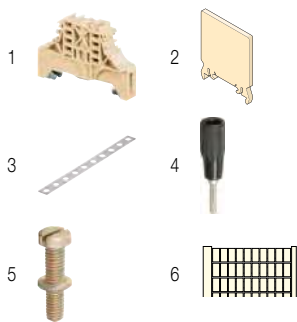

HD2.5/6.3.GG.1.2GG Quick connect terminal blocks

Feed-through - 6 mm 0.236 in spacing



2.5 mm²

Description

- 3 circuits: 1 circuit with 2 longitudinal tabs for quick-connect 6.3 x 0.8 mm 0.248 x 0.031 in, possibility of testing and transverse connection and 2 circuit with 2 longitudinal tabs for quick-connect 6.3 x 0.8 mm 0.248 x 0.031 in,
- Use of jumper bars requires to cut out the precut partition.

Ordering details

Description	Color	Type	Part Numbers	Pkg qty	Weight (1 pce) g
6 tabs 3 circuits	Green	HD2.5/6.3.GG.1.2GG	1SNA199025R1400	50	11.00

Main technical data

Connecting capacity	NF C	DIN	NF F 61-017	Mounting instructions
1 conductor per clamp Quick-connect: 6.3 x 0.8 mm	0.34 ... 2.5 mm ²			Rail Type 2, TH 35-7.5, TH 35-15
Rated voltage V AC	(Cat. C) 250 V	(Cat. C) 250 V		
V DC	(Cat. C) 250 V	(Cat. C) 300 V		
Rated current	25 A			
Rated cross section	2.5 mm ²			



1SNC167144F0014

HD2.5/6.3.GG.1.2GG

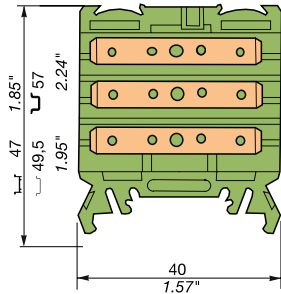

6 mm 0.236 in spacing

CE	RoHS	EAC																	
----	------	-----	--	--	--	--	--	--	--	--	--	--	--	--	--	--	--	--	--

Accessories

Description	Color	Type	Part Numbers	Pkg qty	Weight (1 pce) g
1 End stops 10 mm 0.394 in 10.7 mm 0.421 in	Beige	BAM2	1SNA296351R0000	50	12.00
2 End sections 1 mm 0.039 in	Beige	FEHD2	1SNA168949R1700	20	2.00
3 Jumper bars 2 poles 32 A (IEC) 3 poles 32 A (IEC) 4 poles 32 A (IEC) 5 poles 32 A (IEC) 10 poles 32 A (IEC)		BJS61-2 BJS61-3 BJS61-4 BJS61-5 BJS61-10	1SNA168481R2300 1SNA168482R2400 1SNA168483R2500 1SNA168484R2600 1SNA168485R2700	10 10 10 10 10	1.80 1.80 1.80 1.80 2.00
4 Test plugs DIA 2 mm 0.079 in	Black	FC2	1SNA007865R2600	100	2.00
5 Fastening kits Screw M2.5X5 for jumper bar BJH Washer for screw VSJ		VSJ6 RDJ6	1SNA167735R2700 1SNA173241R0600	1 1000	1 0.10
6 Terminal block markers Blank card	White	RC610	1SNA233000R0100	10	7.50

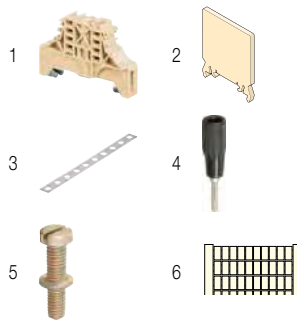

HD2.5/6.3.2G.2G.1 Quick connect terminal blocks

Feed-through - 6 mm 0.236 in spacing



Description

- Connection by 4 longitudinal tabs for quick-connect 6.3 x 0.8 mm 0.248 x 0.031 in,
- Possibility of testing and transverse connection,
- Use of jumper bars requires to cut out the precut partition.

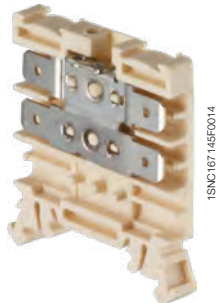

HD2.5/6.3.2G.2G.1

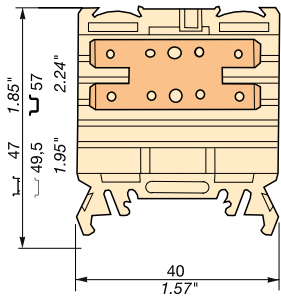

6 mm 0.236 in spacing

Ordering details

Description	Color	Type	Part Numbers	Pkg qty	Weight (1 pce) g
4 tabs 1 circuit	Beige <input type="checkbox"/>	HD2.5/6.3.2G.2G.1	1SNA190305R0500	50	10.00

Main technical data

Connecting capacity	NF C	DIN	NF F 61-017	Rail	Mounting instructions
1 conductor per clamp Quick-connect: 6.3 x 0.8 mm	0.34 ... 2.5 mm ²				Type 2, TH 35-7.5, TH 35-15
Rated voltage	V AC (Cat. C) 250 V	(Cat. C) 250 V			
	V DC (Cat. C) 250 V	(Cat. C) 300 V			
Rated current	25 A				
Rated cross section	2.5 mm ²				

--	--	--	--	--	--	--	--	--	--

Accessories

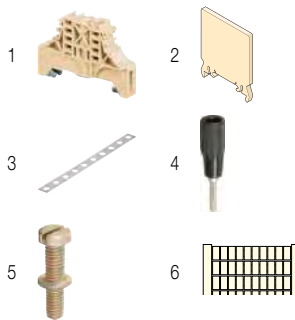

Description	Color	Type	Part Numbers	Pkg qty	Weight (1 pce) g
1 End stops 10 mm 0.394 in	Beige <input type="checkbox"/>	BAM2	1SNA296351R0000	50	12.00
10.7 mm 0.421 in		BAH24	1SNA168355R1300	50	12.00
2 End sections 1 mm 0.039 in	Beige <input type="checkbox"/>	FEHD2	1SNA168949R1700	20	2.00
3 Jumper bars 2 poles 32 A (IEC)		BJS61-2	1SNA168481R2300	10	1.80
3 poles 32 A (IEC)		BJS61-3	1SNA168482R2400	10	1.80
4 poles 32 A (IEC)		BJS61-4	1SNA168483R2500	10	1.80
5 poles 32 A (IEC)		BJS61-5	1SNA168484R2600	10	1.80
10 poles 32 A (IEC)		BJS61-10	1SNA168485R2700	10	2.00
4 Test plugs DIA 2 mm 0.079 in	Black <input type="checkbox"/>	FC2	1SNA007865R2600	100	2.00
5 Fastening kits Screw M2.5x5 for jumper bar BJH		VSJ6	1SNA167735R2700	1	
Washer for screw VSJ		RDJ6	1SNA173241R0600	1000	0.10
6 Terminal block markers Blank card	White <input type="checkbox"/>	RC610	1SNA233000R0100	10	7.50

HD2.5/6.3.GH.2G.H Quick connect terminal blocks

Feed-through - 6 mm 0.236 in spacing



HD2.5/6.3.GH.2G.H

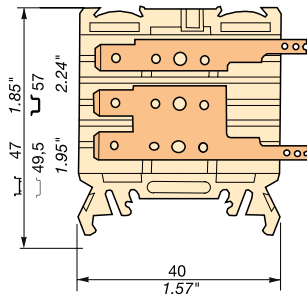

6 mm 0.236 in spacing

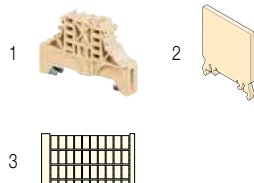

Description

– 2 circuits: 1 circuit with 1 longitudinal tabs for quick-connect 6.3 x 0.8 mm 0.248 x 0.031 in and 1 pin for soldered connection, and 1 circuit with 2 longitudinal tabs for quick-connect 6.3 x 0.8 mm 0.248 x 0.031 in and 1 pin for soldered connection.

Ordering details

Description	Color	Type	Part Numbers	Pkg qty	Weight (1 pce) g
3 tabs and 2 pins	Beige <input type="checkbox"/>	HD2.5/6.3.GH.2G.H	1SNA199096R1400	50	11.00

Main technical data

Connecting capacity	NF C	DIN	NF F 61-017	Mounting instructions
1 conductor per clamp	Quick-connect: 0.34 ... 2.5 mm ² 6.3 x 0.8 mm			Rail Type 2, TH 35-7.5, TH 35-15
Rated voltage	V AC (Cat. C) 250 V V DC (Cat. C) 250 V	(Cat. C) 250 V (Cat. C) 300 V		
Rated current	25 A			
Rated cross section	2.5 mm ²			

--	--	--	--	--	--	--	--	--	--

Accessories

Description	Color	Type	Part Numbers	Pkg qty	Weight (1 pce) g
1 End stops	Beige <input type="checkbox"/>	BAM2	1SNA296351R0000	50	12.00
		BAH24	1SNA168355R1300	50	12.00
2 End sections	Beige <input type="checkbox"/>	FEHD2	1SNA168949R1700	20	2.00
3 Terminal block markers	White <input type="checkbox"/>	RC610	1SNA233000R0100	10	7.50

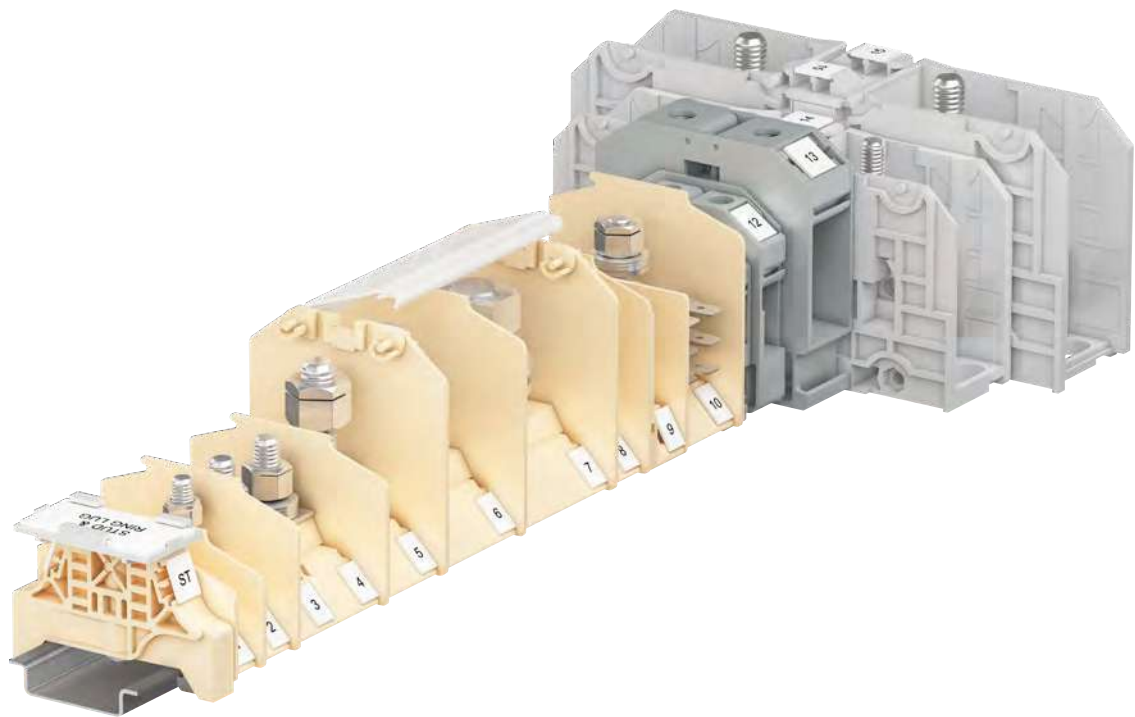

Railway applications, terminal blocks

Stud technology



Technologies presentation	170
Overview	172

1 stud

4 mm ²	HD4/9.F4	M4 stud with self locking nut + spring washers	176
	HD4/9.F4.2	M4 stud with nut	177
	HD4/10.F4.19	M4 stud with self locking nut + TREP washers	178
10 mm ²	HD10/12.F5.3	M5 stud with self locking nut + spring washers	179
	HD10/12.F5	M5 stud with self locking nut + TREP washers	180
	HD10/12.F5.1	M5 stud with 2 nuts + spring washers	181
	HD10/12.F5.2	M5 stud with 2 brass nuts + spring washers	181
35 mm ²	HD35/16.F6.19	M6 stud with self locking nut + TREP washers	182
	HD35/16.F6.19.1	M6 stud with 2 nuts + spring washers	183
70 mm ²	HD70/22.F8.31	M8 stud with self locking nut + TREP washers	184
	HD70/22.F8.31.1	M8 stud with 2 nuts + spring washers	185
	HD70/22.F8.31.2	M8 stud with 2 brass nuts + spring washers	185
120 mm ²	HD120/30.F10.31	M10 stud with self locking nut + TREP washers	186
	HD120/30.F10.31.1	M10 stud with 2 nuts + spring washers	187
185 mm ²	HD185/36.F12.31.1	M12 stud with 2 nuts + spring washers	188

2 studs for TH35 & type 2 rails mounting

4 mm ²	HD4/9.FF4	M4 studs with self locking nut + spring washers	189
6 mm ²	HD6/13.FF4	M4 studs with self locking nut + spring washers	190
10 mm ²	HD10/12.FF5	M5 studs with self locking nut + TREP washers	191
16 mm ²	HD16/14.FF5.21.3	M5 studs with self locking nut + spring washers	192
	HD16/14.FF5.20.3	M5 studs with self locking nut + spring washers	193
	HD16/14.FF5.21	M5 studs with self locking nut + TREP washers	194
	HD16/14.FF5.20	M5 studs with self locking nut + TREP washers	195

2 studs for TH35 & base mounting

35 mm ² / 1 AWG	D35/27.FF	M6 studs with 2 nuts + spring washers	196
70 mm ² / 000 AWG	D70/32.FF	M8 studs with 2 nuts + spring washers	197
120 mm ² / 300 Kcmil	D120/42.FF	M10 studs with 2 nuts + spring washers	198
185 mm ² / 500 Kcmil	D185/55.FF	M12 studs with 2 nuts + spring washers	199
300 mm ² / 1000 Kcmil	D300/55.FF	M16 studs with 2 nuts + spring washers	200

2 studs with captive nuts

2.5 mm ² / 14 AWG	RGW2.5-V0	M3 studs feed-through with captive nuts	201
6 mm ² / 10 AWG	RGW6-V0	M4 studs feed-through with captive nuts	202
25 mm ² / 4 AWG	RGW25-M5-V0	M5 studs feed-through with captive nuts	203
25 mm ² / 4 AWG	RGW25-M6-V0	M6 studs feed-through with captive nuts	204

Railway applications, terminal blocks

Stud technology



The “Pull-out proof” connection for rolling stock

The stud technology allows all power distribution configurations and improves wiring secureness thanks to “Pull-out proof” connection (stud+lug).

The HD terminal blocks provides a large scope of 1 and 2 studs configurations with different types of washers and nuts (Onduflex®, Trep®, Grover®).

The D type power blocks provide an alternative with specific locking foot and rotative covers.

The RGW terminal blocks offer a combination of fast and secured wiring, with captive nuts in a pivoting wing.



Reliable in harsh conditions

Continuous operation guaranteed for rolling stock

- Environmental tests: aging, corrosion, flammability, toxicity (I2F2, V0, HL3 R22)
- Mechanical tests: vibration and shock.



Safety and protection

Secured wiring

- Captive wire connection: stud + ring lug
- Anti-vibration and anti-loosening equipments: self locking nuts, spring washers.

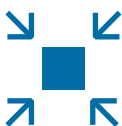

More control in smaller space

High density wiring with compact design

- 2 studs version: up to 4 conductors per block
- Compact 1 stud version for 2 conductors.

Features

HD / D type

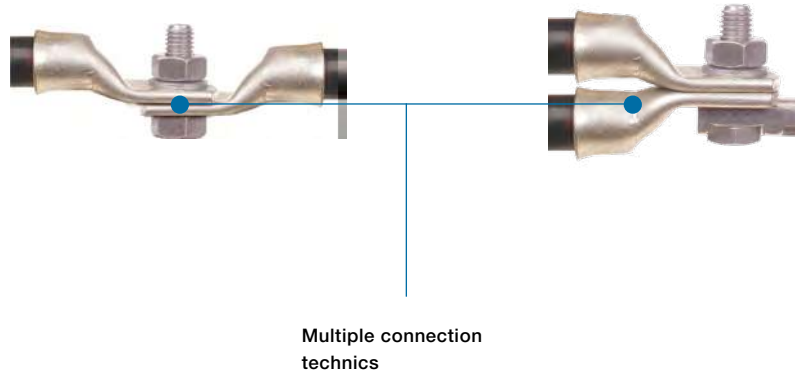

RGW type

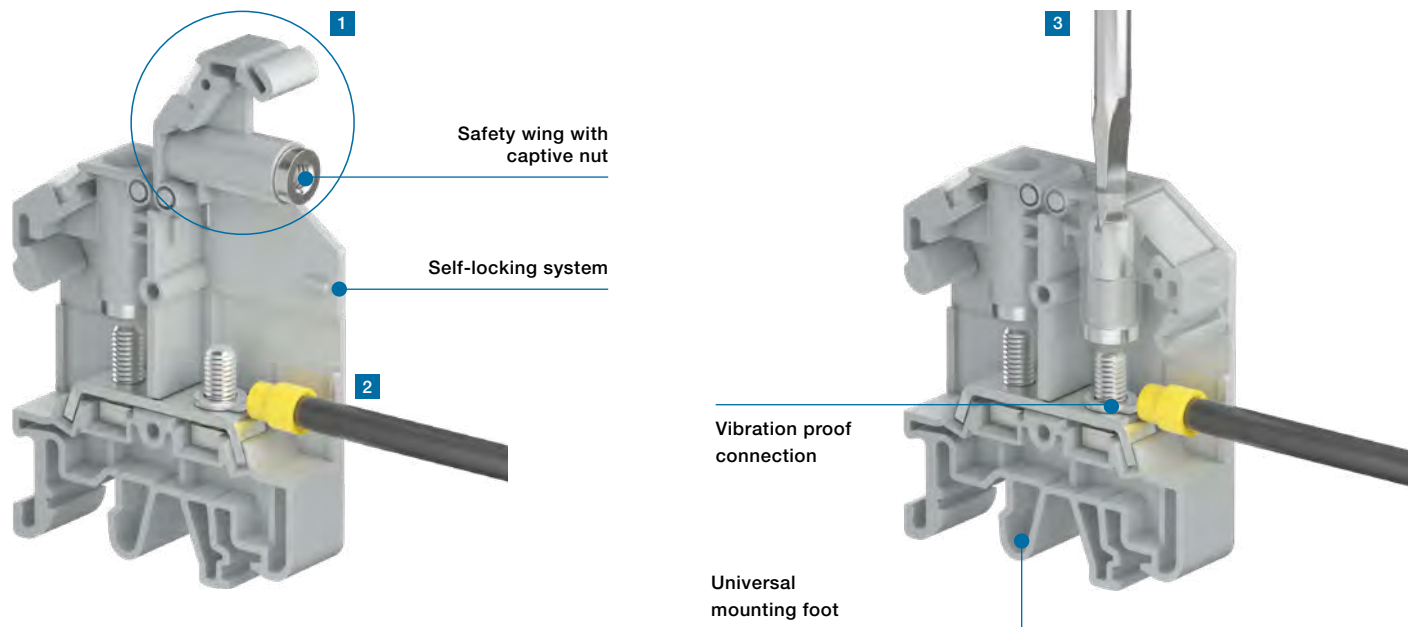

Easy 3 step wiring :

- 1 Open the safety wing -
- 2 Hook the wire on the stud and close the wing -
- 3 Screw down the nut

Railway applications, terminal blocks

Stud technology

Range overview up to 300 mm² / 1 000 Kcmil

HD type

From 4 mm² (M4)
to 185 mm² (M12)

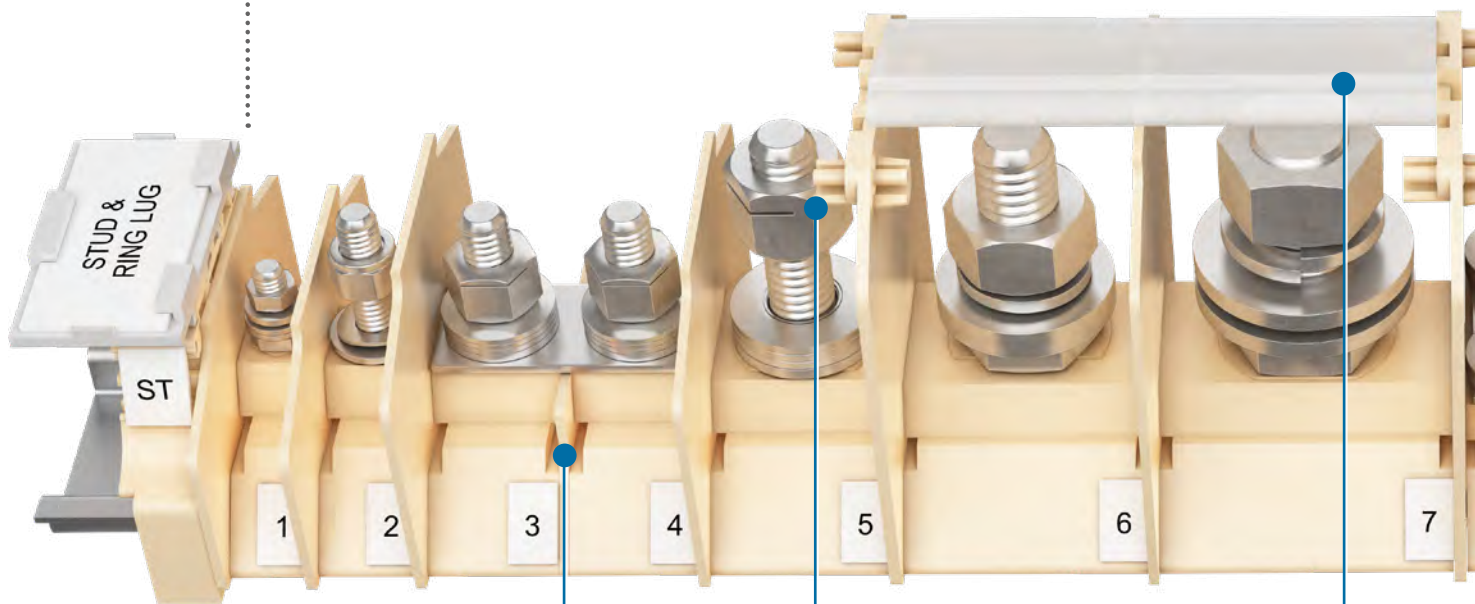

Spacers

Provide sufficient space between neighboring terminal blocks

Anti-loosening equipments

Self-locking nut, plastic elastic washer or conical spring washers maintaining a constant pressure on the contact

Rotative cover

Protects the metallic parts

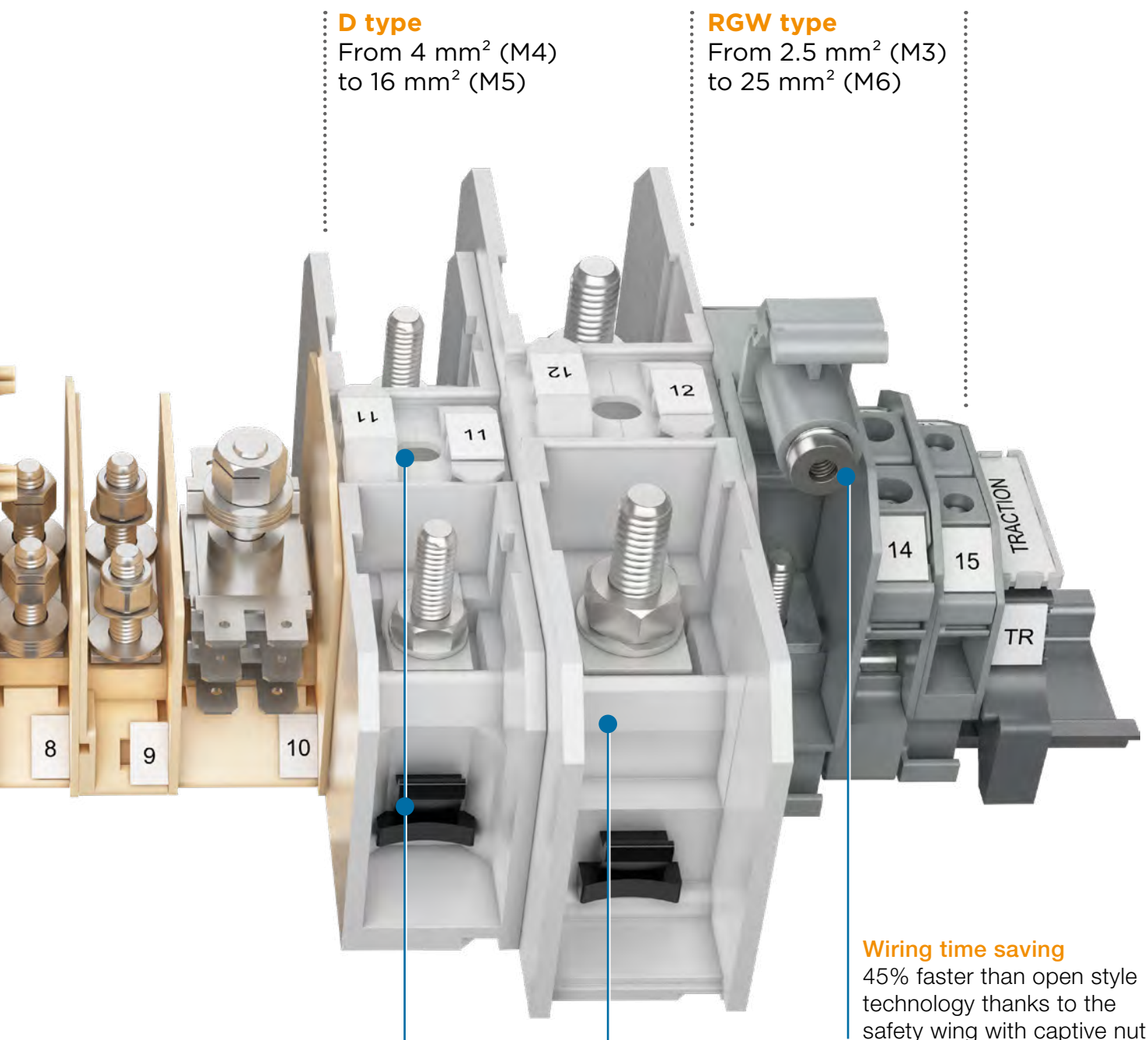

D type

From 4 mm² (M4)
to 16 mm² (M5)

RGW type

From 2.5 mm² (M3)
to 25 mm² (M6)

Wiring time saving

45% faster than open style technology thanks to the safety wing with captive nut

Easy locking / unlocking on the rail

Locking: single push on side foot
Unlocking: quarter-turn on the center

Adaptable protective cover

Removable and rotating for easier wiring





HD type - 1 Stud for TH35 & type 2 rails mounting

Section							
4 mm ²	M4	HD4/9.F4 HD4/9.F4.2 HD4/10.F4.19					
10 mm ²	M5		HD10/12.F5 HD10/12.F5.1...5.2 HD10/12.F5.3				
35 mm ²	M6			HD35/16.F6.19 HD35/16.F6.19.1			
70 mm ²	M8				HD70/22.F8.31 HD70/22.F8.31.1 HD70/22.F8.31.2		
120 mm ²						HD120/30.F10.31 HD120/30.F10.31.1	
185 mm ²							HD185/36.F12.31.1



HD type - 2 Studs for TH35 & type 2 rails mounting

Section							
4 mm ²	M4	HD4/9.FF4					
6 mm ²	M4		HD6/13.FF4				
10 mm ²	M5			HD10/12.FF5			
16 mm ²	M5				HD16/14.FF5.21	HD16/14.FF5.21.3	HD16/14.FF5.20.3 HD16/14.FF5.20

Clamp -
 Channels for jumpering or testing -
 Test socket -
 Blown-fuse indicator



D type - 2 Studs for TH35

Section						
35 mm ²	M6	D35/27.FF				
70 mm ²	M8		D70/32.FF			
120 mm ²	M10			D120/42.FF		
185 mm ²	M12				D185/55.FF	
300 mm ²	M16					D300/55.FF

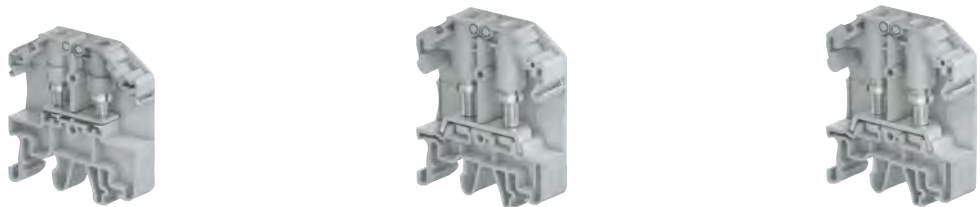
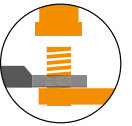

RGW type - 2 Studs with captive nuts for TH35

Section				
2.5 mm ²	M3	RGW2.5-V0		
6 mm ²	M4		RGW6-V0	
25 mm ²	M5			RGW25-M5-V0
	M6			RGW25-M6-V0

HD4/9.F4 stud terminal blocks

Feed-through - 9.5 mm 0.374 in spacing



Description

- 1 stud terminal M4 x 11.5 mm 0.453 in,
- Equipment: self locking nut + spring washer + washer.

Ordering details

Description	Color	Type	Part Numbers	Pkg qty	Weight (1 pce)
1 stud M4	Beige <input type="checkbox"/>	HD4/9.F4	1SNA295391R2000	100	6.00

Main technical data

Connecting capacity	NF C	DIN	NF F 61-017
Wire size	Lug (NF C 20-130) Lug (DIN 46235 / 46234) Quick-connect: 6.3 x 0.8 mm	0.5 ... 4 mm²	0.5 ... 4 mm²
Rated voltage	V AC V DC	(Cat. C) 500 V (Cat. C) 500 V	
Rated current		32 A	
Rated cross section		4 mm²	

Mounting instructions

Rail	Tool	Torque
Type 2, TH 35-7.5, TH 35-15	Wrench Ø 7 mm Ø 0.276 in	1.2 N.m 10.6 lb.in



1SNC167103V0014

HD4/9.F4

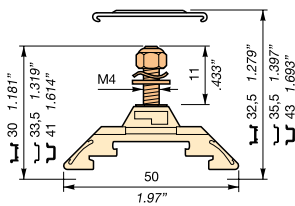

9.5 mm 0.374 in spacing

--	--	--	--	--	--	--	--	--	--

The use of a jumper bar requires to use a spacer instead of a circuit separator.

6

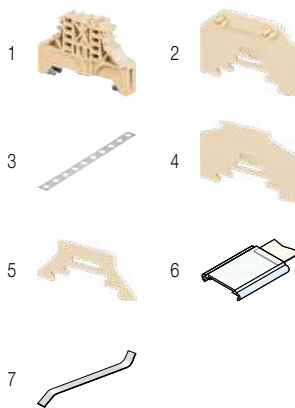

Accessories

Description	Color	Type	Part Numbers	Pkg qty	Weight (1 pce)
1 End stops	Beige <input type="checkbox"/>	BAM2	1SNA296351R0000	50	12.00
		BAH21	1SNA167489R2200	50	8.00
2 End sections	Beige <input type="checkbox"/>	FJHD32	1SNA295431R1000	25	4.00
3 Jumper bars		BJH105	1SNA163503R2400	10	197.00
4 Circuit separators	Beige <input type="checkbox"/>	SCHD1	1SNA295428R2500	25	2.00
5 Spacers	Beige <input type="checkbox"/>	INH1	1SNA295427R1400	25	2.00
6 Protecting covers	Transparent <input checked="" type="checkbox"/>	CPM	1SNA187312R1400	1	25.00
	Beige <input type="checkbox"/>	CPM	1SNA197312R1600	10	25.00
7 Terminal block markers	White <input type="checkbox"/>	RTC	1SNA163156R2700	1	10.00
		PEFH	1SNA163497R1600	10	
		RPED	1SNA163518R2200	1	12.00
	White <input type="checkbox"/>	RC610	1SNA233000R0100	10	7.50

HD4/9.F4.2 stud terminal blocks

Feed-through - 9.5 mm 0.374 in spacing



HD4/9.F4.2

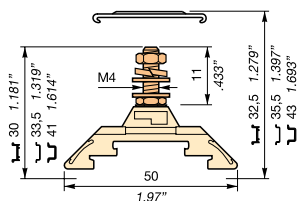

9.5 mm 0.374 in spacing

Description

- 1 stud terminal M4 x 11.5 mm 0.453 in,
- Equipment: 1 bottom nut + 2 washers + 1 spring washer + 1 top nut.

Ordering details

Description	Color	Type	Part Numbers	Pkg qty	Weight (1 pce) g
1 stud M4	Yellow <input type="checkbox"/>	HD4/9.F4.2	1SNA205392R0700	100	6.00
	Beige <input type="checkbox"/>	HD4/9.F4.2	1SNA295392R2100	100	6.00

Main technical data

Connecting capacity	NF C	DIN	NF F 61-017	Rail	Tool	Torque
Wire size	Lug (NF C 20-130) Lug (DIN 46235 / 46234) Quick-connect: 6.3 x 0.8 mm	0.5 ... 4 mm²	0.5 ... 4 mm²	Type 2, TH 35-7.5, TH 35-15	Wrench Ø 7 mm Ø 0.276 in	1.2 N.m 10.6 lb.in
Rated voltage	V AC V DC	(Cat. C) 500 V (Cat. C) 500 V				
Rated current		32 A				
Rated cross section		4 mm²				

Mounting instructions

--	--	--	--	--	--	--

The use of a jumper bar requires to use a spacer instead of a circuit separator.

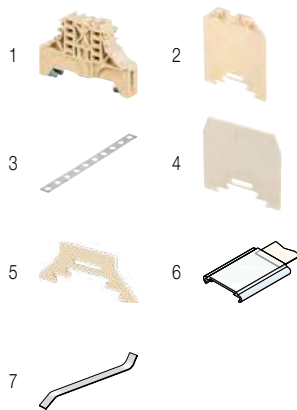

Accessories

Description	Color	Type	Part Numbers	Pkg qty	Weight (1 pce) g
1 End stops	Beige <input type="checkbox"/>	BAM2	1SNA296351R0000	50	12.00
		BAH21	1SNA167489R2200	50	8.00
2 End sections	Yellow <input type="checkbox"/>	FJHD32	1SNA205431R2600	25	
	Beige <input type="checkbox"/>	FJHD32	1SNA295431R1000	25	4.00
3 Jumper bars		BJH105	1SNA163503R2400	10	197.00
4 Circuit separators	Yellow <input type="checkbox"/>	SCHD1	1SNA205428R0300	25	
	Beige <input type="checkbox"/>	SCHD1	1SNA295428R2500	25	2.00
5 Spacers	Yellow <input type="checkbox"/>	INH1	1SNA205427R2200	25	
	Beige <input type="checkbox"/>	INH1	1SNA295427R1400	25	2.00
6 Protecting covers	Transparent <input checked="" type="checkbox"/>	CPM	1SNA187312R1400	1	25.00
	Beige <input type="checkbox"/>	CPM	1SNA197312R1600	10	25.00
	White <input type="checkbox"/>	RTC	1SNA163156R2700	1	10.00
7 Terminal block markers		PEFH	1SNA163497R1600	10	
		RPED	1SNA163518R2200	1	12.00
		RC610	1SNA233000R0100	10	7.50

HD4/10.F4.19 stud terminal blocks

Feed-through - 10.5 mm 0.413 in spacing



HD4/10.F4.19

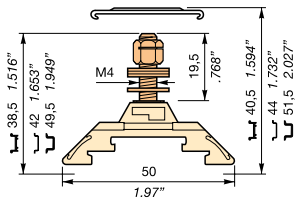

10.5 mm 0.413 in spacing

Description

- 1 stud terminal M4 x 19.5 mm 0.768 in,
- Equipment: H 130 self locking nut + TREP 3L washer + washer.

Ordering details

Description	Color	Type	Part Numbers	Pkg qty	Weight (1 pce)
1 stud M4	Beige <input type="checkbox"/>	HD4/10.F4.19	1SNA295298R0300	50	11.00

Main technical data

Connecting capacity	NF C	DIN	NF F 61-017	Rail	Tool	Torque
Wire size	Lug (NF C 20-130) Lug (DIN 46235 / 46234) Quick-connect: 6.3 x 0.8 mm	0.5 ... 4 mm ²	0.5 ... 4 mm ²	Type 2, TH 35-7.5, TH 35-15	Wrench Ø 7 mm Ø 0.276 in	1.5 N.m 13.3 lb.in
Rated voltage	V AC V DC	(Cat. C) 500 V (Cat. C) 500 V				
Rated current		32 A				
Rated cross section		4 mm ²				

Mounting instructions

--	--	--	--	--	--	--

6

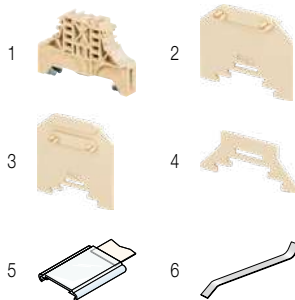

Accessories

Description	Color	Type	Part Numbers	Pkg qty	Weight (1 pce)
1 End stops	Beige <input type="checkbox"/>	BAM2	1SNA296351R0000	50	12.00
		BAH22	1SNA164655R0400	50	10.00
2 End sections	Beige <input type="checkbox"/>	FJHD40	1SNA295424R1100	25	4.00
3 Circuit separators	Beige <input type="checkbox"/>	FJDHD	1SNA295426R1300	25	4.00
		SCHD2	1SNA295429R2600	25	2.00
4 Spacers	Beige <input type="checkbox"/>	INH1	1SNA295427R1400	25	2.00
5 Protecting covers	Transparent <input checked="" type="checkbox"/>	CPM	1SNA187312R1400	1	25.00
	Beige <input type="checkbox"/>	CPM	1SNA197312R1600	10	25.00
6 Terminal block markers	White <input type="checkbox"/>	RTC	1SNA163156R2700	1	10.00
		PEFH	1SNA163497R1600	10	10.00
		RPED	1SNA163518R2200	1	12.00
	White <input type="checkbox"/>	RC610	1SNA233000R0100	10	7.50

HD10/12.F5.3 stud terminal blocks

Feed-through - 12 mm 0.473 in spacing



HD10/12.F5.3

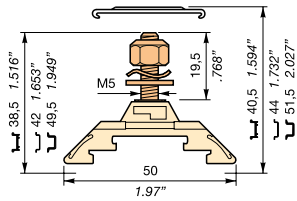

12 mm 0.473 in spacing

Description

- 1 stud terminal M5 x 19.5 mm 0.768 in,
- Equipment: self locking nut + spring washer + washer,
- NF F 61-017 designation: BD13.2-1F5 (1SNA295011R1600 + SCHD2).

Ordering details

Description	Color	Type	Part Numbers	Pkg qty	Weight (1 pce) g
1 stud M5	Beige <input type="checkbox"/>	HD10/12.F5.3	1SNA295011R1600	50	12.00

Main technical data

Connecting capacity	NF C	DIN	NF F 61-017	Rail	Tool	Torque
Wire size	Lug (NF C 20-130) Lug (DIN 46235 / 46234) Quick-connect: 6.3 x 0.8 mm	0.5 ... 10 mm ²	0.5 ... 10 mm ²	Type 2, TH 35-7.5, TH 35-15	Wrench Ø 8 mm Ø 0.315 in	2.5 N.m 22.1 lb.in
Rated voltage	V AC V DC	(Cat. C) 750 V (Cat. C) 750 V	750 V 750 V			
Rated current		57 A	51 A			
Rated cross section		10 mm ²				

Mounting instructions

CE	RoHS	EAC
<input type="checkbox"/>	<input type="checkbox"/>	<input type="checkbox"/>

The use of a jumper bar requires to use a spacer instead of a circuit separator.

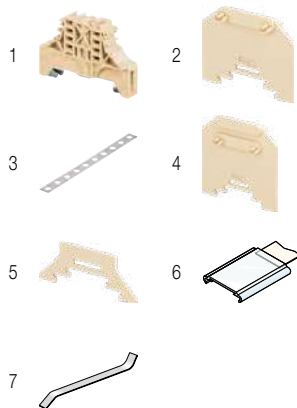

Accessories

Description	Color	Type	Part Numbers	Pkg qty	Weight (1 pce) g
1 End stops	Beige <input type="checkbox"/>	BAM2	1SNA296351R0000	50	12.00
		BAH22	1SNA164655R0400	50	10.00
2 End sections	Beige <input type="checkbox"/>	FJHD40	1SNA295424R1100	25	4.00
3 Jumper bars		BJH131-10	1SNA163468R0000	10	59.00
4 Circuit separators	Beige <input type="checkbox"/>	FJDHD	1SNA295426R1300	25	4.00
		SCHD2	1SNA295429R2600	25	2.00
5 Spacers	Beige <input type="checkbox"/>	INH1	1SNA295427R1400	25	2.00
6 Protecting covers	Transparent <input checked="" type="checkbox"/>	CPM	1SNA187312R1400	1	25.00
	Beige <input type="checkbox"/>	CPM	1SNA197312R1600	10	25.00
	White <input type="checkbox"/>	RTC	1SNA163156R2700	1	10.00
7 Terminal block markers		PEFH	1SNA163497R1600	10	
		RPED	1SNA163518R2200	1	12.00
	White <input type="checkbox"/>	RC610	1SNA233000R0100	10	7.50

HD10/12.F5 stud terminal blocks

Feed-through - 12 mm 0.473 in spacing

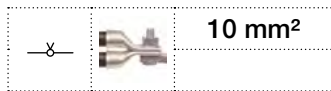

1SNC167021F0014

HD10/12.F5

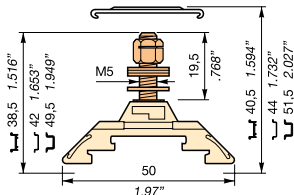

12 mm 0.473 in spacing

Description

- 1 stud terminal M5 x 19.5 mm 0.768 in,
- Equipment: H 130 self locking nut + TREP 3L washer + washer.

Ordering details

Description	Color	Type	Part Numbers	Pkg qty	Weight (1 pce)
1 stud M5	Beige <input type="checkbox"/>	HD10/12.F5	1SNA295394R2300	50	11.00

Main technical data

Connecting capacity	NF C	DIN	NF F 61-017	Rail	Tool	Torque
Wire size	Lug (NF C 20-130) Lug (DIN 46235 / 46234) Quick-connect: 6.3 x 0.8 mm	0.5 ... 10 mm ² 0.5 ... 10 mm ²		Type 2, TH 35-7.5, TH 35-15	Wrench Ø 8 mm Ø 0.315 in	2.5 N.m 22.1 lb.in
Rated voltage	V AC V DC	(Cat. C) 750 V (Cat. C) 750 V				
Rated current		57 A				
Rated cross section		10 mm ²				

Mounting instructions

--	--	--	--	--	--	--

The use of a jumper bar requires to use a spacer instead of a circuit separator.

6

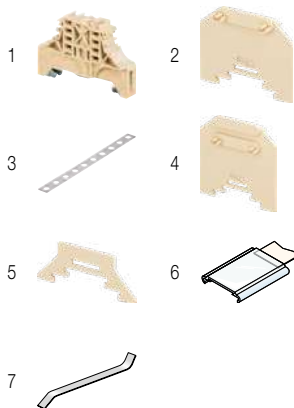

Accessories

Description	Color	Type	Part Numbers	Pkg qty	Weight (1 pce)
1 End stops	Beige <input type="checkbox"/>	BAM2	1SNA296351R0000	50	12.00
2 End sections	Beige <input type="checkbox"/>	BAH22	1SNA164655R0400	50	10.00
3 Jumper bars		BJH131-10	1SNA163468R0000	10	59.00
4 Circuit separators	Beige <input type="checkbox"/>	FJDHD	1SNA295426R1300	25	4.00
5 Spacers	Beige <input type="checkbox"/>	SCHD2	1SNA295429R2600	25	2.00
6 Protecting covers	Transparent <input checked="" type="checkbox"/>	INHD1	1SNA295427R1400	25	2.00
7 Terminal block markers	Beige <input type="checkbox"/>	CPM	1SNA187312R1400	1	25.00
	White <input type="checkbox"/>	CPM	1SNA197312R1600	10	25.00
		RTC	1SNA163156R2700	1	10.00
		PEFH	1SNA163497R1600	10	
		RPED	1SNA163518R2200	1	12.00
	White <input type="checkbox"/>	RC610	1SNA233000R0100	10	7.50

HD10/12.F5 stud terminal blocks

Feed-through - 12 mm 0.473 in spacing



HD10/12.F5

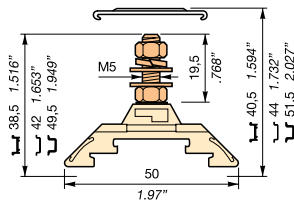

12 mm 0.473 in spacing

Description

- 1 stud terminal M5 x 19.5 mm 0.768 in,
- Equipment: 1 bottom nut + 2 washers + 1 spring washer + 1 top nut.

Ordering details

Description	Color	Type	Part Numbers	Pkg qty	Weight (1 pce) g
1 stud M5	Beige	HD10/12.F5.1	1SNA295395R2400	50	11.00
	Beige	HD10/12.F5.2	1SNA295396R2500	50	11.00
	Yellow	HD10/12.F5.2	1SNA205396R0300	50	11.00

Main technical data

Connecting capacity	NF C	DIN	NF F 61-017	Rail	Tool	Torque
Wire size	Lug (NF C 20-130) Lug (DIN 46235 / 46234) Quick-connect: 6.3 x 0.8 mm	0.5 ... 10 mm ²	0.5 ... 10 mm ²	Type 2, TH 35-7.5, TH 35-15	Wrench Ø 8 mm Ø 0.315 in	2 N.m 17.7 lb.in
Rated voltage	V AC V DC	(Cat. C) 750 V (Cat. C) 750 V				
Rated current		57 A				
Rated cross section		10 mm ²				

Mounting instructions

--	--	--	--	--	--	--

The use of a jumper bar requires to use a spacer instead of a circuit separator.

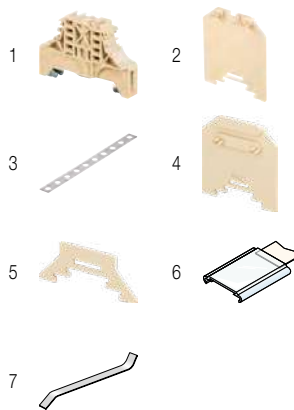

Accessories

Description	Color	Type	Part Numbers	Pkg qty	Weight (1 pce) g
1 End stops	Beige	BAM2	1SNA296351R0000	50	12.00
	Beige	BAH22	1SNA164655R0400	50	10.00
2 End sections	Yellow	FJHD40	1SNA205424R2700	25	4.00
	Beige	FJHD40	1SNA295424R1100	25	59.00
3 Jumper bars		BJH131-10	1SNA163468R0000	10	4.00
4 Circuit separators	Beige	FJDHD	1SNA295426R1300	25	2.00
	Yellow	SCHD2	1SNA205429R0400	25	2.00
5 Spacers	Beige	SCHD2	1SNA295429R2600	25	2.00
	Yellow	INH1	1SNA205427R2200	25	2.00
6 Protecting covers	Beige	INH1	1SNA295427R1400	25	25.00
	Transparent	CPM	1SNA187312R1400	1	25.00
7 Terminal block markers	Beige	CPM	1SNA197312R1600	10	10.00
	White	RTC	1SNA163156R2700	1	12.00
		PEFH	1SNA163497R1600	1	7.50
		RPED	1SNA163518R2200	1	
		White	RC610	1SNA233000R0100	10

HD35/16.F6.19 stud terminal blocks

Feed-through - 16 mm 0.63 in spacing



HD35/16.F6.19

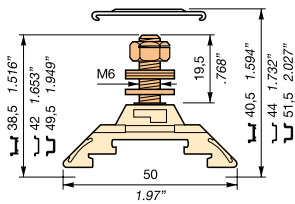

16 mm 0.63 in spacing

Description

- 1 stud terminal M6 x 19.5 mm 0.768 in,
- Equipment: H 130 self locking nut + TREP 3L washer + washer,
- NF F 61-017 designation: BD17.2-1F6 (1SNA295398R0700 + SCHD2).

Ordering details

Description	Color	Type	Part Numbers	Pkg qty	Weight (1 pce) g
1 stud M6	Beige <input type="checkbox"/>	HD35/16.F6.19	1SNA295398R0700	50	17.00

Main technical data

Connecting capacity	NF C	DIN	NF F 61-017
Wire size	Lug (NF C 20-130) Lug (DIN 46235 / 46234) Quick-connect: 6.3 x 0.8 mm	1.5 ... 35 mm ² 2.5 ... 35 mm ²	
Rated voltage	V AC V DC	(Cat. C) 750 V (Cat. C) 750 V	750 V 750 V
Rated current		125 A	125 A
Rated cross section		35 mm ²	

Mounting instructions

Rail	Tool	Torque
Type 2, TH 35-7.5, TH 35-15		Wrench Ø 10 mm Ø 0.394 in
		5.3 N.m 46.9 lb.in

--	--	--

The use of a jumper bar requires to use a spacer instead of a circuit separator.

6

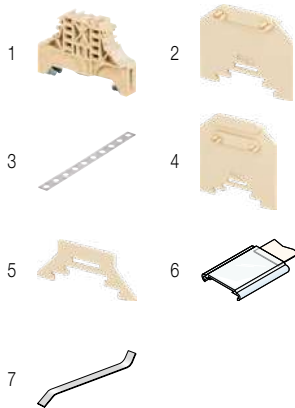

Accessories

Description	Color	Type	Part Numbers	Pkg qty	Weight (1 pce) g
1 End stops	Beige <input type="checkbox"/>	BAM2	1SNA296351R0000	50	12.00
2 End sections	Beige <input type="checkbox"/>	BAH22	1SNA164655R0400	50	10.00
3 Jumper bars		BJH17	1SNA163475R2700	10	99.00
4 Circuit separators	Beige <input type="checkbox"/>	FJDHD	1SNA295426R1300	25	4.00
5 Spacers	Beige <input type="checkbox"/>	SCHD2	1SNA295429R2600	25	2.00
6 Protecting covers	Transparent <input checked="" type="checkbox"/>	INHD1	1SNA295427R1400	25	2.00
7 Terminal block markers	Beige <input type="checkbox"/>	CPM	1SNA187312R1400	1	25.00
	White <input type="checkbox"/>	CPM	1SNA197312R1600	10	25.00
		RTC	1SNA163156R2700	1	10.00
		PEFH	1SNA163497R1600	10	
		RPED	1SNA163518R2200	1	12.00
	White <input type="checkbox"/>	RC610	1SNA233000R0100	10	7.50

HD35/16.F6.19.1 stud terminal blocks

Feed-through - 16 mm 0.63 in spacing



35 mm²

Description

- 1 stud terminal M6 x 19.5 mm 0.768 in,
- Equipment: 1 bottom nut + 2 washers + 1 spring washer + 1 top nut.

Ordering details

Description	Color	Type	Part Numbers	Pkg qty	Weight (1 pce) g
1 stud M6	Beige <input type="checkbox"/>	HD35/16.F6.19.1	1SNA295399R0000	50	17.00

Main technical data

Connecting capacity	NF C	DIN	NF F 61-017
Wire size	Lug (NF C 20-130) Lug (DIN 46235 / 46234) Quick-connect: 6.3 x 0.8 mm	1.5 ... 35 mm ² 2.5 ... 35 mm ²	
Rated voltage	V AC V DC	(Cat. C) 750 V (Cat. C) 750 V	
Rated current		125 A	
Rated cross section		35 mm ²	

Mounting instructions

Rail	Tool	Torque
Type 2, TH 35-7.5, TH 35-15	Wrench Ø 10 mm Ø 0.394 in	3 N.m 26.6 lb.in

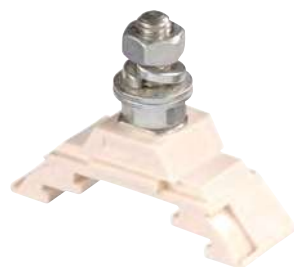

1SNC167039F001.4

HD35/16.F6.19.1

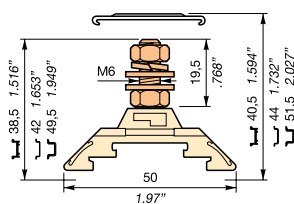

16 mm 0.63 in spacing

The use of a jumper bar requires to use a spacer instead of a circuit separator.

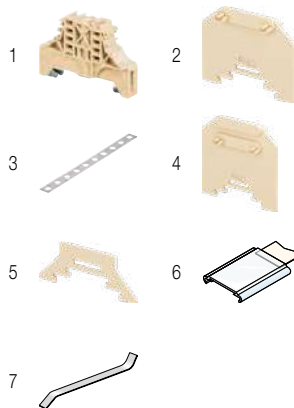

Accessories

Description	Color	Type	Part Numbers	Pkg qty	Weight (1 pce) g
1 End stops	Beige <input type="checkbox"/>	BAM2	1SNA296351R0000	50	12.00
		BAH22	1SNA164655R0400	50	10.00
2 End sections	Beige <input type="checkbox"/>	FJHD40	1SNA295424R1100	25	4.00
3 Jumper bars		BJH17	1SNA163475R2700	10	99.00
4 Circuit separators	Beige <input type="checkbox"/>	FJDHD	1SNA295426R1300	25	4.00
		SCHD2	1SNA295429R2600	25	2.00
5 Spacers	Beige <input type="checkbox"/>	INH1	1SNA295427R1400	25	2.00
6 Protecting covers	Transparent <input checked="" type="checkbox"/>	CPM	1SNA187312R1400	1	25.00
	Beige <input type="checkbox"/>	CPM	1SNA197312R1600	10	25.00
	White <input type="checkbox"/>	RTC	1SNA163156R2700	1	10.00
7 Terminal block markers		PEFH	1SNA163497R1600	10	
		RPED	1SNA163518R2200	1	12.00
	White <input type="checkbox"/>	RC610	1SNA233000R0100	10	7.50

HD70/22.F8 stud terminal blocks

Feed-through - 22 mm 0.866 in spacing



1SNC1671110014

HD70/22.F8

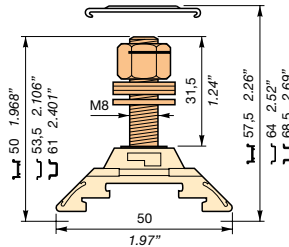

22 mm 0.866 in spacing

Description

- 1 stud terminal M8 x 31.5 mm 1.24 in,
- Equipment: H 130 self locking nut + TREP 3L washer + washer,
- NF F 61-017 designation: BD23.2-1F8 (1SNA295400R0600 + SCH8).

Ordering details

Description	Color	Type	Part Numbers	Pkg qty	Weight (1 pce) g
1 stud M8	Beige <input type="checkbox"/>	HD70/22.F8.31	1SNA295400R0600	50	39.00

Main technical data

Connecting capacity	NF C	DIN	NF F 61-017	Rail	Tool	Mounting instructions
Wire size	Lug (NF C 20-130) Lug (DIN 46235 / 46234) Quick-connect: 6.3 x 0.8 mm	1.5 ... 70 mm²	2.5 ... 50 mm²			Type 2, TH 35-7.5, TH 35-15 Wrench Ø 13 mm Ø 0.512 in
Rated voltage	V AC V DC	(Cat. C) 750 V (Cat. C) 750 V	750 V 750 V			
Rated current		192 A	188 A	Torque		13.4 N.m 118.6 lb.in
Rated cross section		70 mm²				

--	--	--	--	--	--	--

The use of a jumper bar requires to use a spacer instead of a circuit separator.

Accessories

Description	Color	Type	Part Numbers	Pkg qty	Weight (1 pce) g
1 End stops	Beige <input type="checkbox"/>	BAM2	1SNA296351R0000	50	12.00
2 End sections	Beige <input type="checkbox"/>	BAH24	1SNA168355R1300	50	12.00
3 Jumper bars		BJH23-10	1SNA163476R2000	10	185.00
4 Circuit separators	Beige <input type="checkbox"/>	SCH8	1SNA199412R1500	25	4.80
5 Spacers	Beige <input type="checkbox"/>	INH1	1SNA295427R1400	25	2.00
6 Protecting covers	Transparent <input checked="" type="checkbox"/>	CPM	1SNA187312R1400	1	25.00
	Beige <input type="checkbox"/>	CPM	1SNA197312R1600	10	25.00
7 Terminal block markers	White <input type="checkbox"/>	RTC	1SNA163156R2700	1	10.00
		PEFH	1SNA163497R1600	10	12.00
		RPED	1SNA163518R2200	1	12.00
	White <input type="checkbox"/>	RC610	1SNA233000R0100	10	7.50

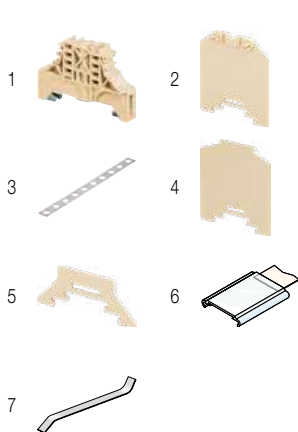

HD120/30.F10.31 stud terminal blocks

Feed-through - 30 mm 1.18 in spacing



1SNC167059/0014

HD120/30.F10.31

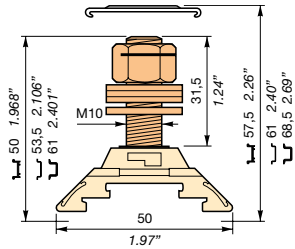

30 mm 1.18 in spacing

Description

- 1 stud terminal M10 x 31.5 mm 1.24 in,
- Equipment: H 130 self locking nut + TREP 3L washer + washer.

Ordering details

Description	Color	Type	Part Numbers	Pkg qty	Weight (1 pce)
1 stud M10	Beige <input type="checkbox"/>	HD120/30.F10.31	1SNA295448R0100	10	60.00

Main technical data

Connecting capacity	NF C	DIN	NF F 61-017	Rail	Tool	Mounting instructions
Wire size	Lug (NF C 20-130) Lug (DIN 46235 / 46234) Quick-connect: 6.3 x 0.8 mm	10 ... 120 mm² 6 ... 120 mm²				Type 2, TH 35-7.5, TH 35-15 Wrench Ø 16 mm Ø 0.63 in
Rated voltage	V AC V DC	(Cat. C) 750 V (Cat. C) 750 V			Torque	30 N.m 265.5 lb.in
Rated current		269 A				
Rated cross section		120 mm²				

--	--	--	--	--	--	--

The use of a jumper bar requires to use a spacer instead of a circuit separator.

Accessories

Description	Color	Type	Part Numbers	Pkg qty	Weight (1 pce)
1 End stops	Beige <input type="checkbox"/>	BAM2	1SNA296351R0000	50	12.00
2 End sections	Beige <input type="checkbox"/>	BAH24	1SNA168355R1300	50	12.00
3 Jumper bars		BJH311	1SNA163479R0300	10	233.00
4 Circuit separators	Beige <input type="checkbox"/>	SCH8	1SNA199412R1500	25	4.80
5 Spacers	Beige <input type="checkbox"/>	INH1	1SNA295427R1400	25	2.00
6 Protecting covers	Transparent <input checked="" type="checkbox"/>	CPM	1SNA187312R1400	1	25.00
	Beige <input type="checkbox"/>	CPM	1SNA197312R1600	10	25.00
7 Terminal block markers	White <input type="checkbox"/>	RTC	1SNA163156R2700	1	10.00
		PEFH	1SNA163497R1600	10	10.00
		RPED	1SNA163518R2200	1	12.00
	White <input type="checkbox"/>	RC610	1SNA233000R0100	10	7.50

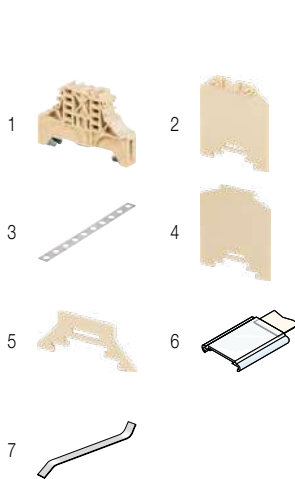

HD120/30.F10.31.1 stud terminal blocks

Feed-through - 30 mm 1.18 in spacing



120 mm²

Description

- 1 stud terminal M10 x 31.5 mm 1.24 in,
- Equipment: 1 bottom nut + 2 washers + 1 spring washer + 1 top nut.



1SNC167112V0014

HD120/30.F10.31.1

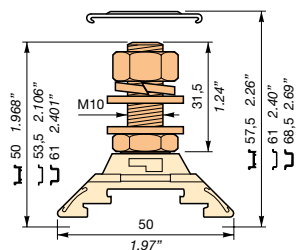

30 mm 1.18 in spacing

Ordering details

Description	Color	Type	Part Numbers	Pkg qty	Weight (1 pce) g
1 stud M10	Beige <input type="checkbox"/>	HD120/30.F10.31.1	1SNA295403R2500	10	60.00

Main technical data

Connecting capacity		NF C	DIN	NF F 61-017	Mounting instructions	
Wire size	Lug (NF C 20-130)	10 ... 120 mm ²			Rail	Type 2, TH 35-7.5, TH 35-15
	Lug (DIN 46235 / 46234)		6 ... 120 mm ²		Tool	Wrench Ø 16 mm Ø 0.63 in
	Quick-connect: 6.3 x 0.8 mm					
Rated voltage	V AC	(Cat. C) 750 V			Torque	10 N.m 88.5 lb.in
	V DC	(Cat. C) 750 V				
Rated current		269 A				
Rated cross section		120 mm ²				

--	--	--	--	--	--	--

The use of a jumper bar requires to use a spacer instead of a circuit separator.

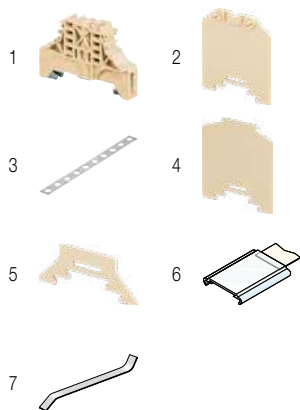

Accessories

Description	Color	Type	Part Numbers	Pkg qty	Weight (1 pce) g
1 End stops	Beige <input type="checkbox"/>	BAM2	1SNA296351R0000	50	12.00
		BAH24	1SNA168355R1300	50	12.00
2 End sections	Beige <input type="checkbox"/>	FJH501	1SNA199411R1400	25	6.50
3 Jumper bars		BJH311	1SNA163479R0300	10	233.00
4 Circuit separators	Beige <input type="checkbox"/>	SCH8	1SNA199412R1500	25	4.80
5 Spacers	Beige <input type="checkbox"/>	INH1	1SNA295427R1400	25	2.00
6 Protecting covers	Transparent <input checked="" type="checkbox"/>	CPM	1SNA187312R1400	1	25.00
	Beige <input type="checkbox"/>	CPM	1SNA197312R1600	10	25.00
7 Terminal block markers	White <input type="checkbox"/>	RTC	1SNA163156R2700	1	10.00
		PEFH	1SNA163497R1600	10	
		RPED	1SNA163518R2200	1	12.00
	White <input type="checkbox"/>	RC610	1SNA233000R0100	10	7.50

1SNC167059S0201

HD185/36.F12.31.1 stud terminal blocks

Feed-through - 36 mm 1.42 in spacing



HD185/36.F12.31.1

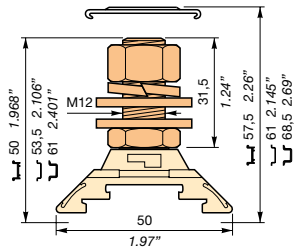

36 mm 1.42 in spacing

Description

- 1 stud terminal M12 x 31.5 mm 1.24 in,
- Equipment: 1 bottom nut + 2 washers + 1 spring washer + 1 top nut.

Ordering details

Description	Color	Type	Part Numbers	Pkg qty	Weight (1 pce)
1 stud M12	Beige <input type="checkbox"/>	HD185/36.F12.31.1	1SNA295405R2700	10	79.00

Main technical data

Connecting capacity	NF C	DIN	NF F 61-017	Rail	Tool	Torque
Wire size	Lug (NF C 20-130) Lug (DIN 46235 / 46234) Quick-connect: 6.3 x 0.8 mm	35 ... 185 mm² 10 ... 150 mm²		Type 2, TH 35-7.5, TH 35-15	Wrench Ø 18 mm Ø 0.709 in	14 N.m 123.9 lb.in
Rated voltage	V AC V DC	(Cat. C) 750 V (Cat. C) 750 V				
Rated current		353 A				
Rated cross section		185 mm²				

--	--	--	--	--	--	--

Accessories

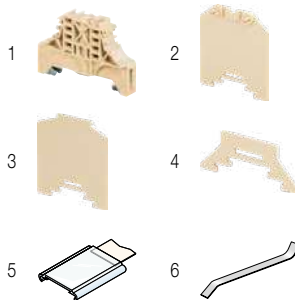

Description	Color	Type	Part Numbers	Pkg qty	Weight (1 pce)
1 End stops	Beige <input type="checkbox"/>	BAM2	1SNA296351R0000	50	12.00
		BAH24	1SNA168355R1300	50	12.00
2 End sections	Beige <input type="checkbox"/>	FJH501	1SNA199411R1400	25	6.50
3 Circuit separators	Beige <input type="checkbox"/>	SCH8	1SNA199412R1500	25	4.80
4 Spacers	Beige <input type="checkbox"/>	INHD1	1SNA295427R1400	25	2.00
5 Protecting covers	Transparent <input checked="" type="checkbox"/>	CPM	1SNA187312R1400	1	25.00
	Beige <input type="checkbox"/>	CPM	1SNA197312R1600	10	25.00
6 Terminal block markers	White <input type="checkbox"/>	RTC	1SNA163156R2700	1	10.00
		PEFH	1SNA163497R1600	10	
		RPED	1SNA163518R2200	1	12.00
	White <input type="checkbox"/>	RC610	1SNA233000R0100	10	7.50

HD4/9.FF4 stud terminal blocks

Feed-through - 9.5 mm 0.374 in spacing



4 mm²

Description

- 2 stud terminals M4 x 11 mm 0.433 in,
- Equipment: self locking nut + spring washer + washer.



1SNC167110V0014

HD4/9.FF4

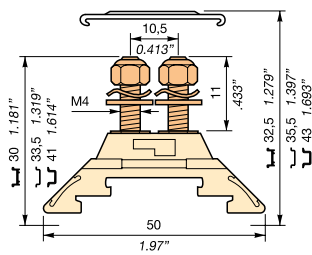

9.5 mm 0.374 in spacing

Ordering details

Description	Color	Type	Part Numbers	Pkg qty	Weight (1 pce) g
2 studs M4	Beige <input type="checkbox"/>	HD4/9.FF4	1SNA295393R2200	100	6.00

Main technical data

Connecting capacity	NF C	DIN	NF F 61-017	Rail	Tool	Torque
Wire size	Lug (NF C 20-130) Lug (DIN 46235 / 46234) Quick-connect: 6.3 x 0.8 mm	0.5 ... 4 mm ²	0.5 ... 4 mm ²	Type 2, TH 35-7.5, TH 35-15	Wrench Ø 7 mm Ø 0.276 in	1.2 N.m 10.6 lb.in
Rated voltage	V AC V DC	(Cat. C) 500 V (Cat. C) 500 V				
Rated current		32 A				
Rated cross section		4 mm ²				

Mounting instructions

--	--	--	--	--	--	--

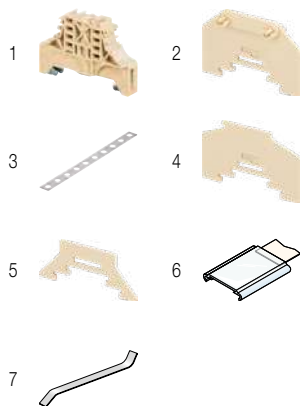

Accessories

Description	Color	Type	Part Numbers	Pkg qty	Weight (1 pce) g
1 End stops	Beige <input type="checkbox"/>	BAM2	1SNA296351R0000	50	12.00
2 End sections	Beige <input type="checkbox"/>	BAH22	1SNA164655R0400	50	10.00
3 Jumper bars		FJHD32	1SNA295431R1000	25	4.00
4 Circuit separators	Beige <input type="checkbox"/>	BJH105	1SNA163503R2400	10	197.00
5 Spacers	Beige <input type="checkbox"/>	SCHD1	1SNA295428R2500	25	2.00
6 Protecting covers	Beige <input type="checkbox"/>	INHD1	1SNA295427R1400	25	2.00
7 Terminal block markers	Transparent <input checked="" type="checkbox"/>	CPM	1SNA187312R1400	1	25.00
	Beige <input type="checkbox"/>	CPM	1SNA197312R1600	10	25.00
	White <input type="checkbox"/>	RTC	1SNA163156R2700	1	10.00
		PEFH	1SNA163497R1600	10	10.00
	RPED	1SNA163518R2200	1	12.00	
	White <input type="checkbox"/>	RC610	1SNA233000R0100	10	7.50

6

1SNC167066S0201

HD6/13.FF4 stud terminal blocks

Feed-through - 13 mm 0.512 in spacing

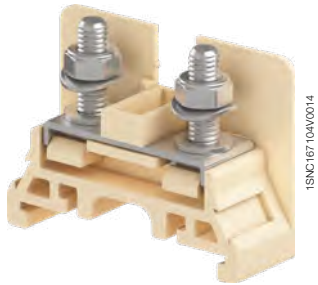
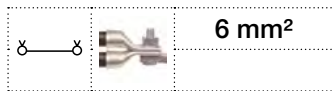

HD6/13.FF4

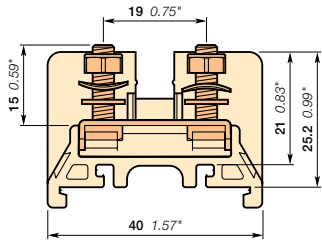

13 mm 0.512 in spacing

Description

- 2 stud terminals M4 x 15 mm 0.531 in,
- Equipment: self locking nut + spring washer + washer,
- NF F 61-017 designation: BE0013-FF4 (1SNA295014R1100).

Ordering details

Description	Color	Type	Part Numbers	Pkg qty	Weight (1 pce) g
2 studs M4	Beige <input type="checkbox"/>	HD6/13.FF4	1SNA295014R1100	10	15.00

Main technical data

Connecting capacity	NF C	DIN	NF F 61-017	Rail	Tool	Torque
Wire size	Lug (NF C 20-130) Lug (DIN 46235 / 46234) Quick-connect: 6.3 x 0.8 mm	0.5 ... 6 mm ²	0.5 ... 6 mm ²	Type 2, TH 35-7.5, TH 35-15	Wrench Ø 7 mm Ø 0.276 in	1.2 N.m 10.6 lb.in
Rated voltage	V AC V DC	(Cat. C) 400 V (Cat. C) 250 V	(Cat. C) 380 V (Cat. C) 450 V 380 V			
Rated current		51 A	47 A			
Rated cross section		6 mm ²				

Mounting instructions

CE	RoHS	RoHS	EAC	EAC															
----	------	------	-----	-----	--	--	--	--	--	--	--	--	--	--	--	--	--	--	--

Accessories

Description	Color	Type	Part Numbers	Pkg qty	Weight (1 pce) g
1 End stops	Beige <input type="checkbox"/>	BAM2	1SNA296351R0000	50	12.00
		BAH21	1SNA167489R2200	50	8.00
2 End sections	Beige <input type="checkbox"/>	FEH8	1SNA198729R0100	25	4.30
3 Jumper bars		BJS13-10	1SNA167224R2700	10	10.00
4 Circuit separators	Beige <input type="checkbox"/>	SCH8	1SNA199412R1500	25	4.80
5 Terminal block markers	White <input type="checkbox"/>	REH3	1SNA163155R2600	1	20.00

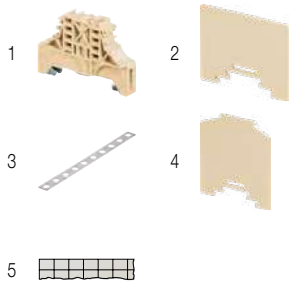

HD10/12.FF5 stud terminal blocks

Feed-through - 12 mm 0.473 in spacing



10 mm²

Description

- 2 stud terminals M5 x 19.5 mm 0.768 in,
- Equipment: H 130 self locking nut + TREP 3L washer + washer.

Ordering details

Description	Color	Type	Part Numbers	Pkg qty	Weight (1 pce) g
2 studs M5	Beige <input type="checkbox"/>	HD10/12.FF5	1SNA295397R2600	50	11.00

Main technical data

Connecting capacity		NF C	DIN	NF F 61-017	Mounting instructions	
Wire size	Lug (NF C 20-130)	0.5 ... 10 mm ²			Rail	Type 2, TH 35-7.5, TH 35-15
	Lug (DIN 46235 / 46234)		0.5 ... 10 mm ²		Tool	Wrench Ø 8 mm Ø 0.315 in
	Quick-connect: 6.3 x 0.8 mm					
Rated voltage	V AC	(Cat. C) 750 V			Torque	2.5 N.m 22.1 lb.in
	V DC	(Cat. C) 750 V				
Rated current		57 A				
Rated cross section		10 mm ²				



1SNIC167098V001.4

HD10/12.FF5

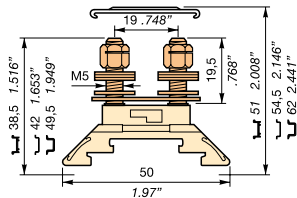

12 mm 0.473 in spacing

--	--	--	--	--	--	--	--	--	--	--

The use of a jumper bar requires to use a spacer instead of a circuit separator.

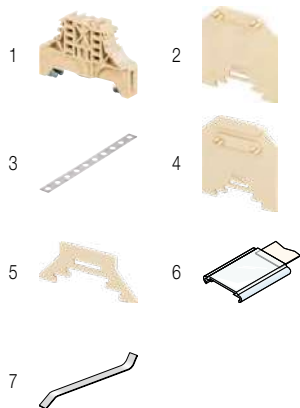

Accessories

Description	Color	Type	Part Numbers	Pkg qty	Weight (1 pce) g
1 End stops	Beige <input type="checkbox"/>	BAM2	1SNA296351R0000	50	12.00
		BAH22	1SNA164655R0400	50	10.00
2 End sections	Beige <input type="checkbox"/>	FJHD50	1SNA295425R1200	25	4.00
3 Jumper bars		BJH131-10	1SNA163468R0000	10	59.00
4 Circuit separators	Beige <input type="checkbox"/>	FJDHD	1SNA295426R1300	25	4.00
		SCHD5	1SNA295430R2300	25	2.00
5 Spacers	Beige <input type="checkbox"/>	INH1	1SNA295427R1400	25	2.00
6 Protecting covers	Transparent <input checked="" type="checkbox"/>	CPM	1SNA187312R1400	1	25.00
		CPM	1SNA197312R1600	10	25.00
		RTC	1SNA163156R2700	1	10.00
		PEFH	1SNA163497R1600	10	
		RPED	1SNA163518R2200	1	12.00
7 Terminal block markers	White <input type="checkbox"/>	RC610	1SNA233000R0100	10	7.50

HD16/14.FF5.21.3 stud terminal blocks

Feed-through - 14 mm 0.551 in spacing

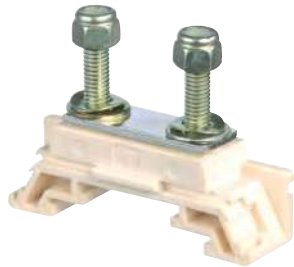
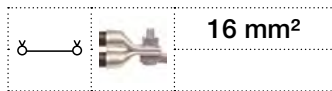

1SNC167020FC014

HD16/14.FF5.21.3

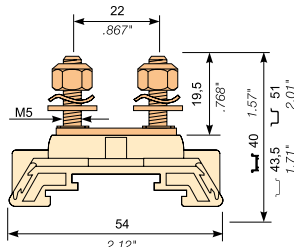

14 mm 0.551 in spacing

Description

- 2 stud terminals M5 x 19.5 mm 0.768 in,
- Equipment: self locking nut + spring washer + washer,
- 18 mm 0.709 in spacing adding SCH6 or INH3,
- Two jumpering options: 14 mm 0.551 in spacing with BJH14 and 18 mm 0.709 in spacing (adding INH3) with BJH18,
- NF F 61-017 designation: BE0018-FF5 (1SNA295012R1700 + SCH6 or INH3).

Ordering details

Description	Color	Type	Part Numbers	Pkg qty	Weight (1 pce) g
2 studs M5	Beige <input type="checkbox"/>	HD16/14.FF5.21.3	1SNA295012R1700	25	24.00

Main technical data

Connecting capacity		NF C	DIN	NF F 61-017
Wire size	Lug (NF C 20-130)	0.5 ... 16 mm²		
	Lug (DIN 46235 / 46234)		0.5 ... 16 mm²	
	Quick-connect: 6.3 x 0.8 mm			
Rated voltage	V AC	(Cat. C) 500 V	(Cat. C) 500 V	380 V
	V DC	(Cat. C) 500 V	(Cat. C) 600 V	500 V
Rated current		71 A	65 A	71 A
Rated cross section		16 mm²		

Mounting instructions

Rail		Type 2, TH 35-7.5, TH 35-15
Tool		Wrench Ø 8 mm Ø 0.315 in
Torque		2.5 N.m 22.1 lb.in

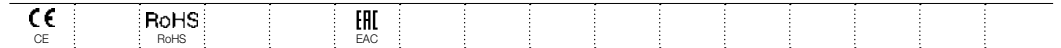

The use of a jumper bar requires to use a spacer instead of a circuit separator.

6

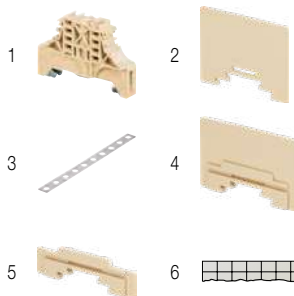

Accessories

Description	Color	Type	Part Numbers	Pkg qty	Weight (1 pce) g	
1 End stops	Beige <input type="checkbox"/>	BAM2	1SNA296351R0000	50	12.00	
		BAH22	1SNA164655R0400	50	10.00	
2 End sections	Beige <input type="checkbox"/>	FEH8	1SNA198729R0100	25	4.30	
3 Jumper bars		2 poles	BJH14-2	1SNA173438R2400	1	5.30
		3 poles	BJH14-3	1SNA173439R2500	10	8.30
		4 poles	BJH14-4	1SNA173441R2700	10	11.20
		5 poles	BJH14-5	1SNA173449R0700	10	14.20
		10 poles	BJH14-10	1SNA173451R2100	1	28.00
		2 poles	BJH18-2	1SNA173452R2200	1	6.20
		3 poles	BJH18-3	1SNA173453R2300	1	9.90
		4 poles	BJH18-4	1SNA173454R2400	1	13.80
		5 poles	BJH18-5	1SNA173460R0600	1	17.50
		10 poles	BJH18-10	1SNA173461R2300	1	36.90
4 Circuit separators	Beige <input type="checkbox"/>	SCH6	1SNA199393R2200	20		
5 Spacers	Beige <input type="checkbox"/>	INH3	1SNA199394R2300	25	2.60	
6 Terminal block markers	White <input type="checkbox"/>	REH3	1SNA163155R2600	1	20.00	
		RC610	1SNA233000R0100	10	7.50	

HD16/14.FF5.20.3 stud terminal blocks

Feed-through - 14 mm 0.551 in spacing

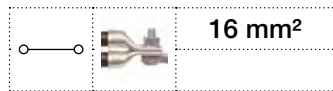

HD16/14.FF5.20.3

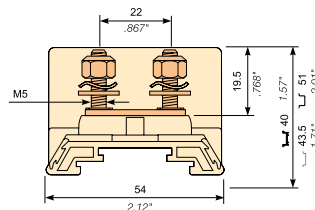

14 mm 0.551 in spacing

Description

- 2 stud terminals M5 x 19.5 mm 0.768 in,
- Equipment: self locking nut + spring washer + washer,
- NF F 61-017 designation: BE0014-FF5 (1SNA295013R1000).

Ordering details

Description	Color	Type	Part Numbers	Pkg qty	Weight (1 pce) g
2 studs M5	Beige <input type="checkbox"/>	HD16/14.FF5.20.3	1SNA295013R1000	25	26.00

Main technical data

Connecting capacity	NF C	DIN	NF F 61-017	Rail	Tool	Torque
Wire size	Lug (NF C 20-130) Lug (DIN 46235 / 46234) Quick-connect: 6.3 x 0.8 mm	0.5 ... 16 mm ²	0.5 ... 16 mm ²	Type 2, TH 35-7.5, TH 35-15	Wrench Ø 8 mm Ø 0.315 in	2.5 N.m 22.1 lb.in
Rated voltage	V AC V DC	(Cat. C) 500 V (Cat. C) 500 V	(Cat. C) 500 V (Cat. C) 600 V	380 V 500 V		
Rated current		71 A	65 A	51 A		
Rated cross section		16 mm ²				

Mounting instructions

CE	RoHS	EAC
<input type="checkbox"/>	<input type="checkbox"/>	<input type="checkbox"/>

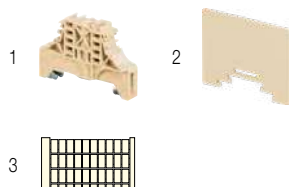

Accessories

Description	Color	Type	Part Numbers	Pkg qty	Weight (1 pce) g
1 End stops	Beige <input type="checkbox"/>	BAM2	1SNA296351R0000	50	12.00
		BAH22	1SNA164655R0400	50	10.00
2 End sections	Beige <input type="checkbox"/>	FEH8	1SNA198729R0100	25	4.30
3 Terminal block markers	White <input type="checkbox"/>	RC610	1SNA233000R0100	10	7.50

HD16/14.FF5.21 stud terminal blocks

Feed-through - 14 mm 0.551 in spacing

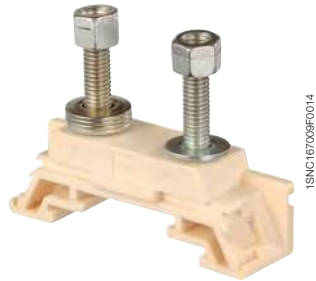
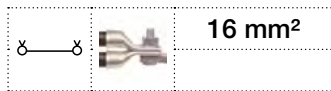

1SNC167024S0201

HD16/14.FF5.21

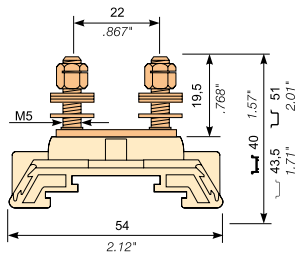

14 mm 0.551 in spacing

Description

- 2 stud terminals M5 x 19.5 mm 0.768 in,
- Equipment: H 130 self locking nut + TREP 3L washer + washer,
- 18 mm 0.709 in spacing adding SCH6 or INH3,
- Two jumpering options: 14 mm 0.551 in spacing with BJH14 and 18 mm 0.709 in spacing (adding INH3) with BJH18.

Ordering details

Description	Color	Type	Part Numbers	Pkg qty	Weight (1 pce) g
2 studs M5	Beige <input type="checkbox"/>	HD16/14.FF5.21	1SNA162991R1400	25	30.00

Main technical data

Connecting capacity	NF C	DIN	NF F 61-017	Rail	Tool	Torque
Wire size	Lug (NF C 20-130) Lug (DIN 46235 / 46234) Quick-connect: 6.3 x 0.8 mm	0.5 ... 16 mm²	0.5 ... 16 mm²	Type 2, TH 35-7.5, TH 35-15	Wrench Ø 8 mm Ø 0.315 in	2.5 N.m 22.1 lb.in
Rated voltage	V AC V DC	(Cat. C) 500 V (Cat. C) 500 V	(Cat. C) 500 V (Cat. C) 600 V			
Rated current		71 A	65 A			
Rated cross section		16 mm²				

Mounting instructions



The use of a jumper bar requires to use a spacer instead of a circuit separator.

6

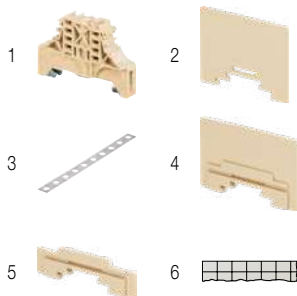

Accessories

Description	Color	Type	Part Numbers	Pkg qty	Weight (1 pce) g
1 End stops	Beige <input type="checkbox"/>	BAM2	1SNA296351R0000	50	12.00
		BAH22	1SNA164655R0400	50	10.00
2 End sections	Beige <input type="checkbox"/>	FEH8	1SNA198729R0100	25	4.30
3 Jumper bars		BJH14-2	1SNA173438R2400	1	5.30
		BJH14-3	1SNA173439R2500	10	8.30
		BJH14-4	1SNA173441R2700	10	11.20
		BJH14-5	1SNA173449R0700	10	14.20
		BJH14-10	1SNA173451R2100	1	28.00
		BJH18-2	1SNA173452R2200	1	6.20
		BJH18-3	1SNA173453R2300	1	9.90
		BJH18-4	1SNA173454R2400	1	13.80
		BJH18-5	1SNA173460R0600	1	17.50
		BJH18-10	1SNA173461R2300	1	36.90
4 Circuit separators	Beige <input type="checkbox"/>	SCH6	1SNA199393R2200	20	
5 Spacers	Beige <input type="checkbox"/>	INH3	1SNA199394R2300	25	2.60
6 Terminal block markers	White <input type="checkbox"/>	REH3	1SNA163155R2600	1	20.00
		RC610	1SNA233000R0100	10	7.50

HD16/14.FF5.20 stud terminal blocks

Feed-through - 14 mm 0.551 in spacing

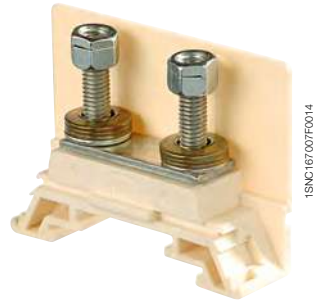

HD16/14.FF5.20

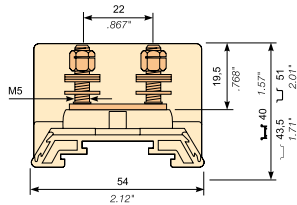

14 mm 0.551 in spacing

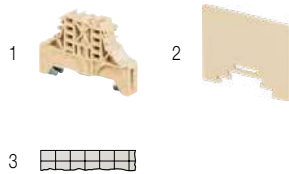

Description

- 2 stud terminals M5 x 19.5 mm 0.768 in,
- Equipment: H 130 self locking nut + TREP 3L washer + washer.

Ordering details

Description	Color	Type	Part Numbers	Pkg qty	Weight (1 pce) g
2 studs M5	Beige <input type="checkbox"/>	HD16/14.FF5.20	1SNA162979R0700	25	27.00

Main technical data

Connecting capacity	NF C	DIN	NF F 61-017
Wire size	Lug (NF C 20-130) Lug (DIN 46235 / 46234) Quick-connect: 6.3 x 0.8 mm	0.5 ... 16 mm ² 0.5 ... 16 mm ²	
Rated voltage	V AC V DC	(Cat. C) 500 V (Cat. C) 500 V	(Cat. C) 500 V 380 V (Cat. C) 600 V 500 V
Rated current		71 A	65 A 51 A
Rated cross section		16 mm ²	

Mounting instructions

Rail		Type 2, TH 35-7.5, TH 35-15
Tool		Wrench Ø 8 mm Ø 0.315 in
Torque		2.5 N.m 22.1 lb.in

--	--	--	--	--	--	--	--	--	--	--	--	--	--	--	--	--	--	--	--

Accessories

Description	Color	Type	Part Numbers	Pkg qty	Weight (1 pce) g
1 End stops	Beige <input type="checkbox"/>		BAM2	1SNA296351R0000	50 12.00
			BAH22	1SNA164655R0400	50 10.00
2 End sections	Beige <input type="checkbox"/>		FEH8	1SNA198729R0100	25 4.30
3 Terminal block markers	White <input type="checkbox"/>		REH3	1SNA163155R2600	1 20.00
			RC610	1SNA233000R0100	10 7.50

1SNC167017S0201

D35/27.FF power terminal blocks

Feed-through - 27 mm 1.062 in spacing

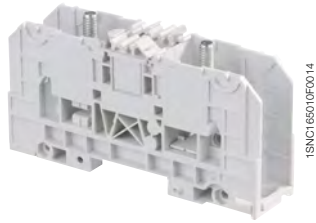

D35/27.FF

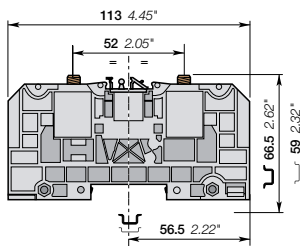

27 mm 1.062 in spacing

Description

- Rated cross section up to 300 mm² / 1000 Kcmil, IP20 protection cover,
- Holding foot on DIN 3 rail with two position for easy mounting, lug mounting in accordance with NF C 20-130 and DIN 46234, various marking options, rail or base mounting.

Ordering details

Description	Color	Type	Part Number	Pkg qty	Weight (1 pce) g
Feed-through 2 studs M6 without cover	Grey <input type="checkbox"/>	D35/27.FF	1SNA190001R2000	10	130.00

Main technical data

Connecting capacity		NF C	DIN	UL	CSA
Lugs	Rigid: Solid/Stranded	2.5-35 mm ²	2.5-50 mm ²	1 AWG	
	Flexible with insulated ferrules	2.5-35 mm ²	2.5-35 mm ²		
	Gauge	C4			
Screw clamp		IEC		UL	CSA
Screw clamp	Rigid: Solid/Stranded				
	Flexible without ferrule				
Screw clamp	Gauge				
		IEC		UL	CSA
Bar					
Rated current		125 A		125 A	
Rated cross section		35 mm ²		1 AWG	
Rated voltage		1000 V		600 V	
Impulse withstand voltage		8000 V			

Mounting instructions

Rail		TH 35-7.5, TH 35-15
Lugs		Wrench H10 mm
Tool		
Torque		3 - 6 N.m 26.1 - 52 lb.in
Jumper screw		Allen key 6 mm
Tool		0.236 in
Torque		6 - 12 N.m 52 - 104 lb.in
Screw clamp		
Tool		
Torque		
Wire stripping length		

The connecting capacity data for one Rigid: Solid/Stranded, or one Flexible conductor (when applicable) is a mandatory information required by IEC, UL and CSA standards (Copper conductors). All other data are provided as supplementary information only. For more details, please consult our CB, UL or CSA certificates and technical datasheet available on <http://www.TE.com>



Accessories

Description	Color	Type	Part Number	Pkg qty	Weight (1 pce) g
1 End stops 10 mm 0.394 in	Dark grey <input type="checkbox"/>	BAZH1	1SNK900102R0000	20	24.00
2 Jumper bars 2 poles		BJS27-2	1SNA205772R1300	5	34.00
		BJS27-3	1SNA205773R1400	5	52.00
3 Splitters For 6.35x0.8mm faston clips and screws		DRF6	1SNA205767R1600	10	4.00
4 Protecting covers IP20 rotating protecting cover	Grey <input type="checkbox"/>	CPUF35	1SNA190016R1600	2	8.30
5 Terminal block markers Blank card	White <input type="checkbox"/>	RC810	1SNA234000R0200	1	8.20

Complete list of accessories is indicated in the terminal block datasheet.

Some accessories such as jumper bars may modify the terminal block's ratings: complete information in the accessories catalogue pages.

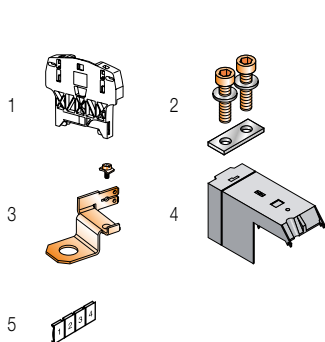

Technical data valid for copper conductors only.

D70/32.FF power terminal blocks

Feed-through - 32 mm 1.260 in spacing



D70/32.FF

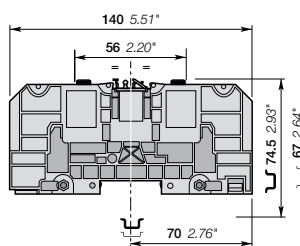

32 mm 1.260 in spacing

Description

- Rated cross section up to 300 mm² / 1000 Kcmil, IP20 protection cover,
- Holding foot on DIN 3 rail with two position for easy mounting, lug mounting in accordance with NF C 20-130 and DIN 46234, various marking options, rail or base mounting.

Ordering details

Description	Color	Type	Part Number	Pkg qty	Weight (1 pce) g
Feed-through 2 studs M8 without cover	Grey <input type="checkbox"/>	D70/32.FF	1SNA190002R2100	3	269.00

Main technical data

Connecting capacity	NF C	DIN	UL	CSA
Lugs				
Rigid: Solid/Stranded	6-95 mm ²	6-70 mm ²	000 AWG	
Flexible with insulated ferrules	6-70 mm ²	6-70 mm ²		
Gauge	C6			
Screw clamp				
Rigid: Solid/Stranded				
Flexible without ferrule				
Gauge				
Bar				
Rated current	192 A		170 A	
Rated cross section	70 mm ²		000 AWG	
Rated voltage	1000 V		600 V	
Impulse withstand voltage	8000 V			

Mounting instructions

Rail		TH 35-7.5, TH 35-15
Lugs		Wrench H13 mm
Tool		
Torque		6 - 12 N.m 52 - 104 lb.in
Jumper screw		Allen key 6 mm 0.236 in
Tool		
Torque		6 - 12 N.m 52 - 104 lb.in
Screw clamp		
Tool		
Torque		
Wire stripping length		

The connecting capacity data for one Rigid: Solid/Stranded, or one Flexible conductor (when applicable) is a mandatory information required by IEC, UL and CSA standards (Copper conductors). All other data are provided as supplementary information only. For more details, please consult our CB, UL or CSA certificates and technical datasheet available on <http://www.TE.com>

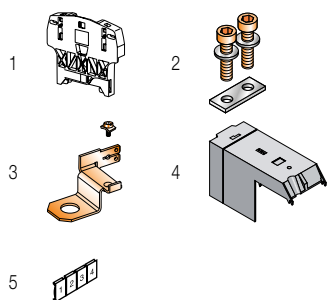

Accessories

Description	Color	Type	Part Number	Pkg qty	Weight (1 pce) g
1 End stops 10 mm 0.394 in	Dark grey <input checked="" type="checkbox"/>	BAZH1	1SNC900102R0000	20	24.00
2 Jumper bars 2 poles		BJS32-2	1SNA205774R1500	5	66.00
3 poles		BJS32-3	1SNA205775R1600	5	105.80
3 Splitters For 6.35x0.8mm faston clips and screws		DRF8	1SNA205768R2700	10	5.00
4 Protecting covers IP20 rotating protecting cover	Grey <input type="checkbox"/>	CPUF70	1SNA190017R1700	2	12.00
5 Terminal block markers Blank card	White <input type="checkbox"/>	RC810	1SNA234000R0200	1	8.20

Complete list of accessories is indicated in the terminal block datasheet. Some accessories such as jumper bars may modify the terminal block's ratings: complete information in the accessories catalogue pages.

Technical data valid for copper conductors only.

D120/42.FF power terminal blocks

Feed-through - 42 mm 1.653 in spacing



D120/42.FF

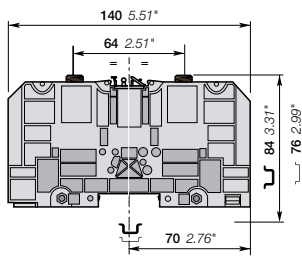

42 mm 1.653 in spacing

Description

- Rated cross section up to 300 mm² / 1000 Kcmil, IP20 protection cover,
- Holding foot on DIN 3 rail with two position for easy mounting, lug mounting in accordance with NF C 20-130 and DIN 46234, various marking options, rail or base mounting.

Ordering details

Description	Color	Type	Part Number	Pkg qty	Weight (1 pce) g
Feed-through 2 studs M10 without cover	Grey <input type="checkbox"/>	D120/42.FF	1SNA190003R2200	1	423.00

Main technical data

Connecting capacity		NF C	DIN	UL	CSA
Lugs	Rigid: Solid/Stranded	6-150 mm ²	6-120 mm ²	300 Kcmil	
	Flexible with insulated ferrules	6-120 mm ²			
	Gauge	C8			
Screw clamp		IEC	UL	CSA	
Bar	Rigid: Solid/Stranded				
	Flexible without ferrule				
	Gauge				
Rated current		269 A		269 A	
Rated cross section		120 mm ²		300 Kcmil	
Rated voltage		1000 V		600 V	
Impulse withstand voltage		8000 V			

Mounting instructions

Rail		TH 35-7.5, TH 35-15
Lugs		Wrench H17 mm
Tool		
Torque		10 - 20 N.m 87 - 174 lb.in
Jumper screw		Allen key 6 mm 0.236 in
Tool		
Torque		6 - 12 N.m 52 - 104 lb.in
Screw clamp		
Tool		
Torque		
Wire stripping length		

The connecting capacity data for one Rigid: Solid/Stranded, or one Flexible conductor (when applicable) is a mandatory information required by IEC, UL and CSA standards (Copper conductors). All other data are provided as supplementary information only. For more details, please consult our CB, UL or CSA certificates and technical datasheet available on <http://www.TE.com>



Accessories

Description	Color	Type	Part Number	Pkg qty	Weight (1 pce) g
1 End stops 10 mm 0.394 in	Dark grey <input type="checkbox"/>	BAZH1	1SNK900102R0000	20	24.00
2 Jumper bars 2 poles		BJS42-2	1SNA205776R1700	5	93.00
		BJS42-3	1SNA205777R1000	5	153.00
3 Splitters For 6.35x0.8mm faston clips and screws		DRF10	1SNA205769R2000	10	7.00
4 Protecting covers IP20 rotating protecting cover	Grey <input type="checkbox"/>	CPUF120	1SNA190018R2000	2	24.00
5 Terminal block markers Blank card	White <input type="checkbox"/>	RC810	1SNA234000R0200	1	8.20

Complete list of accessories is indicated in the terminal block datasheet.

Some accessories such as jumper bars may modify the terminal block's ratings: complete information in the accessories catalogue pages.

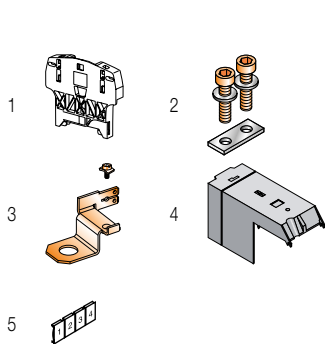

Technical data valid for copper conductors only.

D185/55.FF power terminal blocks

Feed-through - 55 mm 2.165 in spacing



D185/55.FF

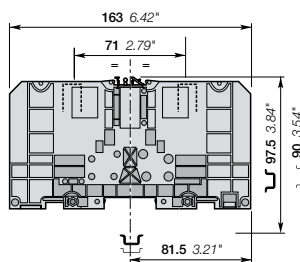

55 mm 2.165 in spacing

Description

- Rated cross section up to 300 mm² / 1000 Kcmil, IP20 protection cover,
- Holding foot on DIN 3 rail with two position for easy mounting, lug mounting in accordance with NF C 20-130 and DIN 46234, various marking options, rail or base mounting.

Ordering details

Description	Color	Type	Part Number	Pkg qty	Weight (1 pce) g
Feed-through 2 studs M12 without cover	Grey <input type="checkbox"/>	D185/55.FF	1SNA190004R2300	1	615.00

Main technical data

Connecting capacity	NF C	DIN	UL	CSA
Lugs	Rigid: Solid/Stranded Flexible with insulated ferrules Gauge	25-240 mm ² 6-185 mm ² C11	6-185 mm ² 500 Kcmil	
Screw clamp	Rigid: Solid/Stranded Flexible without ferrule Gauge		IEC UL CSA	
Bar			IEC UL CSA	
Rated current		353 A	353 A	
Rated cross section		185 mm ²	500 Kcmil	
Rated voltage		1000 V	600 V	
Impulse withstand voltage		8000 V		

Mounting instructions

Rail		TH 35-7.5, TH 35-15
Lugs Tool		Wrench H24 mm
Torque		14 - 30 N.m 123.9 - 265.5 lb.in
Jumper screw Tool		Allen key 6 mm 0.236 in
Torque		6 - 12 N.m 52 - 104 lb.in
Screw clamp Tool		
Torque		
Wire stripping length		

The connecting capacity data for one Rigid: Solid/Stranded, or one Flexible conductor (when applicable) is a mandatory information required by IEC, UL and CSA standards (Copper conductors). All other data are provided as supplementary information only. For more details, please consult our CB, UL or CSA certificates and technical datasheet available on <http://www.TE.com>

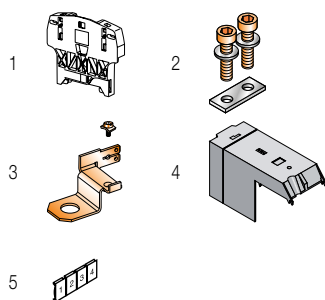

Accessories

Description	Color	Type	Part Number	Pkg qty	Weight (1 pce) g
1 End stops 10 mm 0.394 in	Dark grey <input checked="" type="checkbox"/>	BAZH1	1SNK900102R0000	20	24.00
2 Jumper bars 2 poles		BJS551-2	1SNA205778R2100	5	158.00
3 poles		BJS551-3	1SNA205779R2200	5	266.00
3 Splitters For 6.35x0.8mm faston clips and screws		DRF12	1SNA205770R2500	10	8.00
4 Protecting covers IP20 rotating protecting cover	Grey <input type="checkbox"/>	CPUF185	1SNA190019R2100	2	40.00
5 Terminal block markers Blank card	White <input type="checkbox"/>	RC810	1SNA234000R0200	1	8.20

Complete list of accessories is indicated in the terminal block datasheet. Some accessories such as jumper bars may modify the terminal block's ratings: complete information in the accessories catalogue pages.

Technical data valid for copper conductors only.

D300/55.FF power terminal blocks

Feed-through - 55 mm 2.165 in spacing



D300/55.FF

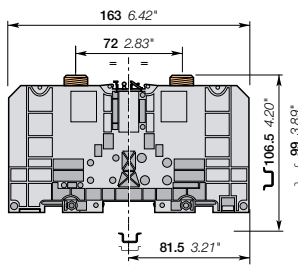

55 mm 2.165 in spacing

Description

- Rated cross section up to 300 mm² / 1000 Kcmil, IP20 protection cover,
- Holding foot on DIN 3 rail with two position for easy mounting, lug mounting in accordance with NF C 20-130 and DIN 46234, various marking options, rail or base mounting.

Ordering details

Description	Color	Type	Part Number	Pkg qty	Weight (1 pce) g
Feed-through 2 studs M16 without cover	Grey <input type="checkbox"/>	D300/55.FF	1SNA190005R2400	1	775.00

Main technical data

Connecting capacity		NF C	DIN	UL	CSA
Lugs	Rigid: Solid/Stranded	25-300 mm ²	6-300 mm ²	1000 Kcmil	
	Flexible with insulated ferrule	6-300 mm ²			
Gauge					
Screw clamp		IEC	UL	CSA	
Screw clamp	Rigid: Solid/Stranded				
	Flexible without ferrule				
Gauge					
Bar		IEC	UL	CSA	
Rated current		520 A	460 A		
Rated cross section		300 mm ²	1000 Kcmil		
Rated voltage		1000 V	600 V		
Impulse withstand voltage		8000 V			

Mounting instructions

Rail		TH 35-7.5, TH 35-15
Lugs		Wrench H24 mm
Tool		
Torque		25 - 50 N.m 217 - 435 lb.in
Jumper screw		Allen key 6 mm 0.236 in
Tool		
Torque		6 - 12 N.m 52 - 104 lb.in
Screw clamp		
Tool		
Torque		
Wire stripping length		

The connecting capacity data for one Rigid: Solid/Stranded, or one Flexible conductor (when applicable) is a mandatory information required by IEC, UL and CSA standards (Copper conductors). All other data are provided as supplementary information only. For more details, please consult our CB, UL or CSA certificates and technical datasheet available on <http://www.TE.com>



6

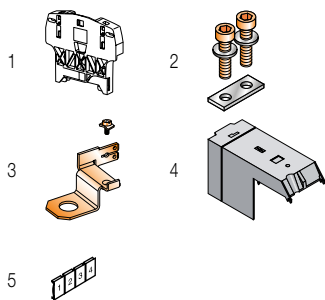

Accessories

Description	Color	Type	Part Number	Pkg qty	Weight (1 pce) g
1 End stops 10 mm 0.394 in	Dark grey <input type="checkbox"/>	BAZH1	1SNK900102R0000	20	24.00
2 Jumper bars 2 poles		BJS551-2	1SNA205778R2100	5	158.00
		BJS551-3	1SNA205779R2200	5	266.00
3 Splitters For 6.35x0.8mm faston clips and screws		DRF16	1SNA205771R1200	10	7.00
4 Protecting covers IP20 rotating protecting cover	Grey <input type="checkbox"/>	CPUF185	1SNA190019R2100	2	40.00
5 Terminal block markers Blank card	White <input type="checkbox"/>	RC810	1SNA234000R0200	1	8.20

Complete list of accessories is indicated in the terminal block datasheet.

Some accessories such as jumper bars may modify the terminal block's ratings: complete information in the accessories catalogue pages.

Technical data valid for copper conductors only.

RGW2.5 Ring lug terminal blocks

Feed-through - 9 mm 0.354 in spacing



RGW2.5

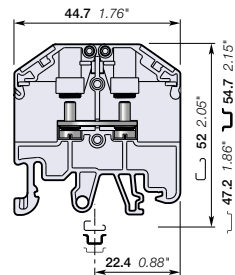

9 mm 0.354 in spacing

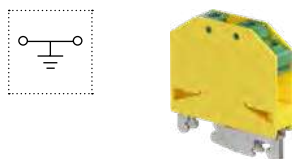
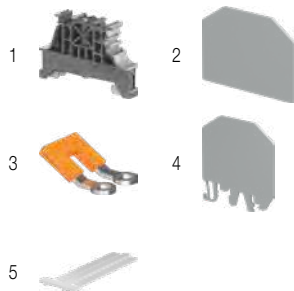

Description

- Stud terminal block for ring lug connection,
- Integrated captive nuts in protective wings provide easy and secured connection,
- Universal mounting on symmetrical and asymmetrical rails.

Ordering details

Description	Color	Type	Part Numbers	Pkg qty	Weight (1 pce) g
Feed-through With 2 studs M3 and captive nuts in wings	Grey <input type="checkbox"/>	RGW2.5-V0	1SNA510003R0000	45	11.78

Main technical data

Lugs	Rigid: Solid/Stranded Flexible with insulated ferrule Gauge	IEC	UL	CSA
		0.1 ... 2.5 mm ²	26 ... 14 AWG	26 ... 14 AWG
Rated current		24 A	15 A	20 A
Maximum current			20 A	
Rated cross section		2.5 mm ²	14 AWG	14 AWG
Rated short-time withstand current (1s)		300 A		
Rated voltage		800 V	600 V	600 V
Impulse withstand voltage		8000 V		
Protection		IP10	NEMA 1	

Mounting instructions

Rail		G32, TH 35-7.5, TH 35-15
Nuts		Flat screwdriver Ø 4 mm Ø 0.157 in
Tool		
Torque		0.6 ... 0.8 N.m 5.3 ... 7.1 lb.in
Max width of lug		7 mm 0.28 in

The connecting capacity data for one Rigid: Solid/Stranded, or one Flexible conductor (when applicable) is a mandatory information required by IEC, UL and CSA standards (Copper conductors). All other data are provided as supplementary information only. For more details, please consult our CB, UL or CSA certificates and technical datasheet available on <http://www.TE.com>

--	--	--	--

Accessories

Description	Color	Type	Part Numbers	Pkg qty	Weight (1 pce) g
1 End stops 10 mm 0.394 in	Dark grey <input type="checkbox"/>	BAM4	1SNK900001R0000	50	14.00
2 End sections 1.2 mm 0.047 in	Grey <input type="checkbox"/>	E-RGW2.5	1SNA519003R0000	25	1.89
3 Lateral jumper bars 2 poles 24 A (IEC) 3 poles 24 A (IEC) 4 poles 24 A (IEC) 10 poles 24 A (IEC)	Orange <input type="checkbox"/>	PC-RG2.5-2	1SNA519103R0200	25	3.02
		PC-RG2.5-3	1SNA519103R0300	20	4.69
		PC-RG2.5-4	1SNA519103R0400	15	6.36
		PC-RG2.5-10	1SNA519103R1000	5	16.39
4 Circuit separators 1.5 mm 0.059 in	Grey <input type="checkbox"/>	CS-RGW-S	1SNA519200R0000	25	4.59
5 Terminal block markers	White <input type="checkbox"/>	M-W610PC	1SNA235511R0600	360	8.03
		MG-CPM-01 41090	1SNB041090R0510	1960	0.351

Complete list of accessories is indicated in the terminal block datasheet including end stops.

Some accessories such as jumper bars may modify the terminal block's ratings: Complete information available in the accessories section of the catalog.

Ground Ring lug terminal blocks

Description	Color	Type	Part Numbers	Pkg qty	Weight (1 pce) g
Ground With 2 studs M3 and captive nuts in wings	Green-yellow <input type="checkbox"/>	RGW2.5-PE-V0	1SNA511003R0500	45	28.56

Technical data valid for copper conductors only.

RGW6 Ring lug terminal blocks

Feed-through - 11 mm 0.433 in spacing

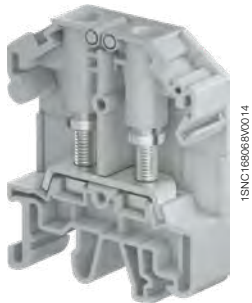

RGW6

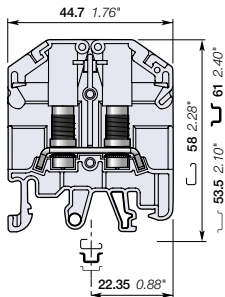

11 mm 0.433 in spacing

Description

- Stud terminal block for ring lug connection,
- Integrated captive nuts in protective wings provide easy and secured connection,
- Universal mounting on symmetrical and asymmetrical rails.

Ordering details

Description	Color	Type	Part Numbers	Pkg qty	Weight (1 pce) g
Feed-through With 2 studs M4 and captive nuts in wings	Grey <input type="checkbox"/>	RGW6-V0	1SNA510024R0000	40	19.76

Main technical data

Lugs	Rigid: Solid/Stranded Flexible with insulated ferrule Gauge	IEC	UL	CSA
		0.1 ... 6 mm²	22 ... 10 AWG	22 ... 10 AWG
Rated current		41 A	30 A	30 A
Maximum current			30 A	
Rated cross section	6 mm²		10 AWG	10 AWG
Rated short-time withstand current (1s)	720 A			
Rated voltage	800 V	600 V	600 V	
Impulse withstand voltage	8000 V			
Protection	IP10	NEMA 1		

Mounting instructions

Rail		G32, TH 35-7.5, TH 35-15
Nuts		Flat screwdriver Ø 5.5 mm Ø 0.217 in
Tool		
Torque		0.8 ... 1.2 N.m 7.1 ... 10.6 lb.in
Max width of lug		9.4 mm 0.37 in

The connecting capacity data for one Rigid: Solid/Stranded, or one Flexible conductor (when applicable) is a mandatory information required by IEC, UL and CSA standards (Copper conductors). All other data are provided as supplementary information only. For more details, please consult our CB, UL or CSA certificates and technical datasheet available on <http://www.TE.com>

--	--	--	--

Accessories

Description	Color	Type	Part Numbers	Pkg qty	Weight (1 pce) g	
1 End stops 10 mm 0.394 in	Dark grey <input type="checkbox"/>	BAM4	1SNK900001R0000	50	14.00	
2 End sections 1.4 mm 0.055 in	Grey <input type="checkbox"/>	E-RGW6	1SNA519004R0000	50	2.65	
3 Lateral jumper bars	Orange <input type="checkbox"/>	2 poles 41 A (IEC)	PC-RG6-2	1SNA519104R0200	25	3.44
		3 poles 41 A (IEC)	PC-RG6-3	1SNA519104R0300	20	5.40
		4 poles 41 A (IEC)	PC-RG6-4	1SNA519104R0400	15	7.33
		7 poles 41 A (IEC)	PC-RG6-7	1SNA519104R0700	5	13.24
		10 poles 41 A (IEC)	PC-RG6-10	1SNA519104R1000	5	19.05
4 Circuit separators 1.5 mm 0.059 in	Grey <input type="checkbox"/>	CS-RGW-S	1SNA519200R0000	25	4.59	
5 Terminal block markers	White <input type="checkbox"/>	M-W810PC	1SNA235510R0800	260	0.27	
		MG-CPM-01 41096	1SNB041096R0810	1120	0.400	

Complete list of accessories is indicated in the terminal block datasheet including end stops.

Some accessories such as jumper bars may modify the terminal block's ratings: Complete information available in the accessories section of the catalog.

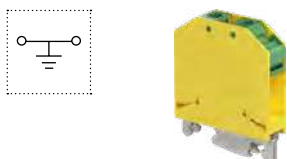

Ground Ring lug terminal blocks

Description	Color	Type	Part Numbers	Pkg qty	Weight (1 pce) g
Ground With 2 studs M4 and captive nuts in wings	Green-yellow <input type="checkbox"/>	RGW6-PE-V0	1SNA511024R0500	40	31.76

Technical data valid for copper conductors only.

RGW25-M5 Ring lug terminal blocks

Feed-through - 18 mm 0.709 in spacing

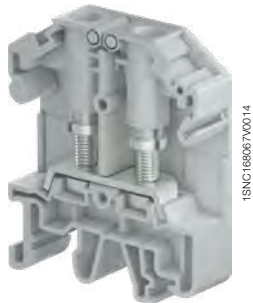

RGW25-M5

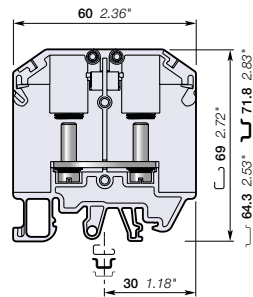

18 mm 0.709 in spacing

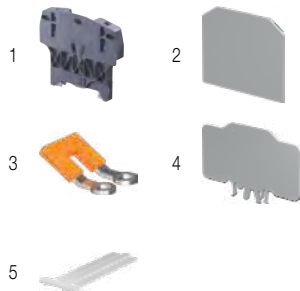

Description

- Stud terminal block for ring lug connection,
- Integrated captive nuts in protective wings provide easy and secured connection,
- Universal mounting on symmetrical and asymmetrical rails.

Ordering details

Description	Color	Type	Part Numbers	Pkg qty	Weight (1 pce) g
Feed-through With 2 studs M5 and captive nuts in wings	Grey <input type="checkbox"/>	RGW25-M5-V0	1SNA510005R0000	10	49.10

Main technical data

	IEC	UL	CSA
Lugs	Rigid: Solid/Stranded Flexible with insulated ferrule Gauge	0.1 ... 25 mm ² 0.1 ... 25 mm ²	26 ... 4 AWG 26 ... 4 AWG
Rated current	101 A	85 A	100 A
Maximum current		115 A	
Rated cross section	25 mm ²	4 AWG	4 AWG
Rated short-time withstand current (1s)	3000 A		
Rated voltage	800 V	600 V	600 V
Impulse withstand voltage	8000 V		
Protection	IP10	NEMA 1	

Mounting instructions

Rail		G32, TH 35-7.5, TH 35-15
Nuts		Flat screwdriver Ø 5.5 mm Ø 0.217 in
Tool		
Torque		3 ... 3.5 N.m 26.5 ... 31 lb.in
Max width of lug		16.2 mm 0.64 in

The connecting capacity data for one Rigid: Solid/Stranded, or one Flexible conductor (when applicable) is a mandatory information required by IEC, UL and CSA standards (Copper conductors). All other data are provided as supplementary information only. For more details, please consult our CB, UL or CSA certificates and technical datasheet available on <http://www.TE.com>

--	--	--	--	--	--	--	--	--	--

Accessories

Description	Color	Type	Part Numbers	Pkg qty	Weight (1 pce) g
1 End stops 10 mm 0.394 in	Dark grey <input type="checkbox"/>	BAZH1	1SNK900102R0000	20	24.00
2 End sections 1.4 mm 0.055 in	Grey <input type="checkbox"/>	E-RGW25	1SNA519005R0000	25	0.146
3 Lateral jumper bars 2 poles 101 A (IEC)	Orange <input type="checkbox"/>	PC-RG25-2	1SNA519106R0200	25	8.81
4 Circuit separators 2 mm 0.079 in	Grey <input type="checkbox"/>	CS-RGW-L	1SNA519201R0000	25	13.72
5 Terminal block markers	White <input type="checkbox"/>	M-W1010PC	1SNA235512R1000	200	0.10
		MG-CPM-01 41096	1SNB041096R0810	1120	0.400

Complete list of accessories is indicated in the terminal block datasheet including end stops.

Some accessories such as jumper bars may modify the terminal block's ratings: Complete information available in the accessories section of the catalog.

Technical data valid for copper conductors only.

RGW25-M6 Ring lug terminal blocks

Feed-through - 18 mm 0.709 in spacing

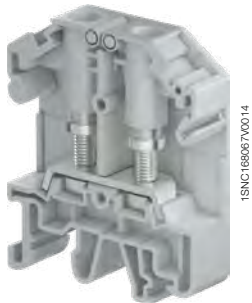

RGW25-M6

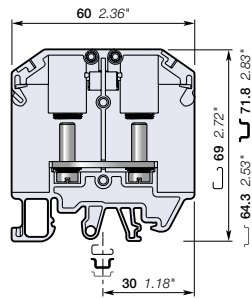

18 mm 0.709 in spacing

Description

- Stud terminal block for ring lug connection,
- Integrated captive nuts in protective wings provide easy and secured connection,
- Universal mounting on symmetrical and asymmetrical rails.

Ordering details

Description	Color	Type	Part Numbers	Pkg qty	Weight (1 pce) g
Feed-through With 2 studs M6 and captive nuts in wings	Grey <input type="checkbox"/>	RGW25-M6-V0	1SNA510006R0000	10	48.44

Main technical data

Lugs	Rigid: Solid/Stranded Flexible with insulated ferrule Gauge	IEC	UL	CSA
		0.1 ... 25 mm ²	26 ... 4 AWG	26 ... 4 AWG
Rated current		101 A	85 A	100 A
Maximum current			115 A	
Rated cross section	25 mm ²		4 AWG	4 AWG
Rated short-time withstand current (1s)	3000 A			
Rated voltage	800 V	600 V	600 V	
Impulse withstand voltage	8000 V			
Protection	IP10	NEMA 1		

Mounting instructions

Rail		G32, TH 35-7.5, TH 35-15
Nuts		Flat screwdriver Ø 5.5 mm Ø 0.217 in
Tool		
Torque		3.2 ... 3.5 N.m 28.3 ... 32.7 lb.in
Max width of lug		16.2 mm 0.64 in

The connecting capacity data for one Rigid: Solid/Stranded, or one Flexible conductor (when applicable) is a mandatory information required by IEC, UL and CSA standards (Copper conductors). All other data are provided as supplementary information only. For more details, please consult our CB, UL or CSA certificates and technical datasheet available on <http://www.TE.com>

CE	RoHS	UL	CSA

Accessories

Description	Color	Type	Part Numbers	Pkg qty	Weight (1 pce) g
1 End stops 10 mm 0.394 in	Dark grey <input type="checkbox"/>	BAZH1	1SNK900102R0000	20	24.00
2 End sections 1.4 mm 0.055 in	Grey <input type="checkbox"/>	E-RGW25	1SNA519005R0000	25	0.146
3 Lateral jumper bars 2 poles 101 A (IEC)	Orange <input type="checkbox"/>	PC-RGW25-2	1SNA519106R0200	25	8.81
4 Circuit separators 2 mm 0.079 in	Grey <input type="checkbox"/>	CS-RGW-L	1SNA519201R0000	25	13.72
5 Terminal block markers	White <input type="checkbox"/>	M-W1010PC	1SNA235512R1000	200	0.10
		MG-CPM-01 41096	1SNB041096R0810	1120	0.400

Complete list of accessories is indicated in the terminal block datasheet including end stops.

Some accessories such as jumper bars may modify the terminal block's ratings: Complete information available in the accessories section of the catalog.

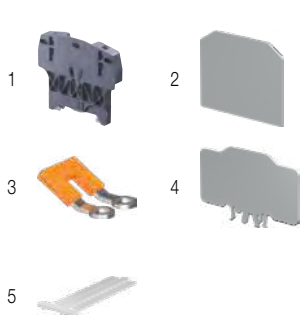

Technical data valid for copper conductors only.



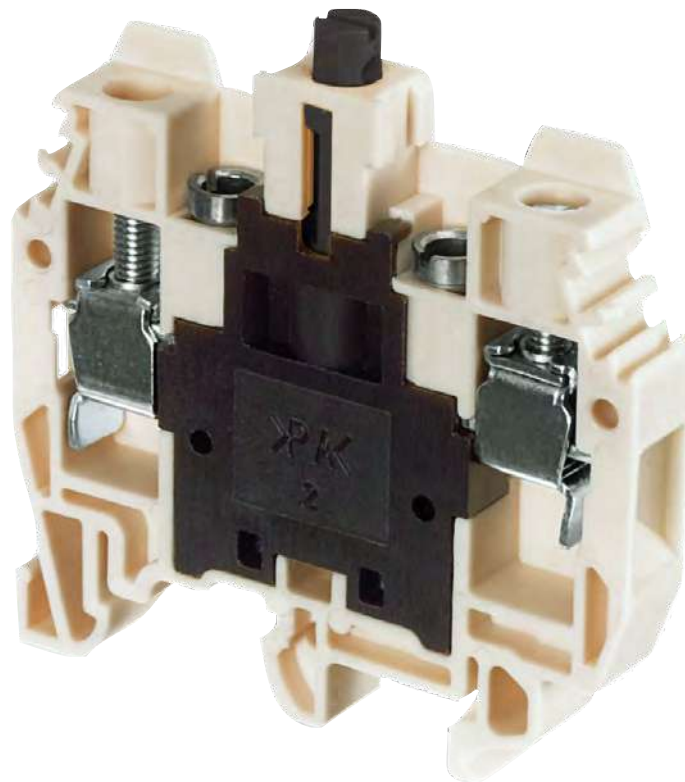

7

Railway applications, terminal blocks

Screw clamp technology complying with NF F 55251

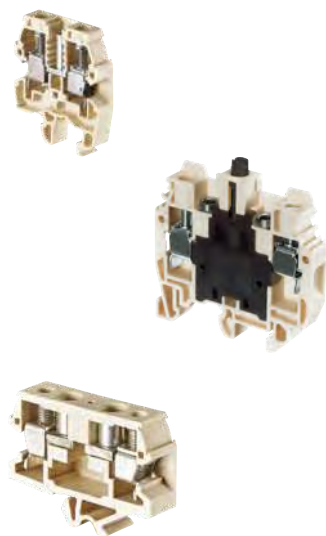

Technologies presentation	208
Overview	210

Feed-through

2.5 mm ²	E4/6	211
6 mm ²	E6/8	212
10 mm ²	E10/16	213

Disconnect with push-turn knob

6 mm ²	M6/8.STP	1/4 turn push-turn knob	214
	ES8-CG	1/4 turn push-turn knob - contact protected by dust cover	215

Disconnect with plug

10 mm ²	E10/16.S	216
--------------------	-----------------	-----

Railway applications, terminal blocks

Screw clamp technology complying with NF F 55251 and CT448



The proven reliability and performance for railway infrastructure

The screw clamp technology complying with NF F 55251 and CT448 minimizes maintenance & trouble shooting operations thanks to the anti-release system. The screw is locked in total safety.

The high density capacity screw clamp connection can fit up to two conductors per clamp which offers extended possibilities in electrical cabinets.



Reliable in harsh conditions

Excellent withstand in corrosive atmosphere

- Self-cleaning push-turn knob
- Stainless steel screw
- Nickered copper alloy compression clamp
- Dust protection covering.



Continuous operations

Maintenance and trouble shooting operations are minimized

- Thanks to our anti-release system
- Screw is locked in total safety.

Features

Focus on ES8-CG

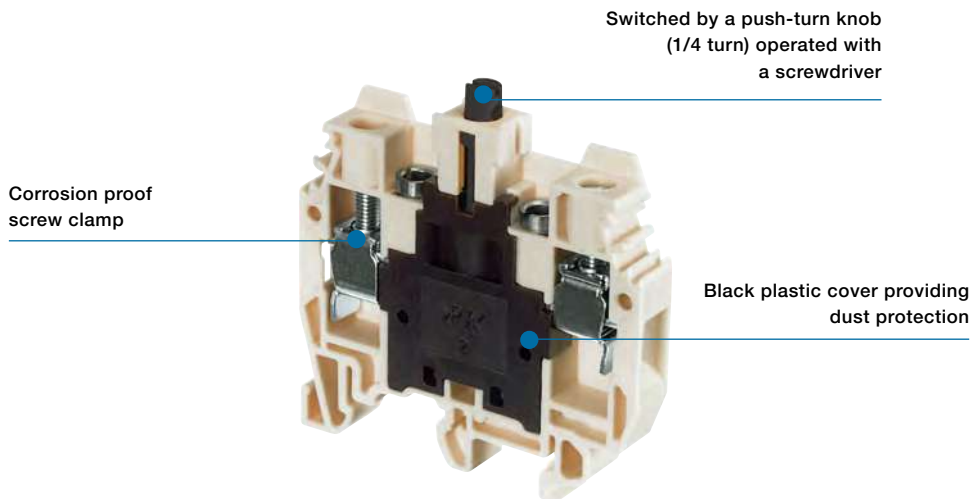
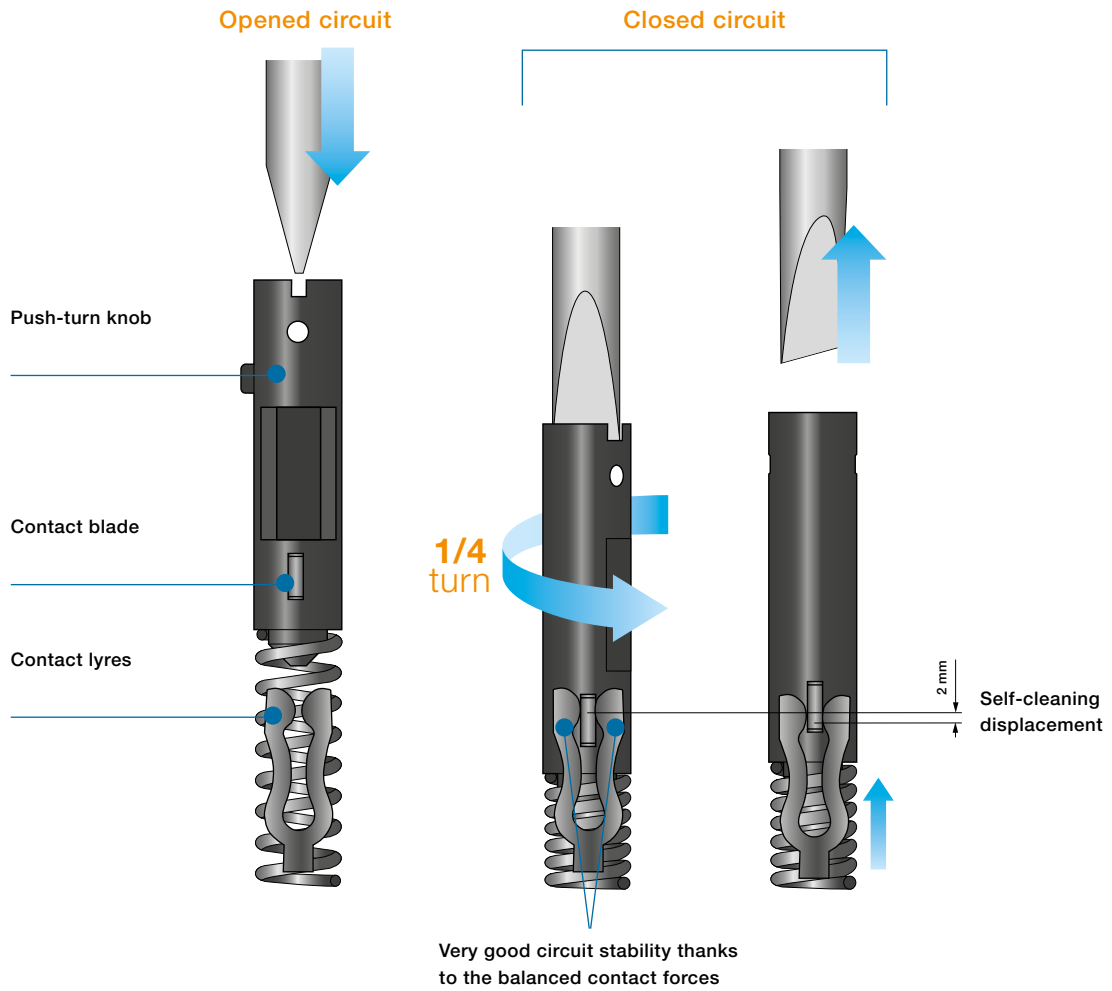

Railway applications, terminal blocks

Screw clamp and pluggable technologies



Feed-through

Section			
2.5 mm ²	E4/6	E6/8	E10/16
6 mm ²			
10 mm ²			



Disconnect with plug

Disconnect with push-turn knob

Section			
6 mm ²	E10/16.S	M6/8.STP	ES8-CG
10 mm ²			

Clamp -
 Channels for jumpering or testing -
 Test socket -
 Blown-fuse indicator

E4/6 railway terminal blocks

Feed-through - 6 mm 0.236 in spacing



E4/6

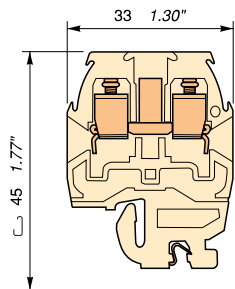

6 mm 0.236 in spacing

Description

- Ease your test operations with the built-in test socket - NF F 55-251 designation: ER 6,
- Sy SNCF 7 963 1088.

Ordering details

Description	Color	Type	Part Numbers	Pkg qty	Weight (1 pce) g
Feed-through With test socket DIA 2 mm 0.079 in	Beige	E4/6	1SNA190468R0000	50	8.00

Main technical data

Connecting capacity		NF C	DIN	NF F 55-251	Mounting instructions	
1 conductor per clamp	Rigid: Solid/Stranded	0.5 ... 4 mm ²			Rail	G32
	Flexible without ferrule	0.5 ... 2.5 mm ²			Wire stripping length	9.5 mm 0.374 in
					Tool	Flat screwdriver Ø 4 mm Ø 0.157 in
Rated voltage	V AC	500 V	750 V	500 V	Torque	0.5 - 0.8 N.m 4.43 - 7.08 lb.in
	V DC	500 V	900 V	500 V		
Rated current		30 A	26 A	30 A		
Rated cross section		2.5 mm ²	2.5 mm ²	2.5 mm ²		

--	--	--	--	--	--	--	--	--	--

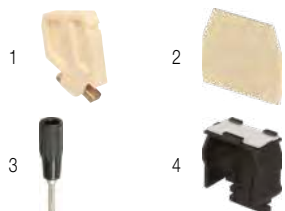

Accessories

Description	Color	Type	Part Numbers	Pkg qty	Weight (1 pce) g	
1 End stops 10 mm 0.394 in	Beige	BAR	1SNA164519R2400	50	11.00	
2 End sections 1 mm 0.039 in	Beige	FEE6-1	1SNA193080R1200	25	1.30	
3 Test plugs DIA 2 mm 0.079 in	Black	FC2	1SNA007865R2600	100	2.00	
4 Terminal block markers	Label holder	Black	PE	1SNA103007R2300	25	13.00
	Blank card	White	RC610	1SNA233000R0100	10	7.50

E6/8 railway terminal blocks

Feed-through - 8 mm 0.315 in spacing



6 mm²



1SNC167148F0014

E6/8

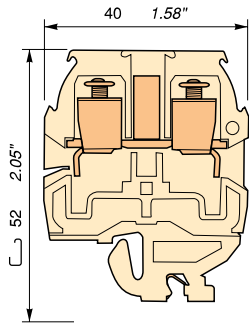

8 mm 0.315 in spacing

Description

- Ease you test operations with the built-in test socket - NF F 55-251 designation: ER 8,
- Sy SNCF 7 963 1114.

Ordering details

Description	Color	Type	Part Numbers	Pkg qty	Weight (1 pce)
Feed-through With test socket DIA 4 mm 0.157 in	Beige <input type="checkbox"/>	E6/8	1SNA190607R0400	50	15.00

Main technical data

Connecting capacity		NF C	DIN	NF F 55-251	Mounting instructions	
1 conductor per clamp	Rigid: Solid/Stranded	0.5 ... 10 mm ²			Rail	G32
	Flexible without ferrule	0.5 ... 6 mm ²			Wire stripping length	13 mm 0.512 in
					Tool	Flat screwdriver Ø 5 mm Ø 0.197 in
Rated voltage	V AC	500 V	750 V	500 V	Torque	0.8 - 1 N.m 7.08 - 8.85 lb.in
	V DC	500 V	900 V	500 V		
Rated current		51 A	46 A	51 A		
Rated cross section		6 mm ²	6 mm ²	6 mm ²		

--	--	--	--	--	--	--	--	--	--

Accessories

Description	Color	Type	Part Numbers	Pkg qty	Weight (1 pce)
1 End stops 10 mm 0.394 in	Beige <input type="checkbox"/>	BAR	1SNA164519R2400	50	11.00
2 End sections 1 mm 0.039 in	Beige <input type="checkbox"/>	FEE8-2	1SNA193085R0300	25	2.00
3 Lateral jumper bars 2 poles 50 A (IEC)	Black <input type="checkbox"/>	PC8-2	1SNA116538R1700	10	3.00
		PC8-10	1SNA163313R2400	10	14.00
4 Test plugs DIA 4 mm 0.157 in	White <input type="checkbox"/>	FC4	1SNA167860R0100	10	10.00
5 Terminal block markers	Black <input type="checkbox"/>	PE	1SNA103007R2300	25	13.00
	White <input type="checkbox"/>	RC810	1SNA234000R0200	10	8.20



E10/16 railway terminal blocks

Feed-through - 16 mm 0.63 in spacing



E10/16

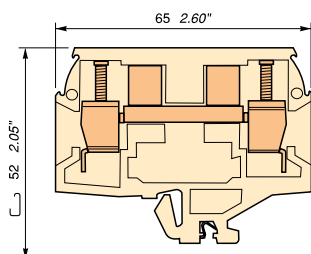

16 mm 0.63 in spacing

Description

- Ease your test operations with the built-in test socket - NF F 55-251 designation: ER 16,
- Sy SNCF 7 963 1110.

Ordering details

Description	Color	Type	Part Numbers	Pkg qty	Weight (1 pce) g
Feed-through With test socket DIA 4 mm 0.157 in	Beige	E10/16	1SNA191302R2700	25	47.00

Main technical data

Connecting capacity		NF C	DIN	NF F 55-251	Mounting instructions	
1 conductor per clamp	Rigid: Solid/Stranded	0.5 ... 16 mm ²			Rail	G32
	Flexible without ferrule	0.5 ... 10 mm ²			Wire stripping length	14 mm 0.551 in
					Tool	Flat screwdriver Ø 5.5 mm Ø 0.217 in
Rated voltage	V AC	750 V	750 V	500 V	Torque	2.5 - 3 N.m 22.1 - 26.6 lb.in
	V DC	500 V	900 V	500 V		
Rated current		71 A	63 A	71 A		
Rated cross section		10 mm ²	10 mm ²	10 mm ²		

--	--	--	--	--	--	--	--	--	--



Accessories

Description	Color	Type	Part Numbers	Pkg qty	Weight (1 pce) g	
1 End stops 10 mm 0.394 in	Beige	BAR	1SNA164519R2400	50	11.00	
2 End sections 1.5 mm 0.059 in	Beige	FEE10-16	1SNA193449R2400	10		
3 Lateral jumper bars 2 poles		PC	1SNA168497R2300	10	7.00	
4 Test plugs DIA 4 mm 0.157 in	White	FC4	1SNA167860R0100	10	10.00	
5 Terminal block markers	Label holder	Black	PE	1SNA103007R2300	25	13.00
	Blank card	White	RC1010	1SNA238000R1600	10	1.30

M6/8.STP railway terminal blocks

Disconnect with push-turn knob - 8 mm 0.315 in spacing

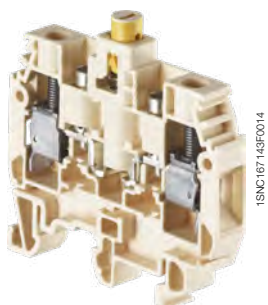

M6/8.STP

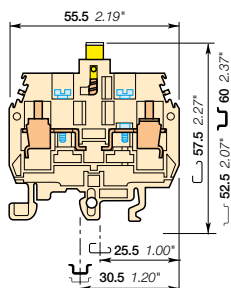

8 mm 0.315 in spacing

Description

- Ease your disconnect operations with the disconnect 1/4 turn push-turn knob,
- Possibility to seal in the open position,
- Ease your test operations with the built-in test socket,
- NF F 55-251 designation: ES 8,
- Sy SNCF 7 963 1156.

Ordering details

Description	Color	Type	Part Numbers	Pkg qty	Weight (1 pce) g
Disconnect With 2 tests sockets DIA 4 mm 0.157 in	Beige	M6/8.STP	1SNA195212R1000	25	21.00

Main technical data

Connecting capacity	NF C	DIN	NF F 55-251
1 conductor per clamp	Rigid: Solid/Stranded Flexible without ferrule	0.5 ... 10 mm ² 0.5 ... 6 mm ²	
Rated voltage	V AC V DC	500 V 500 V	500 V 500 V
Rated current		17 A 15 A	12 A
Rated cross section		6 mm ² 6 mm ²	6 mm ²

Mounting instructions

Rail		G32, TH 35-7.5, TH 35-15
Wire stripping length		11 mm 0.433 in
Tool		Flat screwdriver Ø 4 mm Ø 0.157 in
Torque		0.8 - 1 N.m 7.08 - 8.85 lb.in

--	--	--	--	--	--	--	--	--	--

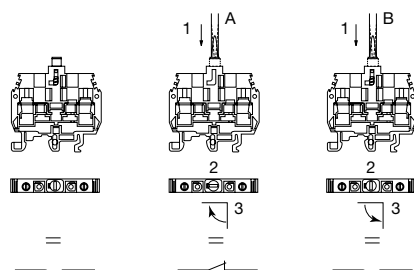

- A: Closing operation
B: Opening operation
1: Push
2: Turn
3: stop

Accessories

Description	Color	Type	Part Numbers	Pkg qty	Weight (1 pce) g
1 End stops 10 mm 0.394 in	Beige	BAM2	1SNA296351R0000	50	12.00
2 End sections 2.8 mm 0.110 in	Beige	FEMT1	1SNA193137R0300	50	2.00
3 Lateral jumper bars 1 poles 24 A (IEC)	Grey	AD2.5	1SNA114205R2000	50	1.60
3 Lateral jumper bars 2 poles 50 A (IEC)	Black	PC8-2	1SNA116538R1700	10	3.00
3 Lateral jumper bars 10 poles 50 A (IEC)		PC8-10	1SNA163313R2400	10	14.00
4 Test plugs DIA 4 mm 0.157 in	White	FC4	1SNA167860R0100	10	10.00
5 Short circuit plugs With test socket DIA 4 mm 0.157 in	Beige	BNSTP1	1SNA196792R1700	20	14.00
6 Terminal block markers Blank card	White	RC810	1SNA234000R0200	10	8.20



ES8-CG railway terminal blocks

Disconnect with push-turn knob - 8 mm 0.315 in spacing

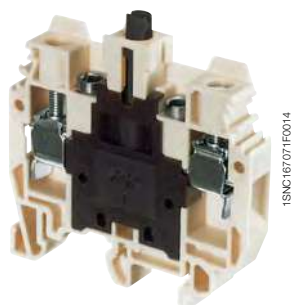

ES8-CG

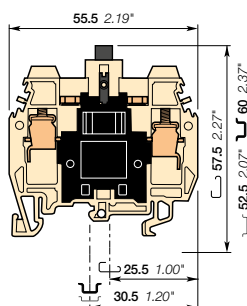

8 mm 0.315 in spacing

Description

- Particularly recommended for corrosive atmosphere: Self-cleaning displacement system and dust protection with plastic cover,
- Ease and safe your disconnect operations with the disconnect 1/4 turn push-turn knob,
- Possibility to seal in the open position,
- Ease your test operations with the built-in test socket.

Ordering details

Description	Color	Type	Part Numbers	Pkg qty	Weight (1 pce) g
Disconnect With 2 tests sockets DIA 4 mm 0.157 in	Beige	ES8-CG	1SNA400015R2000	25	21.00
	Green	ES8-CG	1SNA400014R2700	25	21.00

Main technical data

Connecting capacity		According to CT 448 of the IG PS 52		Mounting instructions	
1 conductor per clamp	Rigid: Solid/Stranded	0.5 ... 10 mm ²		Rail	G32, TH 35-7.5, TH 35-15
	Flexible without ferrule	0.5 ... 6 mm ²		Wire stripping length	11 mm 0.433 in
				Tool	Flat screwdriver Ø 4 mm Ø 0.157 in
Rated voltage	V AC	500 V		Torque	0.8 - 1 N.m 7.08 - 8.85 lb.in
	V DC	500 V			
Rated current		2 A			
Rated cross section		6 mm ²			

CE	RoHS	EAC								
CE	RoHS	EAC								

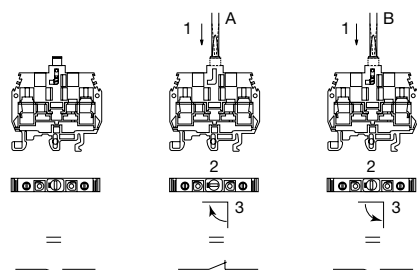

- A: Closing operation
B: Opening operation
1: Push
2: Turn
3: stop



Accessories

Description	Color	Type	Part Numbers	Pkg qty	Weight (1 pce) g
1 End stops 10 mm 0.394 in	Beige	BAM2	1SNA296351R0000	50	12.00
		BAR	1SNA164519R2400	50	11.00
2 End sections 2.8 mm 0.110 in	Beige	FEMT1	1SNA193137R0300	50	2.00
3 Lateral jumper bars 1 poles 24 A (IEC)	Grey	AD2.5	1SNA114205R2000	50	1.60
	Black	PC8-2	1SNA116538R1700	10	3.00
		PC8-10	1SNA163313R2400	10	14.00
4 Test plugs DIA 4 mm 0.157 in	White	FC4	1SNA167860R0100	10	10.00
5 Short circuit plugs With test socket DIA 4 mm 0.157 in	Beige	BNSTP1	1SNA196792R1700	20	14.00
6 Terminal block markers Blank card	White	RC810	1SNA234000R0200	10	8.20

E10/16.S railway terminal blocks

Disconnect with plug - 16 mm 0.63 in spacing

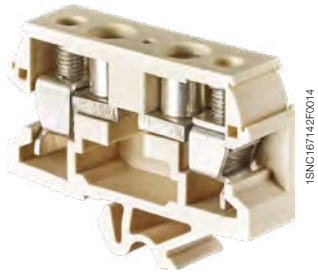

E10/16.S

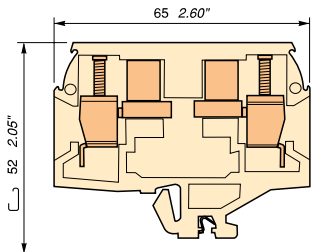

16 mm 0.63 in spacing

Description

- NF F 55-251 designation: ES 16,
- Sy SNCF 7 963 1109

Ordering details

Description	Color	Type	Part Numbers	Pkg qty	Weight (1 pce) g
Disconnect	Beige	E10/16.S	1SNA191296R1100	25	47.00

Main technical data

Connecting capacity		NF C	DIN	NF F 55-251	Mounting instructions	
1 conductor per clamp	Rigid: Solid/Stranded	0.5 ... 16 mm ²			Rail	G32
	Flexible without ferrule	0.5 ... 10 mm ²			Wire stripping length	14 mm 0.551 in
					Tool	Flat screwdriver Ø 5.5 mm Ø 0.217 in
Rated voltage	V AC	500 V	380 V	500 V	Torque	2.5 - 3 N.m 22.1 - 26.6 lb.in
	V DC	500 V	440 V	500 V		
Rated current				30 A		
Rated cross section		10 mm ²	10 mm ²	10 mm ²		

--	--	--	--	--	--	--	--	--	--



Accessories

Description	Color	Type	Part Numbers	Pkg qty	Weight (1 pce) g
1 End stops 10 mm 0.394 in	Beige	BAR	1SNA164519R2400	50	11.00
2 End sections 1.5 mm 0.059 in	Beige	FEE10-16	1SNA193449R2400	10	
3 Lateral jumper bars 2 poles		PC	1SNA168497R2300	10	7.00
5 Guide plugs	Beige	BIE	1SNA196915R0200	25	36.00
4 Component plugs	Black	SSB20	1SNA103098R2600	20	15.00
		SSB20T	1SNA103099R2700	20	17.00
6 Short circuit plugs With test socket DIA 4 mm 0.157 in	Beige	BNSTP1	1SNA196792R1700	20	14.00
7 Terminal block markers	Black	PE	1SNA103007R2300	25	13.00
	White	RC1010	1SNA238000R1600	10	1.30





Railway applications, terminal blocks

Screw clamp technology



Technologies presentation		220
Overview		224
Feed-through		
4 mm ² / 12 AWG	ZS4	228
6 mm ² / 10 AWG	ZS6	229
	ZS6-3S and ZS6-4S	with 3 and 4 connections 230-231
10 mm ² / 6 AWG	ZS10	232
16 mm ² / 4 AWG	ZS16	233
25 mm ² / 3 AWG	ZS25	234
35 mm ² / 0 AWG	ZS35	235
50 mm ² / 0 AWG	ZS50	236
70 mm ² / 00 AWG	ZS70	237
95 mm ² / 0000 AWG	ZS95	238
150 mm ² / 350 Kcmil	ZS150	239
240 mm ² / 240 Kcmil	ZS240	240
Ground		
4 mm ² / 12 AWG	ZS4-PE	241
6 mm ² / 10 AWG	ZS6-PE	242
	ZS6-3S-PE and ZS6-4S-PE	with 3 and 4 connections 243-244
10 mm ² / 6 AWG	ZS10-PE	245
16 mm ² / 4 AWG	ZS16-PE	246
25 mm ² / 3 AWG	ZS25-PE	247
35 mm ² / 2 AWG	ZS35-PE	248
35 mm ²	ZS35-PEN	+ neutral 249
50 mm ² / 0 AWG	ZS50-PE	250
70 mm ² / 00 AWG	ZS70-PE	251
95 mm ² / 0000 AWG	ZS95-PE	252
Disconnect with blade		
4 mm ² / 10 AWG	ZS4-S, ZS4-S-T, ZS4-S-R1 and ZS4-S-T-R1	with test 253-256
6 mm ² / 10 AWG	ZS6-S and ZS6-S-4S-T	with test 257-258
10 mm ² / 6 AWG	ZS10-S	259
Disconnect with plug		
4 mm ² / 10 AWG	ZS4-SP, ZS4-SP-T2, ZS4-SP-R1 and ZS4-SP-T2-R1	with test 260-263
10 mm ² / 6 AWG	ZS10-SP	264
Fuse and marshalling cabinets application overview		266
For 5x20 and 5x25 mm fuses		
4 mm ² / 10 AWG	ZS4-SF1 and ZS4-SF1-T	with test 268-269
	ZS4-SF1-R	with fuse indicator and test 270-271
	ZS4-R1	feed-through 272
	ZS4-S-R3	disconnect with lever 273
For 5x20 mm fuses and marshalling cabinets application		
4 mm ² / 10 AWG	ZS4-SF	274
	ZS4-SF-T	with test 275
	ZS4-SF-R	with fuse indicator and test 276-277
	ZS4-R2	feed-through 278
	ZS4-PE-R2	ground 279
	ZS4-S-R2	disconnect with lever 280
For 6.3x32 mm fuses (¼ x 1¼ in)		
10 mm ² / 6 AWG	ZS10-SF	281
	ZS10-SF-R	with fuse indicator 282
	ZS10-S-R2	disconnect with lever 283
Double deck		
4 mm ² / 12 AWG	ZS4-D2 and ZS4-D1	2 and 1 feed-through circuits 284-285
6 mm ² / 10 AWG	ZS6-D2 and ZS6-D1	2 and 1 feed-through circuits 286-287
	ZS6-D2-PE	1 feed-through circuit and 1 ground circuit 288
	ZS6-D1-PE	1 ground circuit 289
4 mm ² / 10 AWG	ZS4-D2-S	1 disconnect circuit and 1 feed-through circuit 290
	ZS4-D2-S-T	1 disconnect circuit + test and 1 feed-through circuit 291
	ZS4-D2-SF1	1 fuse circuit and 1 feed-through circuit 292
	ZS4-D2-SF1-R	1 fuse circuit + fuse indicator and 1 feed-through circuit 293
Triple deck		
4 mm ² / 12 AWG	ZS4-T3	3 feed-through circuits 294
4 mm ² / 10 AWG	ZS4-T3-R1	3 feed-through circuits 295
Component holder		
4 mm ² / 12 AWG	ZS4-D-CH-UD and ZS4-D-CH-DU	296-297
Test and measurement		
Overview		298
10 mm ² / 6 AWG	ZS10-ST	302
	ZS10-ST-1	for Potential Transformer circuits 303
	ZS10-ST-T4	for Current Transformer circuits 304
	ZS10-R1	feed-through 305
	ZS10-PE-R1	ground 306

Screw clamp technology - SNK series, terminal blocks

Features and benefits

TE Connectivity screw clamp technology benefits from 60 years of experience.

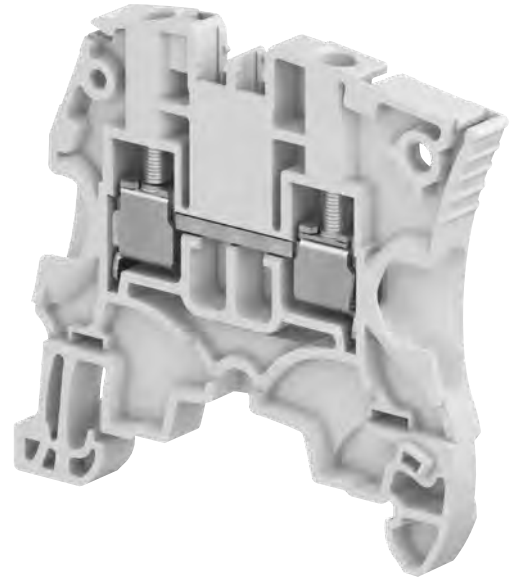

Speed up your projects

An optimized conductor guiding

Smooth connection process up to 2 conductors with or without ferrules thanks to funnel entry shape.

Also perfectly adapted to double ferrule shape **1**

Security: flap avoiding the insertion of cable underneath the clamp **2**.

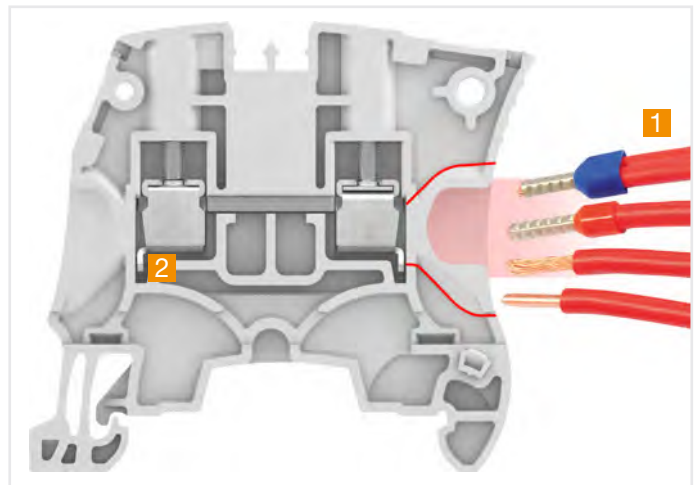

Engineered conductor entry

Better project identification

- Circuit identification is improved thanks to the 20% larger marking area
- Pre-mark by hand or with label on our flat marking surface and start immediately the wiring, before the final markers mounting
- Spare markers re-printing in case of modifications.

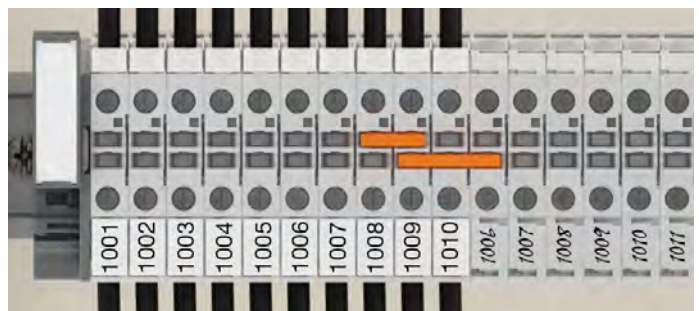

Clear circuit identification

1SNK161092S0201

Screw clamp technology - SNK series, terminal blocks

Features and benefits

Easy to install

Smart design facilitating assembly process.

Mounting, wiring, testing... made easy.

Avoid mounting and wiring errors: asymmetrical design allows immediate visual check in case of reversed terminal blocks.

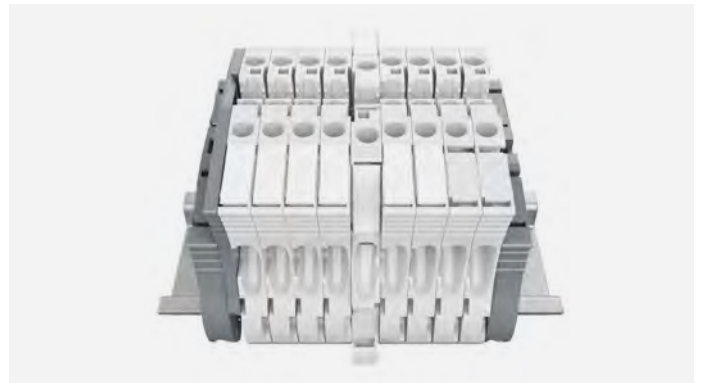

Asymmetrical design avoids mounting error

Minimize retightening campaigns

High torque resistance : the clamp is punched to increase the number of threads in contact by 30 % **1**.

The TE Connectivity exclusive anti-release system creates a controlled locking-screw effect reinforced by the 2 overlapping tabs that maintain the clamp parts **2**.

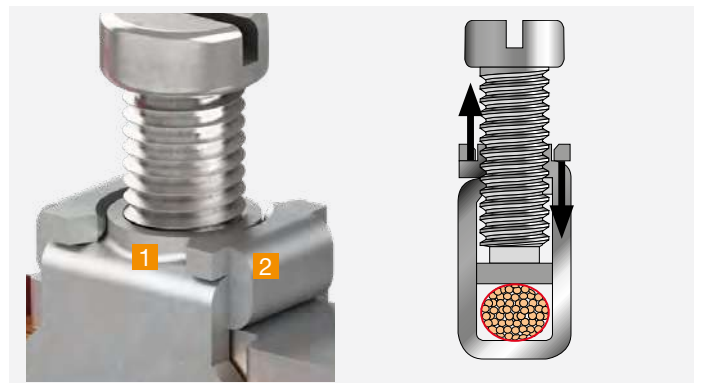

High torque resistance

Anti-release system

Faster accessories mounting

Save up to 70% mounting time thanks to screwless accessories: jumpers, component plugs, test devices, end stops and snap-in ground terminal blocks.

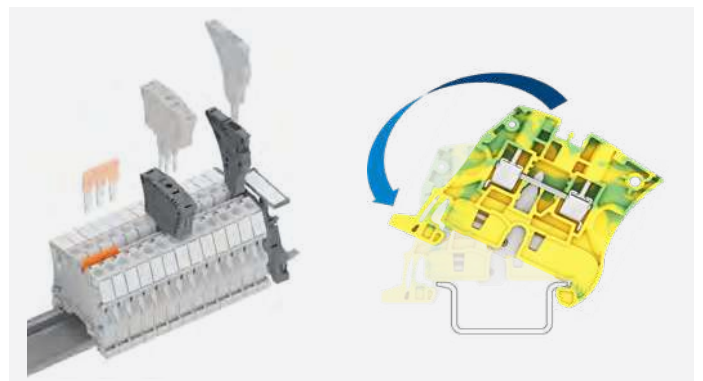

Screwless accessories

Snap-in ground terminal block for rapid installation

Screw clamp technology - SNK series, terminal blocks

Features and benefits

Easy to install

Smart design facilitating assembly process.

Mounting, wiring, testing... made easy.

Locking pin **1** allows quick and easy lock up to ten blocks in position at a time.

Closed jumper location allows great stiffness of the terminal block, optimal jumper guiding and avoids deflections while tightening.

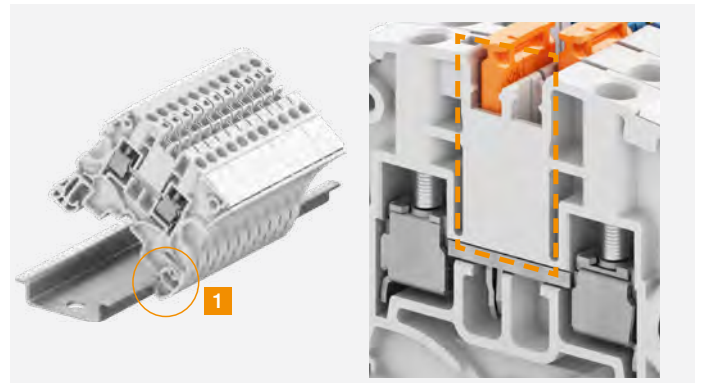

Lock up to ten blocks in position at a time

Closed jumper location for stiffness at a time

Smart accessories

Flexible test solutions from individual insulated test adapter to test connectors for complete assemblies testing.

- Direct plug-in into jumpers channels
- 5, 6, 8 mm spacing, mixing various spacing is possible
- 1000 V rating.

Component holder plugs for series or parallel component mounting (resistors, filters, diodes..).

Can be installed after wiring.

Series plug offers screwless component connection (no soldering).



Plug-in individual test adapter

Plug-in test connector



Series plug associated with disconnect blocks

Parallel plug to be installed between 2 blocks

Smart plug-in jumpers:

Pre-cut poles removable by hand: clean cut.

Insulated up to 1000 V (avoid use of separators).

Predefined shapes in molding to easily identify connected poles with a pen.

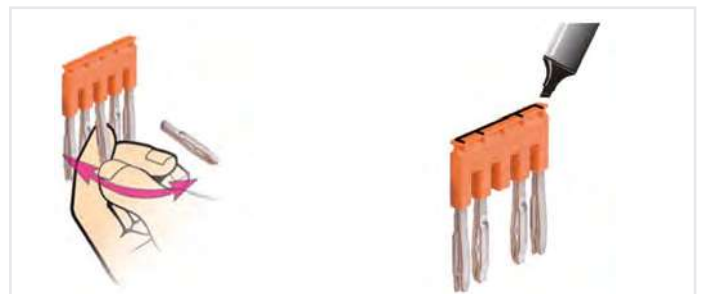

Pre-cut poles easy removable by hand

Predefined shape to identify connected poles

1SNK161092S0201

Screw clamp technology - SNK series, terminal blocks

Features and benefits

Optimized logistics

Reduce your accessories inventory by up to 50%

SNK PI-Spring, screw and pluggable ranges share the same accessories.

Reduced packaging adapted to the usage (20 items packaging for some references).

All end sections and circuit separators fit several types and sizes of blocks.

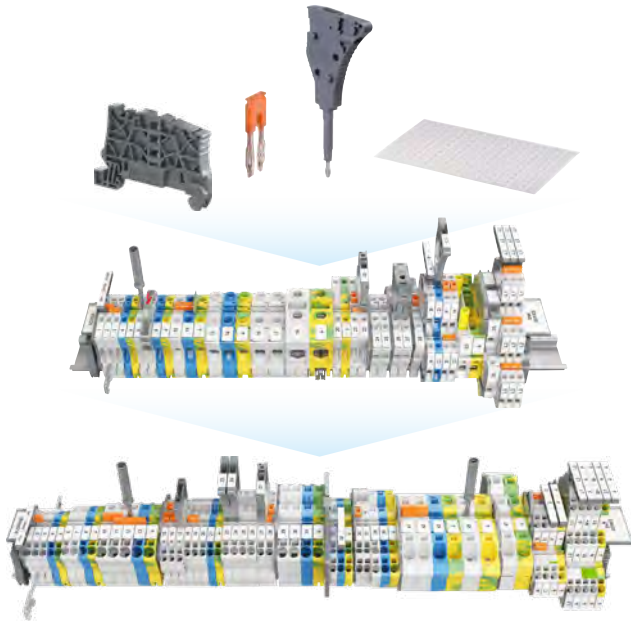

Shared accessories for SNK PI-Spring, screw and pluggable ranges



Stock only one end section for managing your assembly up to 240 mm²

Facilitate maintenance operations

Terminals can be individually removed from a terminal assembly equipped with markers: TE Connectivity markers become independent after strip mounting, TE Connectivity markers remain on terminal in any situation.

Reliable in harsh conditions

Qualified for worldwide markets, applications and for severe environments: vibration, shock, corrosion...

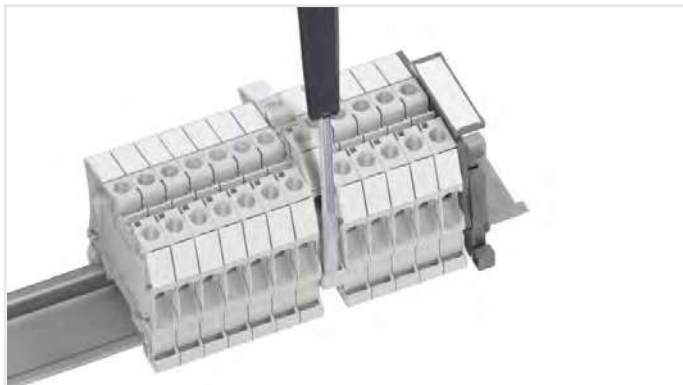

Maintenance operations facilitated



SNK series, terminal blocks

Screw clamp technology - Range overview from 4 to 240 mm² - 12 to 500 Kcmil

2 Connections

Single deck
Feed-through
Ground
Disconnect
Fuse

3 Connections

Single deck
Feed-through
Ground

4 Connections

Single deck
Feed-through
Ground
Disconnect

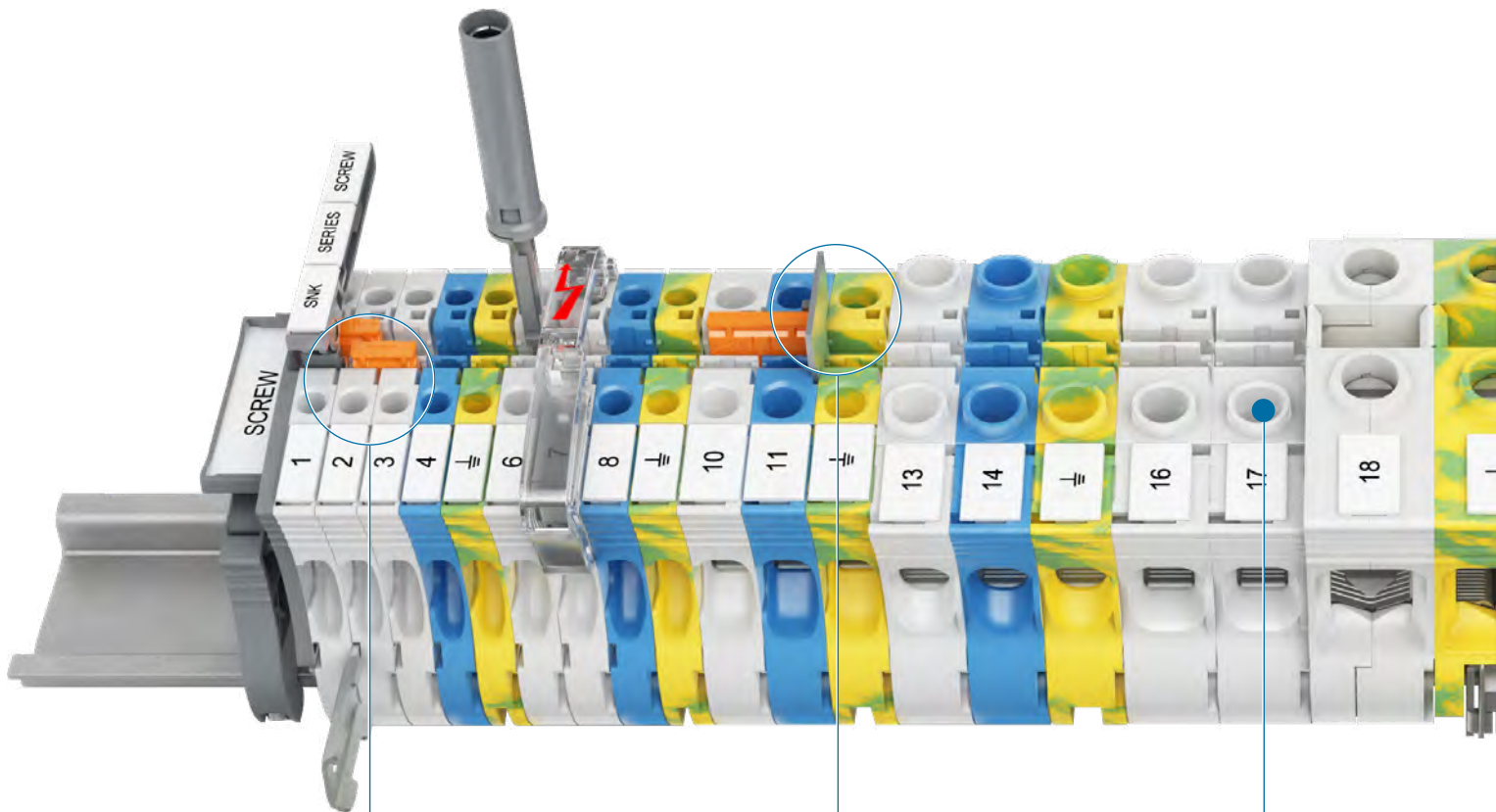

Double central channels
allows
multiconfigurations
(jumping, testing
and measuring)

Circuit separator
without spacing loss

Voltage test
screwdriver entry
point accepts
Category II probes

2x2  Connections

- Double deck**
- Feed-through
- Ground
- Disconnect
- Fuse
- Component holder

2  Connections

- Test and measurement**
- Feed-through
- Ground
- Disconnect

3x2  Connections

- Triple deck**
- Feed-through

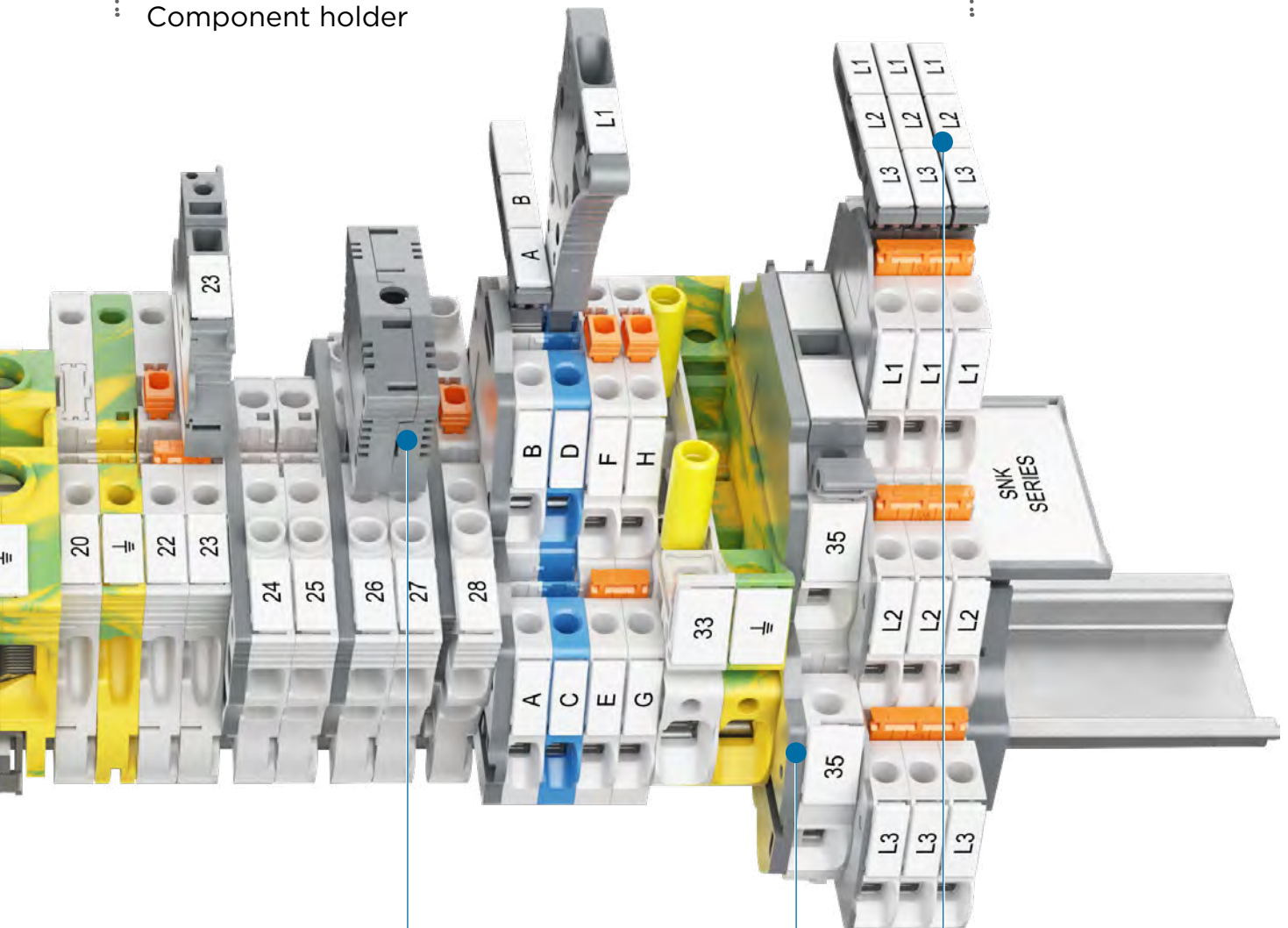

Plug
component holder

End section
can be used
as circuit separator

**Rotating label
holder**
easy plug-in in
jumper channel

SNK series, terminal blocks

Screw clamp technology



Feed-through

Ground

Section										
4 mm ²	12 AWG 10 AWG	ZS4					ZS4-PE			
6 mm ²	10 AWG	ZS6	ZS6-3S	ZS6-4S			ZS6-PE	ZS6-3S-PE	ZS6-4S-PE	
10 mm ²	6 AWG	ZS10					ZS10-PE			
16 mm ²	4 AWG	ZS16					ZS16-PE			
25 mm ²	3 AWG	ZS25					ZS25-PE			
35 mm ²	0 AWG 2 AWG				ZS35					ZS35-PE
50 mm ²	0 AWG				ZS50					ZS50-PE
70 mm ²	00 AWG				ZS70					ZS70-PE
95 mm ²	0000 AWG				ZS95					ZS95-PE
150 mm ²	350 Kcmil					ZS150				
240 mm ²	500 Kcmil					ZS240				



Disconnect with blade

Disconnect with plug

Section										
4 mm ²	10 AWG	ZS4-S	ZS4-S-T2		ZS4-S-R1	ZS4-S-T2-R1 ZS4-S-T2.3-R1	ZS4-SP	ZS4-SP-T2	ZS4-SP-R1	ZS4-SP-T2-R1
6 mm ²	10 AWG	ZS6-S		ZS6-S-4S-T2						
10 mm ²	6 AWG	ZS10-S					ZS10-SP			



For 5 x 20 mm fuses

Aligned for marshalling cabinets application

For 6.3 x 32 mm fuses (¼ x 1¼ in)

Aligned

Section											
4 mm ²	10 AWG	ZS4-SF	ZS4-SF-T2	ZS4-SF-R1	ZS4-SF-R2 ZS4-SF-R3 ZS4-SF-R4	ZS4-R2	ZS4-PE-R2	ZS4-S-R2			
10 mm ²	6 AWG								ZS10-SF	ZS10-SF-R1 ZS10-SF-R3	ZS10-S-R2

Clamp -
 Channels for jumpering or testing -
 Test socket -
 Blown-fuse indicator

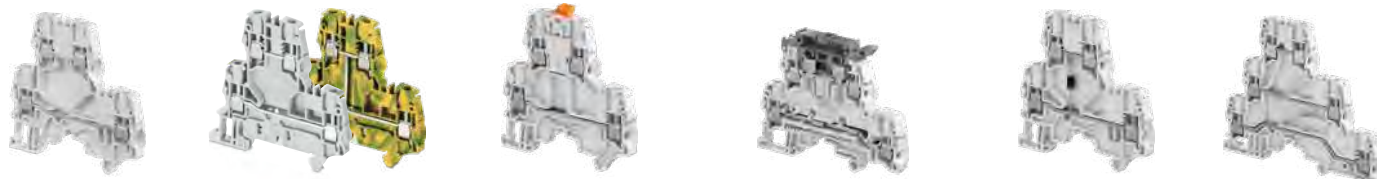

Double deck								Triple deck		
Feed-through		Ground		Disconnect with blade		For 5 x 20 mm and 5 x 25 mm fuses		Component holder		Feed-through
ZS4-D2	ZS4-D1	ZS6-D2-PE	ZS6-D1-PE	ZS4-D2-S	ZS4-D2-S-T2	ZS4-D2-SF1	ZS4-D2-SF1-R1 ZS4-D2-SF-R3	ZS4-D-CH-UD	ZS4-D-CH-DU	ZS4-T3 ZS4-T3-R1



Test & measurement			
Test disconnect with sliding link		Aligned with ZS10-ST	
ZS10-ST	ZS10-ST-T4 ZS10-ST-1	ZS10-R1	ZS10-PE-R1



For 5 x 20 mm and 5 x 25 mm fuses				Feed-through aligned with ZS4-SF1	
ZS4-SF1	ZS4-SF1-T2	ZS4-SF1-R1 ZS4-SF1-R3	ZS4-SF1-R2 ZS4-SF1-R4	ZS4-R1	ZS4-S-R3

ZS4 screw clamp terminal blocks

Feed-through - 5.2 mm 0.205 in spacing



1SNK161001E0014

ZS4

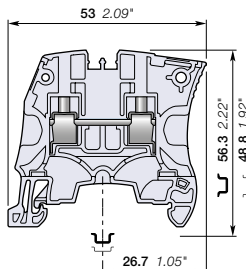

5.2 mm 0.205 in spacing

Description

- Save space by connecting conductors up to 4 mm² (without insulated ferrule, CB certified) 12 AWG in just 5.2 mm 0.205 in spacing,
- Perfectly adapted to solar applications: voltage is rated 1000 V AC / DC IEC.

Ordering details

Description	Color	Type	Part Number	Pkg qty	Weight (1 pce) g
Feed-through	Grey	ZS4	1SNK505010R0000	50	8.80
	Blue	ZS4-BL	1SNK505020R0000	50	8.80
	Orange	ZS4-OR	1SNK505030R0000	50	8.80
	Yellow	ZS4-YL	1SNK505060R0000	50	8.80
	Green	ZS4-GN	1SNK505061R0000	50	8.80
	Red	ZS4-RD	1SNK505062R0000	50	8.80
	Purple	ZS4-PR	1SNK505063R0000	50	8.80
	Brown	ZS4-BR	1SNK505064R0000	50	8.80
	White	ZS4-WH	1SNK505065R0000	50	8.80
	Black	ZS4-BK	1SNK505066R0000	50	8.80

Main technical data

Connecting capacity	IEC	UL - CSA	Mounting instructions		
1 conductor per clamp	Rigid: Solid/Stranded	0.2 ... 4 mm ²	24 ... 12 AWG	Rail	TH 35-7.5, TH 35-15
	Flexible without ferrule	0.22 ... 4 mm ²		Wire stripping length	10.5 mm, 0.412 in
	Flexible with non insulated ferrule	0.22 ... 4 mm ²	24 ... 12 AWG	Tool	Flat screwdriver Ø 3.5 mm Ø 0.138 in
	Flexible with insulated ferrule	0.22 ... 2.5 mm ²	24 ... 14 AWG		
	Gauge	A3-B3		Torque	0.6 Nm ± 0.1, 5.31 lb.in ± 0.885
2 conductors per clamp	Rigid: Solid/Stranded	0.2 ... 1.5 mm ²	24 ... 16 AWG		
	Flexible without ferrule	0.2 ... 1.5 mm ²	24 ... 16 AWG		
	Flexible with twin ferrule	0.22 ... 1.5 mm ²	20 A / 12 AWG		
Rated current / Rated cross section		32 A / 4 mm ²			
Rated short-time withstand current (1s)		480 A			
Short Circuit Current Rating (with specific conditions)			100 kA		
Rated voltage		1000 V	600 V		
Impulse withstand voltage		8000 V			
Protection		IP20	NEMA 1		
Increased safety Ex e		693 V 32 A IEC/EN 60079-7 - IM2 II 2 GD Ex eb I/IIIC - 600 V 20 A UL 60079-7 - Class I, Zone 1, AEx e II, Ex e II U			

The connecting capacity data for one Rigid: Solid/Stranded, or one Flexible conductor (when applicable) is a mandatory information required by IEC, UL and CSA standards (Copper conductors). All other data are provided as supplementary information only. For more details, please consult our CB, UL or CSA certificates and technical datasheet available on <http://www.TE.com>



Accessories

Description	Color	Type	Part Number	Pkg qty	Weight (1 pce) g	
1 End stops	Dark grey	BAM4	1SNK900001R0000	50	14.00	
2 End sections	Dark grey	ES4	1SNK505910R0000	20	2.20	
3 Jumper bars	Orange	2 poles	JB5-2	1SNK905302R0000	50	1.30
		3 poles	JB5-3	1SNK905303R0000	50	2.00
		4 poles	JB5-4	1SNK905304R0000	50	2.70
		5 poles	JB5-5	1SNK905305R0000	50	3.50
		10 poles	JB5-10	1SNK905310R0000	30	7.10
4 Cross spacing jumpers	Orange	3 poles	JB85-3	1SNK900603R0000	10	2.80
		50 poles	JB5-50	1SNK905350R0000	10	36.00
5 Circuit separators	Dark grey	0 mm	CS	1SNK900101R0000	20	0.20
		3 mm	CS-R1	1SNK900103R0000	20	5.20
6 Test adapters	Dark grey	For test plugs DIA 2 mm 0.079 in	TP2	1SNK900203R0000	20	1.70
		For test plugs DIA 4 mm 0.157 in	TP4	1SNK900205R0000	20	2.40
7 Test connectors	Dark grey	5.2 mm 0.205 in spacing	TC5	1SNK900200R0000	10	5.20
		End module, 5.2 mm 0.205 in	TC5-R1	1SNK900201R0000	10	5.20
8 Shield connectors		SHBS	1SNK900600R0000	20	3.50	
9 Protecting covers	Transparent	5.2 mm 0.205 in spacing	PL5	1SNK900618R0000	10	1.50
			MG-CPM 13 41790	1SNB041790R0512	1960	0.23
10 Terminal block markers	White	Blank marker	MC512	1SNK140000R0000	22	9.00
		Blank card	MC512PA	1SNK149999R0000	20	10.00
		Universal wire markers holder	UMH	1SNK900611R0000	10	0.20

Complete list of accessories is indicated in the terminal block datasheet including end stops. Some accessories such as jumper bars may modify the terminal block's ratings: Complete information available in the accessories section of the catalog.

Ground screw clamp terminal blocks

Description	Color	Type	Part Number	Pkg qty	Weight (1 pce) g
Ground	Green-yellow	ZS4-PE	1SNK505150R0000	20	12.10

Technical data valid for copper conductors only.

ZS6 screw clamp terminal blocks

Feed-through - 6 mm 0.236 in spacing

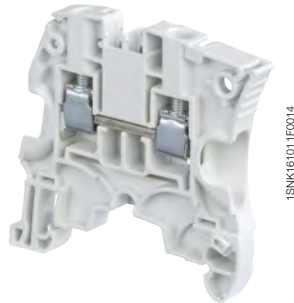

ZS6

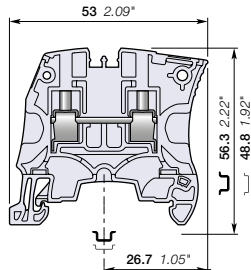

6 mm 0.236 in spacing

Description

Save space by connecting conductors up to 6 mm² (without insulated ferrule, CB certified) 10 AWG in just 6 mm 0.236 in spacing,

– Perfectly adapted to solar applications: voltage is rated 1000 V AC / DC IEC.

Ordering details

Description	Color	Type	Part Number	Pkg qty	Weight (1 pce) g
Feed-through	Grey	ZS6	1SNK506010R0000	50	10.60
	Blue	ZS6-BL	1SNK506020R0000	50	10.60
	Orange	ZS6-OR	1SNK506030R0000	50	10.60
	Yellow	ZS6-YL	1SNK506060R0000	50	10.60
	Green	ZS6-GN	1SNK506061R0000	50	10.60
	Red	ZS6-RD	1SNK506062R0000	50	10.60
	Purple	ZS6-PR	1SNK506063R0000	50	10.60
	Brown	ZS6-BR	1SNK506064R0000	50	10.60
	White	ZS6-WH	1SNK506065R0000	50	10.60
	Black	ZS6-BK	1SNK506066R0000	50	10.60

Main technical data

Connecting capacity	IEC	UL - CSA	Rail	TH 35-7.5, TH 35-15
1 conductor per clamp	Rigid: Solid/Stranded	0.2 ... 6 mm ²	24 ... 10 AWG	Wire stripping length
	Flexible without ferrule	0.2 ... 6 mm ²		10.5 mm 0.412 in
	Flexible with non insulated ferrule	0.22 ... 4 mm ²	24 ... 12 AWG	
	Flexible with insulated ferrule	0.22 ... 4 mm ²	24 ... 12 AWG	
	Gauge	A4-B3		
2 conductors per clamp	Rigid: Solid/Stranded	0.2 ... 2.5 mm ²	24 ... 14 AWG	Tool
	Flexible without ferrule	0.2 ... 2.5 mm ²		
	Flexible with twin ferrule	0.22 ... 2.5 mm ²	24 ... 14 AWG	
Rated current / Rated cross section	41 A / 6 mm ²	30 A / 10 AWG	Torque	0.85 Nm ± 0.15 7.52 lb.in ± 1.33
Rated short-time withstand current (1s)	720 A			
Short Circuit Current Rating (with specific conditions)		100 kA		
Rated voltage	1000 V	600 V		
Impulse withstand voltage	8000 V			
Protection	IP20	NEMA 1		

Mounting instructions

Increased safety Ex e 693 V 41 A IEC/EN 60079-7 - IM2 II 2 GD Ex eb I/II/III - 600 V 30 A UL 60079-7 - Class I, Zone 1, AEx e II, Ex e II U

The connecting capacity data for one Rigid: Solid/Stranded, or one Flexible conductor (when applicable) is a mandatory information required by IEC, UL and CSA standards (Copper conductors). All other data are provided as supplementary information only. For more details, please consult our CB, UL or CSA certificates and technical datasheet available on <http://www.TE.com>

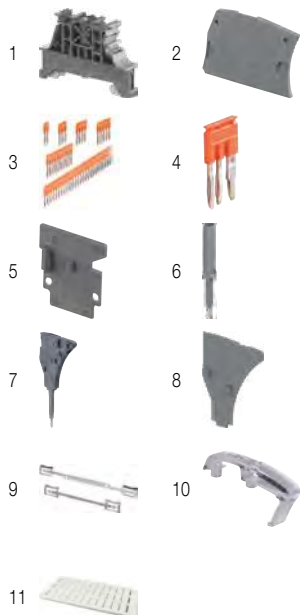

Accessories

Description	Color	Type	Part Number	Pkg qty	Weight (1 pce) g	
1 End stops	Dark grey	BAM4	1SNK900001R0000	50	14.00	
2 End sections	Dark grey	ES4	1SNK505910R0000	20	2.20	
3 Jumper bars	Orange	2 poles	JB6-2	1SNK906302R0000	50	1.30
		3 poles	JB6-3	1SNK906303R0000	50	2.10
		4 poles	JB6-4	1SNK906304R0000	50	2.90
		5 poles	JB6-5	1SNK906305R0000	50	3.60
		10 poles	JB6-10	1SNK906310R0000	20	7.40
		50 poles	JB6-50	1SNK906350R0000	10	38.10
4 Cross spacing jumpers	Orange	JB85-3	1SNK900603R0000	10	2.80	
5 Circuit separators	Dark grey	0 mm	CS	1SNK900101R0000	20	0.20
		3 mm	CS-R1	1SNK900103R0000	20	5.20
6 Test adapters	Dark grey	For test plugs DIA 2 mm 0.079 in	TP2	1SNK900203R0000	20	1.70
		For test plugs DIA 4 mm 0.157 in	TP4	1SNK900205R0000	20	2.40
7 Test connectors	Dark grey	TC5-R1	1SNK900201R0000	10	5.20	
8 Spacers	Dark grey	ES-TC6	1SNK900105R0000	10	0.80	
9 Shield connectors		SHBS	1SNK900600R0000	20	3.50	
10 Protecting covers	Transparent	PL6	1SNK900619R0000	10	1.80	
11 Terminal block markers	White	Blank marker	MG-CPM 13 41791	1680	0.27	
		Blank card	MC612	1SNK150000R0000	22	10.00
		Universal wire markers holder	UMH	1SNK900611R0000	10	0.20

Complete list of accessories is indicated in the terminal block datasheet including end stops.

Some accessories such as jumper bars may modify the terminal block's ratings: Complete information available in the accessories section of the catalog.

Ground screw clamp terminal blocks

Description	Color	Type	Part Number	Pkg qty	Weight (1 pce) g
Ground	Green-yellow	ZS6-PE	1SNK506150R0000	20	13.70



Technical data valid for copper conductors only.

ZS6-3S screw clamp terminal blocks

Feed-through with 3 connections - 6 mm 0.236 in spacing



1SNK16107500014

ZS6-3S

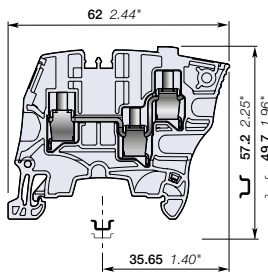

6 mm 0.236 in spacing

Description

- Recommended for energy markets and highly demanding applications requiring that only one conductor be connected per clamp,
- These blocks offer a high density connecting capacity (up to 3 connections) in a low profile and just 6 mm 0.236 in spacing.

Ordering details

Description	Color	Type	Part Number	Pkg qty	Weight (1 pce) g
Feed-through	Grey	ZS6-3S	1SNK506011R0000	50	11.80
	Blue	ZS6-3S-BL	1SNK506021R0000	50	11.80
	Yellow	ZS6-3S-YL	1SNK506067R0000	50	11.80

Main technical data

Connecting capacity		IEC	UL - CSA	Mounting instructions	
1 conductor per clamp	Rigid: Solid/Stranded	0.2 ... 6 mm ²	24 ... 10 AWG	Rail	TH 35-7.5, TH 35-15
	Flexible without ferrule	0.22 ... 6 mm ²		Wire stripping length	10.5 mm
	Flexible with non insulated ferrule	0.22 ... 4 mm ²	24 ... 12 AWG		0.413 in
	Flexible with insulated ferrule	0.22 ... 4 mm ²	24 ... 12 AWG	Tool	Flat screwdriver Ø 4 mm Ø 0.157 in
	Gauge	A4-B3			
2 conductors per clamp	Rigid: Solid/Stranded	0.2 ... 2.5 mm ²	24 ... 14 AWG	Torque	0.75 Nm ± 0.05 6.64 lb.in ± 0.443
	Flexible without ferrule	0.2 ... 2.5 mm ²			
	Flexible with twin ferrule	0.22 ... 2.5 mm ²	24 ... 14 AWG		
Rated current / Rated cross section		32 A / 4 mm ²	30 A / 10 AWG		
Maximum current / Maximum cross section		39 A / 6 mm ²			
Rated short-time withstand current (1s)		480 A			
Short Circuit Current Rating (with specific conditions)			100 kA		
Rated voltage		800 V	600 V		
Impulse withstand voltage		8000 V			
Protection		IP20	NEMA 1		
Increased safety Ex e		550 V 29 A IEC/EN 60079-7 - IM2 II 2 GD Ex eb III/IIIC - 600 V 30 A			

The connecting capacity data for one Rigid: Solid/Stranded, or one Flexible conductor (when applicable) is a mandatory information required by IEC, UL and CSA standards (Copper conductors). All other data are provided as supplementary information only. For more details, please consult our CB, UL or CSA certificates and technical datasheet available on <http://www.TE.com>



Accessories

Description	Color	Type	Part Number	Pkg qty	Weight (1 pce) g	
1 End stops	Dark grey	BAM4	1SNK900001R0000	50	14.00	
2 End sections	Dark grey	ES6-3S	1SNK505912R0000	20	2.50	
3 Jumper bars	Orange	2 poles	JB6-2	1SNK906302R0000	50	1.30
		3 poles	JB6-3	1SNK906303R0000	50	2.10
		4 poles	JB6-4	1SNK906304R0000	50	2.90
		5 poles	JB6-5	1SNK906305R0000	50	3.60
		10 poles	JB6-10	1SNK906310R0000	20	7.40
		50 poles	JB6-50	1SNK906350R0000	10	38.10
4 Cross spacing jumpers	Orange	JB85-3	1SNK900603R0000	10	2.80	
5 Circuit separators	Dark grey	0 mm	CS	1SNK900101R0000	20	0.20
		3 mm	CS-R1	1SNK900103R0000	20	5.20
6 Test adapters	Dark grey	For test plugs DIA 2 mm 0.079 in	TP2	1SNK900203R0000	20	1.70
		For test plugs DIA 4 mm 0.157 in	TP4	1SNK900205R0000	20	2.40
7 Test connectors	Dark grey	TC5-R1	1SNK900201R0000	10	5.20	
8 Spacers	Dark grey	ES-TC6	ES-TC6	1SNK900105R0000	10	0.80
			MG-CPM 13 41791	1SNB041791R0612	1680	0.27
			MC612	1SNK150000R0000	22	10.00
9 Terminal block markers	White	MC612PA	MC612PA	1SNK159999R0000	20	11.00
			Universal wire markers holder	UMH	1SNK900611R0000	10

Complete list of accessories is indicated in the terminal block datasheet including end stops.

Some accessories such as jumper bars may modify the terminal block's ratings: Complete information available in the accessories section of the catalog.

Ground screw clamp terminal blocks

Description	Color	Type	Part Number	Pkg qty	Weight (1 pce) g
Ground	Green-yellow	ZS6-3S-PE	1SNK506151R0000	25	16.20

Technical data valid for copper conductors only.

ZS6-4S screw clamp terminal blocks

Feed-through with 4 connections - 6 mm 0.236 in spacing



ZS6-4S

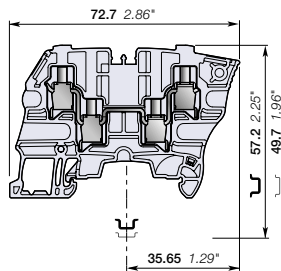

6 mm 0.236 in spacing

Description

- High density wiring (one potential distribution on 4 independent screw clamps) in a very low profile and just 6 mm 0.236 in spacing,
- Recommended for energy markets and highly demanding applications requiring that only one conductor be connected per clamp.

Ordering details

Description	Color	Type	Part Number	Pkg qty	Weight (1 pce) g
Feed-through	Grey	ZS6-4S	1SNK506012R0000	50	15.00
	Blue	ZS6-4S-BL	1SNK506022R0000	50	15.00
	Yellow	ZS6-4S-YL	1SNK506068R0000	50	15.00

Main technical data

Connecting capacity		IEC	UL - CSA	Mounting instructions	
1 conductor per clamp	Rigid: Solid/Stranded	0.2 ... 6 mm²	24 ... 10 AWG	Rail	TH 35-7.5, TH 35-15
	Flexible without ferrule	0.22 ... 6 mm²		Wire stripping length	10.5 mm 0.413 in
	Flexible with non insulated ferrule	0.22 ... 4 mm²	24 ... 12 AWG	Tool	Flat screwdriver Ø 4 mm Ø 0.157 in
	Flexible with insulated ferrule	0.22 ... 4 mm²	24 ... 12 AWG		
2 conductors per clamp	Rigid: Solid/Stranded	0.2 ... 2.5 mm²	24 ... 14 AWG	Torque	0.75 Nm ± 0.05 6.64 lb.in ± 0.443
	Flexible without ferrule	0.2 ... 2.5 mm²			
	Flexible with twin ferrule	0.22 ... 2.5 mm²	24 ... 14 AWG		
Rated current / Rated cross section		32 A / 4 mm²	30 A / 10 AWG		
Maximum current / Maximum cross section		39 A / 6 mm²			
Rated short-time withstand current (1s)		480 A			
Short Circuit Current Rating (with specific conditions)		100 kA			
Rated voltage		800 V	600 V		
Impulse withstand voltage		8000 V			
Protection		IP20	NEMA 1		
Increased safety Ex e		550 V 29 A IEC/EN 60079-7 - IM2 II 2 GD Ex eb I/II/IIIc - 600 V 30 A			

The connecting capacity data for one Rigid: Solid/Stranded, or one Flexible conductor (when applicable) is a mandatory information required by IEC, UL and CSA standards (Copper conductors). All other data are provided as supplementary information only. For more details, please consult our CB, UL or CSA certificates and technical datasheet available on <http://www.TE.com>



Accessories

Description	Color	Type	Part Number	Pkg qty	Weight (1 pce) g	
1 End stops	Dark grey	BAM4	1SNK900001R0000	50	14.00	
2 End sections	Dark grey	ES6-4S	1SNK505911R0000	20	3.10	
3 Jumper bars	Orange	2 poles	JB6-2	1SNK906302R0000	50	1.30
		3 poles	JB6-3	1SNK906303R0000	50	2.10
		4 poles	JB6-4	1SNK906304R0000	50	2.90
		5 poles	JB6-5	1SNK906305R0000	50	3.60
		10 poles	JB6-10	1SNK906310R0000	20	7.40
		50 poles	JB6-50	1SNK906350R0000	10	38.10
4 Cross spacing jumpers	Orange	JB85-3	1SNK900603R0000	10	2.80	
5 Circuit separators	Dark grey	0 mm	CS	1SNK900101R0000	20	0.20
		3 mm	CS-R1	1SNK900103R0000	20	5.20
6 Test adapters	Dark grey	For test plugs DIA 2 mm 0.079 in	TP2	1SNK900203R0000	20	1.70
		For test plugs DIA 4 mm 0.157 in	TP4	1SNK900205R0000	20	2.40
7 Test connectors	Dark grey	TC5-R1	1SNK900201R0000	10	5.20	
8 Spacers	Dark grey	ES-TC6	1SNK900105R0000	10	0.80	
9 Terminal block markers	White	Blank marker	MG-CPM 13 41791	1SNB041791R0612	1680	0.27
		Blank card	MC612	1SNK150000R0000	22	10.00
			MC612PA	1SNK159999R0000	20	11.00
		Universal wire markers holder	Grey	UMH	1SNK900611R0000	10

Complete list of accessories is indicated in the terminal block datasheet including end stops.

Some accessories such as jumper bars may modify the terminal block's ratings: Complete information available in the accessories section of the catalog.

Ground screw clamp terminal blocks

Description	Color	Type	Part Number	Pkg qty	Weight (1 pce) g
Ground	Green-yellow	ZS6-4S-PE	1SNK506152R0000	25	19.40

Technical data valid for copper conductors only.

ZS10 screw clamp terminal blocks

Feed-through - 8 mm 0.315 in spacing

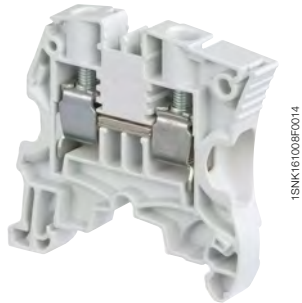

ZS10

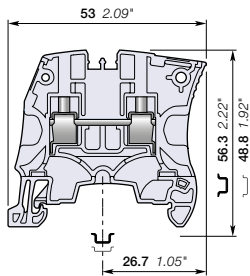

8 mm 0.315 in spacing

Description

- Save space by connecting conductors up to 10 mm² (without insulated ferrule, CB certified) 6 AWG in just 8 mm 0.315 in spacing,
- Perfectly adapted to solar applications: voltage is rated 1000 V AC / DC IEC.

Ordering details

Description	Color	Type	Part Number	Pkg qty	Weight (1 pce) g
Feed-through	Grey	ZS10	1SNK508010R0000	50	14.10
	Blue	ZS10-BL	1SNK508020R0000	50	14.10
	Orange	ZS10-OR	1SNK508030R0000	50	14.10
	Yellow	ZS10-YL	1SNK508060R0000	50	14.10
	Green	ZS10-GN	1SNK508061R0000	50	14.10
	Red	ZS10-RD	1SNK508062R0000	50	14.10
	Purple	ZS10-PR	1SNK508063R0000	50	14.10
	Brown	ZS10-BR	1SNK508064R0000	50	14.10
	White	ZS10-WH	1SNK508065R0000	50	14.10
	Black	ZS10-BK	1SNK508066R0000	50	14.10

Main technical data

Connecting capacity		IEC	UL - CSA	Mounting instructions	
1 conductor per clamp	Rigid: Solid/Stranded	0.5 ... 10 mm ²	24 ... 6 AWG	Rail	TH 35-7.5, TH 35-15
	Flexible without ferrule	0.5 ... 10 mm ²		Wire stripping length	12 mm 0.472 in
	Flexible with non insulated ferrule	0.5 ... 10 mm ²	24 ... 8 AWG	Tool	Flat screwdriver Ø 4 mm Ø 0.157 in
	Flexible with insulated ferrule	0.5 ... 6 mm ²	24 ... 10 AWG		
	Gauge	A5-B5		Torque	1.3 Nm ± 0.3 11.5 lb.in ± 2.65
2 conductors per clamp	Rigid: Solid/Stranded	0.5 ... 4 mm ²	20 ... 12 AWG		
	Flexible without ferrule	0.5 ... 4 mm ²			
	Flexible with twin ferrule	0.5 ... 4 mm ²	20 ... 12 AWG		
Rated current / Rated cross section		57 A / 10 mm ²	42 A / 6 AWG		
Rated short-time withstand current (1s)		1200 A			
Short Circuit Current Rating (with specific conditions)			100 kA		
Rated voltage		1000 V	600 V		
Impulse withstand voltage		8000 V			
Protection		IP20	NEMA 1		

Increased safety Ex e 693 V 57 A IEC/EN 60079-7 - IM2 II 2 GD Ex eb III/IIIC - 600 V 42 A UL 60079-7 - Class I, Zone 1, AEx e II, Ex e II U

The connecting capacity data for one Rigid: Solid/Stranded, or one Flexible conductor (when applicable) is a mandatory information required by IEC, UL and CSA standards (Copper conductors). All other data are provided as supplementary information only. For more details, please consult our CB, UL or CSA certificates and technical datasheet available on <http://www.TE.com>



Accessories

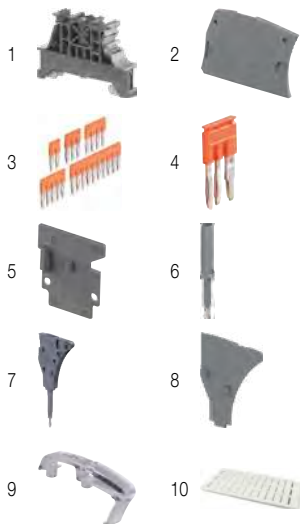

Description	Color	Type	Part Number	Pkg qty	Weight (1 pce) g	
1 End stops	Dark grey	BAM4	1SNK900001R0000	50	14.00	
2 End sections	Dark grey	ES4	1SNK505910R0000	20	2.20	
3 Jumper bars	Orange	2 poles	JB8-2	1SNK908302R0000	50	2.70
		3 poles	JB8-3	1SNK908303R0000	50	4.10
		4 poles	JB8-4	1SNK908304R0000	50	5.60
		5 poles	JB8-5	1SNK908305R0000	40	7.00
		10 poles	JB8-10	1SNK908310R0000	20	14.20
4 Cross spacing jumpers	Orange	JB85-3	1SNK900603R0000	10	2.80	
5 Circuit separators	Dark grey	0 mm	CS	1SNK900101R0000	20	0.20
		3 mm	CS-R1	1SNK900103R0000	20	5.20
6 Test adapters	Dark grey	For test plugs DIA 2 mm 0.079 in	TP2	1SNK900203R0000	20	1.70
		For test plugs DIA 4 mm 0.157 in	TP4	1SNK900205R0000	20	2.40
7 Test connectors	Dark grey	5.2 mm 0.205 in spacing	TC5	1SNK900200R0000	10	5.20
		End module, 5.2 mm 0.205 in	TC5-R1	1SNK900201R0000	10	5.20
8 Spacers	Dark grey	ES-TC8	1SNK900104R0000	10	1.40	
9 Protecting covers	Transparent	PL8	1SNK900620R0000	10	2.60	
10 Terminal block markers	White	Blank marker	MG-CPM 13 41791	1SNB041791R0612	1680	0.27
		Blank card	MC812	1SNK160000R0000	22	10.00
			MC812PA	1SNK169999R0000	20	14.00
		Universal wire markers holder	Grey	UMH	1SNK900611R0000	10

Complete list of accessories is indicated in the terminal block datasheet including end stops.

Some accessories such as jumper bars may modify the terminal block's ratings: Complete information available in the accessories section of the catalog.

Ground screw clamp terminal blocks

Description	Color	Type	Part Number	Pkg qty	Weight (1 pce) g
Ground	Green-yellow	ZS10-PE	1SNK508150R0000	20	22.50

Technical data valid for copper conductors only.

ZS16 screw clamp terminal blocks

Feed-through - 10 mm 0.394 in spacing

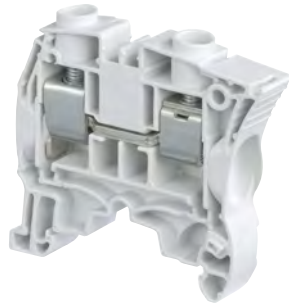
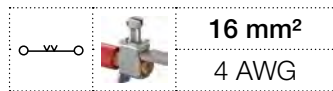

ZS16

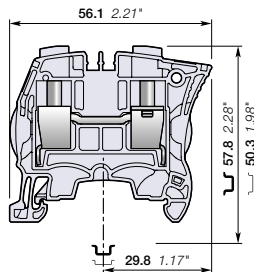

10 mm 0.394 in spacing

Description

- Save space by connecting conductors up to 16 mm² (without insulated ferrule, CB certified) 4 AWG in just 10 mm 0.394 in spacing,
- Perfectly adapted to solar applications: voltage is rated 1000 V AC / DC IEC.

Ordering details

Description	Color	Type	Part Number	Pkg qty	Weight (1 pce) g
Feed-through	Grey <input type="checkbox"/>	ZS16	1SNK510010R0000	25	20.20
	Blue <input type="checkbox"/>	ZS16-BL	1SNK510020R0000	25	20.20
	Orange <input type="checkbox"/>	ZS16-OR	1SNK510030R0000	25	20.20

Main technical data

Connecting capacity		IEC	UL - CSA	Mounting instructions	
1 conductor per clamp	Rigid: Solid/Stranded	0.5 ... 16 mm ²	24 ... 4 AWG	Rail	TH 35-7.5, TH 35-15
	Flexible without ferrule	0.5 ... 16 mm ²		Wire stripping length	13.5 mm 0.531 in
	Flexible with non insulated ferrule	0.5 ... 16 mm ²	24 ... 4 AWG		
	Flexible with insulated ferrule	0.5 ... 10 mm ²	24 ... 8 AWG		
	Gauge	A6-B6			
2 conductors per clamp	Rigid: Solid/Stranded	0.5 ... 6 mm ²	20 ... 10 AWG	Tool	Flat screwdriver Ø 5.5 mm Ø 0.217 in
	Flexible without ferrule	0.5 ... 6 mm ²	20 ... 10 AWG		
	Flexible with twin ferrule	0.5 ... 6 mm ²	20 ... 10 AWG		
Rated current / Rated cross section		76 A / 16 mm ²	67 A / 4 AWG	Torque	1.8 Nm ± 0.2 15.9 lb.in ± 1.77
Rated short-time withstand current (1s)		1920 A			
Short Circuit Current Rating (with specific conditions)			100 kA		
Rated voltage		1000 V	600 V		
Impulse withstand voltage		8000 V			
Protection		IP20	NEMA 1		
Increased safety Ex e		693 V 76 A IEC/EN 60079-7 - IM2 II 2 GD Ex eb I/IIIC - 600 V 67 A UL 60079-7 - Class I, Zone 1, AEx e II, Ex e II U			

The connecting capacity data for one Rigid: Solid/Stranded, or one Flexible conductor (when applicable) is a mandatory information required by IEC, UL and CSA standards (Copper conductors). All other data are provided as supplementary information only. For more details, please consult our CB, UL or CSA certificates and technical datasheet available on <http://www.TE.com>



Accessories

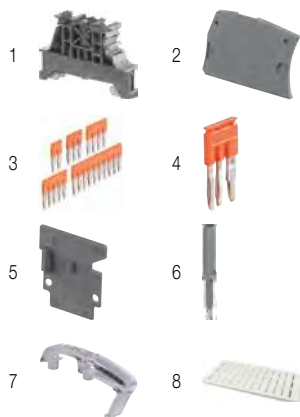

Description	Color	Type	Part Number	Pkg qty	Weight (1 pce) g	
1 End stops	Dark grey <input type="checkbox"/>	BAM4	1SNK900001R0000	50	14.00	
2 End sections	Dark grey <input type="checkbox"/>	ES4	1SNK505910R0000	20	2.20	
3 Jumper bars	Orange <input type="checkbox"/>	2 poles	JB10-2	1SNK910302R0000	50	4.60
		3 poles	JB10-3	1SNK910303R0000	50	7.10
		4 poles	JB10-4	1SNK910304R0000	40	9.40
		5 poles	JB10-5	1SNK910305R0000	30	12.00
		10 poles	JB10-10	1SNK910310R0000	20	24.00
4 Cross spacing jumpers	Orange <input type="checkbox"/>	JB85-3	1SNK900603R0000	10	2.80	
5 Circuit separators	Dark grey <input type="checkbox"/>	0 mm	CS	1SNK900101R0000	20	0.20
		3 mm	CS-R1	1SNK900103R0000	20	5.20
6 Test adapters	Dark grey <input type="checkbox"/>	For test plugs DIA 2 mm 0.079 in	TP2	1SNK900203R0000	20	1.70
		For test plugs DIA 4 mm 0.157 in	TP4	1SNK900205R0000	20	2.40
7 Protecting covers	Transparent <input type="checkbox"/>	10 mm 0.394 in spacing	PL10	1SNK900621R0000	10	3.10
8 Terminal block markers	White <input type="checkbox"/>	Blank marker	MG-CPM 13 41791	1SNK9001791R0612	1680	0.27
			MC812	1SNK160000R0000	22	10.00
			MC812PA	1SNK169999R0000	20	14.00
			Universal wire markers holder	UMH	1SNK900611R0000	10

Complete list of accessories is indicated in the terminal block datasheet including end stops. Some accessories such as jumper bars may modify the terminal block's ratings. Complete information available in the accessories section of the catalog.

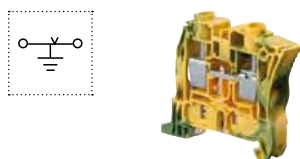

Ground screw clamp terminal blocks

Description	Color	Type	Part Number	Pkg qty	Weight (1 pce) g
Ground	Green-yellow <input type="checkbox"/>	ZS16-PE	1SNK510150R0000	20	32.00

Technical data valid for copper conductors only.

ZS25 screw clamp terminal blocks

Feed-through - 12 mm 0.472 in spacing

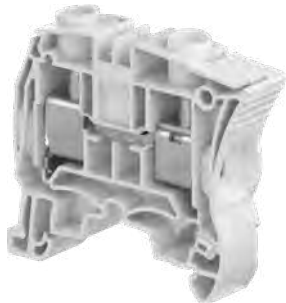

ZS25

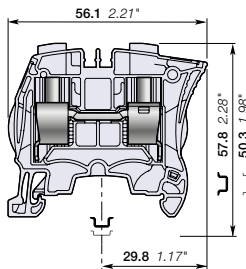

12 mm 0.472 in spacing

Description

- Save space by connecting conductors up to 25 mm² (without insulated ferrule, CB certified) 3 AWG in just 12 mm 0.472 in spacing,
- Perfectly adapted to solar applications: voltage is rated 1000 V AC / DC IEC.

Ordering details

Description	Color	Type	Part Number	Pkg qty	Weight (1 pce) g
Feed-through	Grey <input type="checkbox"/>	ZS25	1SNK512010R0000	25	21.40
	Blue <input type="checkbox"/>	ZS25-BL	1SNK512020R0000	25	21.40
	Yellow <input type="checkbox"/>	ZS25-YL	1SNK512060R0000	25	21.40

Main technical data

Connecting capacity		IEC	UL - CSA	Mounting instructions	
1 conductor per clamp	Rigid: Solid/Stranded	0.5 ... 25 mm ²	24 ... 3 AWG	Rail	TH 35-7.5, TH 35-15
	Flexible without ferrule	0.5 ... 25 mm ²		Wire stripping length	13.5 mm 0.531 in
	Flexible with non insulated ferrule	0.5 ... 16 mm ²	24 ... 4 AWG		
	Flexible with insulated ferrule	0.5 ... 16 mm ²	24 ... 8 AWG		
	Gauge	A6-B6			
2 conductors per clamp	Rigid: Solid/Stranded	0.5 ... 10 mm ²	20 ... 10 AWG	Tool	Flat screwdriver Ø 5.5 mm Ø 0.217 in
	Flexible without ferrule	0.5 ... 10 mm ²	20 ... 10 AWG		
	Flexible with twin ferrule	0.5 ... 10 mm ²	20 ... 10 AWG		
Rated current / Rated cross section		76 A / 16 mm ²	100 A / 3 AWG	Torque	1.8 Nm ± 0.2 15.9 lb.in ± 1.77
Maximum current / Maximum cross section		101 A / 25 mm ²			
Rated short-time withstand current (1s)		1920 A			
Short Circuit Current Rating (with specific conditions)			100 kA		
Rated voltage		1000 V	600 V		
Impulse withstand voltage		8000 V			
Protection		IP20	NEMA 1		
Increased safety Ex e		693 V 69 A IEC/EN 60079-7 - IM2 II 2 GD Ex eb I/II/IIIc - 600 V 100 A			

The connecting capacity data for one Rigid: Solid/Stranded, or one Flexible conductor (when applicable) is a mandatory information required by IEC, UL and CSA standards (Copper conductors). All other data are provided as supplementary information only. For more details, please consult our CB, UL or CSA certificates and technical datasheet available on <http://www.TE.com>



Accessories

Description	Color	Type	Part Number	Pkg qty	Weight (1 pce) g	
1 End stops 10 mm 0.394 in	Dark grey <input type="checkbox"/>	BAM4	1SNK900001R0000	50	14.00	
2 End sections 2.2 mm 0.087 in	Dark grey <input type="checkbox"/>	ES4	1SNK505910R0000	20	2.20	
3 Jumper bars	Orange <input type="checkbox"/>	2 poles 76 A (IEC)	JB12-2	1SNK912302R0000	50	4.90
		3 poles 76 A (IEC)	JB12-3	1SNK912303R0000	50	7.60
		5 poles 76 A (IEC)	JB12-5	1SNK912305R0000	20	12.90
4 Cross spacing jumpers 3 poles 32 A (IEC)	Orange <input type="checkbox"/>	JB85-3	1SNK900603R0000	10	2.80	
5 Circuit separators	Dark grey <input type="checkbox"/>	0 mm 0 in	CS	1SNK900101R0000	20	0.20
		3 mm 0.118 in	CS-R1	1SNK900103R0000	20	5.20
6 Test adapters	Dark grey <input type="checkbox"/>	For test plugs DIA 2 mm 0.079 in	TP2	1SNK900203R0000	20	1.70
		For test plugs DIA 4 mm 0.157 in	TP4	1SNK900205R0000	20	2.40
7 Protecting covers 10 mm 0.394 in spacing	Transparent <input type="checkbox"/>	PL10	1SNK900621R0000	10	3.10	
8 Terminal block markers	White <input type="checkbox"/>	Blank marker	MG-CPM 13 41791	1SNB041791R0612	1680	0.27
		Blank card	MC812	1SNK160000R0000	22	10.00
			MC812PA	1SNK169999R0000	20	14.00
		Universal wire markers holder	Grey <input type="checkbox"/>	UMH	1SNK900611R0000	10

Complete list of accessories is indicated in the terminal block datasheet including end stops. Some accessories such as jumper bars may modify the terminal block's ratings: Complete information available in the accessories section of the catalog.



Ground screw clamp terminal blocks

Description	Color	Type	Part Number	Pkg qty	Weight (1 pce) g
Ground Profile aligned with ZS25	Green-yellow <input type="checkbox"/>	ZS25-PE	1SNK512150R0000	20	38.00

Technical data valid for copper conductors only.

ZS35 screw clamp terminal blocks

Feed-through - 16 mm 0.630 in spacing



ZS35

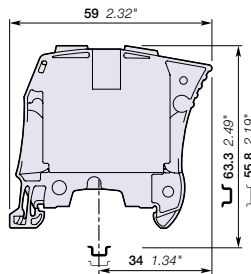

16 mm 0.630 in spacing

Description

Closed terminal block:

- No end section needed,
- Optimized rigidity,
- Perfectly adapted to solar applications: voltage is rated 1000 V AC / DC IEC.

Ordering details

Description	Color	Type	Part Number	Pkg qty	Weight (1 pce) g
Feed-through Closed block	Grey <input type="checkbox"/>	ZS35	1SNK516010R0000	20	53.40
	Blue <input type="checkbox"/>	ZS35-BL	1SNK516020R0000	20	53.40
	Orange <input type="checkbox"/>	ZS35-OR	1SNK516030R0000	20	53.40

Main technical data

Connecting capacity		IEC	UL - CSA	Mounting instructions	
1 conductor per clamp	Rigid: Solid/Stranded	6 ... 35 mm ²	10 ... 0 AWG	Rail	TH 35-7.5, TH 35-15
	Flexible without ferrule	6 ... 35 mm ²		Wire stripping length	17 mm 0.669 in
	Flexible with non insulated ferrule	4 ... 35 mm ²	10 ... 2 AWG		
	Flexible with insulated ferrule	4 ... 35 mm ²	10 ... 2 AWG		
	Gauge	A9-B9			
2 conductors per clamp	Rigid: Solid/Stranded	6 ... 16 mm ²	10 ... 6 AWG	Tool	Flat screwdriver Ø 6.5 mm Ø 0.256 in
	Flexible without ferrule	6 ... 16 mm ²			
	Flexible with twin ferrule	4 ... 10 mm ²	12 ... 8 AWG		
Rated current / Rated cross section		125 A / 35 mm ²	150 A / 0 AWG	Torque	2.9 Nm ± 0.1 25.7 lb.in ± 0.885
Rated short-time withstand current (1s)		4200 A			
Short Circuit Current Rating (with specific conditions)			100 kA		
Rated voltage		1000 V	600 V		
Impulse withstand voltage		8000 V			
Protection		IP10	NEMA 1		
Increased safety Ex e		693 V 125 A IEC/EN 60079-7 - IM2 II 2 GD Ex eb I/II/III - 600 V 150 A UL 60079-7 - Class I, Zone 1, AEx e II			

The connecting capacity data for one Rigid: Solid/Stranded, or one Flexible conductor (when applicable) is a mandatory information required by IEC, UL and CSA standards (Copper conductors). All other data are provided as supplementary information only. For more details, please consult our CB, UL or CSA certificates and technical datasheet available on <http://www.TE.com>



Accessories

Description	Color	Type	Part Number	Pkg qty	Weight (1 pce) g	
1 End stops	Dark grey <input type="checkbox"/>	BAZH1	1SNK900102R0000	20	24.00	
2 Jumper bars	Orange <input type="checkbox"/>	10 mm 0.394 in	JB16-2	1SNK916302R0000	10	10.00
		2 poles 125 A (IEC)	JB16-3	1SNK916303R0000	10	16.00
		3 poles 125 A (IEC)	JB16-4	1SNK916304R0000	10	22.00
		4 poles 125 A (IEC)	JB16-5	1SNK916305R0000	10	28.00
		5 poles 125 A (IEC)	JB16-10	1SNK916310R0000	10	56.60
3 Circuit separators	Dark grey <input type="checkbox"/>	CS-R1	1SNK900103R0000	20	5.20	
4 Protecting covers	Transparent <input type="checkbox"/>	3 mm 0.118 in	PL16	1SNK900622R0000	10	4.60
		16 mm 0.630 in spacing				
5 Terminal block markers	White <input type="checkbox"/>	Blank marker	MG-CPM 13 41791	1SNB041791R0612	1680	0.27
		Blank card	MC812	1SNK160000R0000	22	10.00
		Universal wire markers holder	MC812PA	1SNK169999R0000	20	14.00
	Grey <input type="checkbox"/>	UMH	1SNK900611R0000	10	0.20	

Complete list of accessories is indicated in the terminal block datasheet including end stops.

Some accessories such as jumper bars may modify the terminal block's ratings: Complete information available in the accessories section of the catalog.

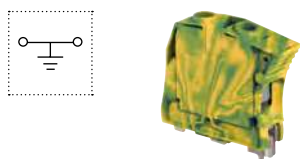

Ground screw clamp terminal blocks

Description	Color	Type	Part Number	Pkg qty	Weight (1 pce) g
Ground	Green-yellow <input type="checkbox"/>	ZS35-PE	1SNK516150R0000	20	81.80

Technical data valid for copper conductors only.

ZS50 screw clamp terminal blocks

Feed-through - 16 mm 0.630 in spacing



1SNK161084V0014

ZS50

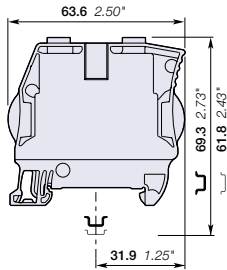

16 mm 0.630 in spacing

Description

Combine high performance with compact dimensions:

- Connect conductors up to 50 mm² (CB certified) 0 AWG in just 16 mm 0.630 in spacing,
- Perfectly adapted to solar applications: 1250 V DC (1000 V AC) IEC and 1000 V UL,
- Closed terminal block: no end section needed, optimized rigidity.

Ordering details

Description	Color	Type	Part Number	Pkg qty	Weight (1 pce) g
Feed-through Closed block	Grey	ZS50	1SNK516011R0000	20	52.90
	Blue	ZS50-BL	1SNK516021R0000	20	52.90
	Yellow	ZS50-YL	1SNK516060R0000	20	52.90
	Red	ZS50-RD	1SNK516063R0000	20	52.90
	Black	ZS50-BK	1SNK516064R0000	20	52.90

Main technical data

Connecting capacity		IEC	UL - CSA	Rail		TH 35-7.5, TH 35-15
1 conductor per clamp	Rigid: Solid/Stranded	1 ... 50 mm ²	18 ... 0 AWG	Wire stripping length		17 mm 0.669 in
	Flexible without ferrule	1 ... 50 mm ²	18 ... 0 AWG			
	Flexible with non insulated ferrule	1 ... 50 mm ²	18 ... 0 AWG			
	Flexible with insulated ferrule	1 ... 50 mm ²	18 ... 0 AWG			
	Gauge	Dia. 11				
2 conductors per clamp	Rigid: Solid/Stranded	1 ... 25 mm ²	18 ... 4 AWG	Tool		Flat screwdriver Ø 6.5 mm Ø 0.256 in
	Flexible without ferrule	1 ... 25 mm ²	18 ... 4 AWG			
	Flexible with twin ferrule	1 ... 16 mm ²	18 ... 4 AWG			
Rated current / Rated cross section		150 A / 50 mm ²	140 A / 0 AWG	Torque		3 Nm ± 0.50 26.6 lb.in ± 4.43
Rated short-time withstand current (1s)		6000 A				
Short Circuit Current Rating (with specific conditions)			100 kA			
Rated voltage		1000 V	1000 V			
Impulse withstand voltage		8000 V				
Protection		IP10	NEMA 1			
Increased safety Ex e		880 V 150 A IEC/EN 60079-7 - IM2 II 2 GD Ex eb I/II/III C				

The connecting capacity data for one Rigid: Solid/Stranded, or one Flexible conductor (when applicable) is a mandatory information required by IEC, UL and CSA standards (Copper conductors). All other data are provided as supplementary information only. For more details, please consult our CB, UL or CSA certificates and technical datasheet available on <http://www.TE.com>



Accessories



Description	Color	Type	Part Number	Pkg qty	Weight (1 pce) g
1 End stops	Dark grey	BAZH1	1SNK900102R0000	20	24.00
2 Jumper bars	Orange	JB16-2	1SNK916302R0000	10	10.00
		JB16-3	1SNK916303R0000	10	16.00
		JB16-4	1SNK916304R0000	10	22.00
		JB16-5	1SNK916305R0000	10	28.00
		JB16-10	1SNK916310R0000	10	56.60
		3 Terminal block markers	White	MG-CPM 13 41791	1SNB041791R0612
MC812	1SNK160000R0000			22	10.00
MC812PA	1SNK169999R0000			20	14.00
Universal wire markers holder	Grey		UMH	1SNK900611R0000	10

Complete list of accessories is indicated in the terminal block datasheet including end stops. Some accessories such as jumper bars may modify the terminal block's ratings: Complete information available in the accessories section of the catalog.

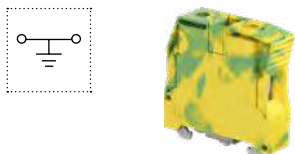

Ground screw clamp terminal blocks

Description	Color	Type	Part Number	Pkg qty	Weight (1 pce) g
Ground Profile aligned with ZS50	Green-yellow	ZS50-PE	1SNK516151R0000	20	83.00

Technical data valid for copper conductors only.

ZS70 screw clamp terminal blocks

Feed-through - 22 mm 0.866 in spacing



ZS70

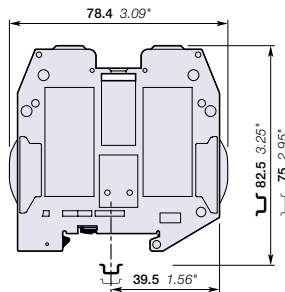

22 mm 0.866 in spacing

Description

Closed terminal block:

- No end section needed,
- Optimized rigidity,
- Perfectly adapted to solar applications: 1250 V DC (1000 V AC) IEC and 1000 V UL.

Ordering details

Description	Color	Type	Part Number	Pkg qty	Weight (1 pce) g
Feed-through Closed block	Grey	ZS70	1SNK522010R0000	10	158.10
	Blue	ZS70-BL	1SNK522020R0000	10	158.10
	Yellow	ZS70-YL	1SNK522060R0000	10	158.10

Main technical data

Connecting capacity		IEC	UL - CSA	Mounting instructions	
1 conductor per clamp	Rigid: Solid/Stranded	16 ... 95 mm ²	4 ... 00 AWG	Rail	TH 35-7.5, TH 35-15
	Flexible without ferrule	16 ... 70 mm ²		Wire stripping length	25 mm 0.984 in
	Flexible with non insulated ferrule	16 ... 50 mm ²			
	Flexible with insulated ferrule	16 ... 50 mm ²			
	Gauge	B11			
2 conductors per clamp	Rigid: Solid/Stranded	16 ... 35 mm ²	4 ... 2 AWG	Tool	Allen key Ø 6 mm Ø 0.236 in
	Flexible without ferrule	16 ... 35 mm ²			
	Flexible with twin ferrule	16 mm ²	6 AWG		
Rated current / Rated cross section		192 A / 70 mm ²	159 A / 00 AWG	Torque	6.5 Nm ± 0.5 57.5 lb.in ± 4.43
Rated short-time withstand current (1s)		8400 A			
Short Circuit Current Rating (with specific conditions)			100 kA		
Rated voltage		1000 V	1000 V		
Impulse withstand voltage		8000 V			
Protection		IP10	NEMA 1		

Increased safety Ex e 693 V 192 A IEC/EN 60079-7 - IM2 II 2 GD Ex eb I/II/III - 600 V 159 A UL 60079-7 - Class I, Zone 1, AEx e II, Ex e II U

The connecting capacity data for one Rigid: Solid/Stranded, or one Flexible conductor (when applicable) is a mandatory information required by IEC, UL and CSA standards (Copper conductors). All other data are provided as supplementary information only. For more details, please consult our CB, UL or CSA certificates and technical datasheet available on <http://www.TE.com>



Accessories

Description	Color	Type	Part Number	Pkg qty	Weight (1 pce) g	
1 End stops	Dark grey	BAZH1	1SNK900102R0000	20	24.00	
2 Jumper bars		10 mm 0.394 in	JB22-2	1SNK922302R0000	5	27.00
		2 poles 192 A (IEC)	JB22-3	1SNK922303R0000	5	43.30
		3 poles 192 A (IEC)	JB22-5	1SNK922305R0000	5	76.10
		5 poles 192 A (IEC)	JB22-10	1SNK922310R0000	5	157.40
		10 poles 192 A (IEC)	MG-CPM 13 41791	1SNB041791R0612	1680	0.27
3 Terminal block markers	White	Blank marker	MC812	1SNK160000R0000	22	10.00
		Blank card	MC812PA	1SNK169999R0000	20	14.00
			UMH	1SNK900611R0000	10	0.20
		Universal wire markers holder	Grey			

Complete list of accessories is indicated in the terminal block datasheet including end stops.

Some accessories such as jumper bars may modify the terminal block's ratings: Complete information available in the accessories section of the catalog.

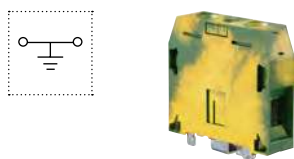

Ground screw clamp terminal blocks

Description	Color	Type	Part Number	Pkg qty	Weight (1 pce) g
Ground	Green-yellow	ZS70-PE	1SNK522150R0000	10	222.00

Technical data valid for copper conductors only.

ZS95 screw clamp terminal blocks

Feed-through - 26 mm 1.024 in spacing

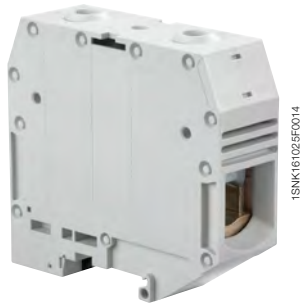

ZS95

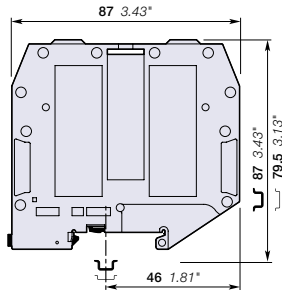

26 mm 1.024 in spacing

Description

Closed terminal block:

- No end section needed,
- Optimized rigidity,
- Perfectly adapted to solar applications: 1250 V DC (1000 V AC) IEC and 1000 V UL.

Ordering details

Description	Color	Type	Part Number	Pkg qty	Weight (1 pce) g
Feed-through Closed block	Grey <input type="checkbox"/>	ZS95	1SNK526010R0000	10	215.10
	Blue <input type="checkbox"/>	ZS95-BL	1SNK526020R0000	10	215.10
	Yellow <input type="checkbox"/>	ZS95-YL	1SNK526060R0000	10	215.10

Main technical data

Connecting capacity		IEC	UL - CSA	Mounting instructions	
1 conductor per clamp	Rigid: Solid/Stranded	35 ... 120 mm ²	2 ... 0000 AWG	Rail	TH 35-7.5, TH 35-15
	Flexible without ferrule	35 ... 95 mm ²		Wire stripping length	26 mm 1.024 in
	Flexible with non insulated ferrule	35 ... 50 mm ²			
	Flexible with insulated ferrule	35 ... 50 mm ²			
	Gauge	B12			
2 conductors per clamp	Rigid: Solid/Stranded	25 ... 35 mm ²	4 ... 2 AWG	Tool	Allen key Ø 6 mm Ø 0.236 in
	Flexible without ferrule	25 ... 35 mm ²			
	Flexible with twin ferrule	16 mm ²	6 AWG		
Rated current / Rated cross section		232 A / 95 mm ²	230 A / 0000 AWG	Torque	9.25 Nm ± 0.25 81.7 lb.in ± 2.21
Rated short-time withstand current (1s)		11400 A			
Short Circuit Current Rating (with specific conditions)			100 kA		
Rated voltage		1000 V	1000 V		
Impulse withstand voltage		8000 V			
Protection		IP10	NEMA 1		
Increased safety Ex e		693 V 232 A IEC/EN 60079-7 - IM2 II 2 GD Ex eb I/II/III C - 600 V 230 A UL 60079-7 - Class I, Zone 1, AEx e II			

The connecting capacity data for one Rigid: Solid/Stranded, or one Flexible conductor (when applicable) is a mandatory information required by IEC, UL and CSA standards (Copper conductors). All other data are provided as supplementary information only. For more details, please consult our CB, UL or CSA certificates and technical datasheet available on <http://www.TE.com>



Accessories

Description	Color	Type	Part Number	Pkg qty	Weight (1 pce) g	
1 End stops	Dark grey <input type="checkbox"/>	BAZH1	1SNK900102R0000	20	24.00	
2 Jumper bars		2 poles 232 A (IEC)	JB26-2	1SNK926302R0000	5	41.20
		3 poles 232 A (IEC)	JB26-3	1SNK926303R0000	5	65.70
		5 poles 232 A (IEC)	JB26-5	1SNK926305R0000	5	115.70
		10 poles 232 A (IEC)	JB26-10	1SNK926310R0000	5	241.50
		Blank marker	White <input type="checkbox"/>	MG-CPM 13 41791	1SNB041791R0612	1680
3 Terminal block markers		Blank card	MC812	1SNK160000R0000	22	10.00
			MC812PA	1SNK169999R0000	20	14.00
		Universal wire markers holder	Grey <input type="checkbox"/>	UMH	1SNK900611R0000	10

Complete list of accessories is indicated in the terminal block datasheet including end stops.

Some accessories such as jumper bars may modify the terminal block's ratings: Complete information available in the accessories section of the catalog.

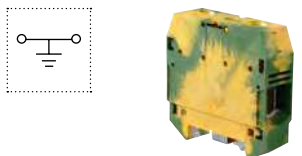

Ground screw clamp terminal blocks

Description	Color	Type	Part Number	Pkg qty	Weight (1 pce) g
Ground Profile aligned with ZS95	Green-yellow <input type="checkbox"/>	ZS95-PE	1SNK526150R0000	10	278.00

Technical data valid for copper conductors only.

ZS150 screw clamp terminal blocks

Feed-through - 31 mm 1.220 in spacing



ZS150

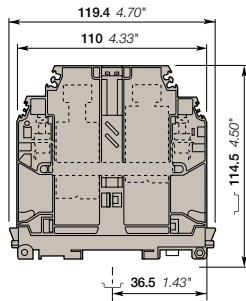

31 mm 1.220 in spacing

Description

- Perfectly adapted to solar applications : 1500V DC (1000V AC) IEC and 1000V UL,
- Closed terminal block: no end section needed, optimized rigidity,
- Ease your voltage monitoring or distribution with the 2 built-in derivations,
- Use of jumper bars requires the user to cut-out the partition.

Ordering details

Description	Color	Type	Part Number	Pkg qty	Weight (1 pce) g
Feed-through Closed block with 2 x 10 mm ² derivations.	Grey <input type="checkbox"/>	ZS150	1SNK531010R0000	5	318.00
	Blue <input type="checkbox"/>	ZS150-BL	1SNK531020R0000	5	318.00
	Yellow <input type="checkbox"/>	ZS150-YL	1SNK531060R0000	5	318.00

Main technical data

Connecting capacity	IEC	UL	CSA	Mounting instructions	
Main circuit with 1 conductor per clamp	Rigid: Solid/Stranded Flexible without ferrule Flexible with insulated ferrule Gauge	35 ... 185 mm ² 50 ... 150 mm ² B14	2 ... 350 Kcmil	2 ... 350 Kcmil	Rail TH 35-7.5, TH 35-15 Wire stripping length 40 mm 1.575 in Tool Allen key Ø 8 mm Ø 0.315 in Torque 20 Nm 177 lb.in
Derivation with 1 conductor per clamp	Rigid: Solid/Stranded Flexible without ferrule Gauge	0.5 ... 16 mm ² 0.5 ... 10 mm ² B6	20 ... 8 AWG	20 ... 8 AWG 20 ... 8 Kcmil	Derivation Wire stripping length 12 mm 0.47 in Tool Flat screwdriver Ø 4 mm Ø 0.157 in Torque 1.2 Nm ... 1.4 Nm 10.6 lb.in ... 12.3 lb.in
Rated current / Rated cross section	Main circuit Copper Aluminium	309 A / 150 mm ²	310 A / 350 Kcmil	310 A / 350 Kcmil	
Rated short-time withstand current (1s)	Derivation	57 A / 10 mm ²	50 A / 8 AWG	50 A / 8 AWG	
Rated voltage	V AC V DC	1000 V 1500	1000 V	1000 V	
Impulse withstand voltage		12000 V			
Protection		IP10	NEMA 1		
Increased safety Ex e		1000 V 309 A IEC/EN 60079-7 - IM2 II 2 GD Ex eb I/II/IIIc			

The connecting capacity data for one Rigid: Solid/Stranded, or one Flexible conductor (when applicable) is a mandatory information required by IEC, UL and CSA standards (Copper conductors). All other data are provided as supplementary information only. For more details, please consult our CB, UL or CSA certificates and technical datasheet available on <http://www.TE.com>



Accessories

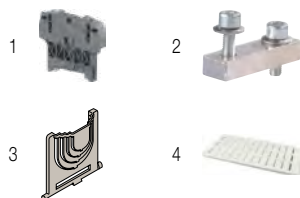

Description	Color	Type	Part Number	Pkg qty	Weight (1 pce) g	
1 End stops	Dark grey <input type="checkbox"/>	BAZH1	1SNK900102R0000	20	24.00	
2 Jumper bars		BJMI31.2	1SNA206053R0700	1	120.00	
		BJMI31.3	1SNA206054R0000	1	190.00	
3 Protecting covers		CPBP1	1SNA399788R1600	20	0.40	
4 Terminal block markers		RC1010	1SNA238000R1600	10	1.30	
		MG-CPM 13 41791	1SNB041791R0612	1680	0.27	
		MC812	1SNK160000R0000	22	10.00	
		MC812PA	1SNK169999R0000	20	14.00	
	Universal wire markers holder	Grey <input type="checkbox"/>	UMH	1SNK900611R0000	10	0.20

Complete list of accessories is indicated in the terminal block datasheet including end stops.

Some accessories such as jumper bars may modify the terminal block's ratings: Complete information available in the accessories section of the catalog.

Technical data valid for copper conductors only.

ZS240 screw clamp terminal blocks

Feed-through - 36 mm 1.417 in spacing

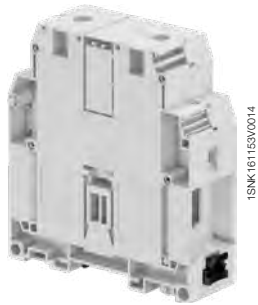

ZS240

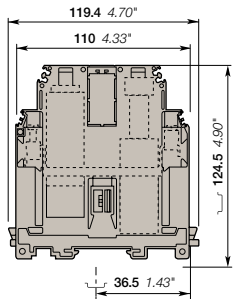

36 mm 1.417 in spacing

Description

- Perfectly adapted to solar applications : 1500V DC (1000V AC) IEC and 1000V UL,
- UL Certified for aluminum cables use - Closed terminal block: no end section needed, optimized rigidity,
- Ease your voltage monitoring or distribution with the 2 built-in derivations,
- Use of jumper bars requires the user to cut-out the partition.

Ordering details

Description	Color	Type	Part Number	Pkg qty	Weight (1 pce)
Feed-through Closed block with 2 x 10 mm ² derivations.	Grey <input type="checkbox"/>	ZS240	1SNK536010R0000	5	366.00
	Blue <input type="checkbox"/>	ZS240-BL	1SNK536020R0000	5	366.00
	Yellow <input type="checkbox"/>	ZS240-YL	1SNK536060R0000	5	366.00

Main technical data

Connecting capacity		IEC	UL	CSA	Mounting instructions		
					Rail		
Main circuit with 1 conductor per clamp	Rigid: Solid/Stranded	50 ... 300 mm ²	0 ... 500 Kcmil	0 ... 500 Kcmil	Main circuit		
	Flexible without ferrule	50 ... 240 mm ²				Wire stripping length	38 mm 1.496 in
	Flexible with insulated ferrule					Tool	Allen key Ø 8 mm Ø 0.315 in
Derivation with 1 conductor per clamp	Rigid: Solid/Stranded	0.5 ... 16 mm ²	20 ... 8 AWG	20 ... 8 AWG	Torque		
	Flexible without ferrule	0.5 ... 10 mm ²	20 ... 8 Kcmil	20 ... 8 Kcmil			25 Nm 221.3 lb.in
	Gauge	B14					
Rated current / Rated cross section					Derivation		
Main circuit	Copper	415 A / 240 mm ²	380 A / 500 Kcmil	380 A / 500 Kcmil		Wire stripping length	12 mm 0.47 in
	Aluminium		271 / 500 Kcmil	271 / 500 Kcmil		Tool	Flat screwdriver Ø 4 mm Ø 0.157 in
Derivation		57 A / 10 mm ²	50 A / 8 AWG	50 A / 8 AWG	Torque		
Rated short-time withstand current (1s)		28800 A					1.2 Nm ... 1.4 Nm 10.6 lb.in ... 12.3 lb.in
Rated voltage							
V AC		1000 V	1000 V	1000 V			
V DC		1500					
Impulse withstand voltage		12000 V					
Protection		IP10	NEMA 1				
Increased safety Ex e		1000 V 415 A IEC/EN 60079-7 - IM2 II 2 GD Ex eb I/II/III					

The connecting capacity data for one Rigid: Solid/Stranded, or one Flexible conductor (when applicable) is a mandatory information required by IEC, UL and CSA standards (Copper conductors). All other data are provided as supplementary information only. For more details, please consult our CB, UL or CSA certificates and technical datasheet available on <http://www.TE.com>



Accessories

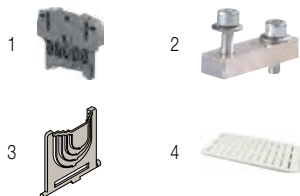

Description	Color	Type	Part Number	Pkg qty	Weight (1 pce)	
1 End stops	Dark grey <input type="checkbox"/>	BAZH1	1SNK900102R0000	20	24.00	
2 Jumper bars		2 poles	BJMI36.2	1SNA206126R2500	1	170.00
		3 poles	BJMI36.3	1SNA206223R0600	1	260.00
3 Protecting covers		CPBP2	1SNA399787R0500	20	1.30	
4 Terminal block markers	White <input type="checkbox"/>	Blank card	RC1010	1SNA238000R1600	10	1.30
		Blank marker	MG-CPM 13 41791	1SNB041791R0612	1680	0.27
		Blank card	MC812	1SNK160000R0000	22	10.00
			MC812PA	1SNK169999R0000	20	14.00
		Universal wire markers holder	Grey <input type="checkbox"/>	UMH	1SNK900611R0000	10

Complete list of accessories is indicated in the terminal block datasheet including end stops.

Some accessories such as jumper bars may modify the terminal block's ratings: Complete information available in the accessories section of the catalog.

Technical data valid for copper conductors only.

ZS4-PE screw clamp terminal blocks

Ground - 5.2 mm 0.205 in spacing

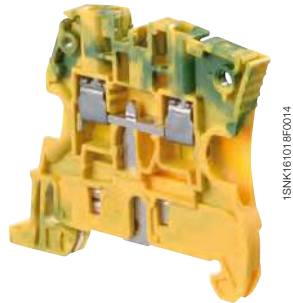

ZS4-PE

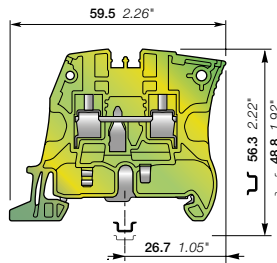

5.2 mm 0.205 in spacing

Description

Improve the safety of your installation in the event of a short-circuit thanks to our screwless rail contact:

- Rail contact non operator dependent,
- Performances above the requirements of IEC 60947-7-2 terminal block standard,
- Secured snap on or remove from the rail.

Ordering details

Description	Color	Type	Part Number	Pkg qty	Weight (1 pce) g
Ground Screwless rail connection	Green-yellow	ZS4-PE	1SNK505150R0000	20	12.10

Main technical data

Connecting capacity		IEC	UL - CSA	Mounting instructions	
1 conductor per clamp	Rigid: Solid/Stranded	0.2 ... 4 mm ²	24 ... 12 AWG	Rail	TH 35-7.5, TH 35-15
	Flexible without ferrule	0.22 ... 4 mm ²		Wire stripping length	10.5 mm 0.412 in
	Flexible with non insulated ferrule	0.22 ... 4 mm ²	24 ... 12 AWG		
	Flexible with insulated ferrule	0.22 ... 2.5 mm ²	24 ... 14 AWG		
	Gauge	A3-B3		Tool	Flat screwdriver Ø 3.5 mm Ø 0.138 in
Rated cross section		4 mm ²	12 AWG	Torque	0.6 Nm ± 0.1 5.31 lb.in ± 0.885
Rated short-time withstand current (1s)		480 A	396 A		
Protection		IP20	NEMA 1		
Explosive atmosphere classification		IM2 II 2 GD Ex eb I/IIIC - Class I, Zone 1, AEx e II, Ex e II U			

The connecting capacity data for one Rigid: Solid/Stranded, or one Flexible conductor (when applicable) is a mandatory information required by IEC, UL and CSA standards (Copper conductors). All other data are provided as supplementary information only. For more details, please consult our CB, UL or CSA certificates and technical datasheet available on <http://www.TE.com>

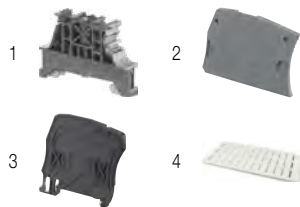

Accessories

Description	Color	Type	Part Number	Pkg qty	Weight (1 pce) g
1 End stops 10 mm 0.394 in	Dark grey	BAM4	1SNK900001R0000	50	14.00
2 End sections 2.2 mm 0.087 in	Dark grey	ES4	1SNK505910R0000	20	2.20
3 Circuit separators 3 mm 0.118 in	Dark grey	CS-R1	1SNK900103R0000	20	5.20
4 Terminal block markers	White	MG-CPM 13 41790	1SNB041790R0512	1960	0.23
		MC512	1SNK140000R0000	22	9.00
		MC512PA	1SNK149999R0000	20	10.00
Universal wire markers holder	Grey	UMH	1SNK900611R0000	10	0.20

Complete list of accessories is indicated in the terminal block datasheet including end stops. Some accessories such as jumper bars may modify the terminal block's ratings: Complete information available in the accessories section of the catalog.

Technical data valid for copper conductors only.

ZS6-PE screw clamp terminal blocks

Ground - 6 mm 0.236 in spacing

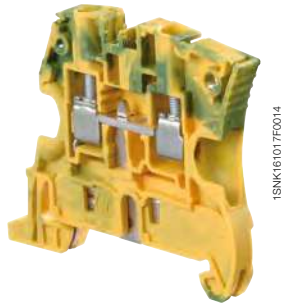

1SNK161017F0014

ZS6-PE

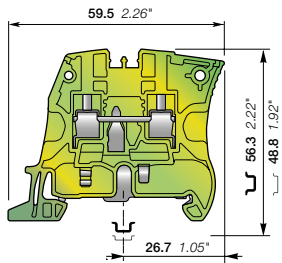

6 mm 0.236 in spacing

Description

Improve the safety of your installation in the event of a short-circuit thanks to our screwless rail contact:

- Rail contact non operator dependent,
- Performances above the requirements of IEC 60947-7-2 terminal block standard,
- Secured snap on or remove from the rail.

Ordering details

Description	Color	Type	Part Number	Pkg qty	Weight (1 pce)
Ground Screwless rail connection	Green-yellow	ZS6-PE	1SNK506150R0000	20	13.70

Main technical data

Connecting capacity		IEC	UL - CSA	Mounting instructions	
1 conductor per clamp	Rigid: Solid/Stranded	0.2 ... 6 mm ²	24 ... 10 AWG	Rail	TH 35-7.5, TH 35-15
	Flexible without ferrule	0.2 ... 6 mm ²		Wire stripping length	10.5 mm 0.412 in
	Flexible with non insulated ferrule	0.22 ... 4 mm ²	24 ... 12 AWG		
	Flexible with insulated ferrule	0.22 ... 4 mm ²	24 ... 12 AWG		
	Gauge	A4-B3		Tool	Flat screwdriver Ø 4 mm Ø 0.157 in
Rated cross section		6 mm ²	10 AWG	Torque	0.85 Nm ± 0.15 7.52 lb.in ± 1.33
Rated short-time withstand current (1s)		720 A	636 A		
Protection		IP20	NEMA 1		
Explosive atmosphere classification		IM2 II 2 GD Ex eb III/IIIC - Class I, Zone 1, AEx e II, Ex e II U			

The connecting capacity data for one Rigid: Solid/Stranded, or one Flexible conductor (when applicable) is a mandatory information required by IEC, UL and CSA standards (Copper conductors). All other data are provided as supplementary information only. For more details, please consult our CB, UL or CSA certificates and technical datasheet available on <http://www.TE.com>



Accessories

Description	Color	Type	Part Number	Pkg qty	Weight (1 pce)
1 End stops 10 mm 0.394 in	Dark grey	BAM4	1SNK900001R0000	50	14.00
2 End sections 2.2 mm 0.087 in	Dark grey	ES4	1SNK505910R0000	20	2.20
3 Circuit separators 3 mm 0.118 in	Dark grey	CS-R1	1SNK900103R0000	20	5.20
4 Terminal block markers	White	MG-CPM 13 41791	1SNB041791R0612	1680	0.27
		MC612	1SNK150000R0000	22	10.00
		MC612PA	1SNK159999R0000	20	11.00
Universal wire markers holder	Grey	UMH	1SNK900611R0000	10	0.20

Complete list of accessories is indicated in the terminal block datasheet including end stops. Some accessories such as jumper bars may modify the terminal block's ratings: Complete information available in the accessories section of the catalog.

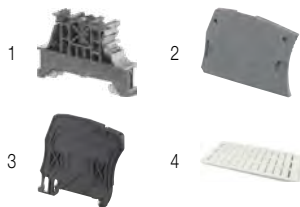

Technical data valid for copper conductors only.

ZS6-3S-PE screw clamp terminal blocks

Ground with 3 connections - 6 mm 0.236 in spacing



6 mm²
10 AWG



ZS6-3S-PE

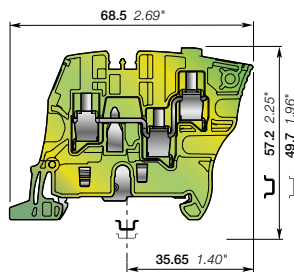

6 mm 0.236 in spacing

Description

Improve the safety of your installation in the event of a short-circuit thanks to our screwless rail contact:

- rail contact non operator dependent, secured snap on or off the rail,
- Same profile as ZS6-3S for aligned marking and identical end section.

Ordering details

Description	Color	Type	Part Number	Pkg qty	Weight (1 pce) g
Ground Screwless rail connection	Green-yellow	ZS6-3S-PE	1SNK506151R0000	25	16.20

Main technical data

Connecting capacity		IEC	UL - CSA	Mounting instructions	
1 conductor per clamp	Rigid: Solid/Stranded	0.2 ... 6 mm ²	24 ... 10 AWG	Rail	TH 35-7.5, TH 35-15
	Flexible without ferrule	0.22 ... 6 mm ²		Wire stripping length	10.5 mm 0.413 in
	Flexible with non insulated ferrule	0.22 ... 4 mm ²	24 ... 12 AWG		
	Flexible with insulated ferrule	0.22 ... 4 mm ²	24 ... 12 AWG		
Gauge		A4-B3		Tool	Flat screwdriver Ø 4 mm Ø 0.157 in
Rated cross section		4 mm ²	10 AWG	Torque	0.75 Nm ± 0.05 6.64 lb.in ± 0.443
Maximum cross section		6 mm ²			
Rated short-time withstand current (1s)		480 A	636 A		
Maximum short-time withstand current (1s)		480 A		Protection	
		IP20	NEMA 1	Explosive atmosphere classification	
		IM2 II 2 GD Ex eb I/IIIC - Class I, Zone 1, AEx e II			

The connecting capacity data for one Rigid: Solid/Stranded, or one Flexible conductor (when applicable) is a mandatory information required by IEC, UL and CSA standards (Copper conductors). All other data are provided as supplementary information only. For more details, please consult our CB, UL or CSA certificates and technical datasheet available on <http://www.TE.com>



Accessories

Description	Color	Type	Part Number	Pkg qty	Weight (1 pce) g
1 End stops	Dark grey	BAM4	1SNK900001R0000	50	14.00
2 End sections	Dark grey	ES6-3S	1SNK505912R0000	20	2.50
3 Circuit separators	Dark grey	CS-R1	1SNK900103R0000	20	5.20
4 Terminal block markers	White	MG-CPM 13 41791	1SNB041791R0612	1680	0.27
		MC612	1SNK150000R0000	22	10.00
		MC612PA	1SNK159999R0000	20	11.00
Universal wire markers holder	Grey	UMH	1SNK900611R0000	10	0.20

Complete list of accessories is indicated in the terminal block datasheet including end stops. Some accessories such as jumper bars may modify the terminal block's ratings: Complete information available in the accessories section of the catalog.

Technical data valid for copper conductors only.

ZS6-4S-PE screw clamp terminal blocks

Ground with 4 connections - 6 mm 0.236 in spacing

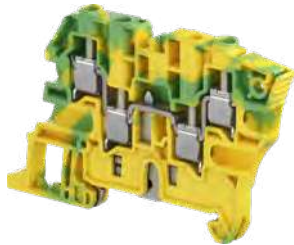

ZS6-4S-PE

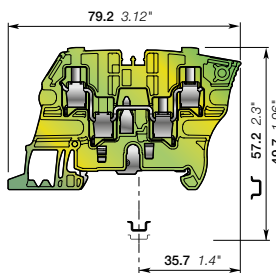

6 mm 0.236 in spacing

Description

Improve the safety of your installation in the event of a short-circuit thanks to our screwless rail contact:

- rail contact non operator dependent, secured snap on or off the rail,
- Same profile as ZS6-4S for aligned marking and identical end section.

Ordering details

Description	Color	Type	Part Number	Pkg qty	Weight (1 pce) g
Ground Screwless rail connection	Green-yellow	ZS6-4S-PE	1SNK506152R0000	25	19.40

Main technical data

Connecting capacity		IEC	UL - CSA	Mounting instructions	
1 conductor per clamp	Rigid: Solid/Stranded	0.2 ... 6 mm ²	24 ... 10 AWG	Rail	TH 35-7.5, TH 35-15
	Flexible without ferrule	0.22... 6 mm ²		Wire stripping length	10.5 mm 0.413 in
	Flexible with non insulated ferrule	0.22 ... 4 mm ²	24 ... 12 AWG	Tool	Flat screwdriver Ø 4 mm Ø 0.157 in
	Flexible with insulated ferrule	0.22 ... 4 mm ²	24 ... 12 AWG		
	Gauge	A4-B3		Torque	0.75 Nm ± 0.05 6.64 lb.in ± 0.443
Rated cross section		4 mm ²	10 AWG		
Maximum cross section		6 mm ²			
Rated short-time withstand current (1s)		480 A	636 A		
Maximum short-time withstand current (1s)		480 A			
Protection		IP20	NEMA 1		
Explosive atmosphere classification		IM2 II 2 GD Ex eb I/IIIC - Class I, Zone 1, AEx e II			

The connecting capacity data for one Rigid: Solid/Stranded, or one Flexible conductor (when applicable) is a mandatory information required by IEC, UL and CSA standards (Copper conductors). All other data are provided as supplementary information only. For more details, please consult our CB, UL or CSA certificates and technical datasheet available on <http://www.TE.com>



Accessories

Description	Color	Type	Part Number	Pkg qty	Weight (1 pce) g
1 End stops 10 mm 0.394 in	Dark grey	BAM4	1SNK900001R0000	50	14.00
2 End sections 2.2 mm 0.087 in	Dark grey	ES6-4S	1SNK505911R0000	20	3.10
3 Circuit separators 3 mm 0.118 in	Dark grey	CS-R1	1SNK900103R0000	20	5.20
4 Terminal block markers	White	MG-CPM 13 41791	1SNB041791R0612	1680	0.27
		MC612	1SNK150000R0000	22	10.00
		MC612PA	1SNK159999R0000	20	11.00
Universal wire markers holder	Grey	UMH	1SNK900611R0000	10	0.20

Complete list of accessories is indicated in the terminal block datasheet including end stops. Some accessories such as jumper bars may modify the terminal block's ratings. Complete information available in the accessories section of the catalog.

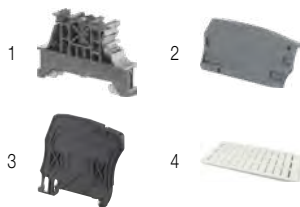

Technical data valid for copper conductors only.

ZS10-PE screw clamp terminal blocks

Ground - 8 mm 0.315 in spacing

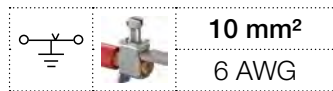

ZS10-PE

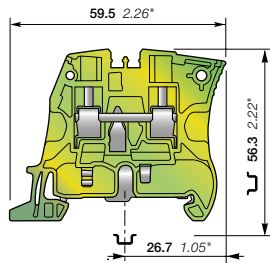

8 mm 0.315 in spacing

Description

Improve the safety of your installation in the event of a short-circuit thanks to our screwless rail contact:

- Rail contact non operator dependent,
- Performances above the requirements of IEC 60947-7-2 terminal block standard,
- Secured snap on or remove from the rail.

Ordering details

Description	Color	Type	Part Number	Pkg qty	Weight (1 pce) g
Ground Screwless rail connection	Green-yellow	ZS10-PE	1SNK508150R0000	20	22.50

Main technical data

Connecting capacity		IEC	UL - CSA	Mounting instructions	
1 conductor per clamp	Rigid: Solid/Stranded	0.5 ... 10 mm ²	24 ... 6 AWG	Rail	TH 35-7.5, TH 35-15
	Flexible without ferrule	0.5 ... 10 mm ²		Wire stripping length	12 mm 0.472 in
	Flexible with non insulated ferrule	0.5 ... 10 mm ²	24 ... 8 AWG		
	Flexible with insulated ferrule	0.5 ... 6 mm ²	24 ... 8 AWG		
	Gauge	A5-B5		Tool	Flat screwdriver Ø 4 mm Ø 0.157 in
Rated cross section		10 mm ²	6 AWG	Torque	1.3 Nm ± 0.3 11.5 lb.in ± 2.65
Rated short-time withstand current (1s)		1200 A	1596 A		
Protection		IP20	NEMA 1		
Explosive atmosphere classification		IM2 II 2 GD Ex eb I/IIIC - Class I, Zone 1, AEx e II, Ex e II U			

The connecting capacity data for one Rigid: Solid/Stranded, or one Flexible conductor (when applicable) is a mandatory information required by IEC, UL and CSA standards (Copper conductors). All other data are provided as supplementary information only. For more details, please consult our CB, UL or CSA certificates and technical datasheet available on <http://www.TE.com>



Accessories

Description	Color	Type	Part Number	Pkg qty	Weight (1 pce) g
1 End stops	Dark grey	BAM4	1SNK900001R0000	50	14.00
2 End sections	Dark grey	ES4	1SNK505910R0000	20	2.20
3 Circuit separators	Dark grey	CS-R1	1SNK900103R0000	20	5.20
4 Terminal block markers	White	MG-CPM 13 41791	1SNB041791R0612	1680	0.27
		MC812	1SNK160000R0000	22	10.00
		MC812PA	1SNK169999R0000	20	14.00
Universal wire markers holder	Grey	UMH	1SNK900611R0000	10	0.20

Complete list of accessories is indicated in the terminal block datasheet including end stops. Some accessories such as jumper bars may modify the terminal block's ratings: Complete information available in the accessories section of the catalog.



Technical data valid for copper conductors only.

ZS16-PE screw clamp terminal blocks

Ground - 10 mm 0.394 in spacing

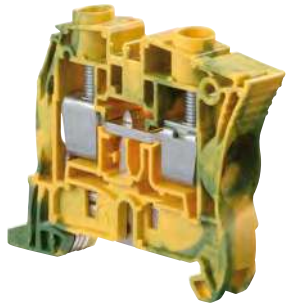

1SNK161019F0014

ZS16-PE

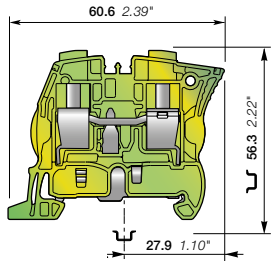

10 mm 0.394 in spacing

Description

- Improve the safety of your installation in the event of a short-circuit thanks to our screwless rail contact:
- Rail contact non operator dependent,
 - Performances above the requirements of IEC 60947-7-2 terminal block standard,
 - Secured snap on or remove from the rail,
 - PE.N function available by combining ZS16-PE with ZS16-BL and 2 poles jumper bar JB10-2.

Ordering details

Description	Color	Type	Part Number	Pkg qty	Weight (1 pce)
Ground Screwless rail connection	Green-yellow	ZS16-PE	1SNK510150R0000	20	32.00

Main technical data

Connecting capacity	IEC	UL - CSA	Mounting instructions	
1 conductor per clamp Rigid: Solid/Stranded Flexible without ferrule Flexible with non insulated ferrule Flexible with insulated ferrule Gauge	0.5 ... 16 mm ²	24 ... 4 AWG	Rail	TH 35-7.5, TH 35-15
	0.5 ... 16 mm ²	24 ... 4 AWG	Wire stripping length	13.5 mm 0.531 in
	0.5 ... 16 mm ²	24 ... 4 AWG	Tool	Flat screwdriver Ø 5.5 mm Ø 0.217 in
	0.5 ... 10 mm ²	24 ... 8 AWG		
	A6-B6		Torque	1.8 Nm ± 0.2 15.9 lb.in ± 1.77
Rated cross section	16 mm ²	4 AWG		
Rated short-time withstand current (1s)	1920 A	2544 A		
Protection	IP20	NEMA 1		
Explosive atmosphere classification	IM2 II 2 GD Ex eb III/IIIC - Class I, Zone 1, AEx e II, Ex e II U			

The connecting capacity data for one Rigid: Solid/Stranded, or one Flexible conductor (when applicable) is a mandatory information required by IEC, UL and CSA standards (Copper conductors). All other data are provided as supplementary information only. For more details, please consult our CB, UL or CSA certificates and technical datasheet available on <http://www.TE.com>



Accessories

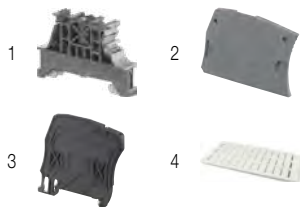

Description	Color	Type	Part Number	Pkg qty	Weight (1 pce)
1 End stops 10 mm 0.394 in	Dark grey	BAM4	1SNK900001R0000	50	14.00
2 End sections 2.2 mm 0.087 in	Dark grey	ES4	1SNK505910R0000	20	2.20
3 Circuit separators 3 mm 0.118 in	Dark grey	CS-R1	1SNK900103R0000	20	5.20
4 Terminal block markers	White	MG-CPM 13 41791	1SNB041791R0612	1680	0.27
		MC812	1SNK160000R0000	22	10.00
		MC812PA	1SNK169999R0000	20	14.00
Universal wire markers holder	Grey	UMH	1SNK900611R0000	10	0.20

Complete list of accessories is indicated in the terminal block datasheet including end stops. Some accessories such as jumper bars may modify the terminal block's ratings: Complete information available in the accessories section of the catalog.

Technical data valid for copper conductors only.

ZS25-PE screw clamp terminal blocks

Ground - 12 mm 0.472 in spacing



25 mm²
3 AWG



1SNK161092V0014

ZS25-PE

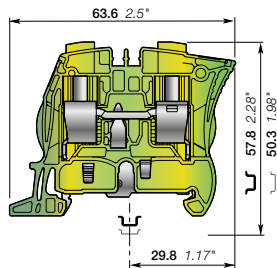

12 mm 0.472 in spacing

Description

Improve the safety of your installation in the event of a short-circuit thanks to our screwless rail contact:

- rail contact non operator dependent, secured snap on or off the rail,
- Same profile as ZS25 for aligned marking and identical end section.

Ordering details

Description	Color	Type	Part Number	Pkg qty	Weight (1 pce) g
Ground Screwless rail connection	Green-yellow	ZS25-PE	1SNK512150R0000	20	38.00

Main technical data

Connecting capacity		IEC	UL - CSA	Mounting instructions	
1 conductor per clamp	Rigid: Solid/Stranded	0.5 ... 25 mm ²	24 ... 3 AWG	Rail	TH 35-7.5, TH 35-15
	Flexible without ferrule	0.5 ... 25 mm ²		Wire stripping length	13.5 mm 0.531 in
	Flexible with non insulated ferrule	0.5 ... 16 mm ²	24 ... 4 AWG		
	Flexible with insulated ferrule	0.5 ... 16 mm ²	24 ... 8 AWG		
Gauge		A6-B6		Tool	Flat screwdriver Ø 5.5 mm Ø 0.217 in
Rated cross section		16 mm ²	3 AWG	Torque	1.8 Nm ± 0.2 15.9 lb.in ± 1.77
Maximum cross section		25 mm ²			
Rated short-time withstand current (1s)		1920 A	3204 A		
Maximum short-time withstand current (1s)		3000 A			
Protection		IP20	NEMA 1		

Explosive atmosphere classification

IM2 II 2 GD Ex eb I/IIIC - Class I, Zone 1, AEx e II, Ex e II U

The connecting capacity data for one Rigid: Solid/Stranded, or one Flexible conductor (when applicable) is a mandatory information required by IEC, UL and CSA standards (Copper conductors). All other data are provided as supplementary information only. For more details, please consult our CB, UL or CSA certificates and technical datasheet available on <http://www.TE.com>



Accessories

Description	Color	Type	Part Number	Pkg qty	Weight (1 pce) g
1 End stops	Dark grey	BAM4	1SNK900001R0000	50	14.00
2 End sections	Dark grey	ES4	1SNK505910R0000	20	2.20
3 Circuit separators	Dark grey	CS-R1	1SNK900103R0000	20	5.20
4 Terminal block markers	White	MG-CPM 13 41791	1SNB041791R0612	1680	0.27
		MC812	1SNK160000R0000	22	10.00
		MC812PA	1SNK169999R0000	20	14.00
Universal wire markers holder	Grey	UMH	1SNK900611R0000	10	0.20

Complete list of accessories is indicated in the terminal block datasheet including end stops.

Some accessories such as jumper bars may modify the terminal block's ratings: Complete information available in the accessories section of the catalog.

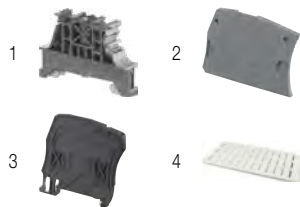

Technical data valid for copper conductors only.

ZS35-PE screw clamp terminal blocks

Ground - 16 mm 0.630 in spacing

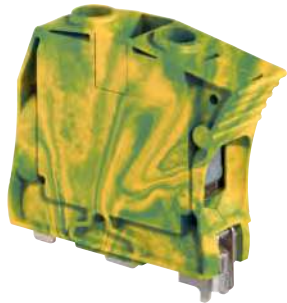

1SNK161005F0014

ZS35-PE

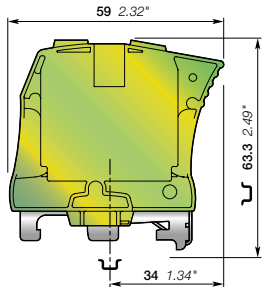

16 mm 0.630 in spacing

Description

Reliable electrical and mechanical contact with the rail that exceeds the requirements of IEC 60947-7-2 terminal block standard.

Ordering details

Description	Color	Type	Part Number	Pkg qty	Weight (1 pce)
Ground Screw rail connection	Green-yellow	ZS35-PE	1SNK516150R0000	20	81.80 g

Main technical data

Connecting capacity		IEC	UL - CSA	Mounting instructions	
1 conductor per clamp	Rigid: Solid/Stranded	6 ... 35 mm ²	10 ... 2 AWG	Rail	TH 35-7.5, TH 35-15
	Flexible without ferrule	6 ... 35 mm ²		Wire stripping length	17 mm 0.669 in
	Flexible with non insulated ferrule	4 ... 35 mm ²	10 ... 2 AWG	Tool	Flat screwdriver Ø 6.5 mm Ø 0.256 in
	Flexible with insulated ferrule	4 ... 35 mm ²	10 ... 2 AWG	Screw clamp	
Gauge		A9		Rail connection screw	Ø 5.5 Ø 0.217
Rated cross section		35 mm ²	2 AWG	Torque	2.65 Nm ± 0.15 23.4 lb.in ± 1.33
Rated short-time withstand current (1s)		4200 A	4032 A	Screw clamp	
Protection		IP10	NEMA 1	Rail connection screw	1.6 Nm ± 0.15 Nm 14.2 lb.in ± 1.33 lb.in
Explosive atmosphere classification		IM2 II 2 GD Ex eb III/IIIC - Class I, Zone 1, AEx e II			

The connecting capacity data for one Rigid: Solid/Stranded, or one Flexible conductor (when applicable) is a mandatory information required by IEC, UL and CSA standards (Copper conductors). All other data are provided as supplementary information only. For more details, please consult our CB, UL or CSA certificates and technical datasheet available on <http://www.TE.com>



Accessories

Description	Color	Type	Part Number	Pkg qty	Weight (1 pce)	
1 End stops 10 mm 0.394 in	Dark grey	BAZH1	1SNK900102R0000	20	24.00	
2 Circuit separators 3 mm 0.118 in	Dark grey	CS-R1	1SNK900103R0000	20	5.20	
3 Terminal block markers	White	Blank marker	MG-CPM 13 41791	1SNB041791R0612	1680	0.27
		Blank card	MC812	1SNK160000R0000	22	10.00
		Universal wire markers holder	MC812PA	1SNK169999R0000	20	14.00
	Grey	UMH	1SNK900611R0000	10	0.20	

Complete list of accessories is indicated in the terminal block datasheet including end stops. Some accessories such as jumper bars may modify the terminal block's ratings: Complete information available in the accessories section of the catalog.

Technical data valid for copper conductors only.

ZS35-PEN screw clamp terminal blocks

Ground + neutral - 32 mm 1.260 in spacing



ZS35-PEN

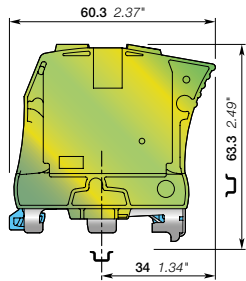

32 mm 1.260 in spacing

Description

Simplify your PE.N connection with ZS35-PE block connected to ZS35-BL through a pre-mounted jumper.

Ordering details

Description	Color	Type	Part Number	Pkg qty	Weight (1 pce) g
Ground + neutral	Green-yellow	ZS35-PEN	1SNK516170R0000	10	236.00

Main technical data

Connecting capacity		IEC	UL - CSA	Mounting instructions	
1 conductor per clamp	Rigid: Solid/Stranded	6 ... 35 mm ²		Rail	TH 35-7.5, TH 35-15
	Flexible without ferrule	6 ... 35 mm ²		Wire stripping length	17 mm 0.669 in
	Flexible with non insulated ferrule	6 ... 35 mm ²	10 ... 2 AWG	Tool	Flat screwdriver
	Flexible with insulated ferrule	6 ... 35 mm ²		Screw clamp	Ø 6.5 mm Ø 0.256 in
	Gauge	A9		Rail connection screw	Ø 5.5 Ø 0.217
Rated cross section		35 mm ²		Torque	2.65 Nm ± 0.15 23.5 lb.in ± 1.33
Rated short-time withstand current (1s)		4200 A		Screw clamp	1.6 Nm ± 0.15 Nm 14.2 lb.in ± 1.33 lb.in
Protection		IP10	NEMA 1	Rail connection screw	

The connecting capacity data for one Rigid: Solid/Stranded, or one Flexible conductor (when applicable) is a mandatory information required by IEC, UL and CSA standards (Copper conductors). All other data are provided as supplementary information only. For more details, please consult our CB, UL or CSA certificates and technical datasheet available on <http://www.TE.com>

CE	RoHS	EAC							
----	------	-----	--	--	--	--	--	--	--



Accessories

Description	Color	Type	Part Number	Pkg qty	Weight (1 pce) g
1 End stops	Dark grey	BAZH1	1SNK900102R0000	20	24.00
2 Terminal block markers	White	MG-CPM 13 41791	1SNB041791R0612	1680	0.27
		MC812	1SNK160000R0000	22	10.00
	Grey	MC812PA	1SNK169999R0000	20	14.00
		UMH	1SNK900611R0000	10	0.20

Complete list of accessories is indicated in the terminal block datasheet including end stops. Some accessories such as jumper bars may modify the terminal block's ratings: Complete information available in the accessories section of the catalog.

Technical data valid for copper conductors only.

ZS50-PE screw clamp terminal blocks

Ground - 16 mm 0.630 in spacing

		50 mm²
		0 AWG





Description

- Reliable electrical and mechanical contact with the rail that exceeds the requirements of the IEC 60947-7-2 terminal block standard.













Ordering details

Description	Color	Type	Part Number	Pkg qty	Weight (1 pce)
Ground Screw rail connection	Green-yellow 	ZS50-PE	1SNK516151R0000	20	83.00

Main technical data

Connecting capacity		IEC	UL - CSA	Mounting instructions	
1 conductor per clamp	Rigid: Solid/Stranded	1 ... 50 mm ²	18 ... 0 AWG	Rail	 TH 35-7.5, TH 35-15
	Flexible without ferrule	1 ... 50 mm ²	18 ... 0 AWG	Wire stripping length	 17 mm 0.669 in
	Flexible with non insulated ferrule	1 ... 50 mm ²	18 ... 0 AWG	Tool	Flat screwdriver
	Flexible with insulated ferrule	1 ... 50 mm ²	18 ... 0 AWG		
	Gauge		Dia. 11	Rail connection screw	 Ø 6.5 Ø 0.256
Rated cross section		50 mm ²	0 AWG	Torque	Screw clamp
Rated short-time withstand current (1s)		6000 A	6420 A		
Protection		IP10	NEMA 1	Rail connection screw	 3 Nm ± 0.25 Nm 26.553 lb.in ± 2.21 lb.in
Explosive atmosphere classification		IM2 II 2 GD Ex eb III/IIIC - Class I, Zone 1, AEx e II			

The connecting capacity data for one Rigid: Solid/Stranded, or one Flexible conductor (when applicable) is a mandatory information required by IEC, UL and CSA standards (Copper conductors). All other data are provided as supplementary information only. For more details, please consult our CB, UL or CSA certificates and technical datasheet available on <http://www.TE.com>

											
CE	CB	RoHS	UL	CSA	EAC Ex	ATEX	IECEX	BR-Ex e II	Haz Loc	BV	DNV



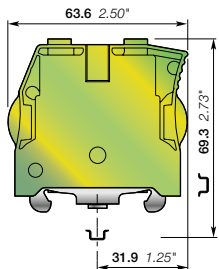

1SNK16103500014

ZS50-PE



16 mm 0.630 in spacing

Accessories

Description	Color	Type	Part Number	Pkg qty	Weight (1 pce)	
1 End stops	Dark grey 	BAZH1	1SNK900102R0000	20	24.00	
2 Terminal block markers	White 	Blank marker	MG-CPM 13 41791	1SNB041791R0612	1680	
		Blank card	MC812	1SNK160000R0000	22	10.00
			MC812PA	1SNK169999R0000	20	14.00
	Universal wire markers holder	Grey 	UMH	1SNK900611R0000	10	0.20

Complete list of accessories is indicated in the terminal block datasheet including end stops. Some accessories such as jumper bars may modify the terminal block's ratings. Complete information available in the accessories section of the catalog.

Technical data valid for copper conductors only.

ZS70-PE screw clamp terminal blocks

Ground - 22 mm 0.866 in spacing









Description

Reliable electrical and mechanical contact with the rail that exceeds the requirements of IEC 60947-7-2 terminal block standard.

Ordering details

Description	Color	Type	Part Number	Pkg qty	Weight (1 pce)
Ground Screw rail connection	Green-yellow	ZS70-PE	1SNK522150R0000	10	222.00 g

Main technical data

Connecting capacity	IEC	UL - CSA	Mounting instructions
1 conductor per clamp			
Rigid: Solid/Stranded	16 ... 95 mm ²	4 ... 00 AWG	Rail  TH 35-15
Flexible without ferrule	16 ... 70 mm ²		Wire stripping length  25 mm / 0.984 in
Flexible with non insulated ferrule	16 ... 50 mm ²		Tool  Allen key
Flexible with insulated ferrule	16 ... 50 mm ²		Screw clamp  Ø 6 mm
Gauge	B11		Rail connection screw  Ø 0.236 in
Rated cross section	70 mm ²	00 AWG	Torque  Screw clamp 6.5 Nm ± 0.5
Rated short-time withstand current (1s)	8400 A	8088 A	Rail connection screw 1.9 Nm ± 0.1 Nm / 16.82 lb.in ± 0.885 lb.in
Protection	IP10	NEMA 1	
Explosive atmosphere classification	IM2 II 2 GD Ex eb I/IIIC - Class I, Zone 1, AEx e II, Ex e II U		

The connecting capacity data for one Rigid: Solid/Stranded, or one Flexible conductor (when applicable) is a mandatory information required by IEC, UL and CSA standards (Copper conductors). All other data are provided as supplementary information only. For more details, please consult our CB, UL or CSA certificates and technical datasheet available on <http://www.TE.com>

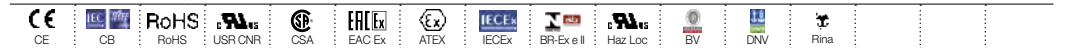

ZS70-PE

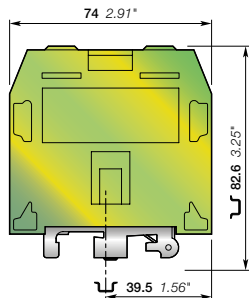

22 mm 0.866 in spacing



Accessories

Description	Color	Type	Part Number	Pkg qty	Weight (1 pce)
1 End stops	Dark grey	BAZH1	1SNK900102R0000	20	24.00 g
2 Terminal block markers	White	MG-CPM 13 41791	1SNB041791R0612	1680	0.27 g
		MC812	1SNK160000R0000	22	10.00 g
		MC812PA	1SNK169999R0000	20	14.00 g
	Universal wire markers holder	Grey	UMH	1SNK900611R0000	10

Complete list of accessories is indicated in the terminal block datasheet including end stops.

Some accessories such as jumper bars may modify the terminal block's ratings: Complete information available in the accessories section of the catalog.

Technical data valid for copper conductors only.

ZS95-PE screw clamp terminal blocks

Ground - 26 mm 1.024 in spacing

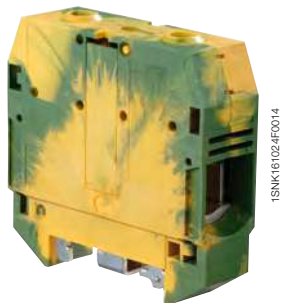

ZS95-PE

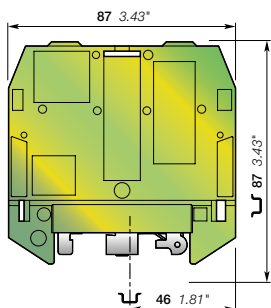

26 mm 1.024 in spacing



Description

Reliable electrical and mechanical contact with the rail that exceeds the requirements of IEC 60947-7-2 terminal block standard.

Ordering details

Description	Color	Type	Part Number	Pkg qty	Weight (1 pce)
Ground Screw rail connection	Green-yellow	ZS95-PE	1SNK526150R0000	10	278.00

Main technical data

Connecting capacity		IEC	UL - CSA	Mounting instructions	
1 conductor per clamp	Rigid: Solid/Stranded	35 ... 120 mm ²	2 ... 0000 AWG	Rail	TH 35-15
	Flexible without ferrule	35 ... 95 mm ²		Wire stripping length	26 mm 1.024 in
	Flexible with non insulated ferrule	35 ... 50 mm ²		Tool	Allen key
	Flexible with insulated ferrule	35 ... 50 mm ²		Screw clamp	Ø 6 mm
	Gauge	B12		Rail connection screw	Ø 0.236 in
Rated cross section		95 mm ²	0000 AWG	Torque	9.25 Nm ± 0.25
Rated short-time withstand current (1s)		11400 A	12840 A	Screw clamp	81.7 lb.in ± 2.2
Protection		IP10	NEMA 1	Rail connection screw	1.9 Nm ± 0.1 Nm
Explosive atmosphere classification		IM2 II 2 GD Ex eb III/IIIC - Class I, Zone 1, AEx e II, Ex e II U			

The connecting capacity data for one Rigid: Solid/Stranded, or one Flexible conductor (when applicable) is a mandatory information required by IEC, UL and CSA standards (Copper conductors). All other data are provided as supplementary information only. For more details, please consult our CB, UL or CSA certificates and technical datasheet available on <http://www.TE.com>

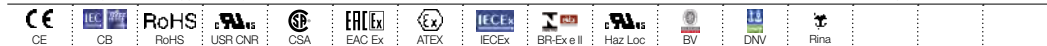

Accessories

Description	Color	Type	Part Number	Pkg qty	Weight (1 pce)	
1 End stops	Dark grey	BAZH1	1SNK900102R0000	20	24.00	
2 Terminal block markers	White	Blank marker	MG-CPM 13 41791	1680	0.27	
		Blank card	MC812	1SNK160000R0000	22	10.00
			MC812PA	1SNK169999R0000	20	14.00
	Universal wire markers holder	Grey	UMH	1SNK900611R0000	10	0.20

Complete list of accessories is indicated in the terminal block datasheet including end stops. Some accessories such as jumper bars may modify the terminal block's ratings. Complete information available in the accessories section of the catalog.

Technical data valid for copper conductors only.

ZS4-S screw clamp terminal blocks

Disconnect with blade - 5.2 mm 0.205 in spacing



Description

- Ease your disconnect operations with the disconnect blade operated by hand or with a screwdriver,
- Same profile as ZS4 feed-through terminal block for aligned marking and identical end section use.

Ordering details

Description	Color	Type	Part Number	Pkg qty	Weight (1 pce) g
Disconnect Profile aligned with ZS4	Grey <input type="checkbox"/>	ZS4-S	1SNK505310R0000	50	8.60
	Blue <input type="checkbox"/>	ZS4-S-BL	1SNK505320R0000	50	8.60
	Orange <input type="checkbox"/>	ZS4-S-OR	1SNK505330R0000	50	8.60

Main technical data

Connecting capacity		IEC	UL - CSA	Mounting instructions	
1 conductor per clamp	Rigid: Solid/Stranded	0.2 ... 4 mm ²	24 ... 10 AWG	Rail	TH 35-7.5, TH 35-15
	Flexible without ferrule	0.2 ... 4 mm ²		Wire stripping length	10.5 mm 0.412 in
	Flexible with non insulated ferrule	0.22 ... 4 mm ²	24 ... 10 AWG		
	Flexible with insulated ferrule	0.22 ... 2.5 mm ²	24 ... 14 AWG		
Gauge		A3-B3			
2 conductors per clamp	Rigid: Solid/Stranded	0.2 ... 1.5 mm ²	24 ... 16 AWG	Tool	Flat screwdriver Ø 3.5 mm Ø 0.138 in
	Flexible without ferrule	0.2 ... 1.5 mm ²			
	Flexible with twin ferrule	0.22 ... 1.5 mm ²	24 ... 16 AWG		
Rated current / Rated cross section		25 A / 4 mm ²	25 A / 10 AWG	Torque	0.6 Nm ± 0.1 5.31 lb.in ± 0.885
Rated short-time withstand current (1s)		480 A			
Rated voltage		400 V	150 V		
Impulse withstand voltage		6000 V			
Protection		IP20	NEMA 1		



ZS4-S

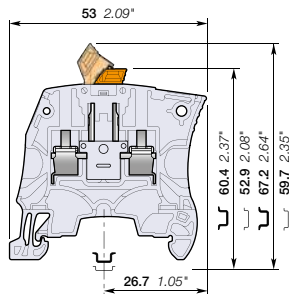

5.2 mm 0.205 in spacing

Recommendation for best usage: in horizontal assemblies, disconnect terminal blocks should be mounted with fixed foot on top (power side) so that the disconnect knife does not partially close through gravity. Furthermore, as specified per IEC 60947-7-1, disconnect terminal blocks are intended to be used for temporary disconnection at zero potential and at no load.

The connecting capacity data for one Rigid: Solid/Stranded, or one Flexible conductor (when applicable) is a mandatory information required by IEC, UL and CSA standards (Copper conductors). All other data are provided as supplementary information only. For more details, please consult our CB, UL or CSA certificates and technical datasheet available on <http://www.TE.com>

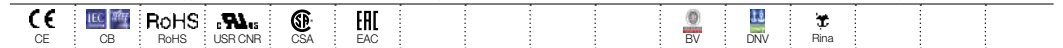

Accessories

Description	Color	Type	Part Number	Pkg qty	Weight (1 pce) g
1 End stops 10 mm 0.394 in	Dark grey <input type="checkbox"/>	BAM4	1SNK900001R0000	50	14.00
2 End sections 2.2 mm 0.087 in	Dark grey <input type="checkbox"/>	ES4	1SNK505910R0000	20	2.20
3 Lateral jumper bars 2 poles 30 A (IEC)	Grey <input type="checkbox"/>	PC5-2	1SNA113542R1000	10	1.80
		PC5-10	1SNA113544R1200	10	6.00
4 Circuit separators 3 mm 0.118 in	Dark grey <input type="checkbox"/>	CS-R1	1SNK900103R0000	20	5.20
5 Shield connectors		SHBS	1SNK900600R0000	20	3.50
6 Protecting covers 5.2 mm 0.205 in spacing	Transparent <input checked="" type="checkbox"/>	PL5	1SNK900618R0000	10	1.50
7 Terminal block markers	White <input type="checkbox"/>	MG-CPM 13 41790	1SNB041790R0512	1960	0.23
		MC512	1SNK140000R0000	22	9.00
		MC512PA	1SNK149999R0000	20	10.00
Universal wire markers holder	Grey <input type="checkbox"/>	UMH	1SNK900611R0000	10	0.20

Complete list of accessories is indicated in the terminal block datasheet including end stops.

Some accessories such as jumper bars may modify the terminal block's ratings: Complete information available in the accessories section of the catalog.



Technical data valid for copper conductors only.

ZS4-S-T screw clamp terminal blocks

Disconnect with blade - with test socket - 5.2 mm 0.205 in spacing

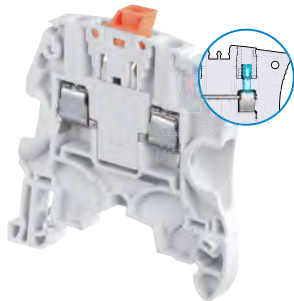

1SNK161004R0014

ZS4-S-T

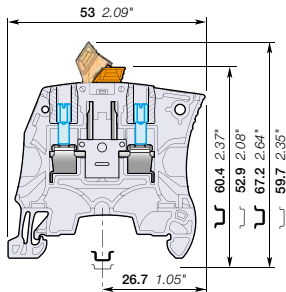

5.2 mm 0.205 in spacing

Description

- Ease your test operations with the 2 built-in test sockets,
- Screwdriver or hand operated disconnect blade,
- Same profile as ZS4 feed-through terminal block for aligned marking and identical end section use.

Ordering details

Description	Color	Type	Part Number	Pkg qty	Weight (1 pce) g
Disconnect Profile aligned with ZS4, with 2 test sockets DIA 2 mm 0.079 in	Grey <input type="checkbox"/>	ZS4-S-T2	1SNK505311R0000	50	8.90
	Blue <input type="checkbox"/>	ZS4-S-T2-BL	1SNK505321R0000	50	8.90
	Orange <input type="checkbox"/>	ZS4-S-T2-OR	1SNK505331R0000	50	8.90
	Grey <input type="checkbox"/>	ZS4-S-T2.3	1SNK505312R0000	50	8.80
Profile aligned with ZS4, with 2 test sockets DIA 2.3 mm 0.091 in					

Main technical data

Connecting capacity	IEC	UL - CSA	Rail	TH 35-7.5, TH 35-15
1 conductor per clamp	Rigid: Solid/Stranded	0.2 ... 4 mm ²	24 ... 10 AWG	10.5 mm 0.412 in
	Flexible without ferrule	0.22 ... 4 mm ²		
	Flexible with non insulated ferrule	0.22 ... 4 mm ²	24 ... 10 AWG	
	Flexible with insulated ferrule	0.22 ... 2.5 mm ²	24 ... 14 AWG	
Gauge	A3-B3			
2 conductors per clamp	Rigid: Solid/Stranded	0.2 ... 1.5 mm ²	24 ... 16 AWG	Flat screwdriver Ø 3.5 mm Ø 0.138 in
	Flexible without ferrule	0.2 ... 1.5 mm ²		
	Flexible with twin ferrule	0.22 ... 1.5 mm ²	24 ... 16 AWG	
Rated current / Rated cross section		25 A / 4 mm ²	25 A / 10 AWG	
Rated short-time withstand current (1s)		480 A		0.6 Nm ± 0.1 5.31 lb.in ± 0.885
Rated voltage		400 V	150 V	
Impulse withstand voltage		6000 V		
Protection		IP20	NEMA 1	

Mounting instructions

Recommendation for best usage: in horizontal assemblies, disconnect terminal blocks should be mounted with fixed foot on top (power side) so that the disconnect knife does not partially close through gravity. Furthermore, as specified per IEC 60947-7-1, disconnect terminal blocks are intended to be used for temporary disconnection at zero potential and at no load.

The connecting capacity data for one Rigid: Solid/Stranded, or one Flexible conductor (when applicable) is a mandatory information required by IEC, UL and CSA standards (Copper conductors). All other data are provided as supplementary information only. For more details, please consult our CB, UL or CSA certificates and technical datasheet available on <http://www.TE.com>

CE	RoHS	USF CNR	CSA	EAC
----	------	---------	-----	-----

Accessories

Description	Color	Type	Part Number	Pkg qty	Weight (1 pce) g
1 End stops 10 mm 0.394 in	Dark grey <input type="checkbox"/>	BAM4	1SNK900001R0000	50	14.00
2 End sections 2.2 mm 0.087 in	Dark grey <input type="checkbox"/>	ES4	1SNK505910R0000	20	2.20
3 Lateral jumper bars 2 poles 30 A (IEC)	Grey <input type="checkbox"/>	PC5-2	1SNA113542R1000	10	1.80
		PC5-10	1SNA113544R1200	10	6.00
4 Circuit separators 3 mm 0.118 in	Dark grey <input type="checkbox"/>	CS-R1	1SNK900103R0000	20	5.20
5 Shield connectors		SHBS	1SNK900600R0000	20	3.50
6 Protecting covers 5.2 mm 0.205 in spacing	Transparent <input checked="" type="checkbox"/>	PL5	1SNK900618R0000	10	1.50
		MG-CPM 13 41790	1SNB041790R0512	1960	0.23
7 Terminal block markers	White <input type="checkbox"/>	MC512	1SNK140000R0000	22	9.00
		MC512PA	1SNK149999R0000	20	10.00
		Universal wire markers holder	Grey <input type="checkbox"/>	UMH	1SNK900611R0000

Complete list of accessories is indicated in the terminal block datasheet including end stops. Some accessories such as jumper bars may modify the terminal block's ratings: Complete information available in the accessories section of the catalog.

Technical data valid for copper conductors only.

ZS4-S-R1 screw clamp terminal blocks

Disconnect with blade - 6 mm 0.236 in spacing

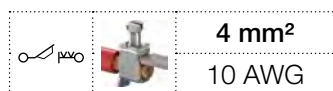

1SNK161003E0014

ZS4-S-R1

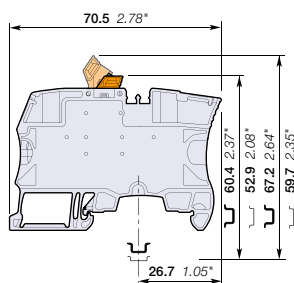

6 mm 0.236 in spacing

Description

- Simplify the alternated distribution thanks to the two jumper channels aligned with ZS4 feed-through terminal blocks,
- Ease your disconnect operations with the disconnect blade operated by hand or with a screwdriver.

Ordering details

Description	Color	Type	Part Number	Pkg qty	Weight (1 pce) g
Disconnect Profile aligned with ZS4-SF	Grey	ZS4-S-R1	1SNK506310R0000	50	13.20
	Blue	ZS4-S-R1-BL	1SNK506320R0000	50	13.20
	Orange	ZS4-S-R1-OR	1SNK506330R0000	50	13.20

Main technical data

Connecting capacity		IEC	UL - CSA	Mounting instructions	
1 conductor per clamp	Rigid: Solid/Stranded	0.2 ... 4 mm²	24 ... 10 AWG	Rail	 TH 35-7.5, TH 35-15
	Flexible without ferrule	0.22 ... 4 mm²			
	Flexible with non insulated ferrule	0.22 ... 4 mm²	24 ... 12 AWG	Wire stripping length	 10.5 mm 0.412 in
	Flexible with insulated ferrule	0.22 ... 4 mm²	24 ... 12 AWG		
	Gauge	A3-B3			
2 conductors per clamp	Rigid: Solid/Stranded	0.2 ... 1.5 mm²	24 ... 16 AWG	Tool	 Flat screwdriver Ø 3.5 mm Ø 0.138 in
	Flexible without ferrule	0.2 ... 1.5 mm²			
	Flexible with twin ferrule	0.22 ... 1.5 mm²	24 ... 16 AWG		
Rated current / Rated cross section		26 A / 4 mm²	26 A / 10 AWG	Torque	 0.6 Nm ± 0.1 5.31 lb.in ± 0.885
Rated short-time withstand current (1s)		480 A			
Rated voltage		400 V	150 V		
Impulse withstand voltage		6000 V			
Protection		IP20	NEMA 1		

Recommendation for best usage: in horizontal assemblies, disconnect terminal blocks should be mounted with fixed foot on top (power side) so that the disconnect knife does not partially close through gravity. Furthermore, as specified per IEC 60947-7-1, disconnect terminal blocks are intended to be used for temporary disconnection at zero potential and at no load.

The connecting capacity data for one Rigid: Solid/Stranded, or one Flexible conductor (when applicable) is a mandatory information required by IEC, UL and CSA standards (Copper conductors). All other data are provided as supplementary information only. For more details, please consult our CB, UL or CSA certificates and technical datasheet available on <http://www.TE.com>

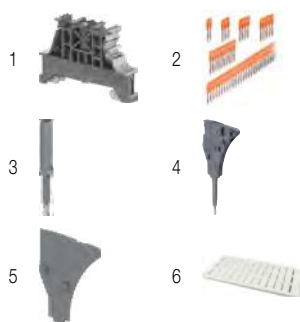
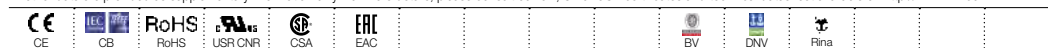

Accessories

Description	Color	Type	Part Number	Pkg qty	Weight (1 pce) g	
1 End stops	Dark grey	BAM4	1SNK900001R0000	50	14.00	
2 Jumper bars	Orange	2 poles	JB6-2	1SNK906302R0000	50	1.30
		3 poles	JB6-3	1SNK906303R0000	50	2.10
		4 poles	JB6-4	1SNK906304R0000	50	2.90
		5 poles	JB6-5	1SNK906305R0000	50	3.60
		10 poles	JB6-10	1SNK906310R0000	20	7.40
3 Test adapters	Dark grey	For test plugs DIA 2 mm 0.079 in	TP2	1SNK900203R0000	20	1.70
		For test plugs DIA 4 mm 0.157 in	TP4	1SNK900205R0000	20	2.40
4 Test connectors	Dark grey	TC5-R1	1SNK900201R0000	10	5.20	
5 Spacers	Dark grey	ES-TC6	1SNK900105R0000	10	0.80	
6 Terminal block markers	White	Blank marker	MG-CPM 13 41791	1SNB041791R0612	1680	0.27
		Blank card	MC612	1SNK150000R0000	22	10.00
			MC612PA	1SNK159999R0000	20	11.00
		Universal wire markers holder	UMH	1SNK900611R0000	10	0.20

Complete list of accessories is indicated in the terminal block datasheet including end stops.

Some accessories such as jumper bars may modify the terminal block's ratings: Complete information available in the accessories section of the catalog.

Technical data valid for copper conductors only.

ZS4-S-T-R1 screw clamp terminal blocks

Disconnect with blade - with test socket - 6 mm 0.236 in spacing



ZS4-S-T-R1

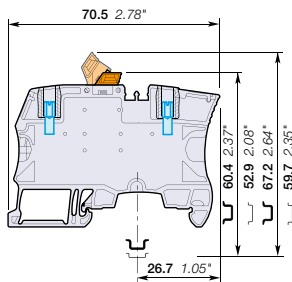

6 mm 0.236 in spacing

Description

- Ease your test operations with the 2 built-in test sockets,
- Screwdriver or hand operated disconnect blade,
- Simplify the alternated distribution thanks to the two jumper channels aligned with ZS4 feed-through terminal blocks.

Ordering details

Description	Color	Type	Part Number	Pkg qty	Weight (1 pce) g
Disconnect Profile aligned with ZS4-SF, with 2 test sockets DIA 2 mm 0.079 in	Grey	ZS4-S-T2-R1	1SNK506311R0000	50	14.20
	Blue	ZS4-S-T2-R1-BL	1SNK506321R0000	50	14.20
Profile aligned with ZS4-SF, with 2 test sockets DIA 2.3 mm 0.091 in	Orange	ZS4-S-T2-R1-OR	1SNK506331R0000	50	14.20
	Grey	ZS4-S-T2.3-R1	1SNK506312R0000	50	14.20

Main technical data

Connecting capacity	IEC	UL - CSA	Mounting instructions
1 conductor per clamp	Rigid: Solid/Stranded	0.2 ... 4 mm ²	24 ... 10 AWG
	Flexible without ferrule	0.22 ... 4 mm ²	
	Flexible with non insulated ferrule	0.22 ... 4 mm ²	24 ... 12 AWG
	Flexible with insulated ferrule	0.22 ... 4 mm ²	24 ... 12 AWG
2 conductors per clamp	Rigid: Solid/Stranded	0.2 ... 1.5 mm ²	24 ... 16 AWG
	Flexible without ferrule	0.22 ... 1.5 mm ²	24 ... 16 AWG
Rated current / Rated cross section		26 A / 4 mm ²	26 A / 10 AWG
Rated short-time withstand current (1s)		480 A	
Rated voltage		400 V	150 V
Impulse withstand voltage		6000 V	
Protection		IP20	NEMA 1

Recommendation for best usage: in horizontal assemblies, disconnect terminal blocks should be mounted with fixed foot on top (power side) so that the disconnect knife does not partially close through gravity. Furthermore, as specified per IEC 60947-7-1, disconnect terminal blocks are intended to be used for temporary disconnection at zero potential and at no load.

The connecting capacity data for one Rigid: Solid/Stranded, or one Flexible conductor (when applicable) is a mandatory information required by IEC, UL and CSA standards (Copper conductors). All other data are provided as supplementary information only. For more details, please consult our CB, UL or CSA certificates and technical datasheet available on <http://www.TE.com>

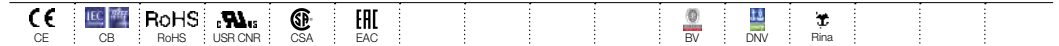

Accessories

Description	Color	Type	Part Number	Pkg qty	Weight (1 pce) g	
1 End stops	Dark grey	BAM4	1SNK900001R0000	50	14.00	
2 Jumper bars	Orange	2 poles	JB6-2	1SNK906302R0000	50	1.30
		3 poles	JB6-3	1SNK906303R0000	50	2.10
		4 poles	JB6-4	1SNK906304R0000	50	2.90
		5 poles	JB6-5	1SNK906305R0000	50	3.60
		10 poles	JB6-10	1SNK906310R0000	20	7.40
3 Test connectors	Dark grey	TC5-R1	1SNK900201R0000	10	5.20	
4 Spacers	Dark grey	ES-TC6	1SNK900105R0000	10	0.80	
5 Terminal block markers	White	Blank marker	MG-CPM 13 41791	1SNB041791R0612	1680	0.27
		Blank card	MC612	1SNK150000R0000	22	10.00
			MC612PA	1SNK159999R0000	20	11.00
	Universal wire markers holder	Grey	UMH	1SNK900611R0000	10	0.20

Complete list of accessories is indicated in the terminal block datasheet including end stops. Some accessories such as jumper bars may modify the terminal block's ratings: Complete information available in the accessories section of the catalog.

Technical data valid for copper conductors only.

ZS6-S screw clamp terminal blocks

Disconnect with blade - 6 mm 0.236 in spacing

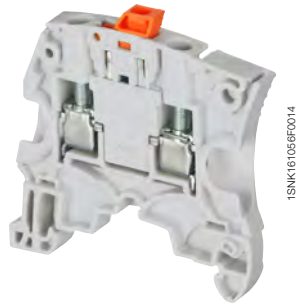

ZS6-S

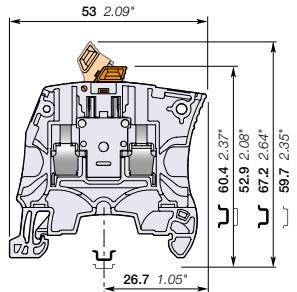

6 mm 0.236 in spacing

Description

- Ease your disconnect operations with the disconnect blade operated by hand or with a screwdriver,
- Same profile as ZS6 feed-through terminal block for aligned marking and identical end section use.

Ordering details

Description	Color	Type	Part Number	Pkg qty	Weight (1 pce) g
Disconnect Profile aligned with ZS6	Grey <input type="checkbox"/>	ZS6-S	1SNK506315R0000	50	8.60
	Blue <input type="checkbox"/>	ZS6-S-BL	1SNK506322R0000	50	8.60

Main technical data

Connecting capacity	IEC	UL - CSA	Rail	Mounting instructions
1 conductor per clamp Rigid: Solid/Stranded Flexible without ferrule Flexible with non insulated ferrule Flexible with insulated ferrule Gauge	0.2 ... 6 mm ²	24 ... 10 AWG	Wire stripping length	 TH 35-7.5, TH 35-15 10.5 mm 0.412 in
	0.22 ... 6 mm ²	24 ... 12 AWG	Tool	 Flat screwdriver Ø 4 mm Ø 0.157 in
	0.22 ... 4 mm ²	24 ... 12 AWG		
	A4-B3			
2 conductors per clamp Rigid: Solid/Stranded Flexible without ferrule Flexible with twin ferrule	0.2 ... 2.5 mm ²	24 ... 14 AWG	Torque	 0.85 Nm ± 0.15 7.52 lb.in ± 1.33
	0.22 ... 2.5 mm ²	24 ... 14 AWG		
Rated current / Rated cross section	25 A / 4 mm ²	25 A / 10 AWG		
Maximum current / Maximum cross section	30 A / 6 mm ²			
Rated short-time withstand current (1s)	480 A			
Rated voltage	500 V	300 V		
Impulse withstand voltage	6000 V			
Protection	IP20	NEMA 1		

Recommendation for best usage: in horizontal assemblies, disconnect terminal blocks should be mounted with fixed foot on top (power side) so that the disconnect knife does not partially close through gravity. Furthermore, as specified per IEC 60947-7-1, disconnect terminal blocks are intended to be used for temporary disconnection at zero potential and at no load.

The connecting capacity data for one Rigid: Solid/Stranded, or one Flexible conductor (when applicable) is a mandatory information required by IEC, UL and CSA standards (Copper conductors). All other data are provided as supplementary information only. For more details, please consult our CB, UL or CSA certificates and technical datasheet available on <http://www.TE.com>



Accessories



Description	Color	Type	Part Number	Pkg qty	Weight (1 pce) g
1 End stops 10 mm 0.394 in	Dark grey <input checked="" type="checkbox"/>	BAM4	1SNK900001R0000	50	14.00
2 End sections 2.2 mm 0.087 in	Dark grey <input checked="" type="checkbox"/>	ES4	1SNK505910R0000	20	2.20
3 Circuit separators 3 mm 0.118 in	Dark grey <input checked="" type="checkbox"/>	CS-R1	1SNK900103R0000	20	5.20
4 Shield connectors		SHBS	1SNK900600R0000	20	3.50
5 Protecting covers 6 mm 0.236 in spacing	Transparent <input checked="" type="checkbox"/>	PL6	1SNK900619R0000	10	1.80
6 Terminal block markers	Blank marker	MG-CPM 13 41791	1SNB041791R0612	1680	0.27
	Blank card	MC612	1SNK150000R0000	22	10.00
		MC612PA	1SNK159999R0000	20	11.00
Universal wire markers holder	Grey <input type="checkbox"/>	UMH	1SNK900611R0000	10	0.20

Complete list of accessories is indicated in the terminal block datasheet including end stops.

Some accessories such as jumper bars may modify the terminal block's ratings: Complete information available in the accessories section of the catalog.

Technical data valid for copper conductors only.

ZS6-S-4S-T screw clamp terminal blocks

Disconnect with blade - with test socket screws - 6 mm 0.236 in spacing



ZS6-S-4S-T

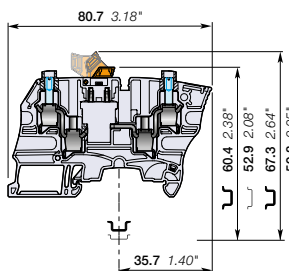

6 mm 0.236 in spacing

Description

- Recommended for energy markets and highly demanding applications requiring that only one conductor be connected per clamp,
- Ease your disconnect and test operations with the two built-in test socket screws,
- Simplify the alternated distribution thanks to the jumper channel.

Ordering details

Description	Color	Type	Part Number	Pkg qty	Weight (1 pce)
Disconnect with 2 test sockets DIA 2 mm 0,079 in	Grey <input type="checkbox"/>	ZS6-S-4S-T2	1SNK506316R0000	50	18.40

Main technical data

Connecting capacity		IEC	UL - CSA	Mounting instructions	
1 conductor per clamp	Rigid: Solid/Stranded	0.2 ... 6 mm ²	24 ... 10 AWG	Rail	TH 35-7.5, TH 35-15
	Flexible without ferrule	0.22... 6 mm ²		Wire stripping length	10.5 mm 0.413 in
	Flexible with non insulated ferrule	0.22 ... 4 mm ²	24 ... 12 AWG		
	Flexible with insulated ferrule	0.22 ... 4 mm ²	24 ... 12 AWG		
	Gauge	A4-B3		Tool	Flat screwdriver Ø 4 mm Ø 0.157 in
2 conductors per clamp	Rigid: Solid/Stranded	0.2 ... 2.5 mm ²	24 ... 14 AWG		
	Flexible without ferrule	0.2 ... 2.5 mm ²			
	Flexible with twin ferrule	0.22 ... 2.5 mm ²	24 ... 14 AWG		
Rated current / Rated cross section		27 A / 4 mm ²	28 A / 10 AWG	Torque	0.85 Nm ± 0.15 7.52 lb.in ± 1.33
Rated short-time withstand current (1s)		480 A			
Rated voltage		500 V	300 V		
Impulse withstand voltage		6000 V			
Protection		IP20	NEMA 1		

Recommendation for best usage: in horizontal assemblies, disconnect terminal blocks should be mounted with fixed foot on top (power side) so that the disconnect knife does not partially close through gravity. Furthermore, as specified per IEC 60947-7-1, disconnect terminal blocks are intended to be used for temporary disconnection at zero potential and at no load.

The connecting capacity data for one Rigid: Solid/Stranded, or one Flexible conductor (when applicable) is a mandatory information required by IEC, UL and CSA standards (Copper conductors). All other data are provided as supplementary information only. For more details, please consult our CB, UL or CSA certificates and technical datasheet available on <http://www.TE.com>

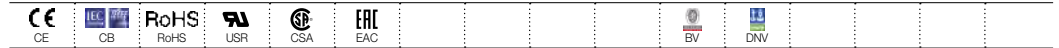

Accessories



Description	Color	Type	Part Number	Pkg qty	Weight (1 pce)		
1 End stops	Dark grey <input type="checkbox"/>	BAM4	1SNK900001R0000	50	14.00		
2 End sections	Dark grey <input type="checkbox"/>	ES6-4S	1SNK505911R0000	20	3.10		
3 Jumper bars	Orange <input type="checkbox"/>	2 poles	41 A (IEC)	1SNK906302R0000	50	1.30	
		3 poles	41 A (IEC)	JB6-3	1SNK906303R0000	50	2.10
		4 poles	41 A (IEC)	JB6-4	1SNK906304R0000	50	2.90
		5 poles	41 A (IEC)	JB6-5	1SNK906305R0000	50	3.60
		10 poles	41 A (IEC)	JB6-10	1SNK906310R0000	20	7.40
4 Circuit separators	Dark grey <input type="checkbox"/>	CS-R1	1SNK900103R0000	20	5.20		
5 Test adapters	Dark grey <input type="checkbox"/>	For test plugs DIA 2 mm 0.079 in	TP2	1SNK900203R0000	20	1.70	
		For test plugs DIA 4 mm 0.157 in	TP4	1SNK900205R0000	20	2.40	
6 Test connectors	Dark grey <input type="checkbox"/>	TC5-R1	1SNK900201R0000	10	5.20		
7 Spacers	Dark grey <input type="checkbox"/>	ES-TC6	1SNK900105R0000	10	0.80		
8 Terminal block markers	White <input type="checkbox"/>	MG-CPM 13 41791	1SNB041791R0612	1680	0.27		
		MC612	1SNK150000R0000	22	10.00		
		MC612PA	1SNK159999R0000	20	11.00		
	Grey <input type="checkbox"/>	UMH	1SNK900611R0000	10	0.20		

Complete list of accessories is indicated in the terminal block datasheet including end stops. Some accessories such as jumper bars may modify the terminal block's ratings: Complete information available in the accessories section of the catalog.

Technical data valid for copper conductors only.

ZS10-S screw clamp terminal blocks

Disconnect with blade - 8 mm 0.315 in spacing



ZS10-S

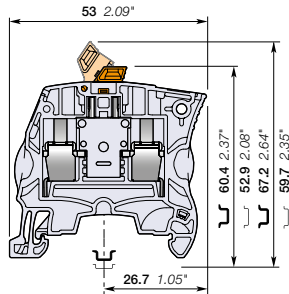

8 mm 0.315 in spacing

Description

- Ease your disconnect operations with the disconnect blade operated by hand or with a screwdriver,
- Same profile as ZS10 feed-through terminal block for aligned marking and identical end section use.

Ordering details

Description	Color	Type	Part Number	Pkg qty	Weight (1 pce) g
Disconnect Profile aligned with ZS10	Grey <input type="checkbox"/>	ZS10-S	1SNK508315R0000	50	8.60
	Blue <input type="checkbox"/>	ZS10-S-BL	1SNK508320R0000	50	8.60

Main technical data

Connecting capacity		IEC	UL - CSA	Mounting instructions	
1 conductor per clamp	Rigid: Solid/Stranded	0.2 ... 10 mm ²	24 ... 6 AWG	Rail	TH 35-7.5, TH 35-15
	Flexible without ferrule	0.22 ... 10 mm ²		Wire stripping length	12 mm 0.472 in
	Flexible with non insulated ferrule	0.22 ... 10 mm ²	24 ... 12 AWG		
	Flexible with insulated ferrule	0.22 ... 6 mm ²	24 ... 12 AWG		
Gauge		A5-B5			
2 conductors per clamp	Rigid: Solid/Stranded	0.5 ... 4 mm ²	20 ... 12 AWG	Tool	Flat screwdriver Ø 4 mm Ø 0.157 in
	Flexible without ferrule	0.5 ... 4 mm ²	20 ... 12 AWG		
	Flexible with twin ferrule	0.5 ... 4 mm ²	20 ... 12 AWG		
Rated current / Rated cross section		25 A / 4 mm ²	25 A / 6 AWG	Torque	1.3 Nm ± 0.3 11.5 lb.in ± 2.65
Maximum current / Maximum cross section		42 A / 10 mm ²			
Rated short-time withstand current (1s)		480 A			
Rated voltage		630 V	300 V		
Impulse withstand voltage		6000 V			
Protection		IP20	NEMA 1		

Recommendation for best usage: in horizontal assemblies, disconnect terminal blocks should be mounted with fixed foot on top (power side) so that the disconnect knife does not partially close through gravity. Furthermore, as specified per IEC 60947-7-1, disconnect terminal blocks are intended to be used for temporary disconnection at zero potential and at no load.

The connecting capacity data for one Rigid: Solid/Stranded, or one Flexible conductor (when applicable) is a mandatory information required by IEC, UL and CSA standards (Copper conductors). All other data are provided as supplementary information only. For more details, please consult our CB, UL or CSA certificates and technical datasheet available on <http://www.TE.com>



Accessories

Description	Color	Type	Part Number	Pkg qty	Weight (1 pce) g
1 End stops	Dark grey <input checked="" type="checkbox"/>	BAM4	1SNK900001R0000	50	14.00
2 End sections	Dark grey <input checked="" type="checkbox"/>	ES4	1SNK505910R0000	20	2.20
3 Circuit separators	Dark grey <input checked="" type="checkbox"/>	CS-R1	1SNK900103R0000	20	5.20
4 Terminal block markers	White <input type="checkbox"/>	MG-CPM 13 41791	1SNB041791R0612	1680	0.27
		MC812	1SNK160000R0000	22	10.00
		MC812PA	1SNK169999R0000	20	14.00
Universal wire markers holder	Grey <input type="checkbox"/>	UMH	1SNK900611R0000	10	0.20

Complete list of accessories is indicated in the terminal block datasheet including end stops. Some accessories such as jumper bars may modify the terminal block's ratings. Complete information available in the accessories section of the catalog.

Technical data valid for copper conductors only.

ZS4-SP screw clamp terminal blocks

Disconnect with plug - 5.2 mm 0.205 in spacing



ZS4-SP

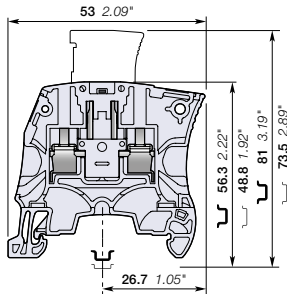

5.2 mm 0.205 in spacing

Description

- Save time with our screwless component holder plug,
- Same profile as ZS4 feed-through terminal block for aligned marking and identical end section use.

Ordering details

Description	Color	Type	Part Number	Pkg qty	Weight (1 pce)
Disconnect Profile aligned with ZS4, plug delivered separately	Grey <input type="checkbox"/>	ZS4-SP	1SNK505313R0000	50	8.20

Main technical data

Connecting capacity		IEC	UL - CSA	Mounting instructions	
1 conductor per clamp	Rigid: Solid/Stranded	0.2 ... 4 mm ²	24 ... 10 AWG	Rail	TH 35-7.5, TH 35-15
	Flexible without ferrule	0.22 ... 4 mm ²		Wire stripping length	10.5 mm 0.412 in
	Flexible with non insulated ferrule	0.22 ... 4 mm ²	24 ... 10 AWG	Tool	Flat screwdriver Ø 3.5 mm Ø 0.138 in
	Flexible with insulated ferrule	0.22 ... 2.5 mm ²	24 ... 14 AWG		
Gauge		A3-B3		Torque	0.6 Nm ± 0.1 5.31 lb.in ± 0.885
2 conductors per clamp	Rigid: Solid/Stranded	0.2 ... 1.5 mm ²	24 ... 16 AWG		
	Flexible without ferrule	0.2 ... 1.5 mm ²	24 ... 16 AWG		
Flexible with twin ferrule		0.22 ... 1.5 mm ²	24 ... 16 AWG		
Rated current / Rated cross section		18 A / 2.5 mm ²	18 A / 10 AWG		
Rated short-time withstand current (1s)		300 A			
Rated voltage		400 V	150 V		
Impulse withstand voltage		6000 V			
Protection		IP20	NEMA 1		

The connecting capacity data for one Rigid: Solid/Stranded, or one Flexible conductor (when applicable) is a mandatory information required by IEC, UL and CSA standards (Copper conductors). All other data are provided as supplementary information only. For more details, please consult our CB, UL or CSA certificates and technical datasheet available on <http://www.TE.com>

--	--	--	--	--	--	--	--	--	--

Accessories

Description	Color	Type	Part Number	Pkg qty	Weight (1 pce)
1 End stops 10 mm 0.394 in	Dark grey <input checked="" type="checkbox"/>	BAM4	1SNK900001R0000	50	14.00
2 End sections 2.2 mm 0.087 in	Dark grey <input checked="" type="checkbox"/>	ES4	1SNK505910R0000	20	2.20
3 Lateral jumper bars 2 poles 30 A (IEC)	Grey <input type="checkbox"/>	PC5-2	1SNA113542R1000	10	1.80
		PC5-10	1SNA113544R1200	10	6.00
4 Shield connectors		SHBS	1SNK900600R0000	20	3.50
5 Component plugs Components in series with circuit	Dark grey <input checked="" type="checkbox"/>	PG5	1SNK900401R0000	20	3.50
6 Disconnect plugs Equipped with linking bar	Orange <input checked="" type="checkbox"/>	PG5-R1	1SNK900402R0000	20	3.50
7 Terminal block markers	White <input type="checkbox"/>	MG-CPM 13 41790	1SNB041790R0512	1960	0.23
		MC512	1SNK140000R0000	22	9.00
		MC512PA	1SNK149999R0000	20	10.00
Universal wire markers holder	Grey <input type="checkbox"/>	UMH	1SNK900611R0000	10	0.20

Complete list of accessories is indicated in the terminal block datasheet including end stops. Some accessories such as jumper bars may modify the terminal block's ratings: Complete information available in the accessories section of the catalog.

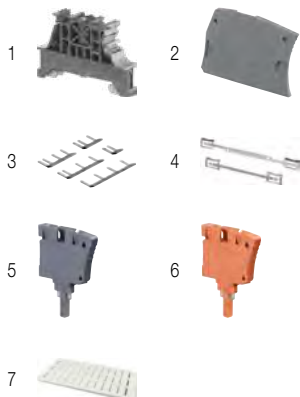

Technical data valid for copper conductors only.

ZS4-SP-T2 screw clamp terminal blocks

Disconnect with plug - with test socket - 5.2 mm 0.205 in spacing

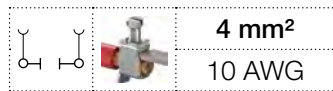

ZS4-SP-T2

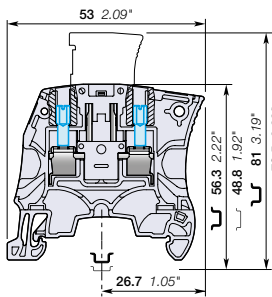

5.2 mm 0.205 in spacing

Description

- Ease your test operations with the 2 built-in test sockets DIA 2 mm 0.079 in,
- Save time with our screwless component holder plug,
- Same profile as ZS4 feed-through terminal block for aligned marking and identical end section use.

Ordering details

Description	Color	Type	Part Number	Pkg qty	Weight (1 pce) g
Disconnect Profile aligned with ZS4, with 2 test sockets DIA 2 mm 0.079 in, plug delivered separately	Grey <input type="checkbox"/>	ZS4-SP-T2	1SNK505314R0000	50	8.40

Main technical data

Connecting capacity	IEC	UL - CSA	Mounting instructions		
			Rail	TH 35-7.5, TH 35-15	
1 conductor per clamp	Rigid: Solid/Stranded	0.2 ... 4 mm ²	24 ... 10 AWG	Wire stripping length	10.5 mm 0.412 in
	Flexible without ferrule	0.22 ... 4 mm ²			
	Flexible with non insulated ferrule	0.22 ... 4 mm ²	24 ... 10 AWG		
	Flexible with insulated ferrule	0.22 ... 2.5 mm ²	24 ... 14 AWG		
	Gauge	A3-B3			
2 conductors per clamp	Rigid: Solid/Stranded	0.2 ... 1.5 mm ²	24 ... 16 AWG	Tool	Flat screwdriver Ø 3.5 mm Ø 0.138 in
	Flexible without ferrule	0.2 ... 1.5 mm ²			
	Flexible with twin ferrule	0.22 ... 1.5 mm ²	24 ... 16 AWG		
Rated current / Rated cross section		18 A / 2.5 mm ²	18 A / 10 AWG		
Rated short-time withstand current (1s)		300 A		Torque	0.6 Nm ± 0.1 5.31 lb.in ± 0.885
Rated voltage		400 V	150 V		
Impulse withstand voltage		6000 V			
Protection		IP20	NEMA 1		

The connecting capacity data for one Rigid: Solid/Stranded, or one Flexible conductor (when applicable) is a mandatory information required by IEC, UL and CSA standards (Copper conductors). All other data are provided as supplementary information only. For more details, please consult our CB, UL or CSA certificates and technical datasheet available on <http://www.TE.com>

--	--	--	--	--	--	--	--	--	--	--

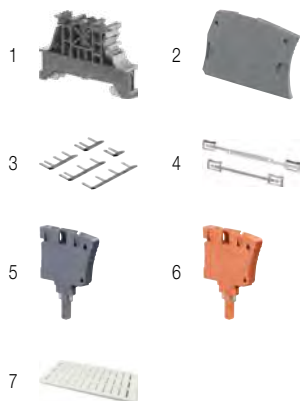

Accessories

Description	Color	Type	Part Number	Pkg qty	Weight (1 pce) g
1 End stops 10 mm 0.394 in	Dark grey <input checked="" type="checkbox"/>	BAM4	1SNK900001R0000	50	14.00
2 End sections 2.2 mm 0.087 in	Dark grey <input checked="" type="checkbox"/>	ES4	1SNK505910R0000	20	2.20
3 Lateral jumper bars 2 poles 30 A (IEC)	Grey <input type="checkbox"/>	PC5-2	1SNA113542R1000	10	1.80
		PC5-10	1SNA113544R1200	10	6.00
4 Shield connectors		SHBS	1SNK900600R0000	20	3.50
5 Component plugs Components in series with circuit	Dark grey <input checked="" type="checkbox"/>	PG5	1SNK900401R0000	20	3.50
6 Disconnect plugs Equipped with linking bar	Orange <input checked="" type="checkbox"/>	PG5-R1	1SNK900402R0000	20	3.50
7 Terminal block markers	White <input type="checkbox"/>	MG-CPM 13 41790	1SNB041790R0512	1960	0.23
		MC512	1SNK140000R0000	22	9.00
		MC512PA	1SNK149999R0000	20	10.00
Universal wire markers holder	Grey <input type="checkbox"/>	UMH	1SNK900611R0000	10	0.20

Complete list of accessories is indicated in the terminal block datasheet including end stops. Some accessories such as jumper bars may modify the terminal block's ratings. Complete information available in the accessories section of the catalog.

Technical data valid for copper conductors only.

ZS4-SP-R1 screw clamp terminal blocks

Disconnect with plug - 6 mm 0.236 in spacing



ZS4-SP-R1

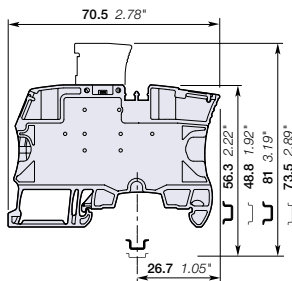

6 mm 0.236 in spacing

Description

- Simplify the alternated distribution between feed-through and disconnect circuits thanks to the two aligned jumper channels,
- Save time with our screwless component holder plug.

Ordering details

Description	Color	Type	Part Number	Pkg qty	Weight (1 pce) g
Disconnect Profile aligned with ZS4-SF, plug delivered separately	Grey <input type="checkbox"/>	ZS4-SP-R1	1SNK506313R0000	50	14.20

Main technical data

Connecting capacity		IEC	UL - CSA	Mounting instructions	
1 conductor per clamp	Rigid: Solid/Stranded	0.2 ... 4 mm ²	24 ... 10 AWG	Rail	TH 35-7.5, TH 35-15
	Flexible without ferrule	0.22 ... 4 mm ²	24 ... 12 AWG	Wire stripping length	10.5 mm 0.412 in
	Flexible with non insulated ferrule	0.22 ... 4 mm ²	24 ... 12 AWG	Tool	Flat screwdriver Ø 3.5 mm Ø 0.138 in
	Flexible with insulated ferrule	0.22 ... 4 mm ²	24 ... 12 AWG		
Gauge		A3-B3		Torque	0.6 Nm ± 0.1 5.31 lb.in ± 0.885
2 conductors per clamp	Rigid: Solid/Stranded	0.2 ... 1.5 mm ²	24 ... 16 AWG		
	Flexible without ferrule	0.2 ... 1.5 mm ²	24 ... 16 AWG		
	Flexible with twin ferrule	0.22 ... 1.5 mm ²	24 ... 16 AWG		
Rated current / Rated cross section		18 A / 2.5 mm ²	20 A / 10 AWG		
Rated short-time withstand current (1s)		300 A			
Rated voltage		400 V	150 V		
Impulse withstand voltage		6000 V			
Protection		IP20	NEMA 1		

The connecting capacity data for one Rigid: Solid/Stranded, or one Flexible conductor (when applicable) is a mandatory information required by IEC, UL and CSA standards (Copper conductors). All other data are provided as supplementary information only. For more details, please consult our CB, UL or CSA certificates and technical datasheet available on <http://www.TE.com>

--	--	--	--	--

Accessories

Description	Color	Type	Part Number	Pkg qty	Weight (1 pce) g	
1 End stops	Dark grey <input type="checkbox"/>	BAM4	1SNK900001R0000	50	14.00	
2 Jumper bars	Orange <input type="checkbox"/>	2 poles	JB6-2	1SNK906302R0000	50	1.30
		3 poles	JB6-3	1SNK906303R0000	50	2.10
		4 poles	JB6-4	1SNK906304R0000	50	2.90
		5 poles	JB6-5	1SNK906305R0000	50	3.60
		10 poles	JB6-10	1SNK906310R0000	20	7.40
3 Test adapters	Dark grey <input type="checkbox"/>	For test plugs DIA 2 mm 0.079 in	TP2	1SNK900203R0000	20	1.70
		For test plugs DIA 4 mm 0.157 in	TP4	1SNK900205R0000	20	2.40
4 Test connectors	Dark grey <input type="checkbox"/>	End module, 5.2 mm 0.205 in	TC5-R1	1SNK900201R0000	10	5.20
5 Spacers	Dark grey <input type="checkbox"/>	0.8 mm 0.031 in	ES-TC6	1SNK900105R0000	10	0.80
6 Component plugs	Dark grey <input type="checkbox"/>	Components in series with circuit	PG5	1SNK900401R0000	20	3.50
7 Disconnect plugs	Orange <input type="checkbox"/>	Equipped with linking bar	PG5-R1	1SNK900402R0000	20	3.50
8 Terminal block markers	White <input type="checkbox"/>	Blank marker	MG-CPM 13 41791	1SNB041791R0612	1680	0.27
		Blank card	MC612	1SNK150000R0000	22	10.00
		Universal wire markers holder	UMH	1SNK159999R0000	20	11.00
	Grey <input type="checkbox"/>		UMH	1SNK900611R0000	10	0.20

Complete list of accessories is indicated in the terminal block datasheet including end stops. Some accessories such as jumper bars may modify the terminal block's ratings: Complete information available in the accessories section of the catalog.

Technical data valid for copper conductors only.

ZS4-SP-T2-R1 screw clamp terminal blocks

Disconnect with plug - with test socket - 6 mm 0.236 in spacing

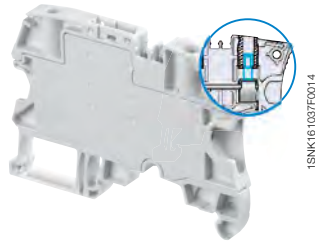
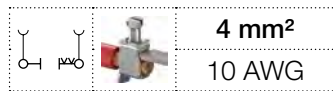

ZS4-SP-T2-R1

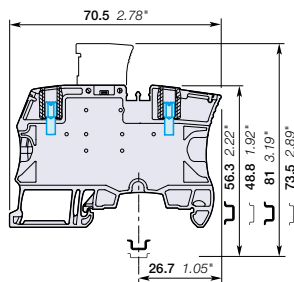

6 mm 0.236 in spacing

Description

- Ease your test operations with the 2 built-in test sockets DIA 2 mm 0.079 in,
- Save time with our screwless component holder plug,
- Simplify the distribution between feed-through and disconnect circuits thanks to the two aligned jumper channels.

Ordering details

Description	Color	Type	Part Number	Pkg qty	Weight (1 pce) g
Disconnect Profile aligned with ZS4-SF, with 2 test sockets DIA 2 mm 0.079 in, plug delivered separately	Grey <input type="checkbox"/>	ZS4-SP-T2-R1	1SNK506314R0000	50	14.20

Main technical data

Connecting capacity		IEC	UL - CSA	Mounting instructions	
1 conductor per clamp	Rigid: Solid/Stranded	0.2 ... 4 mm²	24 ... 10 AWG	Rail	TH 35-7.5, TH 35-15
	Flexible without ferrule	0.22 ... 4 mm²		Wire stripping length	10.5 mm 0.412 in
	Flexible with non insulated ferrule	0.22 ... 4 mm²	24 ... 12 AWG	Tool	Flat screwdriver Ø 3.5 mm Ø 0.138 in
	Flexible with insulated ferrule	0.22 ... 4 mm²	24 ... 12 AWG		
Gauge		A3-B3		Torque	0.6 Nm ± 0.1 5.31 lb.in ± 0.85
2 conductors per clamp	Rigid: Solid/Stranded	0.2 ... 1.5 mm²	24 ... 16 AWG		
		Flexible without ferrule	0.2 ... 1.5 mm²		
		Flexible with twin ferrule	0.22 ... 1.5 mm²		
Rated current / Rated cross section		18 A / 2.5 mm²	20 A / 10 AWG		
Rated short-time withstand current (1s)		300 A			
Rated voltage		400 V	150 V		
Impulse withstand voltage		6000 V			
Protection		IP20	NEMA 1		

The connecting capacity data for one Rigid: Solid/Stranded, or one Flexible conductor (when applicable) is a mandatory information required by IEC, UL and CSA standards (Copper conductors). All other data are provided as supplementary information only. For more details, please consult our CB, UL or CSA certificates and technical datasheet available on <http://www.TE.com>

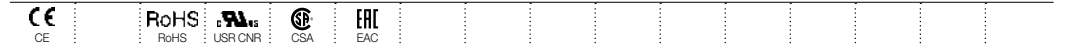

Accessories

Description	Color	Type	Part Number	Pkg qty	Weight (1 pce) g	
1 End stops	Dark grey <input checked="" type="checkbox"/>	BAM4	1SNK900001R0000	50	14.00	
2 Jumper bars	Orange <input checked="" type="checkbox"/>	2 poles 41 A (IEC)	JB6-2	1SNK906302R0000	50	1.30
		3 poles 41 A (IEC)	JB6-3	1SNK906303R0000	50	2.10
		4 poles 41 A (IEC)	JB6-4	1SNK906304R0000	50	2.90
		5 poles 41 A (IEC)	JB6-5	1SNK906305R0000	50	3.60
		10 poles 41 A (IEC)	JB6-10	1SNK906310R0000	20	7.40
3 Test connectors	Dark grey <input checked="" type="checkbox"/>	TC5-R1	1SNK900201R0000	10	5.20	
4 Spacers	Dark grey <input checked="" type="checkbox"/>	ES-TC6	1SNK900105R0000	10	0.80	
5 Component plugs	Dark grey <input checked="" type="checkbox"/>	PG5	1SNK900401R0000	20	3.50	
6 Disconnect plugs	Orange <input checked="" type="checkbox"/>	PG5-R1	1SNK900402R0000	20	3.50	
7 Terminal block markers	White <input checked="" type="checkbox"/>	Blank marker	MG-CPM 13 41791	1SNB041791R0612	1680	0.27
		Blank card	MC612	1SNK150000R0000	22	10.00
			MC612PA	1SNK159999R0000	20	11.00
		Universal wire markers holder	Grey <input type="checkbox"/>	UMH	1SNK900611R0000	10

Complete list of accessories is indicated in the terminal block datasheet including end stops. Some accessories such as jumper bars may modify the terminal block's ratings: Complete information available in the accessories section of the catalog.



Technical data valid for copper conductors only.

ZS10-SP screw clamp terminal blocks

Disconnect with plug - 8 mm 0.315 in spacing

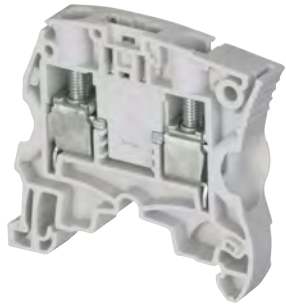

ZS10-SP

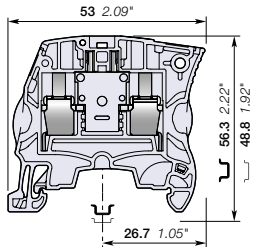

8 mm 0.315 in spacing

Description

- Save time with our screwless component holder plug,
- Same profile as ZS10 feed-through terminal block for aligned marking and identical end section use.

Ordering details

Description	Color	Type	Part Number	Pkg qty	Weight (1 pce) g
Disconnect Profile aligned with ZS10	Grey <input type="checkbox"/>	ZS10-SP	1SNK508316R0000	50	8.60

Main technical data

Connecting capacity		IEC	UL - CSA	Mounting instructions	
1 conductor per clamp	Rigid: Solid/Stranded	0.2 ... 10 mm ²	24 ... 6 AWG	Rail	TH 35-7.5, TH 35-15
	Flexible without ferrule	0.22 ... 10 mm ²	24 ... 8 AWG	Wire stripping length	12 mm 0.472 in
	Flexible with non insulated ferrule	0.22 ... 10 mm ²	24 ... 8 AWG	Tool	Flat screwdriver Ø 4 mm Ø 0.157 in
	Flexible with insulated ferrule	0.22 ... 6 mm ²	24 ... 8 AWG		
Gauge		A5-B5		Torque	1.3 Nm ± 0.3 11.5 lb.in ± 2.65
2 conductors per clamp	Rigid: Solid/Stranded	0.5 ... 4 mm ²	20 ... 12 AWG		
2 conductors per clamp	Flexible without ferrule	0.5 ... 4 mm ²	20 ... 12 AWG	Torque	1.3 Nm ± 0.3 11.5 lb.in ± 2.65
	Flexible with twin ferrule	0.5 ... 4 mm ²	20 ... 12 AWG		
	Rated current / Rated cross section	18 A / 2.5 mm ²	18 A / 6 AWG		
Maximum current / Maximum cross section		18 A / 10 mm ²			
Rated short-time withstand current (1s)		300 A			
Rated voltage		630 V	300 V		
Impulse withstand voltage		6000 V			
Protection		IP20	NEMA 1		

The connecting capacity data for one Rigid: Solid/Stranded, or one Flexible conductor (when applicable) is a mandatory information required by IEC, UL and CSA standards (Copper conductors). All other data are provided as supplementary information only. For more details, please consult our CB, UL or CSA certificates and technical datasheet available on <http://www.TE.com>

--	--	--	--	--

Accessories

Description	Color	Type	Part Number	Pkg qty	Weight (1 pce) g
1 End stops 10 mm 0.394 in	Dark grey <input checked="" type="checkbox"/>	BAM4	1SNK900001R0000	50	14.00
2 End sections 2.2 mm 0.087 in	Dark grey <input checked="" type="checkbox"/>	ES4	1SNK505910R0000	20	2.20
3 Component plugs Components in series with circuit	Dark grey <input checked="" type="checkbox"/>	PG5	1SNK900401R0000	20	3.50
4 Disconnect plugs Equipped with linking bar	Orange <input checked="" type="checkbox"/>	PG5-R1	1SNK900402R0000	20	3.50
5 Terminal block markers	White <input type="checkbox"/>	MG-CPM 13 41791	1SNB041791R0612	1680	0.27
		MC812	1SNK160000R0000	22	10.00
		MC812PA	1SNK169999R0000	20	14.00
Universal wire markers holder	Grey <input type="checkbox"/>	UMH	1SNK900611R0000	10	0.20

Complete list of accessories is indicated in the terminal block datasheet including end stops. Some accessories such as jumper bars may modify the terminal block's ratings: Complete information available in the accessories section of the catalog.



SNK series, terminal blocks

Fuse protection



Optimize your control circuit protection

Our SNK series fuse terminal blocks offer a full set of features and functions to protect your control circuits with efficiency and reliability.

All terminal blocks complies with the latest evolution of the international standards IEC 60947-7-3 ("Ancillary equipment safety requirements for fuse terminal blocks.") which fixes precise temperature constraint for short-circuit and overload protection (information in the catalogue pages related to the products).

Qualified for worldwide markets and applications

Eco-designed according to international environmental standards in sustainable development.



Select the right fuse holder for the right application

1 standard applications

The standard fuse holders feature compact dimensions while offering compatibility with 5 x 20 and 5 x 25 mm fuses. double deck terminal blocks allow efficient space reduction for panels with space constraints.

2 Expert for convenient circuit distribution

The expert fuse holders are equipped with two central jumper channels for convenient common distribution and are aligned with feed-through and disconnect terminal blocks. They facilitate alternated potential distribution and reduce wiring.

Additional features for easy trouble shooting and testing

Performant blown fuse indicators

Low leakage current (< 0.5 mA) allows the protection of low current circuits such as PLC's inputs without any risk of circuit disturbances.

Large voltage range (24/110 V and 110/250 V AC/DC) reduces the number of variants and allows adaptation to worldwide applications (24/110 V range covers North american market needs).

Easy testing

Some terminal blocks are equipped with Dia 2 mm built-in test socket screws for circuit testing while respecting the IP20 touch proof protection.



1
5x20 and 5x25 mm fuses
Compact and high density



2
5x20 and 6.3x32 mm fuses
Easy potential distribution

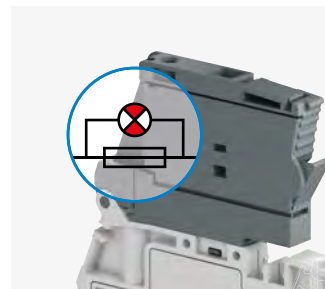

Low leakage current blown fuse indicator.
Large voltage range: (24/110 V and 110/250 V AC and DC)

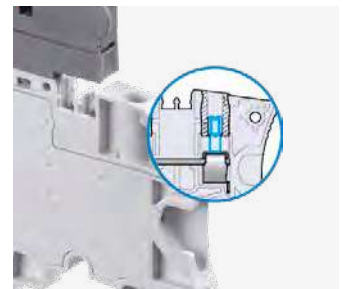

Convenient testing through built in test socket screws

1SNK16108550201

SNK series, terminal blocks

Marshalling cabinets application

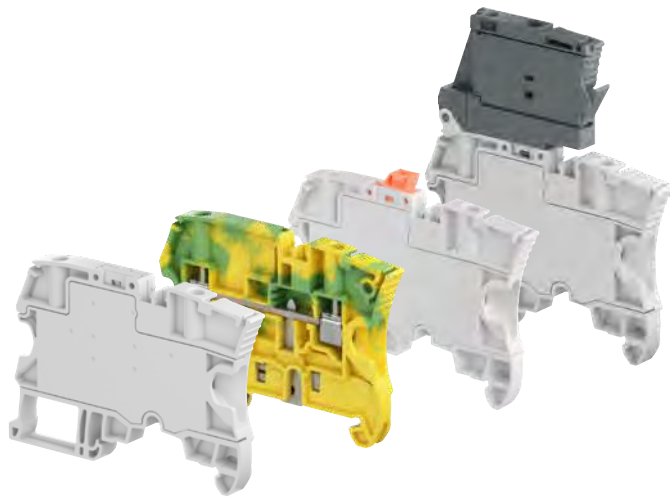

The smart choice for process automation

Large process automation applications typically require the use of a large number of digital or analog signals and sensors. Indeed, marshalling cabinets ensure an important cross wiring function, since the incoming field signal and the channel quantity of the I/O card of the controller (DCS, large PLC's) is always different. They facilitate the maintenance operations and ease the system modifications.

SNK aligned terminal blocks offering:

SNK series now features a full set of aligned terminal blocks matching the marshalling panels typical configurations. Fuse, disconnect, feed-through and ground terminal blocks with identical profile are providing compact and convenient solution. With only 6 mm spacing, two aligned screwless jumper channels, central large marking as well as aligned conductor entries, they are perfectly adapted to alternative potential distribution while still easy to connect.

Typical marshalling configurations

Digital signals

Popular potential distribution via double center channel.

Disconnect functions equipped with test points allow total isolation of circuits, ease circuit testing during start-up, test and maintenance operations.

Analog

Potential distribution for analog signals. Ground terminal blocks allow reliable connection of cable shields to the ground sparing the use of external shield bar.

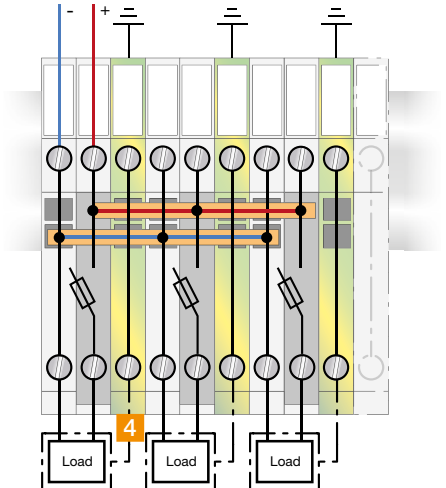
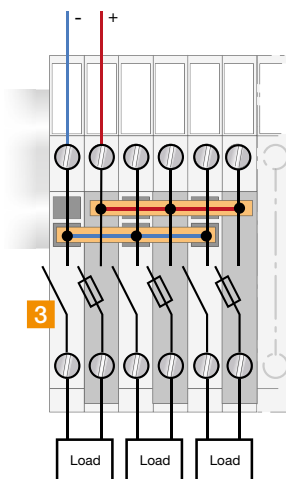
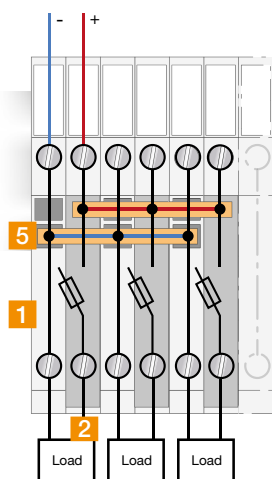

1SNK161086S0201

ZS4-SF1 screw clamp terminal blocks

For 5 x 20 and 5 x 25 fuses - 8 mm 0.315 in spacing

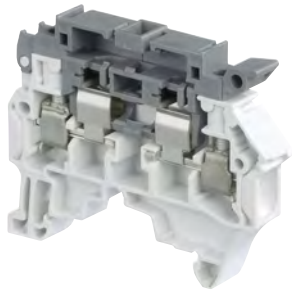

ZS4-SF1

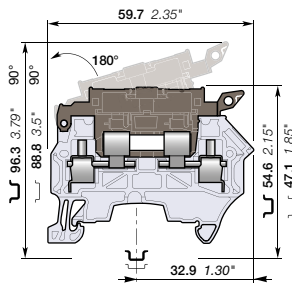

8 mm 0.315 in spacing

Description

Protect your circuit with 5x25 and 5x20 fuse terminal blocks, compliant with IEC 60947-7-3 standard (fuse not supplied with the terminal blocks).

Ordering details

Description	Color	Type	Part Number	Pkg qty	Weight (1 pce) g
Fuse	Grey, dark grey	ZS4-SF1	1SNK508410R0000	50	13.30
	Orange, dark grey	ZS4-SF1-OR	1SNK508430R0000	50	13.30

Main technical data

Connecting capacity		IEC	UL - CSA	Mounting instructions	
1 conductor per clamp	Rigid: Solid/Stranded	0.2 ... 4 mm²	24 ... 10 AWG	Rail	TH 35-7.5, TH 35-15
	Flexible without ferrule	0.22 ... 4 mm²		Wire stripping length	11 mm 0.432 in
	Flexible with non insulated ferrule	0.22 ... 4 mm²	24 ... 12 AWG		
	Flexible with insulated ferrule	0.22 ... 4 mm²	24 ... 12 AWG		
	Gauge	A3-B3			
2 conductors per clamp	Rigid: Solid/Stranded	0.2 ... 2.5 mm²	24 ... 14 AWG	Tool	Flat screwdriver Ø 3.5 mm Ø 0.138 in
	Flexible without ferrule	0.2 ... 2.5 mm²			
	Flexible with twin ferrule	0.22 ... 2.5 mm²	24 ... 14 AWG		
Rated current / Rated cross section		6.3 A / 4 mm²	10 A / 10 AWG	Torque	0.6 Nm ± 0.1 5.31 lb.in ± 0.885
Rated voltage		630 V	300 V		
Impulse withstand voltage		8000 V			
Protection		IP20	NEMA 1		

Separate arrangement		Assembly composed of 1 fuse terminal block in between non fuse terminal blocks	Overload and short-circuit protection	2.5 W
			Exclusive short-circuit protection	4 W
Compound arrangement		Assembly composed of 5 fuse terminal blocks	Overload and short-circuit protection	1.6 W
			Exclusive short-circuit protection	4 W

The connecting capacity data for one Rigid: Solid/Stranded, or one Flexible conductor (when applicable) is a mandatory information required by IEC, UL and CSA standards (Copper conductors). All other data are provided as supplementary information only. For more details, please consult our CB, UL or CSA certificates and technical datasheet available on <http://www.TE.com>

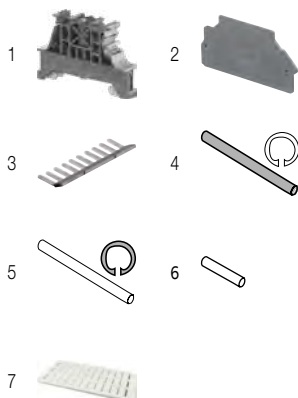
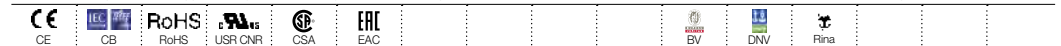

Accessories

Description	Color	Type	Part Number	Pkg qty	Weight (1 pce) g
1 End stops	Dark grey	BAM4	1SNK900001R0000	50	14.00
2 End sections	Dark grey	ES4-SF	1SNK508960R0000	20	1.80
3 Lateral jumper bars	Grey	PC81-10	1SNA173523R1100	10	5.00
4 Assembly rods		TGA8	1SNA168672R1100	10	1.00
		TGA8	1SNA168673R1200	10	1.50
		TGA8	1SNA168674R1300	10	2.00
5 Spring retaining Rings		ANT	1SNA168675R1400	10	
6 Neutral cartridge		CN5	1SNA179371R1600	10	3.9
7 Terminal block markers	White	MG-CPM 13 41791	1SNB041791R0612	1680	0.27
		MC812	1SNK160000R0000	22	10.00
		MC812PA	1SNK169999R0000	20	14.00
	Grey	UMH	1SNK900611R0000	10	0.20

Complete list of accessories is indicated in the terminal block datasheet including end stops.

Some accessories such as jumper bars may modify the terminal block's ratings: Complete information available in the accessories section of the catalog.

Technical data valid for copper conductors only.

ZS4-SF1-T screw clamp terminal blocks

For 5 x 20 and 5 x 25 fuses - with test socket - 8 mm 0.315 in spacing

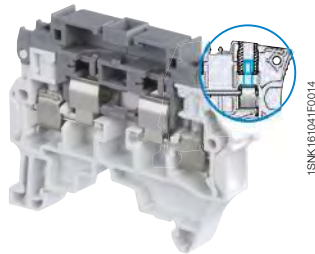

ZS4-SF1-T

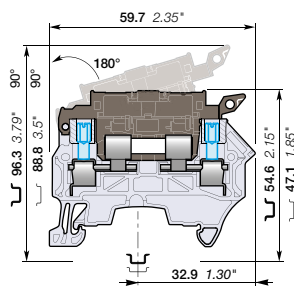

8 mm 0.315 in spacing

Description

- Protect your circuit with 5x25 and 5x20 fuse terminal blocks (fuse not supplied with the terminal blocks),
- Compliant with IEC 60947-7-3 standard,
- With built in test sockets.

Ordering details

Description	Color	Type	Part Number	Pkg qty	Weight (1 pce) g
Fuse With 2 test sockets DIA 2 mm 0.079 in	Grey, dark grey	ZS4-SF1-T2	1SNK508411R0000	50	13.30

Main technical data

Connecting capacity		IEC	UL - CSA	Mounting instructions	
1 conductor per clamp	Rigid: Solid/Stranded	0.2 ... 4 mm ²	24 ... 10 AWG	Rail	TH 35-7.5, TH 35-15
	Flexible without ferrule	0.22 ... 4 mm ²	24 ... 12 AWG	Wire stripping length	11 mm 0.432 in
	Flexible with non insulated ferrule	0.22 ... 4 mm ²	24 ... 12 AWG		
	Flexible with insulated ferrule	0.22 ... 4 mm ²	24 ... 12 AWG		
Gauge		A3-B3		Tool	Flat screwdriver Ø 3.5 mm Ø 0.138 in
2 conductors per clamp	Rigid: Solid/Stranded	0.2 ... 2.5 mm ²	24 ... 14 AWG		
	Flexible without ferrule	0.2 ... 2.5 mm ²	24 ... 14 AWG		
Flexible with twin ferrule		0.22 ... 2.5 mm ²	24 ... 14 AWG	Torque	0.6 Nm ± 0.1 5.31 lb.in ± 0.885
Rated current / Rated cross section		6.3 A / 4 mm ²	10 A / 10 AWG		
Rated voltage		630 V	300 V		
Impulse withstand voltage		8000 V			
Protection		IP20	NEMA 1		

Separate arrangement		Assembly composed of 1 fuse terminal block in between non fuse terminal blocks	Overload and short-circuit protection	2.5 W
			Exclusive short-circuit protection	4 W
Compound arrangement		Assembly composed of 5 fuse terminal blocks	Overload and short-circuit protection	1.6 W
			Exclusive short-circuit protection	4 W

The connecting capacity data for one Rigid: Solid/Stranded, or one Flexible conductor (when applicable) is a mandatory information required by IEC, UL and CSA standards (Copper conductors). All other data are provided as supplementary information only. For more details, please consult our CB, UL or CSA certificates and technical datasheet available on <http://www.TE.com>

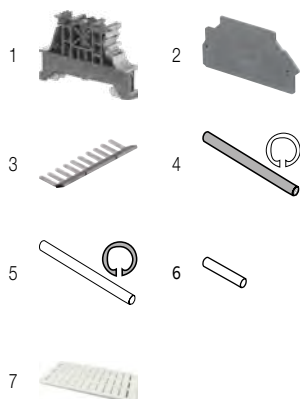
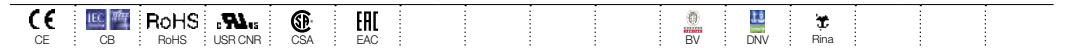

Accessories

Description	Color	Type	Part Number	Pkg qty	Weight (1 pce) g	
1 End stops 10 mm 0.394 in	Dark grey	BAM4	1SNK900001R0000	50	14.00	
2 End sections 1.5 mm 0.059 in	Dark grey	ES4-SF	1SNK508960R0000	20	1.80	
3 Lateral jumper bars 10 poles 35 A (IEC)	Grey	PC81-10	1SNA173523R1100	10	5.00	
4 Assembly rods		2 poles	TGA8	1SNA168672R1100	10	1.00
		3 poles	TGA8	1SNA168673R1200	10	1.50
		4 poles	TGA8	1SNA168674R1300	10	2.00
5 Spring retaining Rings		ANT	1SNA168675R1400	10		
6 Neutral cartridge 5x25		CN5	1SNA179371R1600	10	3.9	
7 Terminal block markers	White	Blank marker	MG-CPM 13 41791	1SNB041791R0612	1680	0.27
		Blank card	MC812	1SNK160000R0000	22	10.00
			MC812PA	1SNK169999R0000	20	14.00
Universal wire markers holder	Grey	UMH	1SNK900611R0000	10	0.20	

Complete list of accessories is indicated in the terminal block datasheet including end stops. Some accessories such as jumper bars may modify the terminal block's ratings. Complete information available in the accessories section of the catalog.

Technical data valid for copper conductors only.

ZS4-SF1-R screw clamp terminal blocks

For 5 x 20 and 5 x 25 fuses - with blown fuse indicator - 8 mm 0.315 in spacing

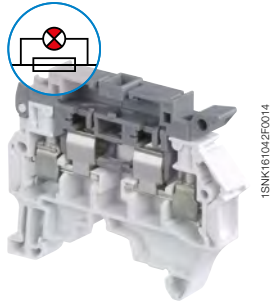
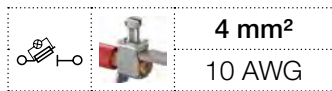

ZS4-SF1-R

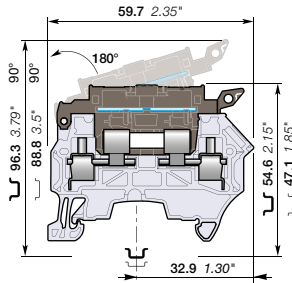

8 mm 0.315 in spacing

Description

- Protect your circuit with 5x25 and 5x20 fuse terminal blocks (fuse not supplied with the terminal blocks),
- Compliant with IEC 60947-7-3 standard,
- Quickly identify the defective circuit thanks to the blown fuse indicator (with leakage current < 0.5 mA).

Ordering details

Description	Color	Type	Part Number	Pkg qty	Weight (1 pce) g
Fuse With blown fuse indicator 115 ... 250 V AC / DC	Grey, dark grey	ZS4-SF1-R3	1SNK508414R0000	50	13.30
With blown fuse indicator 24 ... 110 V AC / DC		ZS4-SF1-R1	1SNK508412R0000	50	13.30

Main technical data

Connecting capacity	IEC	UL - CSA	Mounting instructions
1 conductor per clamp	Rigid: Solid/Stranded Flexible without ferrule Flexible with non insulated ferrule Flexible with insulated ferrule Gauge	0.2 ... 4 mm ² 0.22 ... 4 mm ² 0.22 ... 4 mm ² 0.22 ... 4 mm ² A3-B3	24 ... 10 AWG 24 ... 12 AWG 24 ... 12 AWG
2 conductors per clamp	Rigid: Solid/Stranded Flexible without ferrule Flexible with twin ferrule	0.2 ... 2.5 mm ² 0.2 ... 2.5 mm ² 0.22 ... 2.5 mm ²	24 ... 14 AWG 24 ... 14 AWG 24 ... 14 AWG
Rated current / Rated cross section		6.3 A / 4 mm ²	10 A / 10 AWG
Rated voltage	630 V	300 V	
Impulse withstand voltage	8000 V		
Protection	IP20	NEMA 1	

Separate arrangement		Assembly composed of 1 fuse terminal block in between non fuse terminal blocks	Overload and short-circuit protection	2.5 W
Compound arrangement		Assembly composed of 5 fuse terminal blocks	Exclusive short-circuit protection	4 W
			Overload and short-circuit protection	1.6 W
			Exclusive short-circuit protection	4 W

The connecting capacity data for one Rigid: Solid/Stranded, or one Flexible conductor (when applicable) is a mandatory information required by IEC, UL and CSA standards (Copper conductors). All other data are provided as supplementary information only. For more details, please consult our CB, UL or CSA certificates and technical datasheet available on <http://www.TE.com>

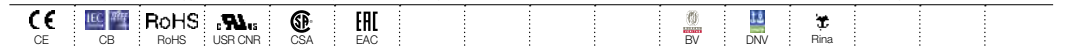

Accessories

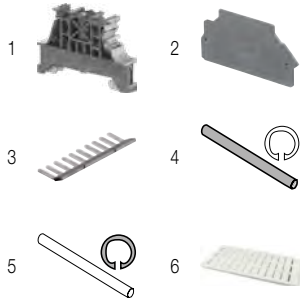

Description	Color	Type	Part Number	Pkg qty	Weight (1 pce) g
1 End stops	Dark grey	BAM4	1SNK900001R0000	50	14.00
2 End sections	Dark grey	ES4-SF	1SNK508960R0000	20	1.80
3 Lateral jumper bars	Grey	PC81-10	1SNA173523R1100	10	5.00
4 Assembly rods		TGA8	1SNA168672R1100	10	1.00
		TGA8	1SNA168673R1200	10	1.50
		TGA8	1SNA168674R1300	10	2.00
5 Spring retaining Rings		ANT	1SNA168675R1400	10	
6 Terminal block markers	White	MG-CPM 13 41791	1SNB041791R0612	1680	0.27
		MC812	1SNK160000R0000	22	10.00
		MC812PA	1SNK169999R0000	20	14.00
	Universal wire markers holder	Grey	UMH	1SNK900611R0000	10

Complete list of accessories is indicated in the terminal block datasheet including end stops. Some accessories such as jumper bars may modify the terminal block's ratings: Complete information available in the accessories section of the catalog.

Technical data valid for copper conductors only.

ZS4-SF1-R screw clamp terminal blocks

For 5 x 20 and 5 x 25 fuses - with blown fuse indicator and test sockets - 8 mm 0.315 in spacing

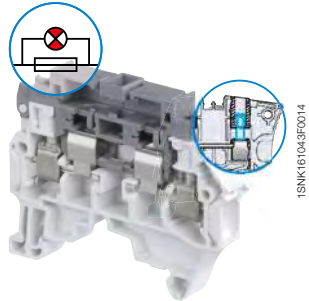

ZS4-SF1-R

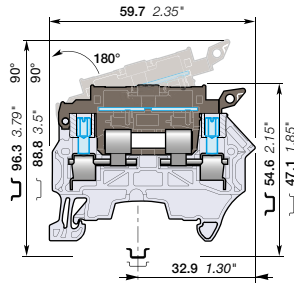

8 mm 0.315 in spacing

Description

- Protect your circuit with 5x25 and 5x20 fuse terminal blocks (fuse not supplied with the terminal blocks),
- Compliant with IEC 60947-7-3 standard,
- Ease the test with built-in test sockets,
- Quickly identify the defective circuit thanks to the blown fuse indicator (with leakage current < 0.5 mA).

Ordering details

Description	Color	Type	Part Number	Pkg qty	Weight (1 pce) g
Fuse With blown fuse indicator 115 ... 250 V AC / DC and 2 test sockets DIA 2 mm 0.079 in	Grey, dark grey	ZS4-SF1-R4	1SNK508415R0000	50	13.30
With blown fuse indicator 24 ... 110 V AC / DC and 2 test sockets DIA 2 mm 0.079 in		ZS4-SF1-R2	1SNK508413R0000	50	13.30

Main technical data

Connecting capacity	IEC	UL - CSA	Mounting instructions		
1 conductor per clamp	Rigid: Solid/Stranded	0.2 ... 4 mm ²	24 ... 10 AWG	Rail	TH 35-7.5, TH 35-15
	Flexible without ferrule	0.22 ... 4 mm ²		Wire stripping length	11 mm 0.432 in
	Flexible with non insulated ferrule	0.22 ... 4 mm ²	24 ... 12 AWG	Tool	Flat screwdriver Ø 3.5 mm Ø 0.138 in
	Flexible with insulated ferrule	0.22 ... 4 mm ²	24 ... 12 AWG		
	Gauge	A3-B3		Torque	0.6 Nm ± 0.1 5.31 lb.in ± 0.885
2 conductors per clamp	Rigid: Solid/Stranded	0.2 ... 2.5 mm ²	24 ... 14 AWG		
	Flexible without ferrule	0.2 ... 2.5 mm ²			
	Flexible with twin ferrule	0.22 ... 2.5 mm ²	24 ... 14 AWG		
Rated current / Rated cross section		6.3 A / 4 mm ²	10 A / 10 AWG		
Rated voltage		630 V	300 V		
Impulse withstand voltage		8000 V			
Protection		IP20	NEMA 1		

Separate arrangement		Assembly composed of 1 fuse terminal block in between non fuse terminal blocks	Overload and short-circuit protection	2.5 W
			Exclusive short-circuit protection	4 W
Compound arrangement		Assembly composed of 5 fuse terminal blocks	Overload and short-circuit protection	1.6 W
			Exclusive short-circuit protection	4 W

The connecting capacity data for one Rigid: Solid/Stranded, or one Flexible conductor (when applicable) is a mandatory information required by IEC, UL and CSA standards (Copper conductors). All other data are provided as supplementary information only. For more details, please consult our CB, UL or CSA certificates and technical datasheet available on <http://www.TE.com>

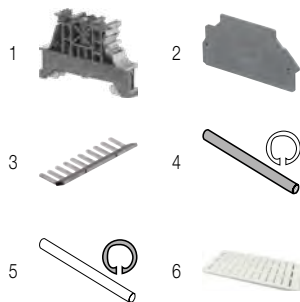
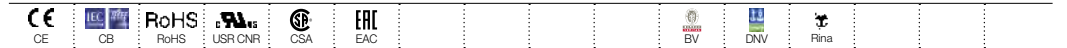

Accessories

Description	Color	Type	Part Number	Pkg qty	Weight (1 pce) g	
1 End stops 10 mm 0.394 in	Dark grey	BAM4	1SNK90001R0000	50	14.00	
2 End sections 1.5 mm 0.059 in	Dark grey	ES4-SF	1SNK508960R0000	20	1.80	
3 Lateral jumper bars 10 poles 35 A (IEC)	Grey	PC81-10	1SNA173523R1100	10	5.00	
4 Assembly rods		TGA8	1SNA168672R1100	10	1.00	
		TGA8	1SNA168673R1200	10	1.50	
		TGA8	1SNA168674R1300	10	2.00	
5 Spring retaining Rings		ANT	1SNA168675R1400	10		
6 Terminal block markers	Blank marker	White	MG-CPM 13 41791	1SNB041791R0612	1680	0.27
	Blank card		MC812	1SNK160000R0000	22	10.00
			MC812PA	1SNK169999R0000	20	14.00
	Universal wire markers holder	Grey	UMH	1SNK900611R0000	10	0.20

Complete list of accessories is indicated in the terminal block datasheet including end stops.

Some accessories such as jumper bars may modify the terminal block's ratings: Complete information available in the accessories section of the catalog.

Technical data valid for copper conductors only.

ZS4-R1 screw clamp terminal blocks

Feed-through - 8 mm 0.315 in spacing



1SNK161048FC014

ZS4-R1

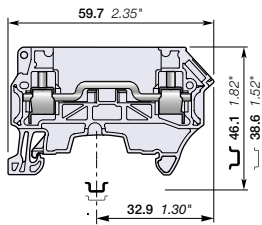

8 mm 0.315 in spacing

Description

Simplify the alternated feed-through and fuse circuits operations:

- With the same profile as the ZS4-SF1, the wiring of the alternated feed-through and fuse circuits is easier.

Ordering details

Description	Color	Type	Part Number	Pkg qty	Weight (1 pce) g
Feed-through Profile aligned with ZS4-SF1	Grey <input type="checkbox"/>	ZS4-R1	1SNK508013R0000	50	11.00

Main technical data

Connecting capacity		IEC	UL - CSA	Mounting instructions		
1 conductor per clamp		Rigid: Solid/Stranded Flexible without ferrule Flexible with non insulated ferrule Flexible with insulated ferrule Gauge	0.2 ... 4 mm ² 0.22 ... 4 mm ² 0.22 ... 4 mm ² 0.22 ... 4 mm ² A3-B3	24 ... 10 AWG 24 ... 12 AWG 24 ... 12 AWG	Rail Wire stripping length	TH 35-7.5, TH 35-15 11 mm 0.432 in
2 conductors per clamp		Rigid: Solid/Stranded Flexible without ferrule Flexible with twin ferrule	0.2 ... 2.5 mm ² 0.2 ... 2.5 mm ² 0.22 ... 2.5 mm ²	24 ... 14 AWG 24 ... 14 AWG 24 ... 14 AWG	Tool	Flat screwdriver Ø 3.5 mm Ø 0.138 in
Rated current / Rated cross section		24 A / 2.5 mm ²	26 A / 10 AWG	Torque		0.6 Nm ± 0.1 5.31 lb.in ± 0.885
Rated short-time withstand current (1s)		300 A				
Short Circuit Current Rating (with specific conditions)						
Rated voltage		800 V	300 V			
Impulse withstand voltage		6000 V				
Protection		IP20	NEMA 1			

The connecting capacity data for one Rigid: Solid/Stranded, or one Flexible conductor (when applicable) is a mandatory information required by IEC, UL and CSA standards (Copper conductors). All other data are provided as supplementary information only. For more details, please consult our CB, UL or CSA certificates and technical datasheet available on <http://www.TE.com>

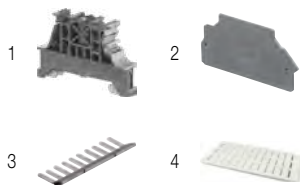

Accessories

Description	Color	Type	Part Number	Pkg qty	Weight (1 pce) g
1 End stops 10 mm 0.394 in	Dark grey <input checked="" type="checkbox"/>	BAM4	1SNK900001R0000	50	14.00
2 End sections 1.5 mm 0.059 in	Dark grey <input checked="" type="checkbox"/>	ES4-SF	1SNK508960R0000	20	1.80
3 Lateral jumper bars 10 poles 35 A (IEC)	Grey <input type="checkbox"/>	PC81-10	1SNA173523R1100	10	5.00
4 Terminal block markers	White <input type="checkbox"/>	MG-CPM 13 41791	1SNB041791R0612	1680	0.27
		MC812	1SNK160000R0000	22	10.00
		MC812PA	1SNK169999R0000	20	14.00
Universal wire markers holder	Grey <input type="checkbox"/>	UMH	1SNK900611R0000	10	0.20

Complete list of accessories is indicated in the terminal block datasheet including end stops.

Some accessories such as jumper bars may modify the terminal block's ratings. Complete information available in the accessories section of the catalog.

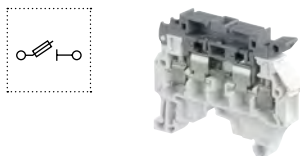

Fuse screw clamp terminal blocks

Description	Color	Type	Part Number	Pkg qty	Weight (1 pce) g
Fuse	Grey, dark grey <input type="checkbox"/>	ZS4-SF1	1SNK508410R0000	50	13.30

Technical data valid for copper conductors only.

ZS4-S-R3 screw clamp terminal blocks

Disconnect with lever - 8 mm 0.315 in spacing

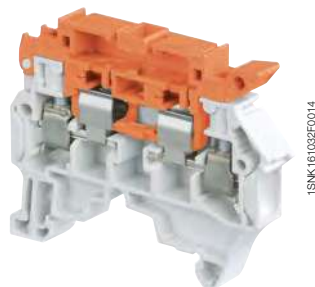
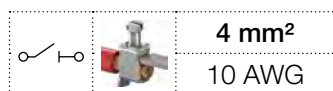

ZS4-S-R3

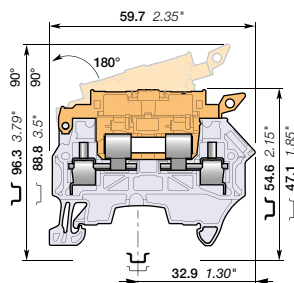

8 mm 0.315 in spacing

Description

Simplify the disconnect operations for the disconnect terminal blocks installed next to fuse terminal blocks ZS4-SF1:

- With the same profile as ZS4-SF1, the ZS4-S-R3 disconnect lever is easily operated by hand and the wiring of the alternated disconnect and fuse circuits is easier,.
- Neutral cartridge CN5 5x25 included.

Ordering details

Description	Color	Type	Part Number	Pkg qty	Weight (1 pce) g
Disconnect Profile aligned with ZS4-SF1	Grey, orange	ZS4-S-R3	1SNK508416R0000	50	13.30
	Grey, blue	ZS4-S-R3-T2	1SNK508419R0000	50	13.30

Main technical data

Connecting capacity		IEC	UL - CSA	Mounting instructions	
1 conductor per clamp	Rigid: Solid/Stranded	0.2 ... 4 mm²	24 ... 10 AWG	Rail	TH 35-7.5, TH 35-15
	Flexible without ferrule	0.22 ... 4 mm²		Wire stripping length	11 mm 0.432 in
	Flexible with non insulated ferrule	0.22 ... 4 mm²	24 ... 12 AWG		
	Flexible with insulated ferrule	0.22 ... 4 mm²	24 ... 12 AWG		
Gauge		A3-B3			
2 conductors per clamp	Rigid: Solid/Stranded	0.2 ... 2.5 mm²	24 ... 14 AWG	Tool	Flat screwdriver Ø 3.5 mm Ø 0.138 in
	Flexible without ferrule	0.2 ... 2.5 mm²			
	Flexible with twin ferrule	0.22 ... 2.5 mm²	24 ... 14 AWG		
Rated current / Rated cross section		18 A / 2.5 mm²	18 A / 10 AWG	Torque	0.6 Nm ± 0.1 5.31 lb.in ± 0.885
Maximum current / Maximum cross section		18 A / 4 mm²			
Rated short-time withstand current (1s)		300 A			
Rated voltage		630 V	300 V		
Impulse withstand voltage		6000 V			
Protection		IP20	NEMA 1		

Recommendation for best usage: in horizontal assemblies, disconnect terminal blocks should be mounted with fixed foot on top (power side) so that the disconnect lever does not partially close through gravity. Furthermore, as specified per IEC 60947-7-1, disconnect terminal blocks are intended to be used for temporary disconnection at zero potential and at no load.

The connecting capacity data for one Rigid: Solid/Stranded, or one Flexible conductor (when applicable) is a mandatory information required by IEC, UL and CSA standards (Copper conductors). All other data are provided as supplementary information only. For more details, please consult our CB, UL or CSA certificates and technical datasheet available on <http://www.TE.com>

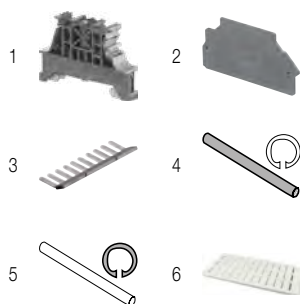
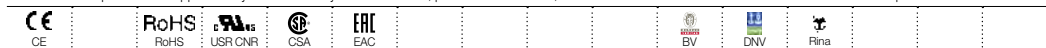

Accessories

Description	Color	Type	Part Number	Pkg qty	Weight (1 pce) g	
1 End stops 10 mm 0.394 in	Dark grey	BAM4	1SNK900001R0000	50	14.00	
2 End sections 1.5 mm 0.059 in	Dark grey	ES4-SF	1SNK508960R0000	20	1.80	
3 Lateral jumper bars 10 poles 35 A (IEC)	Grey	PC81-10	1SNA173523R1100	10	5.00	
4 Assembly rods		2 poles	TGA8	1SNA168672R1100	10	1.00
		3 poles	TGA8	1SNA168673R1200	10	1.50
		4 poles	TGA8	1SNA168674R1300	10	2.00
5 Spring retaining Rings		ANT	1SNA168675R1400	10		
6 Terminal block markers	White	Blank marker	MG-OPM 13 41791	1SNB041791R0612	1680	0.27
		Blank card	MC812	1SNK160000R0000	22	10.00
			MC812PA	1SNK169999R0000	20	14.00
		Universal wire markers holder	UMH	1SNK900611R0000	10	0.20

Complete list of accessories is indicated in the terminal block datasheet including end stops.

Some accessories such as jumper bars may modify the terminal block's ratings: Complete information available in the accessories section of the catalog.

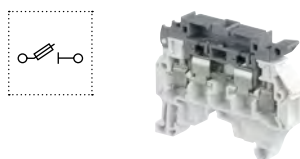

Fuse screw clamp terminal blocks

Description	Color	Type	Part Number	Pkg qty	Weight (1 pce) g
Fuse	Grey, dark grey	ZS4-SF1	1SNK508410R0000	50	13.30

Technical data valid for copper conductors only.

ZS4-SF screw clamp terminal blocks

For 5 x 20 fuses - 6 mm 0.236 in spacing



ZS4-SF

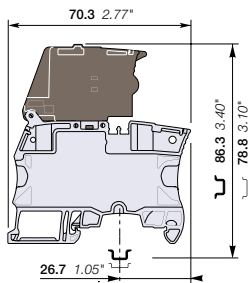

6 mm 0.236 in spacing

Description

- Protect your circuits with 5x20 fuse terminal blocks compliant with IEC 60947-7-3 standard (fuse not supplied with the terminal blocks),
- Simplify the distribution thanks to the two jumper channels aligned with ZS4 or ZS4-R2 feed-through and ZS4-S-R1 disconnect terminal blocks.

Ordering details

Description	Color	Type	Part Number	Pkg qty	Weight (1 pce) g
Fuse	Grey, dark grey	ZS4-SF	1SNK506410R0000	50	18.60

Main technical data

Connecting capacity		IEC	UL - CSA	Mounting instructions	
1 conductor per clamp	Rigid: Solid/Stranded	0.2 ... 4 mm ²	24 ... 10 AWG	Rail	TH 35-7.5, TH 35-15
	Flexible without ferrule	0.22 ... 4 mm ²	24 ... 12 AWG	Wire stripping length	10.5 mm 0.412 in
	Flexible with non insulated ferrule	0.22 ... 4 mm ²	24 ... 12 AWG		
	Flexible with insulated ferrule	0.22 ... 4 mm ²	24 ... 12 AWG		
Gauge		A3-B3		Tool	Flat screwdriver Ø 3.5 mm Ø 0.138 in
2 conductors per clamp	Rigid: Solid/Stranded	0.2 ... 1.5 mm ²	24 ... 16 AWG	Torque	0.6 Nm ± 0.1 5.31 lb.in ± 0.885
	Flexible without ferrule	0.2 ... 1.5 mm ²	24 ... 16 AWG		
Flexible with twin ferrule		0.22 ... 1.5 mm ²	24 ... 16 AWG		
Rated current / Rated cross section		6.3 A / 4 mm ²	10 A / 10 AWG		
Rated voltage		500 V	150 V		
Impulse withstand voltage		6000 V			
Protection		IP20	NEMA 1		

Mount your fuse safely without touching any active part: put the fuse into the hooks of the fuse holder shutter; at the closing of the shutter, the fuse is perfectly in place in the fuse holder.

Separate arrangement		Assembly composed of 1 fuse terminal block in between non fuse terminal blocks	Overload and short-circuit protection	2.5 W
			Exclusive short-circuit protection	4 W
Compound arrangement		Assembly composed of 5 fuse terminal blocks	Overload and short-circuit protection	2.5 W
			Exclusive short-circuit protection	4 W

The connecting capacity data for one Rigid: Solid/Stranded, or one Flexible conductor (when applicable) is a mandatory information required by IEC, UL and CSA standards (Copper conductors). All other data are provided as supplementary information only. For more details, please consult our CB, UL or CSA certificates and technical datasheet available on <http://www.TE.com>

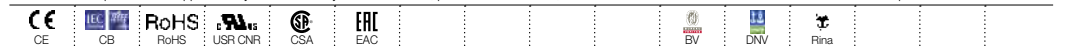

Accessories

Description	Color	Type	Part Number	Pkg qty	Weight (1 pce) g
1 End stops	Dark grey	BAM4	1SNK900001R0000	50	14.00
2 Jumper bars	Orange	JB6-2	1SNK906302R0000	50	1.30
		JB6-3	1SNK906303R0000	50	2.10
		JB6-4	1SNK906304R0000	50	2.90
		JB6-5	1SNK906305R0000	50	3.60
		JB6-10	1SNK906310R0000	20	7.40
3 Test adapters	Dark grey	TP2	1SNK900203R0000	20	1.70
		TP4	1SNK900205R0000	20	2.40
4 Test connectors	Dark grey	TC5-R1	1SNK900201R0000	10	5.20
5 Spacers	Dark grey	ES-TC6	1SNK900105R0000	10	0.80
6 Terminal block markers	White	MG-CPM 13 41791	1SNB041791R0612	1680	0.27
		MC612	1SNK150000R0000	22	10.00
		MC612PA	1SNK159999R0000	20	11.00
	Universal wire markers holder	Grey	UMH	1SNK900611R0000	10

Complete list of accessories is indicated in the terminal block datasheet including end stops. Some accessories such as jumper bars may modify the terminal block's ratings: Complete information available in the accessories section of the catalog.

Technical data valid for copper conductors only.

ZS4-SF-T screw clamp terminal blocks

For 5 x 20 fuses - with test socket - 6 mm 0.236 in spacing

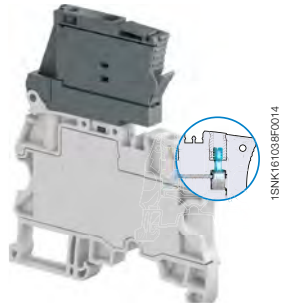
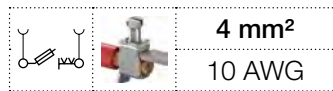

ZS4-SF-T

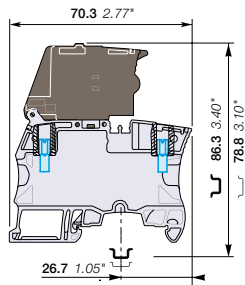

6 mm 0.236 in spacing

Description

- Protect your circuits with 5x20 fuse terminal blocks compliant with IEC 60947-7-3 standard (fuse not supplied with the terminal blocks),
- Simplify the distribution thanks to the two jumper channels aligned with ZS4 or ZS4-R2 feed-through and ZS4-S-R1 disconnect terminal blocks,
- Ease the test with built-in test socket screws.

Ordering details

Description	Color	Type	Part Number	Pkg qty	Weight (1 pce) g
Fuse With 2 test sockets DIA 2 mm 0.079 in	Grey, dark grey	ZS4-SF-T2	1SNK506411R0000	50	18.60

Main technical data

Connecting capacity		IEC	UL - CSA	Mounting instructions	
1 conductor per clamp	Rigid: Solid/Stranded	0.2 ... 4 mm ²	24 ... 10 AWG	Rail	TH 35-7.5, TH 35-15
	Flexible without ferrule	0.22 ... 4 mm ²		Wire stripping length	10.5 mm 0.412 in
	Flexible with non insulated ferrule	0.22 ... 4 mm ²	24 ... 12 AWG		
	Flexible with insulated ferrule	0.22 ... 4 mm ²	24 ... 12 AWG		
2 conductors per clamp	Gauge	A3-B3		Tool	Flat screwdriver Ø 3.5 mm Ø 0.138 in
	Rigid: Solid/Stranded	0.2 ... 1.5 mm ²	24 ... 16 AWG		
	Flexible without ferrule	0.2 ... 1.5 mm ²	24 ... 16 AWG		
	Flexible with twin ferrule	0.22 ... 1.5 mm ²	24 ... 16 AWG		
Rated current / Rated cross section		6.3 A / 4 mm ²	10 A / 10 AWG	Torque	0.6 Nm ± 0.1 5.31 lb.in ± 0.885
Rated voltage		500 V	150 V		
Impulse withstand voltage		6000 V			
Protection		IP20	NEMA 1		

Mount your fuse safely without touching any active part: put the fuse into the hooks of the fuse holder shutter; at the closing of the shutter, the fuse is perfectly in place in the fuse holder.

Separate arrangement		Assembly composed of 1 fuse terminal block in between non fuse terminal blocks	Overload and short-circuit protection	2.5 W
			Exclusive short-circuit protection	4 W
Compound arrangement		Assembly composed of 5 fuse terminal blocks	Overload and short-circuit protection	2.5 W
			Exclusive short-circuit protection	4 W

The connecting capacity data for one Rigid: Solid/Stranded, or one Flexible conductor (when applicable) is a mandatory information required by IEC, UL and CSA standards (Copper conductors). All other data are provided as supplementary information only. For more details, please consult our CB, UL or CSA certificates and technical datasheet available on <http://www.TE.com>

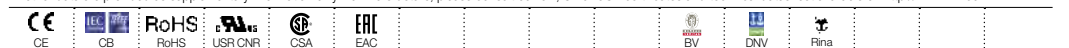

Accessories

Description	Color	Type	Part Number	Pkg qty	Weight (1 pce) g	
1 End stops	Dark grey	BAM4	1SNK900001R0000	50	14.00	
2 Jumper bars	Orange	2 poles	JB6-2	1SNK906302R0000	50	1.30
		3 poles	JB6-3	1SNK906303R0000	50	2.10
		4 poles	JB6-4	1SNK906304R0000	50	2.90
		5 poles	JB6-5	1SNK906305R0000	50	3.60
		10 poles	JB6-10	1SNK906310R0000	20	7.40
3 Test connectors	Dark grey	TC5-R1	1SNK900201R0000	10	5.20	
4 Spacers	Dark grey	ES-TC6	1SNK900105R0000	10	0.80	
5 Terminal block markers	White	Blank marker	MG-CPM 13 41791	1SNB041791R0612	1680	0.27
		Blank card	MC612	1SNK150000R0000	22	10.00
			MC612PA	1SNK159999R0000	20	11.00
	Universal wire markers holder	Grey	UMH	1SNK900611R0000	10	0.20

Complete list of accessories is indicated in the terminal block datasheet including end stops.

Some accessories such as jumper bars may modify the terminal block's ratings: Complete information available in the accessories section of the catalog.

Technical data valid for copper conductors only.

ZS4-SF-R screw clamp terminal blocks

For 5 x 20 fuses - with blown fuse indicator - 6 mm 0.236 in spacing

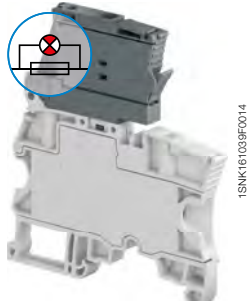

ZS4-SF-R

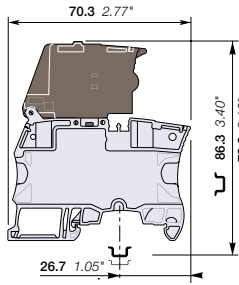

6 mm 0.236 in spacing

Description

- Protect your circuits with 5x20 fuse terminal blocks compliant with IEC 60947-7-3 standard (fuse not supplied with the terminal blocks),
- Simplify the distribution thanks to the two jumper channels aligned with ZS4 or ZS4-R2 feed-through and ZS4-S-R1 disconnect terminal blocks,
- Quickly identify the defective circuit thanks to the blown fuse indicator (with leakage current < 0.5 mA).

Ordering details

Description	Color	Type	Part Number	Pkg qty	Weight (1 pce) g
Fuse With blown fuse indicator 115 ... 250 V AC / DC	Grey, dark grey	ZS4-SF-R3	1SNK506415R0000	50	18.60
With blown fuse indicator 24 ... 110 V AC / DC		ZS4-SF-R1	1SNK506412R0000	50	18.60

Main technical data

Connecting capacity		IEC	UL - CSA	Mounting instructions	
1 conductor per clamp	Rigid: Solid/Stranded	0.2 ... 4 mm ²	24 ... 10 AWG	Rail	TH 35-7.5, TH 35-15
	Flexible without ferrule	0.22 ... 4 mm ²		Wire stripping length	10.5 mm 0.412 in
	Flexible with non insulated ferrule	0.22 ... 4 mm ²	24 ... 12 AWG	Tool	Flat screwdriver Ø 3.5 mm Ø 0.138 in
	Flexible with insulated ferrule	0.22 ... 4 mm ²	24 ... 12 AWG		
Gauge		A3-B3		Torque	0.6 Nm ± 0.1 5.31 lb.in ± 0.885
2 conductors per clamp	Rigid: Solid/Stranded	0.2 ... 1.5 mm ²	24 ... 16 AWG		
	Flexible without ferrule	0.2 ... 1.5 mm ²			
	Flexible with twin ferrule	0.22 ... 1.5 mm ²	24 ... 16 AWG		
Rated current / Rated cross section		6.3 A / 4 mm ²	10 A / 10 AWG		
Rated voltage		500 V	150 V		
Impulse withstand voltage		6000 V			
Protection		IP20	NEMA 1		

Mount your fuse safely without touching any active part: put the fuse into the hooks of the fuse holder shutter; at the closing of the shutter, the fuse is perfectly in place in the fuse holder.

Separate arrangement		Assembly composed of 1 fuse terminal block in between non fuse terminal blocks	Overload and short-circuit protection	2.5 W
			Exclusive short-circuit protection	4 W
Compound arrangement		Assembly composed of 5 fuse terminal blocks	Overload and short-circuit protection	2.5 W
			Exclusive short-circuit protection	4 W

The connecting capacity data for one Rigid: Solid/Stranded, or one Flexible conductor (when applicable) is a mandatory information required by IEC, UL and CSA standards (Copper conductors). All other data are provided as supplementary information only. For more details, please consult our CB, UL or CSA certificates and technical datasheet available on <http://www.TE.com>

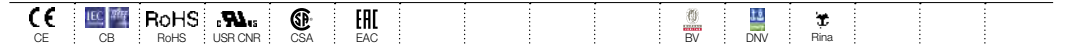

Accessories



Description	Color	Type	Part Number	Pkg qty	Weight (1 pce) g
1 End stops	Dark grey	BAM4	1SNK900001R0000	50	14.00
2 Jumper bars	Orange	JB6-2	1SNK906302R0000	50	1.30
		JB6-3	1SNK906303R0000	50	2.10
		JB6-4	1SNK906304R0000	50	2.90
		JB6-5	1SNK906305R0000	50	3.60
		JB6-10	1SNK906310R0000	20	7.40
3 Test adapters	Dark grey	TP2	1SNK900203R0000	20	1.70
		TP4	1SNK900205R0000	20	2.40
4 Test connectors	Dark grey	TC5-R1	1SNK900201R0000	10	5.20
5 Spacers	Dark grey	ES-TC6	1SNK900105R0000	10	0.80
6 Terminal block markers	White	MG-CPM 13 41791	1SNB041791R0612	1680	0.27
		MC612	1SNK150000R0000	22	10.00
		MC612PA	1SNK159999R0000	20	11.00
	Universal wire markers holder	Grey	UMH	1SNK900611R0000	10

Complete list of accessories is indicated in the terminal block datasheet including end stops. Some accessories such as jumper bars may modify the terminal block's ratings: Complete information available in the accessories section of the catalog.

Technical data valid for copper conductors only.

ZS4-SF-R screw clamp terminal blocks

For 5 x 20 fuses - with blown fuse indicator and test sockets - 6 mm 0.236 in spacing

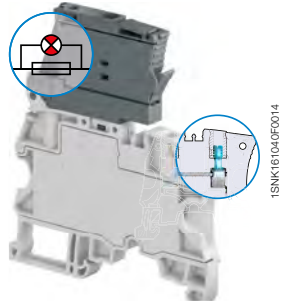

ZS4-SF-R

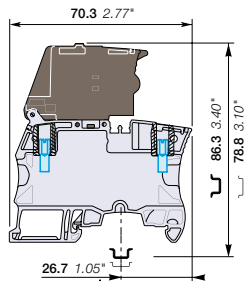

6 mm 0.236 in spacing

Description

- Protect your circuits with 5x20 fuse terminal blocks compliant with IEC 60947-7-3 standard (fuse not supplied with the terminal blocks),
- Simplify the distribution thanks to the two jumper channels aligned with ZS4 or ZS4-R2 feed-through and ZS4-S-R1 disconnect terminal blocks,
- Ease the test with built-in test socket screws,
- Quickly identify the defective circuit thanks to the blown fuse indicator (with leakage current < 0.5 mA).

Ordering details

Description	Color	Type	Part Number	Pkg qty	Weight (1 pce) g
Fuse With blown fuse indicator 115 ... 250 V AC / DC and 2 test sockets DIA 2 mm 0.079 in	Grey, dark grey	ZS4-SF-R4	1SNK506416R0000	50	18.60
With blown fuse indicator 24 ... 110 V AC / DC and 2 test sockets DIA 2 mm 0.079 in		ZS4-SF-R2	1SNK506413R0000	50	18.60

Main technical data

Connecting capacity	IEC	UL - CSA	Rail	Wire stripping length	Tool	Torque
1 conductor per clamp	Rigid: Solid/Stranded Flexible without ferrule Flexible with non insulated ferrule Flexible with insulated ferrule Gauge	0.2 ... 4 mm² 0.22 ... 4 mm² 0.22 ... 4 mm² 0.22 ... 4 mm² A3-B3	24 ... 10 AWG	TH 35-7.5, TH 35-15	10.5 mm 0.412 in	
2 conductors per clamp	Rigid: Solid/Stranded Flexible without ferrule Flexible with twin ferrule	0.2 ... 1.5 mm² 0.2 ... 1.5 mm² 0.22 ... 1.5 mm²	24 ... 16 AWG		Flat screwdriver Ø 3.5 mm Ø 0.138 in	
Rated current / Rated cross section		6.3 A / 4 mm²	10 A / 10 AWG			0.6 Nm ± 0.1 5.31 lb.in ± 0.885
Rated voltage		500 V	150 V			
Impulse withstand voltage		6000 V				
Protection		IP20	NEMA 1			

Mounting instructions

Mount your fuse safely without touching any active part: put the fuse into the hooks of the fuse holder shutter; at the closing of the shutter, the fuse is perfectly in place in the fuse holder.

Separate arrangement	Compound arrangement	Protection	Power
Assembly composed of 1 fuse terminal block in between non fuse terminal blocks	Assembly composed of 5 fuse terminal blocks	Overload and short-circuit protection	2.5 W
		Exclusive short-circuit protection	4 W
		Overload and short-circuit protection	2.5 W
		Exclusive short-circuit protection	4 W

The connecting capacity data for one Rigid: Solid/Stranded, or one Flexible conductor (when applicable) is a mandatory information required by IEC, UL and CSA standards (Copper conductors). All other data are provided as supplementary information only. For more details, please consult our CB, UL or CSA certificates and technical datasheet available on <http://www.TE.com>

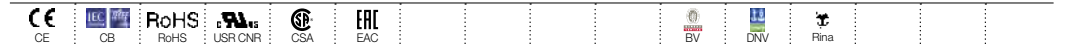

Accessories



Description	Color	Type	Part Number	Pkg qty	Weight (1 pce) g	
1 End stops	Dark grey	BAM4	1SNK900001R0000	50	14.00	
2 Jumper bars	Orange	2 poles	JB6-2	1SNK906302R0000	50	1.30
		3 poles	JB6-3	1SNK906303R0000	50	2.10
		4 poles	JB6-4	1SNK906304R0000	50	2.90
		5 poles	JB6-5	1SNK906305R0000	50	3.60
		10 poles	JB6-10	1SNK906310R0000	20	7.40
		3 Test connectors	Dark grey	TC5-R1	1SNK900201R0000	10
4 Spacers	Dark grey	ES-TC6	1SNK900105R0000	10	0.80	
5 Terminal block markers	White	Blank marker	MG-CPM 13 41791	1SNB041791R0612	1680	0.27
		Blank card	MC612	1SNK150000R0000	22	10.00
		Universal wire markers holder	MC612PA	1SNK159999R0000	20	11.00
	Grey	UMH	1SNK900611R0000	10	0.20	

Complete list of accessories is indicated in the terminal block datasheet including end stops. Some accessories such as jumper bars may modify the terminal block's ratings: Complete information available in the accessories section of the catalog.

Technical data valid for copper conductors only.

ZS4-R2 screw clamp terminal blocks

Feed-through - 6 mm 0.236 in spacing

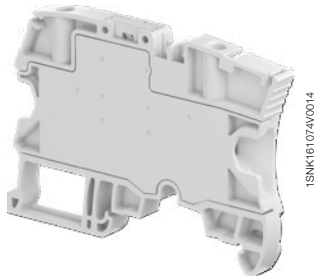

ZS4-R2

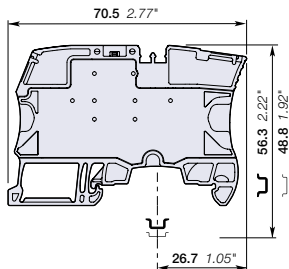

6 mm 0.236 in spacing

Description

- Simplify the distribution of circuits in marshalling cabinets thanks to our feed-through terminal blocks with the same profile as ZS4-SF fuse, ZS4-S-R1 disconnect and ZS4-PE-R2 ground terminal blocks: aligned conductor entries, jumper channels and marking in just 6 mm 0.236 in spacing,
- No end section needed: closed block.

Ordering details

Description	Color	Type	Part Number	Pkg qty	Weight (1 pce) g
Feed-through Profile aligned with ZS4-SF and ZS4-S-R1	Grey <input type="checkbox"/>	ZS4-R2	1SNK506013R0000	50	12.40

Main technical data

Connecting capacity		IEC	UL - CSA	Mounting instructions	
1 conductor per clamp	Rigid: Solid/Stranded	0.2 ... 4 mm ²	24 ... 10 AWG	Rail	TH 35-7.5, TH 35-15
	Flexible without ferrule	0.22 ... 4 mm ²		Wire stripping length	10.5 mm 0.413 in
	Flexible with non insulated ferrule	0.22 ... 4 mm ²	24 ... 12 AWG	Tool	Flat screwdriver Ø 3.5 mm Ø 0.138 in
	Flexible with insulated ferrule	0.22 ... 4 mm ²	24 ... 12 AWG		
Gauge A3-B3				Torque	0.6 Nm ± 0.1 5.31 lb.in ± 0.885
2 conductors per clamp	Rigid: Solid/Stranded	0.2 ... 1.5 mm ²	24 ... 16 AWG		
	Flexible without ferrule	0.2 ... 1.5 mm ²	24 ... 16 AWG		
	Flexible with twin ferrule	0.22 ... 1.5 mm ²	24 ... 16 AWG		
Rated current / Rated cross section		32 A / 4 mm ²	30 A / 10 AWG		
Rated short-time withstand current (1s)		480 A			
Rated voltage		800 V	300 V		
Impulse withstand voltage		8000 V			
Protection		IP20	NEMA 1		

The connecting capacity data for one Rigid: Solid/Stranded, or one Flexible conductor (when applicable) is a mandatory information required by IEC, UL and CSA standards (Copper conductors). All other data are provided as supplementary information only. For more details, please consult our CB, UL or CSA certificates and technical datasheet available on <http://www.TE.com>

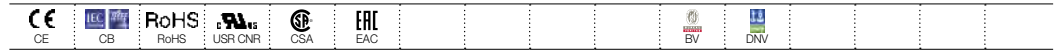

Accessories

Description	Color	Type	Part Number	Pkg qty	Weight (1 pce) g
1 End stops 10 mm 0.394 in	Dark grey <input type="checkbox"/>	BAM4	1SNK900001R0000	50	14.00
2 Jumper bars 2 poles 41 A (IEC)	Orange <input type="checkbox"/>	JB6-2	1SNK906302R0000	50	1.30
		JB6-3	1SNK906303R0000	50	2.10
		JB6-4	1SNK906304R0000	50	2.90
		JB6-5	1SNK906305R0000	50	3.60
		JB6-10	1SNK906310R0000	20	7.40
3 Cross spacing jumpers 3 poles 32 A (IEC)	Orange <input type="checkbox"/>	JB85-3	1SNK900603R0000	10	2.80
4 Test adapters For test plugs DIA 2 mm 0.079 in For test plugs DIA 4 mm 0.157 in	Dark grey <input type="checkbox"/>	TP2	1SNK900203R0000	20	1.70
		TP4	1SNK900205R0000	20	2.40
5 Test connectors End module, 5.2 mm 0.205 in	Dark grey <input type="checkbox"/>	TC5-R1	1SNK900201R0000	10	5.20
6 Spacers 0.8 mm 0.031 in	Dark grey <input type="checkbox"/>	ES-TC6	1SNK900105R0000	10	0.80
7 Terminal block markers Blank marker Blank card Universal wire markers holder	White <input type="checkbox"/>	MG-CPM 13 41791	1SNB041791R0612	1680	0.27
		MC612	1SNK150000R0000	22	10.00
		MC612PA	1SNK159999R0000	20	11.00
	Grey <input type="checkbox"/>	UMH	1SNK900611R0000	10	0.20

Complete list of accessories is indicated in the terminal block datasheet including end stops. Some accessories such as jumper bars may modify the terminal block's ratings: Complete information available in the accessories section of the catalog.



ZS4-SF

ZS4-S-R1

Screw clamp terminal blocks

Description	Color	Type	Part Number	Pkg qty	Weight (1 pce) g
Fuse Profile aligned with ZS4-R2 and ZS4-PE-R2	Grey, dark grey <input type="checkbox"/>	ZS4-SF	1SNK506410R0000	50	18.60
Disconnect Profile aligned with ZS4-R2 and ZS4-PE-R2	Grey <input type="checkbox"/>	ZS4-S-R1	1SNK506310R0000	50	13.20

Technical data valid for copper conductors only.

ZS4-PE-R2 screw clamp terminal blocks

Ground - 6 mm 0.236 in spacing



ZS4-PE-R2

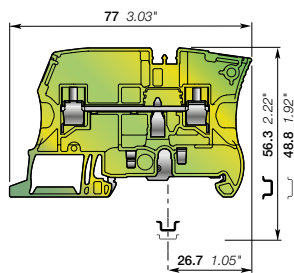

6 mm 0.236 in spacing

Description

Simplify the shielding connection of your analog circuits in marshalling cabinets thanks to our ground terminal blocks with the same profile as ZS4-SF fuse, ZS4-S-R1 disconnect and ZS4-R2 feed-through terminal blocks.

Ordering details

Description	Color	Type	Part Number	Pkg qty	Weight (1 pce) g
Ground Screwless rail connection	Green-yellow	ZS4-PE-R2	1SNK506153R0000	25	15.30

Main technical data

Connecting capacity		IEC	UL - CSA	Mounting instructions	
1 conductor per clamp	Rigid: Solid/Stranded	0.2 ... 4 mm²	24 ... 10 AWG	Rail	TH 35-7.5, TH 35-15
	Flexible without ferrule	0.22 ... 4 mm²	24 ... 12 AWG	Wire stripping length	10.5 mm 0.413 in
	Flexible with non insulated ferrule	0.22 ... 4 mm²	24 ... 12 AWG		
	Flexible with insulated ferrule	0.22 ... 4 mm²	24 ... 12 AWG		
	Gauge	A3-B3		Tool	Flat screwdriver Ø 3.5 mm Ø 0.138 in
Rated cross section		4 mm²	10 AWG	Torque	0.6 Nm ± 0.1 5.31 lb.in ± 0.885
Rated short-time withstand current (1s)		480 A	396 A		
Protection		IP20	NEMA 1		

The connecting capacity data for one Rigid: Solid/Stranded, or one Flexible conductor (when applicable) is a mandatory information required by IEC, UL and CSA standards (Copper conductors). All other data are provided as supplementary information only. For more details, please consult our CB, UL or CSA certificates and technical datasheet available on <http://www.TE.com>

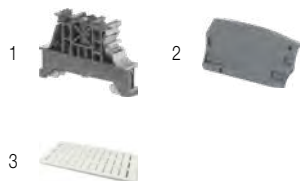

Accessories

Description	Color	Type	Part Number	Pkg qty	Weight (1 pce) g
1 End stops	Dark grey	BAM4	1SNK900001R0000	50	14.00
2 End sections	Dark grey	ES6-4S	1SNK505911R0000	20	3.10
3 Terminal block markers	White	MG-CPM 13 41791	1SNB041791R0612	1680	0.27
		MC612	1SNK150000R0000	22	10.00
		MC612PA	1SNK159999R0000	20	11.00
Universal wire markers holder	Grey	UMH	1SNK900611R0000	10	0.20

Complete list of accessories is indicated in the terminal block datasheet including end stops. Some accessories such as jumper bars may modify the terminal block's ratings: Complete information available in the accessories section of the catalog.



ZS4-SF

ZS4-S-R1

Screw clamp terminal blocks

Description	Color	Type	Part Number	Pkg qty	Weight (1 pce) g
Fuse	Grey, dark grey	ZS4-SF	1SNK506410R0000	50	18.60
Disconnect	Grey	ZS4-S-R1	1SNK506310R0000	50	13.20

Technical data valid for copper conductors only.

ZS4-S-R2 screw clamp terminal blocks

Disconnect with lever - 6 mm 0.236 in spacing

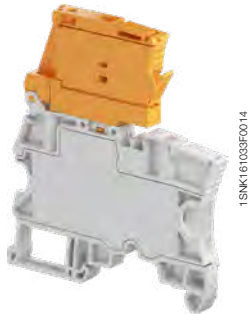

ZS4-S-R2

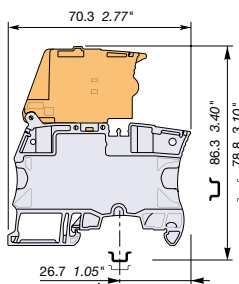

6 mm 0.236 in spacing

Description

Simplify the disconnect operations for the disconnect terminal blocks installed next to fuse terminal blocks ZS4-SF:
 - With the same profile as ZS4-SF, the ZS4-S-R2 disconnect lever is easily operated by hand and the wiring of the alternated disconnect and fuse circuits is easier.

Ordering details

Description	Color	Type	Part Number	Pkg qty	Weight (1 pce) g
Disconnect Profile aligned with ZS4-SF	Grey, orange	ZS4-S-R2	1SNK506414R0000	50	21.6

Main technical data

Connecting capacity		IEC	UL - CSA	Mounting instructions	
1 conductor per clamp	Rigid: Solid/Stranded	0.2 ... 4 mm ²	24 ... 10 AWG	Rail	 TH 35-7.5, TH 35-15
	Flexible without ferrule	0.22 ... 4 mm ²			
	Flexible with non insulated ferrule	0.22 ... 4 mm ²	24 ... 12 AWG	Wire stripping length	 10.5 mm 0.412 in
	Flexible with insulated ferrule	0.22 ... 4 mm ²	24 ... 12 AWG		
Gauge		A3-B3		Tool	 Flat screwdriver Ø 3.5 mm Ø 0.138 in
2 conductors per clamp	Rigid: Solid/Stranded	0.2 ... 1.5 mm ²	24 ... 16 AWG		
	Flexible without ferrule	0.2 ... 1.5 mm ²			
	Flexible with twin ferrule	0.22 ... 1.5 mm ²	24 ... 16 AWG		
Rated current / Rated cross section		18 A / 2.5 mm ²	13 A / 10 AWG	Torque	 0.6 Nm ± 0.1 5.31 lb.in ± 0.885
Maximum current / Maximum cross section		18 A / 4 mm ²			
Rated short-time withstand current (1s)		300 A			
Rated voltage		400 V	150 V		
Impulse withstand voltage		6000 V			
Protection		IP20	NEMA 1		

Recommendation for best usage: in horizontal assemblies, disconnect terminal blocks should be mounted with fixed foot on top (power side) so that the disconnect lever does not partially close through gravity. Furthermore, as specified per IEC 60947-7-1, disconnect terminal blocks are intended to be used for temporary disconnection at zero potential and at no load.

The connecting capacity data for one Rigid: Solid/Stranded, or one Flexible conductor (when applicable) is a mandatory information required by IEC, UL and CSA standards (Copper conductors). All other data are provided as supplementary information only. For more details, please consult our CB, UL or CSA certificates and technical datasheet available on <http://www.TE.com>

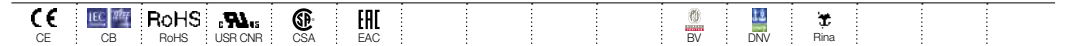

Accessories



Description	Color	Type	Part Number	Pkg qty	Weight (1 pce) g	
1 End stops	Dark grey	BAM4	1SNK900001R0000	50	14.00	
2 Jumper bars	Orange	2 poles	JB6-2	1SNK906302R0000	50	1.30
		3 poles	JB6-3	1SNK906303R0000	50	2.10
		4 poles	JB6-4	1SNK906304R0000	50	2.90
		5 poles	JB6-5	1SNK906305R0000	50	3.60
		10 poles	JB6-10	1SNK906310R0000	20	7.40
3 Test adapters	Dark grey	For test plugs DIA 2 mm 0.079 in	TP2	1SNK900203R0000	20	1.70
		For test plugs DIA 4 mm 0.157 in	TP4	1SNK900205R0000	20	2.40
4 Test connectors	Dark grey	TC5-R1	1SNK900201R0000	10	5.20	
5 Spacers	Dark grey	ES-TC6	1SNK900105R0000	10	0.80	
6 Terminal block markers	White	Blank marker	MG-CPM 13 41791	1SNB041791R0612	1680	0.27
		Blank card	MC612	1SNK150000R0000	22	10.00
			MC612PA	1SNK159999R0000	20	11.00
	Universal wire markers holder	Grey	UMH	1SNK900611R0000	10	0.20

Complete list of accessories is indicated in the terminal block datasheet including end stops.

Some accessories such as jumper bars may modify the terminal block's ratings: Complete information available in the accessories section of the catalog.

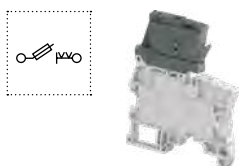

Fuse screw clamp terminal blocks

Description	Color	Type	Part Number	Pkg qty	Weight (1 pce) g
Fuse	Grey, dark grey	ZS4-SF	1SNK506410R0000	50	18.60

Technical data valid for copper conductors only.

ZS10-SF screw clamp terminal blocks

For 6.3x32 fuses - 8 mm 0.315 in spacing

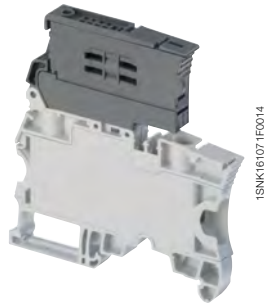

ZS10-SF

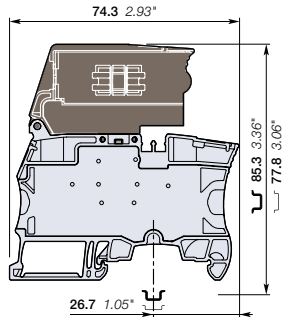

8 mm 0.315 in spacing

Description

- Protect your circuits with 6.3x32 (1/4 x 1/4 in) fuse terminal blocks compliant with IEC 60947-7-3 standard (fuse not supplied with the terminal blocks),
- Simplify the distribution thanks to the two jumper channels.

Ordering details

Description	Color	Type	Part Number	Pkg qty	Weight (1 pce) g
Fuse Closed block	Grey, dark grey	ZS10-SF	1SNK508418R0000	50	28.50

Main technical data

Connecting capacity	IEC	UL - CSA	Rail	Wire stripping length	Tool	Torque
1 conductor per clamp	Rigid: Solid/Stranded	0.5 ... 10 mm ²	24 ... 6 AWG			TH 35-7.5, TH 35-15 13 mm 0.512 in
	Flexible without ferrule	0.5 ... 10 mm ²				
	Flexible with non insulated ferrule	0.5 ... 10 mm ²	24 ... 8 AWG			
	Flexible with insulated ferrule	0.5 ... 6 mm ²	24 ... 10 AWG			
Gauge		A5-B5				
2 conductors per clamp	Rigid: Solid/Stranded	0.5 ... 4 mm ²	20 ... 12 AWG		Flat screwdriver Ø 4 mm Ø 0.157 in	1.3 Nm ± 0.3 11.5 lb.in ± 2.65
	Flexible without ferrule	0.5 ... 4 mm ²	20 ... 12 AWG			
	Flexible with twin ferrule	0.5 ... 4 mm ²	20 ... 12 AWG			
Rated current / Rated cross section		10 A / 10 mm ²	22 A / 6 AWG			
Rated voltage		630 V	600 V			
Impulse withstand voltage		6000 V				
Protection		IP20	NEMA 1			

Mount your fuse safely without touching any active part: put the fuse into the hooks of the fuse holder shutter; at the closing of the shutter, the fuse is perfectly in place in the fuse holder.

Separate arrangement	Compound arrangement	Protection	Power
		Assembly composed of 1 fuse terminal block in between non fuse terminal blocks	Overload and short-circuit protection: 4 W
		Overload and short-circuit protection: 4 W	Exclusive short-circuit protection: 4 W
		Assembly composed of 5 fuse terminal blocks	Overload and short-circuit protection: 2.5 W
		Overload and short-circuit protection: 2.5 W	Exclusive short-circuit protection: 2.5 W

The connecting capacity data for one Rigid: Solid/Stranded, or one Flexible conductor (when applicable) is a mandatory information required by IEC, UL and CSA standards (Copper conductors). All other data are provided as supplementary information only. For more details, please consult our CB, UL or CSA certificates and technical datasheet available on <http://www.TE.com>

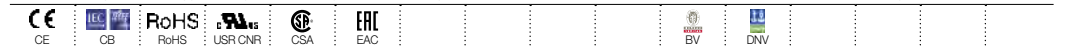

Accessories

Description	Color	Type	Part Number	Pkg qty	Weight (1 pce) g	
1 End stops	Dark grey	BAM4	1SNK900001R0000	50	14.00	
2 Jumper bars	Orange	2 poles	JB8-2	1SNK908302R0000	50	2.70
		3 poles	JB8-3	1SNK908303R0000	50	4.10
		4 poles	JB8-4	1SNK908304R0000	50	5.60
		5 poles	JB8-5	1SNK908305R0000	40	7.00
		10 poles	JB8-10	1SNK908310R0000	20	14.20
3 Test adapters	Dark grey	For test plugs DIA 2 mm 0.079 in	TP2	1SNK900203R0000	20	1.70
		For test plugs DIA 4 mm 0.157 in	TP4	1SNK900205R0000	20	2.40
4 Test connectors	Dark grey	5.2 mm 0.205 in spacing	TC5	1SNK900200R0000	10	5.20
		End module, 5.2 mm 0.205 in	TC5-R1	1SNK900201R0000	10	5.20
5 Spacers	Dark grey	2.8 mm	ES-TC8	1SNK900104R0000	10	1.40
		0.110 in				
6 Terminal block markers	White	Blank marker	MG-CPM 13 41791	1SNB041791R0612	1680	0.27
		Blank card	MC812	1SNK160000R0000	22	10.00
			MC812PA	1SNK169999R0000	20	14.00
		Universal wire markers holder	UMH	1SNK900611R0000	10	0.20

Complete list of accessories is indicated in the terminal block datasheet including end stops. Some accessories such as jumper bars may modify the terminal block's ratings. Complete information available in the accessories section of the catalog.

Technical data valid for copper conductors only.



ZS10-SF-R screw clamp terminal blocks

For 6.3x32 fuses - with blown fuse indicator - 8 mm 0.315 in spacing



ZS10-SF-R

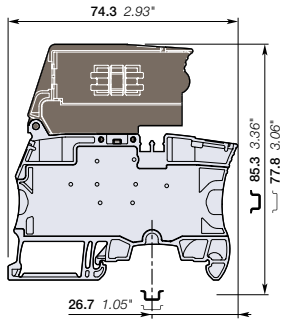

8 mm 0.315 in spacing



Description

- Protect your circuits with 6.3x32 (1/4 x 1 1/4 in) fuse terminal blocks compliant with IEC 60947-7-3 standard (fuse not supplied with the terminal blocks),
- Quickly identify the defective circuit thanks to the blown fuse indicator (with leakage current < 0.5 mA).

Ordering details

Description	Color	Type	Part Number	Pkg qty	Weight (1 pce) g
Fuse With blown fuse indicator 115 ... 250 V AC / DC	Grey, dark grey	ZS10-SF-R3	1SNK508422R0000	50	30.50
With blown fuse indicator 24 ... 110 V AC / DC		ZS10-SF-R1	1SNK508421R0000	50	30.50

Main technical data

Connecting capacity	IEC	UL - CSA	Mounting instructions
1 conductor per clamp	Rigid: Solid/Stranded Flexible without ferrule Flexible with non insulated ferrule Flexible with insulated ferrule Gauge	0.5 ... 10 mm ² 0.5 ... 10 mm ² 0.5 ... 10 mm ² 0.5 ... 6 mm ² A5-B5	Rail Wire stripping length Tool Torque
2 conductors per clamp	Rigid: Solid/Stranded Flexible without ferrule Flexible with twin ferrule	24 ... 6 AWG 24 ... 8 AWG 24 ... 10 AWG 20 ... 12 AWG 20 ... 12 AWG	TH 35-7.5, TH 35-15 13 mm 0.512 in Flat screwdriver Ø 4 mm Ø 0.157 in 1.3 Nm ± 0.3 11.5 lb.in ± 2.65
Rated current / Rated cross section	10 A / 10 mm ²	22 A / 6 AWG	
Rated voltage	630 V	600 V	
Impulse withstand voltage	6000 V		
Protection	IP20	NEMA 1	

Mount your fuse safely without touching any active part: put the fuse into the hooks of the fuse holder shutter; at the closing of the shutter, the fuse is perfectly in place in the fuse holder.

Separate arrangement		Assembly composed of 1 fuse terminal block in between non fuse terminal blocks	Overload and short-circuit protection	4 W
			Exclusive short-circuit protection	4 W
Compound arrangement		Assembly composed of 5 fuse terminal blocks	Overload and short-circuit protection	2.5 W
			Exclusive short-circuit protection	2.5 W

The connecting capacity data for one Rigid: Solid/Stranded, or one Flexible conductor (when applicable) is a mandatory information required by IEC, UL and CSA standards (Copper conductors). All other data are provided as supplementary information only. For more details, please consult our CB, UL or CSA certificates and technical datasheet available on <http://www.TE.com>

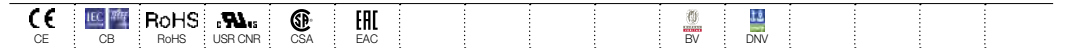

Accessories

Description	Color	Type	Part Number	Pkg qty	Weight (1 pce) g	
1 End stops	Dark grey	BAM4	1SNK900001R0000	50	14.00	
2 Jumper bars	Orange	2 poles	JB8-2	1SNK908302R0000	50	2.70
		3 poles	JB8-3	1SNK908303R0000	50	4.10
		4 poles	JB8-4	1SNK908304R0000	50	5.60
		5 poles	JB8-5	1SNK908305R0000	40	7.00
		10 poles	JB8-10	1SNK908310R0000	20	14.20
		3 Test adapters	Dark grey	For test plugs DIA 2 mm 0.079 in	TP2	1SNK900203R0000
For test plugs DIA 4 mm 0.157 in	TP4			1SNK900205R0000	20	2.40
4 Test connectors	Dark grey	5.2 mm 0.205 in spacing	TC5	1SNK900200R0000	10	5.20
		End module, 5.2 mm 0.205 in	TC5-R1	1SNK900201R0000	10	5.20
5 Spacers	Dark grey	ES-TC8	1SNK900104R0000	10	1.40	
6 Terminal block markers	White	Blank marker	MG-CPM 13 41791	1SNB041791R0612	1680	0.27
		Blank card	MC812	1SNK160000R0000	22	10.00
			MC812PA	1SNK169999R0000	20	14.00
		Universal wire markers holder	Grey	UMH	1SNK900611R0000	10

Complete list of accessories is indicated in the terminal block datasheet including end stops. Some accessories such as jumper bars may modify the terminal block's ratings: Complete information available in the accessories section of the catalog.

Technical data valid for copper conductors only.

ZS10-S-R2 screw clamp terminal blocks

Disconnect with lever - 8 mm 0.315 in spacing

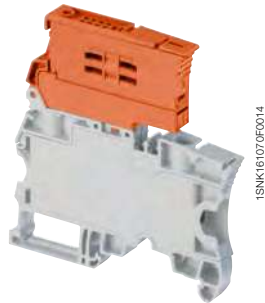

ZS10-S-R2

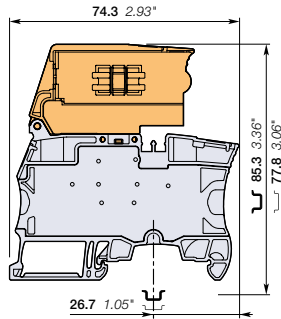

8 mm 0.315 in spacing

Description

Simplify the disconnect operations for the disconnect terminal blocks installed next to fuse terminal blocks ZS10-SF:
 – With the same profile as ZS10-SF, the ZS10-S-R2 disconnect lever is easily operated by hand and the wiring of the alternated disconnect and fuse circuits is easier.

Ordering details

Description	Color	Type	Part Number	Pkg qty	Weight (1 pce) g
Disconnect Profile aligned with ZS10-SF	Grey, orange	ZS10-S-R2	1SNK508417R0000	50	35.90

Main technical data

Connecting capacity	IEC	UL - CSA	Mounting instructions
1 conductor per clamp	Rigid: Solid/Stranded Flexible without ferrule Flexible with non insulated ferrule Flexible with insulated ferrule Gauge	0.5 ... 10 mm ² 0.5 ... 10 mm ² 0.5 ... 10 mm ² 0.5 ... 6 mm ² A5-B5	24 ... 6 AWG 24 ... 8 AWG 24 ... 10 AWG
2 conductors per clamp	Rigid: Solid/Stranded Flexible without ferrule Flexible with twin ferrule	0.5 ... 4 mm ² 0.5 ... 4 mm ² 0.5 ... 4 mm ²	20 ... 12 AWG 20 ... 12 AWG
Rated current / Rated cross section		10 A / 4 mm ² 25 A / 10 mm ²	
Maximum current / Maximum cross section		480 A	
Rated short-time withstand current (1s)		630 V 6000 V	
Rated voltage		600 V	
Impulse withstand voltage			
Protection		IP20	NEMA 1

Mounting instructions

Mounting instructions	Diagram	Dimensions
Rail		TH 35-7.5, TH 35-15
Wire stripping length		13 mm 0.512 in
Tool		Flat screwdriver Ø 4 mm Ø 0.157 in
Torque		1.3 Nm ± 0.3 11.5 lb.in ± 2.65

Recommendation for best usage: in horizontal assemblies, disconnect terminal blocks should be mounted with fixed foot on top (power side) so that the disconnect lever does not partially close through gravity. Furthermore, as specified per IEC 60947-7-1, disconnect terminal blocks are intended to be used for temporary disconnection at zero potential and at no load.

The connecting capacity data for one Rigid: Solid/Stranded, or one Flexible conductor (when applicable) is a mandatory information required by IEC, UL and CSA standards (Copper conductors). All other data are provided as supplementary information only. For more details, please consult our CB, UL or CSA certificates and technical datasheet available on <http://www.TE.com>

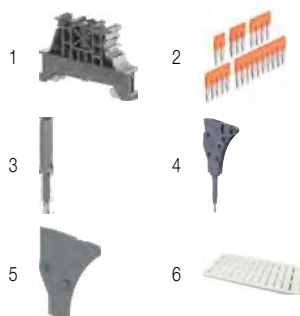
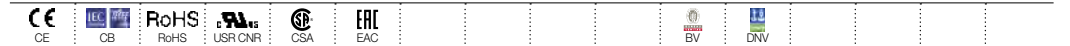

Accessories

Description	Color	Type	Part Number	Pkg qty	Weight (1 pce) g
1 End stops	Dark grey	BAM4	1SNK900001R0000	50	14.00
2 Jumper bars	Orange	JB8-2 JB8-3 JB8-4 JB8-5 JB8-10	1SNK908302R0000 1SNK908303R0000 1SNK908304R0000 1SNK908305R0000 1SNK908310R0000	50 50 50 40 20	14.00 4.10 5.60 7.00 14.20
3 Test adapters	Dark grey	TP2 TP4	1SNK900203R0000 1SNK900205R0000	20 20	1.70 2.40
4 Test connectors	Dark grey	TC5 TC5-R1	1SNK900200R0000 1SNK900201R0000	10 10	5.20 5.20
5 Spacers	Dark grey	ES-TC8	1SNK900104R0000	10	1.40
6 Terminal block markers	White	MG-CPM 13 41791 MC812 MC812PA	1SNB041791R0612 1SNK160000R0000 1SNK169999R0000	1680 22 20	0.27 10.00 14.00
	Grey	UMH	1SNK900611R0000	10	0.20

Complete list of accessories is indicated in the terminal block datasheet including end stops. Some accessories such as jumper bars may modify the terminal block's ratings: Complete information available in the accessories section of the catalog.

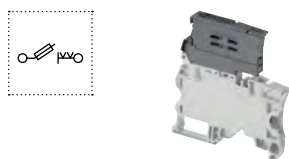

Fuse screw clamp terminal blocks

Description	Color	Type	Part Number	Pkg qty	Weight (1 pce) g
Fuse Closed block	Grey, dark grey	ZS10-SF	1SNK508418R0000	50	28.50

Technical data valid for copper conductors only.



ZS4-D2 screw clamp terminal blocks

Double deck with 2 feed-through circuits - 5.2 mm 0.205 in spacing



ZS4-D2

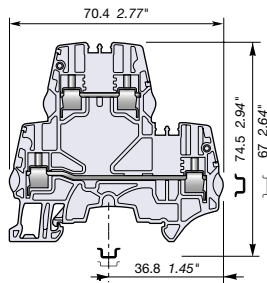

5.2 mm 0.205 in spacing

Description

- Save space with double deck terminal blocks: 2 independent circuits connected in just 5.2 mm 0.205 in spacing,
- Customize yourself the ZS4-D2 by soldering electronic components (up to 8.8 mm x 3.2 mm 0.346 x 0.125 in) in the existing linking bars punching.

Ordering details

Description	Color	Type	Part Number	Pkg qty	Weight (1 pce) g
Feed-through 2 feed-through circuits	Grey	ZS4-D2	1SNK505210R0000	50	15.30
	Blue	ZS4-D2-BL	1SNK505220R0000	50	15.30
	Orange	ZS4-D2-OR	1SNK505230R0000	50	15.30

Main technical data

Connecting capacity		IEC	UL - CSA	Mounting instructions	
1 conductor per clamp	Rigid: Solid/Stranded	0.2 ... 4 mm ²	24 ... 12 AWG	Rail	TH 35-7.5, TH 35-15
	Flexible without ferrule	0.22 ... 4 mm ²		Wire stripping length	10 mm 0.393 in
	Flexible with non insulated ferrule	0.22 ... 4 mm ²	24 ... 12 AWG		
	Flexible with insulated ferrule	0.22 ... 2.5 mm ²	24 ... 14 AWG	Tool	Flat screwdriver Ø 3.5 mm Ø 0.138 in
	Gauge	A3-B3			
2 conductors per clamp	Rigid: Solid/Stranded	0.2 ... 1.5 mm ²	24 ... 16 AWG	Torque	0.6 Nm ± 0.1 5.31 lb.in ± 0.885
	Flexible without ferrule	0.2 ... 1.5 mm ²			
	Flexible with twin ferrule	0.22 ... 1.5 mm ²	24 ... 16 AWG		
Rated current / Rated cross section		29 A / 4 mm ²	20 A / 12 AWG		
Rated short-time withstand current (1s)		480 A			
Short Circuit Current Rating (with specific conditions)			100 kA		
Rated voltage		800 V	300 V		
Impulse withstand voltage		8000 V			
Protection		IP20	NEMA 1		
Increased safety Ex e		440 V 29 A IEC/EN 60079-7 - IM2 II 2 GD Ex eb I/II/III C - 300 V 20 A UL 60079-7 - Class I, Zone 1, AEx e II, Ex e II U			

The connecting capacity data for one Rigid: Solid/Stranded, or one Flexible conductor (when applicable) is a mandatory information required by IEC, UL and CSA standards (Copper conductors). All other data are provided as supplementary information only. For more details, please consult our CB, UL or CSA certificates and technical datasheet available on <http://www.TE.com>



Accessories

Description	Color	Type	Part Number	Pkg qty	Weight (1 pce) g	
1 End stops 10 mm 0.394 in	Dark grey	BAZH1	1SNK900102R0000	20	24.00	
2 End sections 2.55 mm 0.100 in	Dark grey	ES4-D2	1SNK505960R0000	20	4.10	
3 Jumper bars 2 poles 32 A (IEC)	Orange	JB5-2	1SNK905302R0000	50	1.30	
		3 poles 32 A (IEC)	JB5-3	1SNK905303R0000	50	2.00
		4 poles 32 A (IEC)	JB5-4	1SNK905304R0000	50	2.70
		5 poles 32 A (IEC)	JB5-5	1SNK905305R0000	50	3.50
		10 poles 32 A (IEC)	JB5-10	1SNK905310R0000	30	7.10
4 Test adapters For test plugs DIA 2 mm 0.079 in	Dark grey	TP2	1SNK900203R0000	20	1.70	
		TP4	1SNK900205R0000	20	2.40	
5 Test connectors 5.2 mm 0.205 in spacing	Dark grey	TC5	1SNK900200R0000	10	5.20	
		End module, 5.2 mm 0.205 in	TC5-R1	1SNK900201R0000	10	5.20
6 Shield connectors		SHB	1SNK900602R0000	20	4.90	
7 Label holders	Dark grey	LH-J	1SNK900606R0000	100	0.73	
8 Terminal block markers	White	MG-CPM 13 41790	1SNB041790R0512	1960	0.23	
		MC512	1SNK140000R0000	22	9.00	
		MC512PA	1SNK149999R0000	20	10.00	
		Universal wire markers holder	Grey	UMH	1SNK900611R0000	10

Complete list of accessories is indicated in the terminal block datasheet including end stops. Some accessories such as jumper bars may modify the terminal block's ratings: Complete information available in the accessories section of the catalog.

Technical data valid for copper conductors only.

ZS4-D1 screw clamp terminal blocks

Double deck with 1 feed-through circuit - 5.2 mm 0.205 in spacing



4 mm²
12 AWG

Description

- Ease one potential distribution on 4 independent screw clamps,
- Save space by connecting conductors up to 4 mm² (CB certified) 12 AWG in just 5.2 mm 0.205 in spacing.

Ordering details

Description	Color	Type	Part Number	Pkg qty	Weight (1 pce) g
Feed-through 1 feed-through circuit	Grey <input type="checkbox"/>	ZS4-D1	1SNK505211R0000	50	15.30

Main technical data

Connecting capacity		IEC	UL - CSA	Mounting instructions	
1 conductor per clamp	Rigid: Solid/Stranded	0.2 ... 4 mm ²	24 ... 12 AWG	Rail	TH 35-7.5, TH 35-15
	Flexible without ferrule	0.22 ... 4 mm ²		Wire stripping length	10 mm 0.393 in
	Flexible with non insulated ferrule	0.22 ... 4 mm ²	24 ... 12 AWG	Tool	Flat screwdriver Ø 3.5 mm Ø 0.138 in
	Flexible with insulated ferrule	0.22 ... 2.5 mm ²	24 ... 14 AWG		
Gauge		A3-B3		Torque	0.6 Nm ± 0.1 5.31 lb.in ± 0.885
2 conductors per clamp	Rigid: Solid/Stranded	0.2 ... 1.5 mm ²	24 ... 16 AWG		
	Flexible without ferrule	0.2 ... 1.5 mm ²			
	Flexible with twin ferrule	0.22 ... 1.5 mm ²	24 ... 16 AWG		
Rated current / Rated cross section		29 A / 4 mm ²	20 A / 12 AWG		
Rated short-time withstand current (1s)		480 A			
Short Circuit Current Rating (with specific conditions)			100 kA		
Rated voltage		800 V	300 V		
Impulse withstand voltage		8000 V			
Protection		IP20	NEMA 1		

Increased safety Ex e 440 V 29 A IEC/EN 60079-7 - IM2 II 2 GD Ex eb III/IIIC - 300 V 20 A UL 60079-7 - Class I, Zone 1, AEx e II, Ex e II U

The connecting capacity data for one Rigid: Solid/Stranded, or one Flexible conductor (when applicable) is a mandatory information required by IEC, UL and CSA standards (Copper conductors). All other data are provided as supplementary information only. For more details, please consult our CB, UL or CSA certificates and technical datasheet available on <http://www.TE.com>

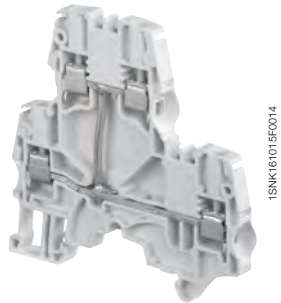

1SNK161015F0014

ZS4-D1

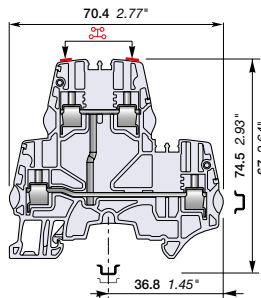

5.2 mm 0.205 in spacing

Accessories

Description	Color	Type	Part Number	Pkg qty	Weight (1 pce) g	
1 End stops	Dark grey <input checked="" type="checkbox"/>	BAZH1	1SNK900102R0000	20	24.00	
2 End sections	Dark grey <input checked="" type="checkbox"/>	ES4-D2	1SNK505960R0000	20	4.10	
3 Jumper bars	Orange <input checked="" type="checkbox"/>	2 poles	JB5-2	1SNK905302R0000	50	1.30
		3 poles	JB5-3	1SNK905303R0000	50	2.00
		4 poles	JB5-4	1SNK905304R0000	50	2.70
		5 poles	JB5-5	1SNK905305R0000	50	3.50
		10 poles	JB5-10	1SNK905310R0000	30	7.10
4 Test adapters	Dark grey <input checked="" type="checkbox"/>	For test plugs DIA 2 mm 0.079 in	TP2	1SNK900203R0000	20	1.70
		For test plugs DIA 4 mm 0.157 in	TP4	1SNK900205R0000	20	2.40
5 Test connectors	Dark grey <input checked="" type="checkbox"/>	5.2 mm 0.205 in spacing	TC5	1SNK900200R0000	10	5.20
		End module, 5.2 mm 0.205 in	TC5-R1	1SNK900201R0000	10	5.20
6 Shield connectors		SHB	1SNK900602R0000	20	4.90	
7 Label holders	Dark grey <input checked="" type="checkbox"/>	LH-J	1SNK900606R0000	100	0.73	
8 Terminal block markers	White <input type="checkbox"/>	Blank marker	MG-CPM 13 41790	1SNB041790R0512	1960	0.23
		Blank card	MC512	1SNK140000R0000	22	9.00
			MC512PA	1SNK149999R0000	20	10.00
		Universal wire markers holder	Grey <input type="checkbox"/>	UMH	1SNK900611R0000	10

Complete list of accessories is indicated in the terminal block datasheet including end stops.

Some accessories such as jumper bars may modify the terminal block's ratings: Complete information available in the accessories section of the catalog.

Technical data valid for copper conductors only.

ZS6-D2 screw clamp terminal blocks

Double deck with 2 feed-through circuits - 6 mm 0.236 in spacing

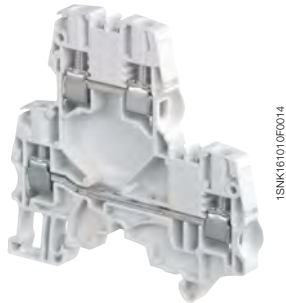

ZS6-D2

Description

- Save space with double deck terminal blocks: 2 independent circuits connected in just 6 mm 0.236 in spacing,
- Customize yourself the ZS6-D2 by soldering electronic components (up to 8.8 mm x 3.2 mm 0.346 x 0.125 in) in the existing linking bars punching,
- Boost the performances: ZS6-D... with ES4-D2 end section is rated 1000 V DC IEC, perfectly adapted to solar applications.

Ordering details

Description	Color	Type	Part Number	Pkg qty	Weight (1 pce) g
Feed-through 2 feed-through circuits	Grey	ZS6-D2	1SNK506210R0000	50	18.40
	Blue	ZS6-D2-BL	1SNK506220R0000	50	18.40
	Orange	ZS6-D2-OR	1SNK506230R0000	50	18.40
	Yellow	ZS6-D2-YL	1SNK506260R0000	50	18.40
	Red	ZS6-D2-RD	1SNK506262R0000	50	18.40
	White	ZS6-D2-WH	1SNK506265R0000	50	18.40
	Black	ZS6-D2-BK	1SNK506266R0000	50	18.40

Main technical data

Connecting capacity	IEC	UL - CSA	Mounting instructions
1 conductor per clamp	Rigid: Solid/Stranded	0.2 ... 6 mm ²	24 ... 10 AWG
	Flexible without ferrule	0.2 ... 6 mm ²	24 ... 10 AWG
	Flexible with non insulated ferrule	0.22 ... 4 mm ²	24 ... 12 AWG
	Flexible with insulated ferrule	0.22 ... 4 mm ²	24 ... 12 AWG
	Gauge	A4-B3	
2 conductors per clamp	Rigid: Solid/Stranded	0.2 ... 2.5 mm ²	24 ... 14 AWG
	Flexible without ferrule	0.2 ... 2.5 mm ²	24 ... 14 AWG
	Flexible with twin ferrule	0.22 ... 2.5 mm ²	24 ... 14 AWG
Rated current / Rated cross section	40 A / 6 mm ²	30 A / 10 AWG	
Rated short-time withstand current (1s)	720 A		
Short Circuit Current Rating (with specific conditions)		100 kA	
Rated voltage	800 V	300 V	
Impulse withstand voltage	8000 V		
Protection	IP20	NEMA 1	

Increased safety Ex e 440 V 40 A IEC/EN 60079-7 - IM2 II 2 GD Ex eb I/II/IIIc - 300 V 30 A UL 60079-7 - Class I, Zone 1, AEx e II, Ex e II U

The connecting capacity data for one Rigid: Solid/Stranded, or one Flexible conductor (when applicable) is a mandatory information required by IEC, UL and CSA standards (Copper conductors). All other data are provided as supplementary information only. For more details, please consult our CB, UL or CSA certificates and technical datasheet available on <http://www.TE.com>

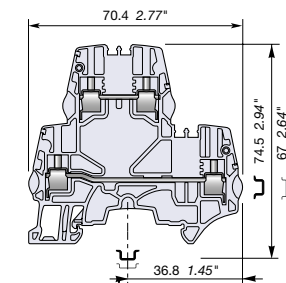

6 mm 0.236 in spacing

Accessories

Description	Color	Type	Part Number	Pkg qty	Weight (1 pce) g	
1 End stops	Dark grey	BAZH1	1SNK900102R0000	20	24.00	
2 End sections	Dark grey	ES4-D2	1SNK505960R0000	20	4.10	
3 Jumper bars	Orange	2 poles	JB6-2	1SNK906302R0000	50	1.30
		3 poles	JB6-3	1SNK906303R0000	50	2.10
		4 poles	JB6-4	1SNK906304R0000	50	2.90
		5 poles	JB6-5	1SNK906305R0000	50	3.60
		10 poles	JB6-10	1SNK906310R0000	20	7.40
4 Test adapters	Dark grey	For test plugs DIA 2 mm 0.079 in	TP2	1SNK900203R0000	20	1.70
		For test plugs DIA 4 mm 0.157 in	TP4	1SNK900205R0000	20	2.40
5 Test connectors	Dark grey	TC5-R1	1SNK900201R0000	10	5.20	
6 Spacers	Dark grey	ES-TC6	1SNK900105R0000	10	0.80	
7 Shield connectors		SHB	1SNK900602R0000	20	4.90	
8 Terminal block markers	White	Blank marker	MG-CPM 13 41791	1SNB041791R0612	1680	0.27
		Blank card	MC612	1SNK150000R0000	22	10.00
			MC612PA	1SNK159999R0000	20	11.00
	Universal wire markers holder	Grey	UMH	1SNK900611R0000	10	0.20

Complete list of accessories is indicated in the terminal block datasheet including end stops. Some accessories such as jumper bars may modify the terminal block's ratings: Complete information available in the accessories section of the catalog.

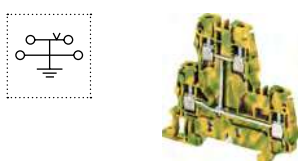
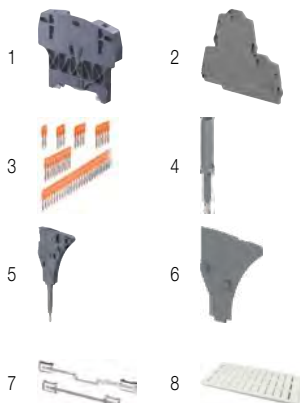

Ground screw clamp terminal blocks

Description	Color	Type	Part Number	Pkg qty	Weight (1 pce) g
Ground Profile aligned with ZS6-D2 and ZS6-D1	Green-yellow	ZS6-D1-PE	1SNK506250R0000	20	18.40

Technical data valid for copper conductors only.

ZS6-D1 screw clamp terminal blocks

Double deck with 1 feed-through circuit - 6 mm 0.236 in spacing

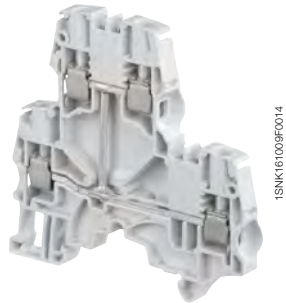

ZS6-D1

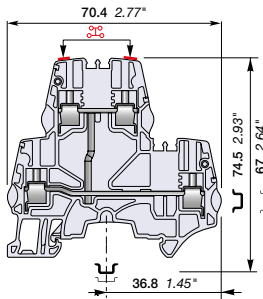

6 mm 0.236 in spacing

Description

- Ease one potential distribution on 4 independent screw clamps,
- Save space by connecting conductors up to 6 mm² 10 AWG in just 6 mm 0.236 in spacing,
- Boost the performances: ZS6-D... with ES4-D2 end section is rated 1000 V DC IEC, perfectly adapted to solar applications.

Ordering details

Description	Color	Type	Part Number	Pkg qty	Weight (1 pce) g
Feed-through 1 feed-through circuit	Grey <input type="checkbox"/>	ZS6-D1	1SNK506211R0000	50	18.40
	Red <input checked="" type="checkbox"/>	ZS6-D1-RD	1SNK506214R0000	50	18.40

Main technical data

Connecting capacity		IEC	UL - CSA	Mounting instructions	
1 conductor per clamp	Rigid: Solid/Stranded	0.2 ... 6 mm ²	24 ... 10 AWG	Rail	TH 35-7.5, TH 35-15
	Flexible without ferrule	0.2 ... 6 mm ²		Wire stripping length	10 mm 0.393 in
	Flexible with non insulated ferrule	0.22 ... 4 mm ²	24 ... 12 AWG	Tool	Flat screwdriver Ø 4 mm Ø 0.157 in
	Flexible with insulated ferrule	0.22 ... 4 mm ²	24 ... 12 AWG		
Gauge		A4-B3		Torque	0.85 Nm ± 0.15 7.52 lb.in ± 1.33
2 conductors per clamp	Rigid: Solid/Stranded	0.2 ... 2.5 mm ²	24 ... 14 AWG		
	Flexible without ferrule	0.2 ... 2.5 mm ²			
	Flexible with twin ferrule	0.22 ... 2.5 mm ²	24 ... 14 AWG		
Rated current / Rated cross section		40 A / 6 mm ²	30 A / 10 AWG		
Rated short-time withstand current (1s)		720 A			
Short Circuit Current Rating (with specific conditions)			100 kA		
Rated voltage		800 V	300 V		
Impulse withstand voltage		8000 V			
Protection		IP20	NEMA 1		

Increased safety Ex e 440 V 40 A IEC/EN 60079-7 - IM2 II 2 GD Ex eb I/IIIC - 300 V 30 A UL 60079-7 - Class I, Zone 1, AEx e II, Ex e II U

The connecting capacity data for one Rigid: Solid/Stranded, or one Flexible conductor (when applicable) is a mandatory information required by IEC, UL and CSA standards (Copper conductors). All other data are provided as supplementary information only. For more details, please consult our CB, UL or CSA certificates and technical datasheet available on <http://www.TE.com>

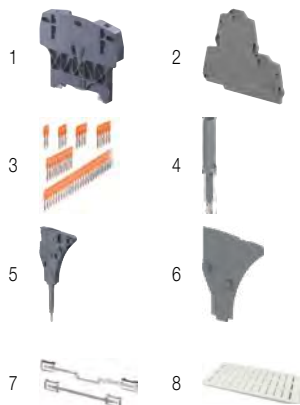

Accessories

Description	Color	Type	Part Number	Pkg qty	Weight (1 pce) g	
1 End stops	Dark grey <input checked="" type="checkbox"/>	BAZH1	1SNK900102R0000	20	24.00	
2 End sections	Dark grey <input checked="" type="checkbox"/>	ES4-D2	1SNK505960R0000	20	4.10	
3 Jumper bars	Orange <input checked="" type="checkbox"/>	2 poles	JB6-2	1SNK906302R0000	50	1.30
		3 poles	JB6-3	1SNK906303R0000	50	2.10
		4 poles	JB6-4	1SNK906304R0000	50	2.90
		5 poles	JB6-5	1SNK906305R0000	50	3.60
		10 poles	JB6-10	1SNK906310R0000	20	7.40
4 Test adapters	Dark grey <input checked="" type="checkbox"/>	For test plugs DIA 2 mm 0.079 in	TP2	1SNK900203R0000	20	1.70
		For test plugs DIA 4 mm 0.157 in	TP4	1SNK900205R0000	20	2.40
5 Test connectors	Dark grey <input checked="" type="checkbox"/>	TC5-R1	1SNK900201R0000	10	5.20	
6 Spacers	Dark grey <input checked="" type="checkbox"/>	ES-TC6	1SNK900105R0000	10	0.80	
7 Shield connectors		SHB	1SNK900602R0000	20	4.90	
8 Terminal block markers	White <input type="checkbox"/>	Blank marker	MG-CPM 13 41791	1SNB041791R0612	1680	0.27
		Blank card	MC612	1SNK150000R0000	22	10.00
		Universal wire markers holder	Grey <input type="checkbox"/>	UMH	1SNK900611R0000	10

Complete list of accessories is indicated in the terminal block datasheet including end stops. Some accessories such as jumper bars may modify the terminal block's ratings: Complete information available in the accessories section of the catalog.

Technical data valid for copper conductors only.

ZS6-D2-PE screw clamp terminal blocks

Double deck with 1 feed-through circuit and 1 ground circuit - 6 mm 0.236 in spacing



ZS6-D2-PE

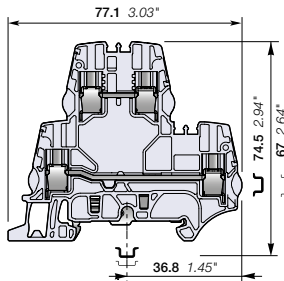

6 mm 0.236 in spacing

Description

- Save space with ZS6-D2-PE terminal blocks: 1 feed-through circuit and 1 ground circuit in just 6 mm 0.236 in spacing,
- Customize yourself the ZS6-D2-PE terminal blocks by soldering electronic components (up to 8.8 mm x 3.2 mm 0.346 x 0.125 in) in the existing linking bars punching.

Ordering details

Description	Color	Type	Part Number	Pkg qty	Weight (1 pce) g
Feed-through + ground	Grey	<input type="checkbox"/> ZS6-D2-PE	1SNK506212R0000	50	18.40

Main technical data

Connecting capacity		IEC	UL - CSA	Mounting instructions	
1 conductor per clamp	Rigid: Solid/Stranded	0.2 ... 6 mm ²	24 ... 10 AWG	Rail	TH 35-7.5, TH 35-15
	Flexible without ferrule	0.22 ... 6 mm ²		Wire stripping length	10 mm 0.393 in
	Flexible with non insulated ferrule	0.22 ... 4 mm ²	24 ... 12 AWG		
	Flexible with insulated ferrule	0.22 ... 4 mm ²	24 ... 12 AWG		
	Gauge	A4-B3		Tool	Flat screwdriver Ø 4 mm Ø 0.157 in
2 conductors per clamp	Rigid: Solid/Stranded	0.2 ... 2.5 mm ²	24 ... 14 AWG		
	Flexible without ferrule	0.2 ... 2.5 mm ²	24 ... 14 AWG		
	Flexible with twin ferrule	0.22 ... 2.5 mm ²	24 ... 14 AWG	Torque	0.85 Nm ± 0.15 7.52 lb.in ± 1.33
	Rated current / Rated cross section	41 A / 6 mm ²	30 A / 10 AWG		
	Rated short-time withstand current (1s)	720 A			
	Short Circuit Current Rating (with specific conditions)				
	Rated voltage	800 V	300 V		
	Impulse withstand voltage	8000 V			
	Protection	IP20	NEMA 1		

The connecting capacity data for one Rigid: Solid/Stranded, or one Flexible conductor (when applicable) is a mandatory information required by IEC, UL and CSA standards (Copper conductors). All other data are provided as supplementary information only. For more details, please consult our CB, UL or CSA certificates and technical datasheet available on <http://www.TE.com>

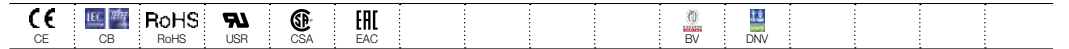

Accessories

Description	Color	Type	Part Number	Pkg qty	Weight (1 pce) g	
1 End stops	Dark grey	BZH1	1SNK900102R0000	20	24.00	
2 End sections	Dark grey	ES4-D2	1SNK505960R0000	20	4.10	
3 Jumper bars	Orange	2 poles	41 A (IEC) JB6-2	1SNK906302R0000	50	1.30
		3 poles	41 A (IEC) JB6-3	1SNK906303R0000	50	2.10
		4 poles	41 A (IEC) JB6-4	1SNK906304R0000	50	2.90
		5 poles	41 A (IEC) JB6-5	1SNK906305R0000	50	3.60
		10 poles	41 A (IEC) JB6-10	1SNK906310R0000	20	7.40
4 Test adapters	Dark grey	TP4	1SNK900205R0000	20	2.40	
5 Test connectors	Dark grey	TC5-R1	1SNK900201R0000	10	5.20	
6 Spacers	Dark grey	ES-TC6	1SNK900105R0000	10	0.80	
7 Terminal block markers	White	Blank marker	MG-CPM 13 41791	1SNB041791R0612	1680	0.27
		Blank card	MC612	1SNK150000R0000	22	10.00
			MC612PA	1SNK159999R0000	20	11.00
	Universal wire markers holder	Grey	UMH	1SNK900611R0000	10	0.20

Complete list of accessories is indicated in the terminal block datasheet including end stops.

Some accessories such as jumper bars may modify the terminal block's ratings: Complete information available in the accessories section of the catalog.

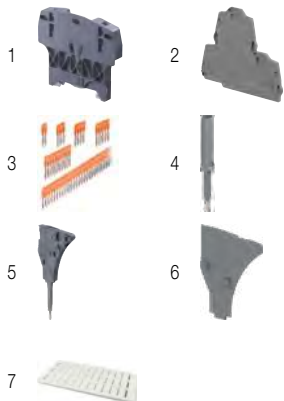

Feed-through screw clamp terminal blocks

Description	Color	Type	Part Number	Pkg qty	Weight (1 pce) g
Feed-through	Grey	<input type="checkbox"/> ZS6-D2	1SNK506210R0000	50	18.40



Technical data valid for copper conductors only.

ZS6-D1-PE screw clamp terminal blocks

Double deck with 1 ground circuit - 6 mm 0.236 in spacing



ZS6-D1-PE

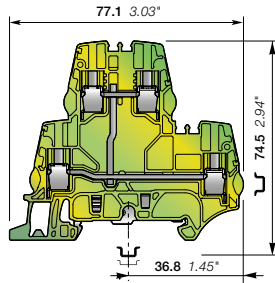

6 mm 0.236 in spacing

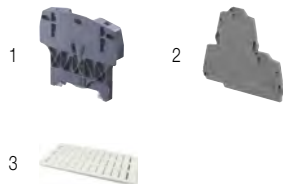

Description

- Save space with double deck ground terminal blocks aligned with ZS6-D2 double deck terminal blocks for convenient cabling process and circuit configuration,
- Benefit from our screwless rail connection: non operator independant, secured snap on or remove from the rail, performances above the requirements of IEC 60947-7-2 standard.

Ordering details

Description	Color	Type	Part Number	Pkg qty	Weight (1 pce) g
Ground 1 ground circuit	Green-yellow	ZS6-D1-PE	1SNK506250R0000	20	18.40

Main technical data

Connecting capacity		IEC	UL - CSA	Mounting instructions	
1 conductor per clamp	Rigid: Solid/Stranded	0.2 ... 6 mm ²	24 ... 10 AWG	Rail	TH 35-7.5, TH 35-15
	Flexible without ferrule	0.22 ... 6 mm ²		Wire stripping length	10 mm 0.393 in
	Flexible with non insulated ferrule	0.22 ... 4 mm ²	24 ... 12 AWG		
	Flexible with insulated ferrule	0.22 ... 4 mm ²	24 ... 12 AWG		
	Gauge	A4-B3		Tool	Flat screwdriver Ø 4 mm Ø 0.157 in
Rated cross section		6 mm ²	10 AWG	Torque	0.85 Nm ± 0.15 7.52 lb.in ± 1.33
Rated short-time withstand current (1s)		720 A			
Protection		IP20	NEMA 1		

The connecting capacity data for one Rigid: Solid/Stranded, or one Flexible conductor (when applicable) is a mandatory information required by IEC, UL and CSA standards (Copper conductors). All other data are provided as supplementary information only. For more details, please consult our CB, UL or CSA certificates and technical datasheet available on <http://www.TE.com>

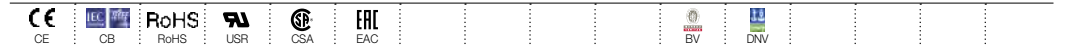

Accessories

Description	Color	Type	Part Number	Pkg qty	Weight (1 pce) g
1 End stops	Dark grey	BAZH1	1SNK900102R0000	20	24.00
2 End sections	Dark grey	ES4-D2	1SNK505960R0000	20	4.10
3 Terminal block markers	White	MG-CPM 13 41791	1SNB041791R0612	1680	0.27
		MC612	1SNK150000R0000	22	10.00
		MC612PA	1SNK159999R0000	20	11.00
Universal wire markers holder	Grey	UMH	1SNK900611R0000	10	0.20

Complete list of accessories is indicated in the terminal block datasheet including end stops.

Some accessories such as jumper bars may modify the terminal block's ratings: Complete information available in the accessories section of the catalog.

Technical data valid for copper conductors only.

ZS4-D2-S screw clamp terminal blocks

Double deck with 1 disconnect circuit and 1 feed-through circuit - 5.2 mm 0.205 in spacing



ZS4-D2-S

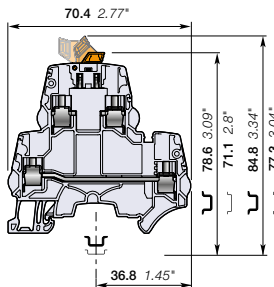

5.2 mm 0.205 in spacing

Description

- Save space: connect one complete circuit on a single block featuring disconnect and feed-through for the return circuit in just 5.2 mm 0.205 in spacing,
- Same profile as ZS4-D... double deck terminal blocks: convenient cabling process, aligned jumpers, markers and common end section.

Ordering details

Description	Color	Type	Part Number	Pkg qty	Weight (1 pce) g
Feed-through + 1 disconnect circuit and 1 feed-through circuit	Grey <input type="checkbox"/>	ZS4-D2-S	1SNK505315R0000	50	15.90

Main technical data

Connecting capacity		IEC	UL - CSA	Mounting instructions	
1 conductor per clamp	Rigid: Solid/Stranded	0.2 ... 4 mm ²	24 ... 10 AWG	Rail	TH 35-7.5, TH 35-15
	Flexible without ferrule	0.22 ... 4 mm ²		Wire stripping length	10.5 mm 0.413 in
	Flexible with non insulated ferrule	0.22 ... 4 mm ²	24 ... 12 AWG		
	Flexible with insulated ferrule	0.22 ... 2.5 mm ²	24 ... 14 AWG		
	Gauge	A3-B3			
2 conductors per clamp	Rigid: Solid/Stranded	0.2 ... 1.5 mm ²	24 ... 16 AWG	Tool	Flat screwdriver Ø 3.5 mm Ø 0.138 in
	Flexible without ferrule	0.2 ... 1.5 mm ²			
	Flexible with twin ferrule	0.22 ... 1.5 mm ²	24 ... 16 AWG		
Disconnect circuit				Torque	0.6 Nm ± 0.1 5.31 lb.in ± 0.885
Rated current / Rated cross section		25 A / 4 mm ²	27 A / 10 AWG		
Feed-through circuit					
Rated current / Rated cross section		29 A / 4 mm ²	27 A / 10 AWG		
Rated short-time withstand current (1s)		480 A			
Rated voltage		630 V	300 V		
Impulse withstand voltage		8000 V			
Protection		IP20	NEMA 1		

Recommendation for best usage: in horizontal assemblies, disconnect terminal blocks should be mounted with fixed foot on top (power side) so that the disconnect knife does not partially close through gravity. Furthermore, as specified per IEC 60947-7-1, disconnect terminal blocks are intended to be used for temporary disconnection at zero potential and at no load.

The connecting capacity data for one Rigid: Solid/Stranded, or one Flexible conductor (when applicable) is a mandatory information required by IEC, UL and CSA standards (Copper conductors). All other data are provided as supplementary information only. For more details, please consult our CB, UL or CSA certificates and technical datasheet available on <http://www.TE.com>

--	--	--	--	--	--	--	--

Accessories

Description	Color	Type	Part Number	Pkg qty	Weight (1 pce) g	
1 End stops	Dark grey <input type="checkbox"/>	BAZH1	1SNK900102R0000	20	24.00	
2 End sections	Dark grey <input type="checkbox"/>	ES4-D2	1SNK505960R0000	20	4.10	
3 Jumper bars	Orange <input type="checkbox"/>	2 poles	JB5-2	1SNK905302R0000	50	1.30
		3 poles	JB5-3	1SNK905303R0000	50	2.00
		4 poles	JB5-4	1SNK905304R0000	50	2.70
		5 poles	JB5-5	1SNK905305R0000	50	3.50
		10 poles	JB5-10	1SNK905310R0000	30	7.10
		50 poles	JB5-50	1SNK905350R0000	10	36.00
4 Test adapters	Dark grey <input type="checkbox"/>	For test plugs DIA 2 mm 0.079 in	TP2	1SNK900203R0000	20	1.70
		For test plugs DIA 4 mm 0.157 in	TP4	1SNK900205R0000	20	2.40
5 Shield connectors		SHB	1SNK900602R0000	20	4.90	
6 Terminal block markers	White <input type="checkbox"/>	Blank marker	MG-CPM 13 41790	1SNB041790R0512	1960	0.23
		Blank card	MC512	1SNK140000R0000	22	9.00
			MC512PA	1SNK149999R0000	20	10.00
		Universal wire markers holder	Grey <input type="checkbox"/>	UMH	1SNK900611R0000	10

Complete list of accessories is indicated in the terminal block datasheet including end stops. Some accessories such as jumper bars may modify the terminal block's ratings: Complete information available in the accessories section of the catalog.

Technical data valid for copper conductors only.

ZS4-D2-S-T screw clamp terminal blocks

Double deck with 1 disconnect circuit with test socket screws and 1 feed-through circuit - 5.2 mm 0.205 in spacing

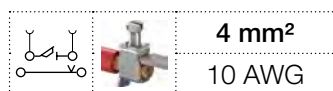

ZS4-D2-S-T

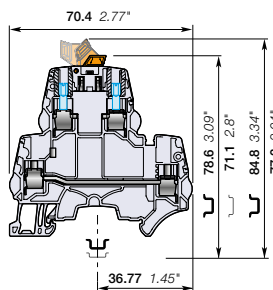

5.2 mm 0.205 in spacing

Description

Find the same functionalities as ZS4-D2-S, upgraded with the two built-in test socket screws meant to ease your signal testing during commissioning and maintenance.

Ordering details

Description	Color	Type	Part Number	Pkg qty	Weight (1 pce)
Feed-through + disconnect	Grey <input type="checkbox"/>	ZS4-D2-S-T2	1SNK505316R0000	50	16.20 g

Main technical data

Connecting capacity		IEC	UL - CSA	Mounting instructions	
1 conductor per clamp	Rigid: Solid/Stranded	0.2 ... 4 mm ²	24 ... 10 AWG	Rail	TH 35-7.5, TH 35-15
	Flexible without ferrule	0.22 ... 4 mm ²	24 ... 12 AWG	Wire stripping length	10.5 mm 0.413 in
	Flexible with non insulated ferrule	0.22 ... 4 mm ²	24 ... 12 AWG	Tool	Flat screwdriver Ø 3.5 mm Ø 0.138 in
	Flexible with insulated ferrule	0.22 ... 2.5 mm ²	24 ... 14 AWG		
Gauge		A3-B3		Torque	0.6 Nm ± 0.1 5.31 lb.in ± 0.885
2 conductors per clamp	Rigid: Solid/Stranded	0.2 ... 1.5 mm ²	24 ... 16 AWG		
		Flexible without ferrule	0.2 ... 1.5 mm ²		
		Flexible with twin ferrule	0.22 ... 1.5 mm ²		
Disconnect circuit					
Rated current / Rated cross section		25 A / 4 mm ²	27 A / 10 AWG		
Feed-through circuit					
Rated current / Rated cross section		29 A / 4 mm ²	27 A / 10 AWG		
Rated short-time withstand current (1s)		480 A			
Rated voltage		630 V	300 V		
Impulse withstand voltage		8000 V			
Protection		IP20	NEMA 1		

Recommendation for best usage: in horizontal assemblies, disconnect terminal blocks should be mounted with fixed foot on top (power side) so that the disconnect knife does not partially close through gravity. Furthermore, as specified per IEC 60947-7-1, disconnect terminal blocks are intended to be used for temporary disconnection at zero potential and at no load.

The connecting capacity data for one Rigid: Solid/Stranded, or one Flexible conductor (when applicable) is a mandatory information required by IEC, UL and CSA standards (Copper conductors). All other data are provided as supplementary information only. For more details, please consult our CB, UL or CSA certificates and technical datasheet available on <http://www.TE.com>



Accessories

Description	Color	Type	Part Number	Pkg qty	Weight (1 pce)	
1 End stops	Dark grey <input checked="" type="checkbox"/>	BAZH1	1SNK900102R0000	20	24.00 g	
2 End sections	Dark grey <input checked="" type="checkbox"/>	ES4-D2	1SNK505960R0000	20	4.10 g	
3 Jumper bars	Orange <input checked="" type="checkbox"/>	2 poles	JB5-2	1SNK905302R0000	50	1.30 g
		3 poles	JB5-3	1SNK905303R0000	50	2.00 g
		4 poles	JB5-4	1SNK905304R0000	50	2.70 g
		5 poles	JB5-5	1SNK905305R0000	50	3.50 g
		10 poles	JB5-10	1SNK905310R0000	30	7.10 g
		50 poles	JB5-50	1SNK905350R0000	10	36.00 g
4 Test adapters	Dark grey <input checked="" type="checkbox"/>	For test plugs DIA 2 mm 0.079 in	TP2	1SNK900203R0000	20	1.70 g
		For test plugs DIA 4 mm 0.157 in	TP4	1SNK900205R0000	20	2.40 g
5 Shield connectors		SHB	1SNK900602R0000	20	4.90 g	
6 Terminal block markers	White <input type="checkbox"/>	Blank marker	MG-CPM 13 41790	1SNB041790R0512	1960	0.23 g
		Blank card	MC512	1SNK140000R0000	22	9.00 g
			MC512PA	1SNK149999R0000	20	10.00 g
		Universal wire markers holder	Grey <input type="checkbox"/>	UMH	1SNK900611R0000	10

Complete list of accessories is indicated in the terminal block datasheet including end stops.

Some accessories such as jumper bars may modify the terminal block's ratings: Complete information available in the accessories section of the catalog.

Technical data valid for copper conductors only.

ZS4-D2-SF1 screw clamp terminal blocks

Double deck with 1 fuse circuit and 1 feed-through circuit - 8 mm 0.315 in spacing



ZS4-D2-SF1

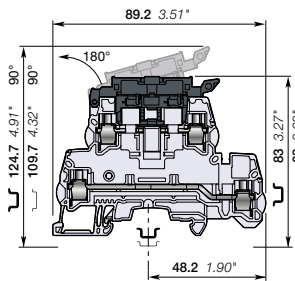

8 mm 0.315 in spacing

Description

- Save space: connect one complete circuit on a single block featuring fuse and feed-through for the return circuit,
- Protect your circuit with either 5X20 or 5X25 fuse (fuse not supplied with the terminal blocks),
- High performances product: compliant with IEC 60947-7-3 standard and jumper channel for the feed-through circuit.

Ordering details

Description	Color	Type	Part Number	Pkg qty	Weight (1 pce)
Feed-through + fuse 1 fuse circuit and 1 feed-through circuit	Grey, dark grey	ZS4-D2-SF1	1SNK508425R0000	50	27.50 g

Main technical data

Connecting capacity		IEC	UL - CSA	Mounting instructions	
1 conductor per clamp	Rigid: Solid/Stranded	0.2 ... 6 mm ²	24 ... 10 AWG	Rail	 TH 35-7.5, TH 35-15
	Flexible without ferrule	0.22 ... 4 mm ²	24 ... 10 AWG		
	Flexible with non insulated ferrule	0.22 ... 4 mm ²	24 ... 12 AWG	Wire stripping length	 11 mm 0.433 in
	Flexible with insulated ferrule	0.22 ... 4 mm ²	24 ... 12 AWG		
Gauge		A3-B3		Tool	 Flat screwdriver Ø 3.5 mm Ø 0.138 in
2 conductors per clamp	Rigid: Solid/Stranded	0.2 ... 2.5 mm ²	24 ... 14 AWG		
	Flexible without ferrule	0.2 ... 2.5 mm ²	24 ... 14 AWG		
	Flexible with twin ferrule	0.22 ... 2.5 mm ²	24 ... 14 AWG		
Disconnect circuit				Torque	 0.6 Nm ± 0.1 5.31 lb.in ± 0.885
Rated current / Rated cross section		6.3 A / 4 mm ²	12 A / 10 AWG		
Feed-through circuit					
Rated current / Rated cross section		32 A / 4 mm ²	30 A / 10 AWG		
Rated voltage		800 V	300 V		
Impulse withstand voltage		8000 V			
Protection		IP20	NEMA 1		

Separate arrangement		Assembly composed of 1 fuse terminal block in between non fuse terminal blocks	Overload and short-circuit protection	2.5 W
			Exclusive short-circuit protection	4 W
Compound arrangement		Assembly composed of 5 fuse terminal blocks	Overload and short-circuit protection	1.6 W
			Exclusive short-circuit protection	4 W

The connecting capacity data for one Rigid: Solid/Stranded, or one Flexible conductor (when applicable) is a mandatory information required by IEC, UL and CSA standards (Copper conductors). All other data are provided as supplementary information only. For more details, please consult our CB, UL or CSA certificates and technical datasheet available on <http://www.TE.com>

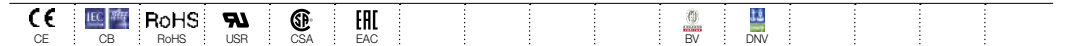

Accessories

Description	Color	Type	Part Number	Pkg qty	Weight (1 pce)	
1 End stops 10 mm 0.394 in	Dark grey	BAZH1	1SNK900102R0000	20	24.00	
2 End sections 2.5 mm 0.098 in	Dark grey	ES4-D2-SF1	1SNK508911R0000	20	5.00	
3 Jumper bars	Orange	2 poles 57 A (IEC)	JB8-2	1SNK908302R0000	50	2.70
		3 poles 57 A (IEC)	JB8-3	1SNK908303R0000	50	4.10
		4 poles 57 A (IEC)	JB8-4	1SNK908304R0000	50	5.60
		5 poles 57 A (IEC)	JB8-5	1SNK908305R0000	40	7.00
		10 poles 57 A (IEC)	JB8-10	1SNK908310R0000	20	14.20
4 Lateral jumper bars 10 poles 35 A (IEC)	Grey	PC81-10	1SNA173523R1100	10	5.00	
5 Test adapters	Dark grey	For test plugs DIA 2 mm 0.079 in	TP2	1SNK900203R0000	20	1.70
		For test plugs DIA 4 mm 0.157 in	TP4	1SNK900205R0000	20	2.40
6 Test connectors	Dark grey	5.2 mm 0.205 in spacing	TC5	1SNK900200R0000	10	5.20
		End module, 5.2 mm 0.205 in	TC5-R1	1SNK900201R0000	10	5.20
7 Spacers 2.8 mm 0.110 in	Dark grey	ES-TC8	1SNK900104R0000	10	1.40	
8 Assembly rods		2 poles	TGA8	1SNA168672R1100	10	1.00
		3 poles	TGA8	1SNA168673R1200	10	1.50
		4 poles	TGA8	1SNA168674R1300	10	2.00
9 Terminal block markers	White	Blank marker	MG-CPM 13 41791	1SNB041791R0612	1680	0.27
		Blank card	MC812	1SNK160000R0000	22	10.00
			MC812PA	1SNK169999R0000	20	14.00
Universal wire markers holder	Grey	UMH	1SNK900611R0000	10	0.20	

Complete list of accessories is indicated in the terminal block datasheet including end stops. Some accessories such as jumper bars may modify the terminal block's ratings: Complete information available in the accessories section of the catalog.

Technical data valid for copper conductors only.

ZS4-D2-SF1-R screw clamp terminal blocks

Double deck with 1 fuse circuit with blown fuse indicator and 1 feed-through circuit - 8 mm 0.315 in spacing

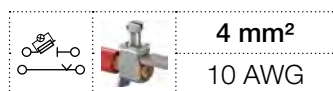

4 mm²
10 AWG

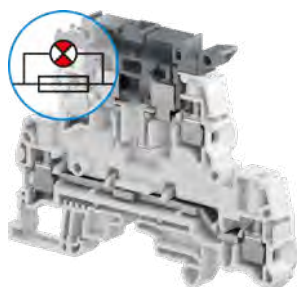

1SNK1610970014

ZS4-D2-SF1-R

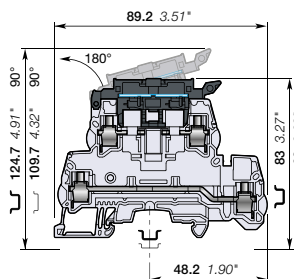

8 mm 0.315 in spacing

Description

- Find the same functionalities as ZS4-D2-SF1, upgraded with our integrated blown fuse indicator (with leakage current < 0.5 mA),
- Only one part number needed to fit AC / DC 24 V up to 110 V.

Ordering details

Description	Color	Type	Part Number	Pkg qty	Weight (1 pce) g
Feed-through + fuse	Grey, dark grey	ZS4-D2-SF1-R3	1SNK508424R0000	50	29.40
		ZS4-D2-SF1-R1	1SNK508423R0000	50	29.40

Main technical data

Connecting capacity	IEC	UL - CSA	Mounting instructions
1 conductor per clamp Rigid: Solid/Stranded 0.2 ... 6 mm ² Flexible without ferrule 0.22 ... 4 mm ² Flexible with non insulated ferrule 0.22 ... 4 mm ² Flexible with insulated ferrule 0.22 ... 4 mm ² Gauge A3-B3	24 ... 10 AWG 24 ... 12 AWG 24 ... 12 AWG	24 ... 10 AWG 24 ... 12 AWG 24 ... 12 AWG	Rail TH 35-7.5, TH 35-15 11 mm 0.433 in Wire stripping length
2 conductors per clamp Rigid: Solid/Stranded 0.2 ... 2.5 mm ² Flexible without ferrule 0.2 ... 2.5 mm ² Flexible with twin ferrule 0.22 ... 2.5 mm ²	24 ... 14 AWG 24 ... 14 AWG 24 ... 14 AWG	24 ... 14 AWG 24 ... 14 AWG 24 ... 14 AWG	Tool Flat screwdriver Ø 3.5 mm Ø 0.138 in
Disconnect circuit Rated current / Rated cross section 6.3 A / 4 mm ²	12 A / 10 AWG	12 A / 10 AWG	Torque 0.6 Nm ± 0.1 5.31 lb.in ± 0.885
Feed-through circuit Rated current / Rated cross section 32 A / 4 mm ²	30 A / 10 AWG	30 A / 10 AWG	
Rated voltage 800 V Impulse withstand voltage 8000 V Protection IP20	800 V 8000 V IP20	300 V NEMA 1	

Separate arrangement 	Assembly composed of 1 fuse terminal block in between non fuse terminal blocks	Overload and short-circuit protection 2.5 W Exclusive short-circuit protection 4 W
Compound arrangement 	Assembly composed of 5 fuse terminal blocks	Overload and short-circuit protection 1.6 W Exclusive short-circuit protection 4 W

The connecting capacity data for one Rigid: Solid/Stranded, or one Flexible conductor (when applicable) is a mandatory information required by IEC, UL and CSA standards (Copper conductors). All other data are provided as supplementary information only. For more details, please consult our CB, UL or CSA certificates and technical datasheet available on <http://www.TE.com>

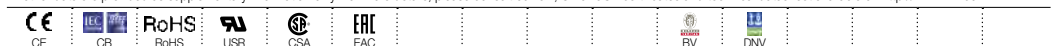

Accessories



Description	Color	Type	Part Number	Pkg qty	Weight (1 pce) g	
1 End stops 10 mm 0.394 in	Dark grey	BAZH1	1SNK900102R0000	20	24.00	
2 End sections 2.5 mm 0.098 in	Dark grey	ES4-D2-SF1	1SNK508911R0000	20	5.00	
3 Jumper bars	Orange	2 poles 57 A (IEC)	JB8-2	1SNK908302R0000	50	2.70
		3 poles 57 A (IEC)	JB8-3	1SNK908303R0000	50	4.10
		4 poles 57 A (IEC)	JB8-4	1SNK908304R0000	50	5.60
		5 poles 57 A (IEC)	JB8-5	1SNK908305R0000	40	7.00
		10 poles 57 A (IEC)	JB8-10	1SNK908310R0000	20	14.20
4 Lateral jumper bars 10 poles 35 A (IEC)	Grey	PC81-10	1SNA173523R1100	10	5.00	
5 Test adapters	Dark grey	For test plugs DIA 2 mm 0.079 in	TP2	1SNK900203R0000	20	1.70
		For test plugs DIA 4 mm 0.157 in	TP4	1SNK900205R0000	20	2.40
6 Test connectors	Dark grey	5.2 mm 0.205 in spacing	TC5	1SNK900200R0000	10	5.20
		End module, 5.2 mm 0.205 in	TC5-R1	1SNK900201R0000	10	5.20
7 Spacers 2.8 mm 0.110 in	Dark grey	ES-TC8	1SNK900104R0000	10	1.40	
8 Assembly rods	Dark grey	2 poles	TGA8	1SNA168672R1100	10	1.00
		3 poles	TGA8	1SNA168673R1200	10	1.50
		4 poles	TGA8	1SNA168674R1300	10	2.00
9 Terminal block markers	White	Blank marker	MG-CPM 13 41791	1SNB041791R0612	1680	0.27
		Blank card	MC812	1SNK160000R0000	22	10.00
			MC812PA	1SNK169999R0000	20	14.00
		Universal wire markers holder	UMH	1SNK900611R0000	10	0.20

Complete list of accessories is indicated in the terminal block datasheet including end stops.

Some accessories such as jumper bars may modify the terminal block's ratings: Complete information available in the accessories section of the catalog.

Technical data valid for copper conductors only.

ZS4-T3 screw clamp terminal blocks

Triple deck with 3 feed-through circuits - 5.2 mm 0.205 in spacing



ZS4-T3

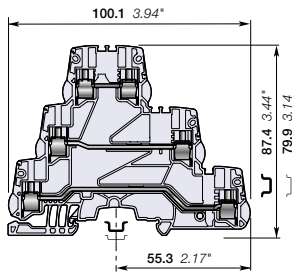

5.2 mm 0.205 in spacing

Description

Save space: 3 independent circuits in just 5.2 mm 0.205 in spacing,

- Fit many applications: space constraints, multiple signals distribution, sensors distribution, thanks to the jumper channels available on each deck.

Ordering details

Description	Color	Type	Part Number	Pkg qty	Weight (1 pce) g
Feed-through 3 feed-through circuits	Grey <input type="checkbox"/>	ZS4-T3	1SNK505212R0000	25	24.40

Main technical data

Connecting capacity		IEC	UL - CSA	Mounting instructions	
1 conductor per clamp	Rigid: Solid/Stranded	0.2 ... 4 mm ²	24 ... 12 AWG	Rail	TH 35-7.5, TH 35-15
	Flexible without ferrule	0.22 ... 4 mm ²		Wire stripping length	10.5 mm 0.413 in
	Flexible with non insulated ferrule	0.22 ... 4 mm ²	24 ... 12 AWG		
	Flexible with insulated ferrule	0.22 ... 2.5 mm ²	24 ... 14 AWG		
Gauge		A3-B3		Tool	Flat screwdriver Ø 3.5 mm Ø 0.138 in
2 conductors per clamp	Rigid: Solid/Stranded	0.2 ... 1.5 mm ²	24 ... 16 AWG		
	Flexible without ferrule	0.2 ... 1.5 mm ²			
	Flexible with twin ferrule	0.22 ... 1.5 mm ²	24 ... 16 AWG		
Rated current / Rated cross section		32 A / 4 mm ²	20 A / 12 AWG	Torque	0.6 Nm ± 0.1 5.31 lb.in ± 0.885
Rated short-time withstand current (1s)		480 A			
Rated voltage		800 V	300 V		
Impulse withstand voltage		8000 V			
Protection		IP20	NEMA 1		

The connecting capacity data for one Rigid: Solid/Stranded, or one Flexible conductor (when applicable) is a mandatory information required by IEC, UL and CSA standards (Copper conductors). All other data are provided as supplementary information only. For more details, please consult our CB, UL or CSA certificates and technical datasheet available on <http://www.TE.com>

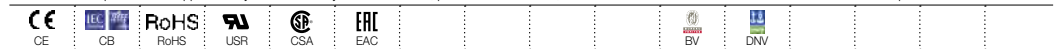

Accessories

Description	Color	Type	Part Number	Pkg qty	Weight (1 pce) g	
1 End stops 10 mm 0.394 in	Dark grey <input type="checkbox"/>	BAZH1	1SNK900102R0000	20	24.00	
2 End sections 0.8 mm 0.031 in	Dark grey <input type="checkbox"/>	ES4-T3	1SNK505961R0000	20	4.20	
3 Jumper bars	Orange <input type="checkbox"/>	2 poles 32 A (IEC)	JB5-2	1SNK905302R0000	50	1.30
		3 poles 32 A (IEC)	JB5-3	1SNK905303R0000	50	2.00
		4 poles 32 A (IEC)	JB5-4	1SNK905304R0000	50	2.70
		5 poles 32 A (IEC)	JB5-5	1SNK905305R0000	50	3.50
		10 poles 32 A (IEC)	JB5-10	1SNK905310R0000	30	7.10
		50 poles 32 A (IEC)	JB5-50	1SNK905350R0000	10	36.00
4 Test adapters	Dark grey <input type="checkbox"/>	For test plugs DIA 2 mm 0.079 in	TP2	1SNK900203R0000	20	1.70
		For test plugs DIA 4 mm 0.157 in	TP4	1SNK900205R0000	20	2.40
5 Label holders	Dark grey <input type="checkbox"/>	LH-J	1SNK900606R0000	100	0.73	
6 Terminal block markers	White <input type="checkbox"/>	Blank marker	MG-CPM 13 41790	1SNB041790R0512	1960	0.23
		Blank card	MC512	1SNK140000R0000	22	9.00
			MC512PA	1SNK149999R0000	20	10.00
		Universal wire markers holder	Grey <input type="checkbox"/>	UMH	1SNK900611R0000	10

Complete list of accessories is indicated in the terminal block datasheet including end stops.

Some accessories such as jumper bars may modify the terminal block's ratings: Complete information available in the accessories section of the catalog.

Technical data valid for copper conductors only.

ZS4-T3-R1 screw clamp terminal blocks

Triple deck with 3 feed-through circuits - 6 mm 0.236 in spacing

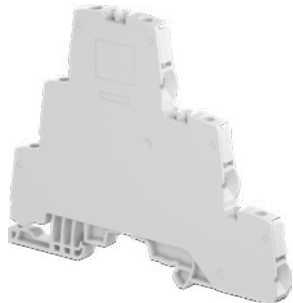

ZS4-T3-R1

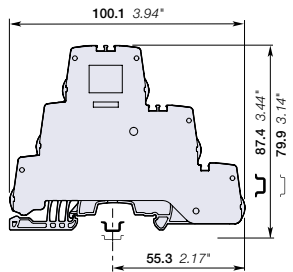

6 mm 0.236 in spacing

Description

Unique triple deck solution combining increased connecting capacity (up to 4 mm² with ferrule) and jumper channel available on each deck,

- Fit many applications: space constraints, multiple signals distribution, sensors distribution,
- Closed terminal block: no end section needed, optimized rigidity.

Ordering details

Description	Color	Type	Part Number	Pkg qty	Weight (1 pce) g
Feed-through Closed block with 3 feed-through circuits	Grey <input type="checkbox"/>	ZS4-T3-R1	1SNK506213R0000	50	28.30

Main technical data

Connecting capacity		IEC	UL - CSA	Mounting instructions	
1 conductor per clamp	Rigid: Solid/Stranded	0.2 ... 4 mm ²	24 ... 10 AWG	Rail	TH 35-7.5, TH 35-15
	Flexible without ferrule	0.22 ... 4 mm ²		Wire stripping length	10.5 mm 0.413 in
	Flexible with non insulated ferrule	0.22 ... 4 mm ²	24 ... 12 AWG		
	Flexible with insulated ferrule	0.22 ... 4 mm ²	24 ... 12 AWG		
	Gauge	A3-B3			
2 conductors per clamp	Rigid: Solid/Stranded	0.2 ... 1.5 mm ²	24 ... 16 AWG	Tool	Flat screwdriver Ø 3.5 mm Ø 0.138 in
	Flexible without ferrule	0.2 ... 1.5 mm ²			
	Flexible with twin ferrule	0.22 ... 1.5 mm ²	24 ... 16 AWG		
Rated current / Rated cross section		32 A / 4 mm ²	30 A / 10 AWG	Torque	0.6 Nm ± 0.1 5.31 lb.in ± 0.885
Rated short-time withstand current (1s)		480 A			
Rated voltage		800 V	300 V		
Impulse withstand voltage		8000 V			
Protection		IP20	NEMA 1		

The connecting capacity data for one Rigid: Solid/Stranded, or one Flexible conductor (when applicable) is a mandatory information required by IEC, UL and CSA standards (Copper conductors). All other data are provided as supplementary information only. For more details, please consult our CB, UL or CSA certificates and technical datasheet available on <http://www.TE.com>

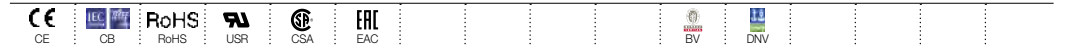

Accessories

Description	Color	Type	Part Number	Pkg qty	Weight (1 pce) g	
1 End stops	Dark grey <input checked="" type="checkbox"/>	BAZH1	1SNK900102R0000	20	24.00	
2 Jumper bars	Orange <input checked="" type="checkbox"/>	JB6-2	1SNK906302R0000	50	1.30	
		JB6-3	1SNK906303R0000	50	2.10	
		JB6-4	1SNK906304R0000	50	2.90	
		JB6-5	1SNK906305R0000	50	3.60	
		JB6-10	1SNK906310R0000	20	7.40	
3 Test adapters	Dark grey <input checked="" type="checkbox"/>	For test plugs DIA 2 mm 0.079 in	TP2	1SNK900203R0000	20	1.70
		For test plugs DIA 4 mm 0.157 in	TP4	1SNK900205R0000	20	2.40
4 Label holders	Dark grey <input checked="" type="checkbox"/>	LH-J	1SNK900606R0000	100	0.73	
5 Terminal block markers	White <input checked="" type="checkbox"/>	Blank marker	MG-CPM 13 41791	1SNB041791R0612	1680	0.27
		Blank card	MC512	1SNK140000R0000	22	9.00
			MC512PA	1SNK149999R0000	20	10.00
		Universal wire markers holder	Grey <input type="checkbox"/>	UMH	1SNK900611R0000	10

Complete list of accessories is indicated in the terminal block datasheet including end stops. Some accessories such as jumper bars may modify the terminal block's ratings: Complete information available in the accessories section of the catalog.

Technical data valid for copper conductors only.

ZS4-D-CH-UD screw clamp terminal blocks

Component holder - 5.2 mm 0.205 in spacing

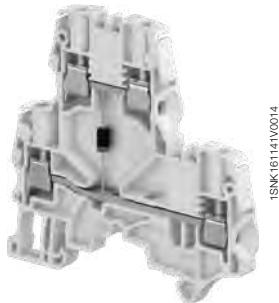

ZS4-D-CH

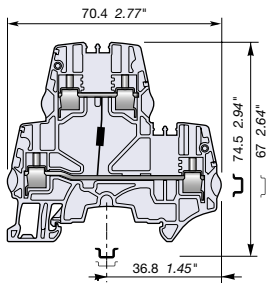

5.2 mm 0.205 in spacing

Description

Protect your circuit with one 1N4007 diode.

Ordering details

Description	Color	Type	Part Number	Pkg qty	Weight (1 pce) g
Component holder Cathode of the blocking diode connected to the lower circuit	Grey <input type="checkbox"/>	ZS4-D-CH-UD	1SNK505214R0000	50	15.30

Main technical data

Connecting capacity		IEC	UL - CSA	Mounting instructions	
1 conductor per clamp	Rigid: Solid/Stranded	0.2 ... 4 mm ²	24 ... 12 AWG	Rail	TH 35-7.5, TH 35-15
	Flexible without ferrule	0.22 ... 4 mm ²		Wire stripping length	10 mm 0.393 in
	Flexible with non insulated ferrule	0.22 ... 4 mm ²	24 ... 12 AWG	Tool	Flat screwdriver Ø 3.5 mm Ø 0.138 in
	Flexible with insulated ferrule	0.22 ... 2.5 mm ²	24 ... 14 AWG		
Gauge		A3-B3		Torque	0.6 Nm ± 0.1 5.31 lb.in ± 0.885
2 conductors per clamp	Rigid: Solid/Stranded	0.2 ... 1.5 mm ²	24 ... 16 AWG		
		Flexible without ferrule	0.2 ... 1.5 mm ²		
		Flexible with twin ferrule	0.22 ... 1.5 mm ²		
Rated current / Rated cross section		29 A / 4 mm ²	20 A / 12 AWG		
Rated short-time withstand current (1s)		480 A			
Short Circuit Current Rating (with specific conditions)					
Rated voltage		800 V	300 V		
Impulse withstand voltage					
Protection		IP20	NEMA 1		

The connecting capacity data for one Rigid: Solid/Stranded, or one Flexible conductor (when applicable) is a mandatory information required by IEC, UL and CSA standards (Copper conductors). All other data are provided as supplementary information only. For more details, please consult our CB, UL or CSA certificates and technical datasheet available on <http://www.TE.com>

--	--	--	--	--

Accessories

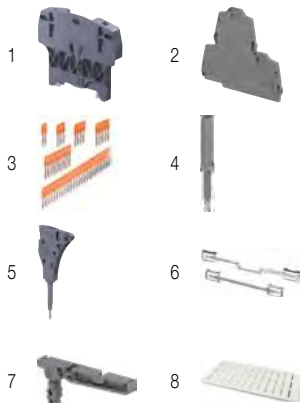

Description	Color	Type	Part Number	Pkg qty	Weight (1 pce) g	
1 End stops	Dark grey <input checked="" type="checkbox"/>	BAZH1	1SNK900102R0000	20	24.00	
2 End sections	Dark grey <input checked="" type="checkbox"/>	ES4-D2	1SNK505960R0000	20	4.10	
3 Jumper bars	Orange <input checked="" type="checkbox"/>	2 poles	JB5-2	1SNK905302R0000	50	1.30
		3 poles	JB5-3	1SNK905303R0000	50	2.00
		4 poles	JB5-4	1SNK905304R0000	50	2.70
		5 poles	JB5-5	1SNK905305R0000	50	3.50
		10 poles	JB5-10	1SNK905310R0000	30	7.10
4 Test adapters	Dark grey <input checked="" type="checkbox"/>	For test plugs DIA 2 mm 0.079 in	TP2	1SNK900203R0000	20	1.70
		For test plugs DIA 4 mm 0.157 in	TP4	1SNK900205R0000	20	2.40
5 Test connectors	Dark grey <input checked="" type="checkbox"/>	5.2 mm 0.205 in spacing	TC5	1SNK900200R0000	10	5.20
		End module, 5.2 mm 0.205 in	TC5-R1	1SNK900201R0000	10	5.20
6 Shield connectors		SHB	1SNK900602R0000	20	4.90	
7 Label holders	Dark grey <input checked="" type="checkbox"/>	LH-J	1SNK900606R0000	100	0.73	
8 Terminal block markers	White <input type="checkbox"/>	MG-CPM 13 41790	1SNB041790R0512	1960	0.23	
		MC512	1SNK140000R0000	22	9.00	
		MC512PA	1SNK149999R0000	20	10.00	
		Grey <input type="checkbox"/>	UMH	1SNK900611R0000	10	0.20

Complete list of accessories is indicated in the terminal block datasheet including end stops. Some accessories such as jumper bars may modify the terminal block's ratings: Complete information available in the accessories section of the catalog.

Technical data valid for copper conductors only.

ZS4-D-CH-DU screw clamp terminal blocks

Component holder - 5.2 mm 0.205 in spacing

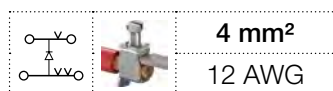

ZS4-D-CH

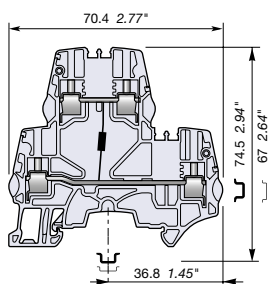

5.2 mm 0.205 in spacing

Description

Protect your circuit with one 1N4007 diode.

Ordering details

Description	Color	Type	Part Number	Pkg qty	Weight (1 pce) g
Component holder Cathode of the blocking diode connected to the upper circuit	Grey <input type="checkbox"/>	ZS4-D-CH-DU	1SNK505215R0000	50	15.30

Main technical data

Connecting capacity		IEC	UL - CSA	Mounting instructions	
1 conductor per clamp	Rigid: Solid/Stranded	0.2 ... 4 mm ²	24 ... 12 AWG	Rail	TH 35-7.5, TH 35-15
	Flexible without ferrule	0.22 ... 4 mm ²		Wire stripping length	10 mm 0.393 in
	Flexible with non insulated ferrule	0.22 ... 4 mm ²	24 ... 12 AWG	Tool	Flat screwdriver Ø 3.5 mm Ø 0.138 in
	Flexible with insulated ferrule	0.22 ... 2.5 mm ²	24 ... 14 AWG		
Gauge		A3-B3		Torque	0.6 Nm ± 0.1 5.31 lb.in ± 0.885
2 conductors per clamp		0.2 ... 1.5 mm ²	24 ... 16 AWG		
Rated current / Rated cross section		29 A / 4 mm ²	20 A / 12 AWG		
Rated short-time withstand current (1s)		480 A			
Short Circuit Current Rating (with specific conditions)					
Rated voltage		800 V	300 V		
Impulse withstand voltage					
Protection		IP20	NEMA 1		

The connecting capacity data for one Rigid: Solid/Stranded, or one Flexible conductor (when applicable) is a mandatory information required by IEC, UL and CSA standards (Copper conductors). All other data are provided as supplementary information only. For more details, please consult our CB, UL or CSA certificates and technical datasheet available on <http://www.TE.com>

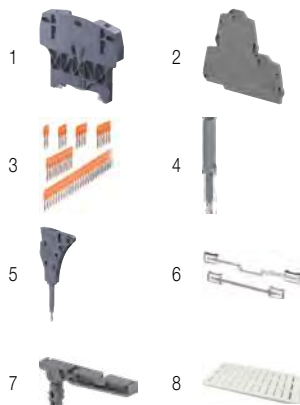
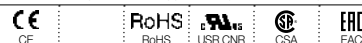

Accessories

Description	Color	Type	Part Number	Pkg qty	Weight (1 pce) g	
1 End stops	Dark grey <input checked="" type="checkbox"/>	BAZH1	1SNK900102R0000	20	24.00	
2 End sections	Dark grey <input checked="" type="checkbox"/>	ES4-D2	1SNK505960R0000	20	4.10	
3 Jumper bars	Orange <input checked="" type="checkbox"/>	2 poles	JB5-2	1SNK905302R0000	50	1.30
		3 poles	JB5-3	1SNK905303R0000	50	2.00
		4 poles	JB5-4	1SNK905304R0000	50	2.70
		5 poles	JB5-5	1SNK905305R0000	50	3.50
		10 poles	JB5-10	1SNK905310R0000	30	7.10
		50 poles	JB5-50	1SNK905350R0000	10	36.00
4 Test adapters	Dark grey <input checked="" type="checkbox"/>	For test plugs DIA 2 mm 0.079 in	TP2	1SNK900203R0000	20	1.70
		For test plugs DIA 4 mm 0.157 in	TP4	1SNK900205R0000	20	2.40
5 Test connectors	Dark grey <input checked="" type="checkbox"/>	5.2 mm 0.205 in spacing	TC5	1SNK900200R0000	10	5.20
		End module, 5.2 mm 0.205 in	TC5-R1	1SNK900201R0000	10	5.20
6 Shield connectors		SHB	1SNK900602R0000	20	4.90	
7 Label holders	Dark grey <input checked="" type="checkbox"/>	LH-J	1SNK900606R0000	100	0.73	
8 Terminal block markers	White <input type="checkbox"/>	Blank marker	MG-CPM 13 41790	1SNB041790R0512	1960	0.23
		Blank card	MC512	1SNK140000R0000	22	9.00
			MC512PA	1SNK149999R0000	20	10.00
	Universal wire markers holder	Grey <input type="checkbox"/>	UMH	1SNK900611R0000	10	0.20

Complete list of accessories is indicated in the terminal block datasheet including end stops. Some accessories such as jumper bars may modify the terminal block's ratings: Complete information available in the accessories section of the catalog.

Technical data valid for copper conductors only.

SNK series, terminal blocks

Screw clamp technology - Test & measurement



Secure your measurement operations

The new ZS10-ST test & measurement terminal blocks benefit from our long experience in the energy applications and from the SNK features: performances, ergonomics, common accessories and marking.

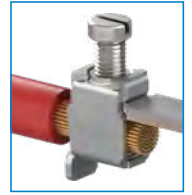

High performances

- 10 mm² 6 AWG
- 6 mm² 10 AWG with ferrule
- 50 A (IEC) 53 A (UL)
- Worldwide certifications



Rely on our smart design

Insulated short circuit bridges:
SC-JB8

Insulated captive test sockets:
AJS9
6 colors
compatible with standard
DIA. 4 mm test plugs
(IEC 60010-031)

Circuit separators: CS
For visual separation between
CT & PT circuits

Protecting cover kits: KCO

New ground terminal block:
ZS10-PE-R1

Lateral jumper bar: PC8
For CT or PT commoning

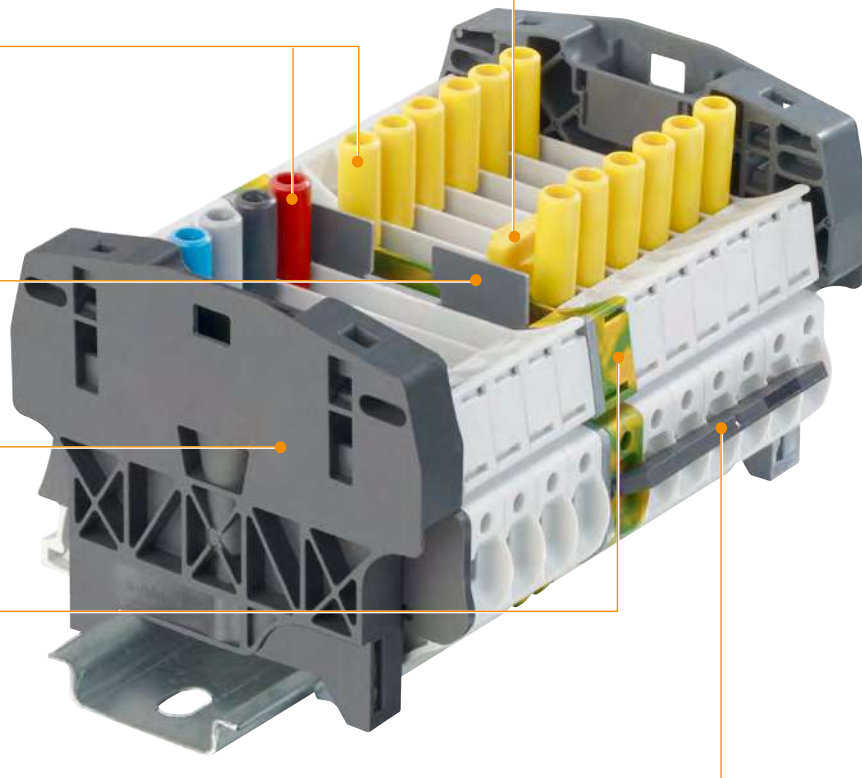

1SNK160057S0201



Assembly with protecting cover



Drilling and centering guide

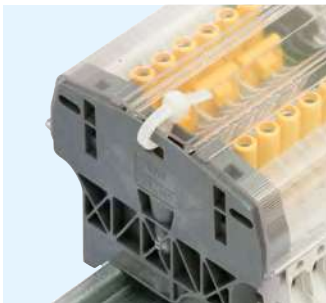

Seal with cable tie



Convenient removal with screwdriver

Guarantee access only to authorized operators

cover can be permanently sealed with a seal or cable tie.

Centering drilling guide for seal or cable tie.

The cover is specially designed to ease its mounting or removal:

- Hook shape on each side for convenient removal with screwdriver

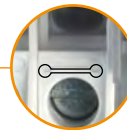
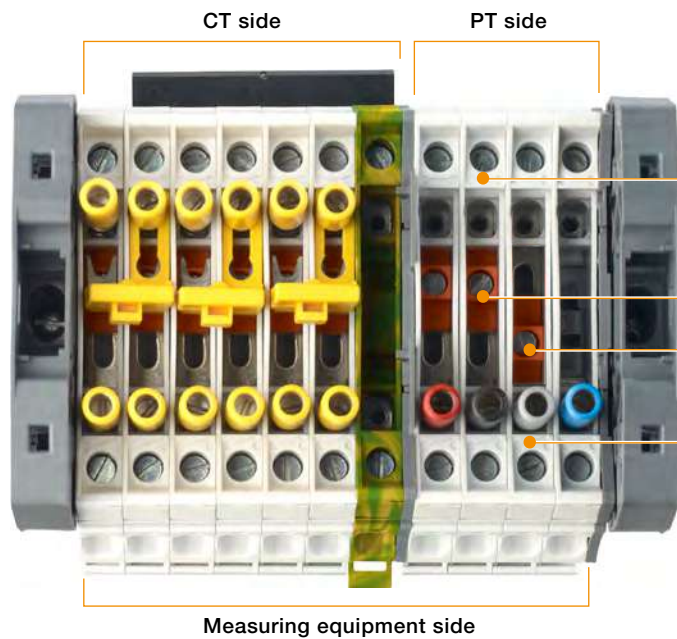

sliding link status: closed

Disconnect sliding link status:

Open and close symbols help to visualize the sliding link position

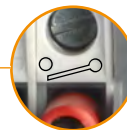

sliding link status: opened



1



2



3

Short-circuit CT circuits safely and conveniently

- 1 Fully operated by screwdriver (DIA 3.5 mm)
- 2 Short-circuited position secured thanks to AJS9 test sockets tightening
- 3 Adapted hook shape maintain the bridge on terminal block in the non connected position

SNK series, terminal blocks

Test & measurement - Typical schematic for measuring devices

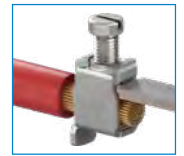

Common point on the transformers

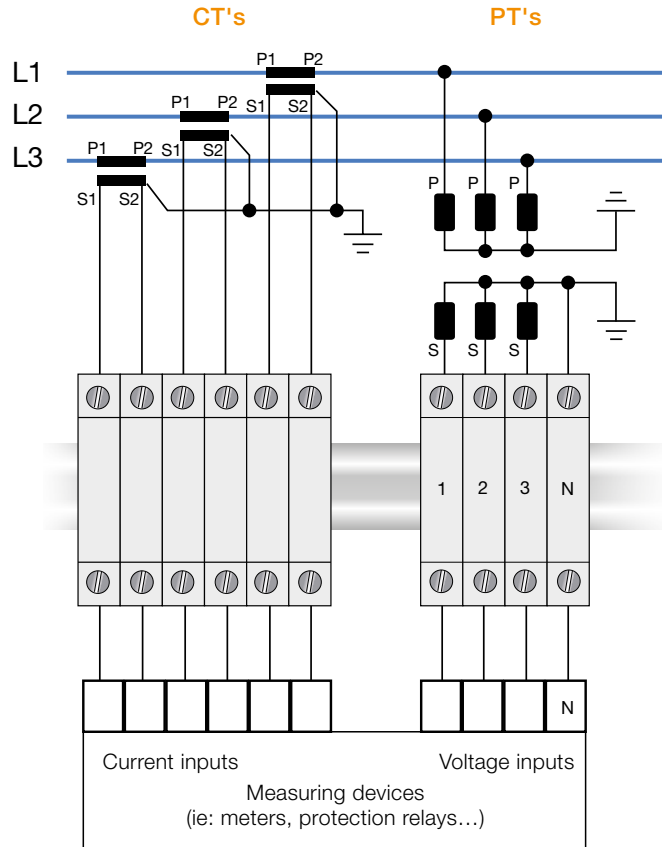

Bill of material optimized

Bill of material with convenient customization (test sockets, feed-through terminals...)

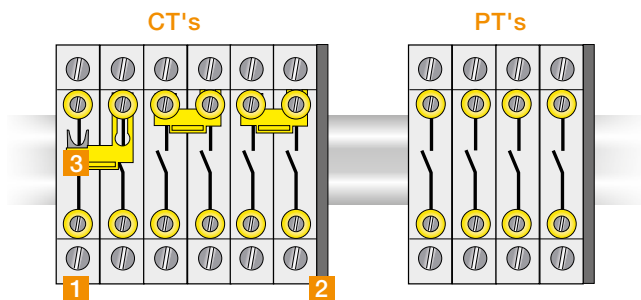

Description	Type	Order code	Qty needed	
			CT's	PT's
1 Terminal block	ZS10-ST-T4	1SNK508311R0000	6	4
2 End section	ES10-ST	1SNK508910R0000	1	1
3 Short-circuit bridges	SC-JB8-2	1SNK900652R0000	3	0

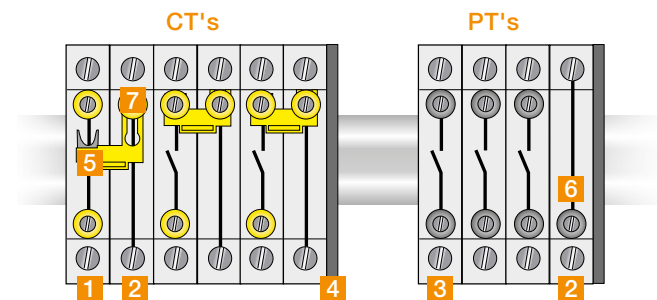

Description	Type	Order code	Qty needed	
			CT's	PT's
1 Terminal block	ZS10-ST-T4	1SNK508311R0000	3	0
2 Terminal block	ZS10-R1	1SNK508011R0000	3	1
3 Terminal block	ZS10-ST-1	1SNK508312R0000	0	3
4 End section	ES10-ST	1SNK508910R0000	1	1
5 Short-circuit bridges	SC-JB8-2	1SNK900652R0000	3	0
6 Test socket	AL4-M3	1SNA206721R0100	0	1
7 Insulated test socket	AJS9	1SNA179726R0200	3	0

1SNK160058S0201

SNK series, terminal blocks

Test & measurement - Typical schematic for measuring devices

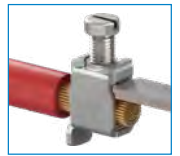

Common point on the terminal block assembly

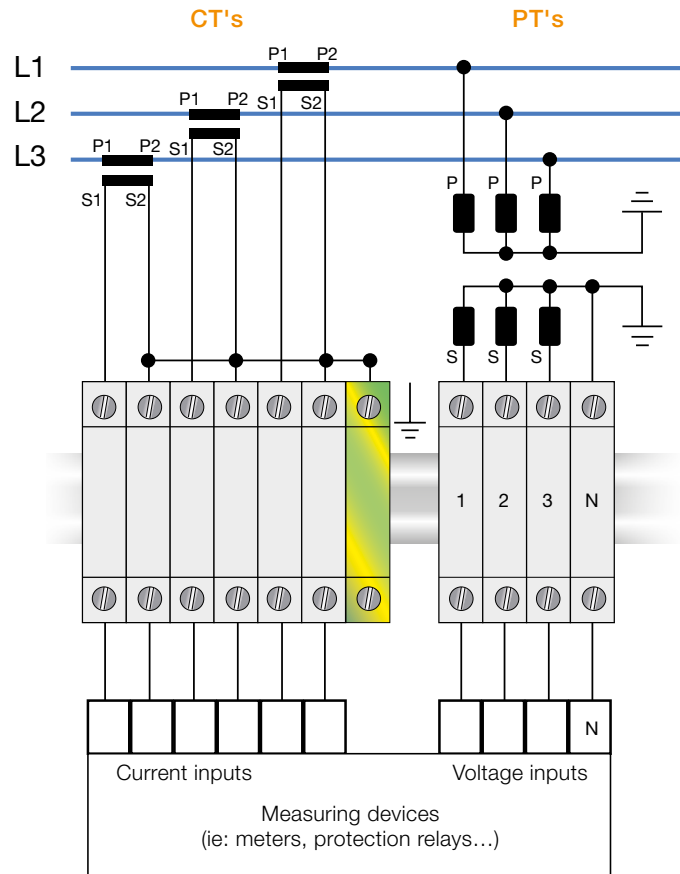

Bill of material optimized

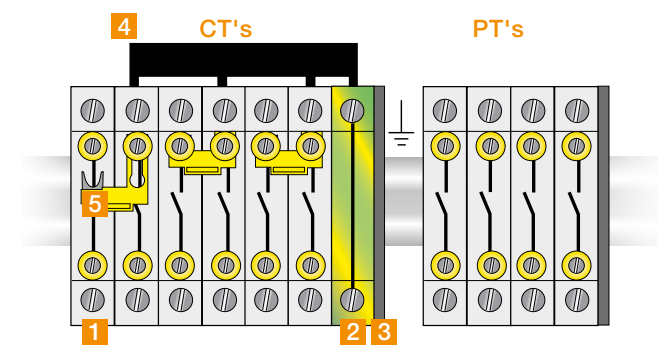

Description	Type	Order code	Qty needed	
			CT's	PT's
1 Terminal block	ZS10-ST-T4	1SNK508311R0000	6	4
2 Terminal block	ZS10-PE-R1	1SNK508151R0000	1	0
3 End section	ES10-ST	1SNK508910R0000	1	1
4 Lateral jumper bars	PC8-R1	1SNA400711R0600	1	0
5 Short-circuit bridges	SC-JB8-2	1SNK900652R0000	3	0

Bill of material with convenient customization (test sockets, feed-through terminals...)

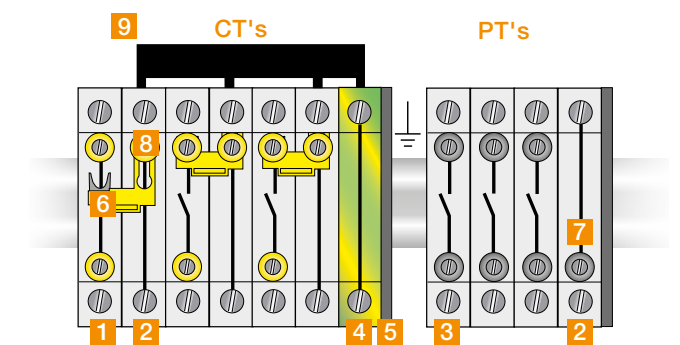

Description	Type	Order code	Qty needed	
			CT's	PT's
1 Terminal block	ZS10-ST-T4	1SNK508311R0000	3	0
2 Terminal block	ZS10-R1	1SNK508011R0000	3	1
3 Terminal block	ZS10-ST-1	1SNK508312R0000	0	3
4 Terminal block	ZS10-PE-R1	1SNK508151R0000	1	0
5 End section	ES10-ST	1SNK508910R0000	1	1
6 Short-circuit bridges	SC-JB8-2	1SNK900652R0000	3	0
7 Test socket	AL4-M3	1SNA206721R0100	0	1
8 Insulated test socket	AJS9	1SNA179726R0200	3	0
9 Lateral jumper bars	PC8-R1	1SNA400711R0600	1	0

8

1SNK160058S0201

ZS10-ST screw clamp terminal blocks

Test disconnect with sliding link - 8 mm 0.315 in spacing



ZS10-ST

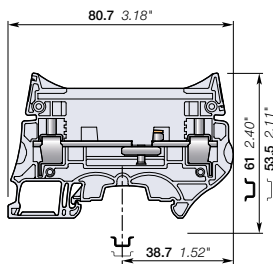

8 mm 0.315 in spacing

Description

- Secure your disconnect operations in control circuits with the robust sliding link operated with a screwdriver,
- Customize ZS10-ST with colored test sockets in order to identify conveniently each phase of the Current Transformer or Potential Transformers secondary circuits,
- Fully compatible with the ZS10-ST-T4 accessories.

Ordering details

Description	Color	Type	Part Number	Pkg qty	Weight (1 pce)
Disconnect	Grey	ZS10-ST	1SNK508310R0000	25	24.80

Main technical data

Connecting capacity		IEC	UL - CSA	Mounting instructions	
1 conductor per clamp	Rigid: Solid/Stranded	0.5 ... 10 mm ²	24 ... 6 AWG	Rail	TH 35-7.5, TH 35-15
	Flexible without ferrule	0.5 ... 10 mm ²		Wire stripping length	13 mm 0.512 in
	Flexible with non insulated ferrule	0.5 ... 10 mm ²	24 ... 8 AWG	Screw clamp Tool	Flat screwdriver Ø 3.5 mm Ø 0.138 in
	Flexible with insulated ferrule	0.5 ... 6 mm ²	24 ... 10 AWG		
2 conductors per clamp	Rigid: Solid/Stranded	0.5 ... 4 mm ²	20 ... 12 AWG	Torque	1.3 Nm ± 0.3 11.5 lb.in ± 2.65
	Flexible without ferrule	0.5 ... 4 mm ²			
	Flexible with twin ferrule	0.5 ... 4 mm ²	20 ... 12 AWG		
Rated current / Rated cross section		50 A / 10 mm ²	53 A / 6 AWG	Disconnect device Tool	Flat screwdriver Ø 3.5 mm Ø 0.138
Rated short-time withstand current (1s)		1200 A			
Rated voltage		630 V	300 V	Torque	0.4 Nm ... 0.6 Nm 3.5 lb.in ... 5.3 lb.in
Impulse withstand voltage		8000 V			
Protection		IP20	NEMA 1		

The connecting capacity data for one Rigid: Solid/Stranded, or one Flexible conductor (when applicable) is a mandatory information required by IEC, UL and CSA standards (Copper conductors). All other data are provided as supplementary information only. For more details, please consult our CB, UL or CSA certificates and technical datasheet available on <http://www.TE.com>

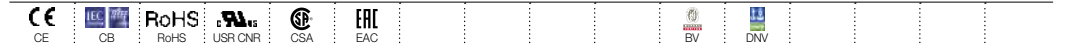

Accessories

Description	Color	Type	Part Number	Pkg qty	Weight (1 pce)	
1 End stops	Dark grey	BAM4	1SNK900001R0000	50	14.00	
2 End sections	Dark grey	ES10-ST	1SNK508910R0000	20	3.5	
3 Jumper bars	Orange	2 poles 50 A (IEC)	JB8-2-R1	1SNK908902R0000	10	7.6
		3 poles 50 A (IEC)	JB8-3-R1	1SNK908903R0000	10	11.6
		4 poles 50 A (IEC)	JB8-4-R1	1SNK908904R0000	10	15.5
		5 poles 50 A (IEC)	JB8-5-R1	1SNK908905R0000	10	19.4
		10 poles 50 A (IEC)	JB8-10-R1	1SNK908910R0000	10	39.00
4 Circuit separators	Dark grey	CS-R3	1SNK900107R0000	20	6.40	
5 Test sockets	Yellow	AJS9	1SNA179726R0200	25	3.60	
	Black	AJS9-BK	1SNA206680R1500	25	3.60	
	Green	AJS9-GN	1SNA206681R0200	25	3.60	
	Grey	AJS9-GR	1SNA206682R0300	25	3.60	
	Blue	AJS9-BL	1SNA206683R0400	25	3.60	
	Red	AJS9-RD	1SNA206720R1400	25	3.60	
	White	AJS9-WH	1SNA206765R0000	25	3.60	
	Purple	AJS9-PR	1SNA206772R0000	25	3.60	
	Brown	AJS9-BR	1SNA206782R0000	25	3.60	
			AL4-M3	1SNA206721R0100	50	1.10
6 Terminal block markers	White	MG-CPM 13 41791	1SNB041791R0612	1680	0.27	
		MC812	1SNK160000R0000	22	10.00	
		MC812PA	1SNK169999R0000	20	14.00	
		Universal wire markers holder	UMH	1SNK900611R0000	10	0.20

Complete list of accessories is indicated in the terminal block datasheet including end stops. Some accessories such as jumper bars may modify the terminal block's ratings. Complete information available in the accessories section of the catalog.

Screw clamp terminal blocks

Description	Color	Type	Part Number	Pkg qty	Weight (1 pce)
Feed-through	Grey	ZS10-R1	1SNK508011R0000	25	20.90
Ground	Green-yellow	ZS10-PE-R1	1SNK508151R0000	25	28.40



ZS10-R1



ZS10-PE-R1

Technical data valid for copper conductors only.

ZS10-ST-1 screw clamp terminal blocks

Test disconnect with sliding link for Potential Transformer circuits - 8 mm 0.315 in spacing



10 mm²
6 AWG

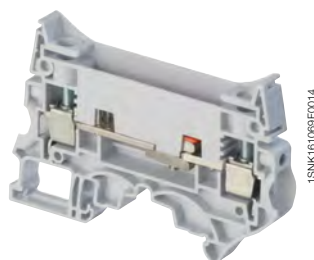

1SNK161069F0014

ZS10-ST-1

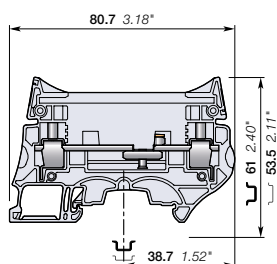

8 mm 0.315 in spacing

Description

Test terminal blocks especially designed for Potential Transformers circuits:

- low profile voltage measurement thanks to the two compact built-in test sockets compatible with DIA 4 mm 0.157 in test plugs,
- Installed with our aligned feed-through and ground terminal blocks, you benefit of a complete and compact solution for your PT circuits.

Ordering details

Description	Color	Type	Part Number	Pkg qty	Weight (1 pce) g
Disconnect With 2 test sockets DIA 4 mm 0.157 in	Grey <input type="checkbox"/>	ZS10-ST-1	1SNK508312R0000	25	27.00

Main technical data

Connecting capacity		IEC	UL - CSA	Mounting instructions	
1 conductor per clamp	Rigid: Solid/Stranded	0.5 ... 10 mm ²	24 ... 6 AWG	Rail	TH 35-7.5, TH 35-15
	Flexible without ferrule	0.5 ... 10 mm ²		Wire stripping length	13 mm 0.512 in
	Flexible with non insulated ferrule	0.5 ... 10 mm ²	24 ... 8 AWG	Screw clamp Tool	Flat screwdriver Ø 3.5 mm Ø 0.138 in
	Flexible with insulated ferrule	0.5 ... 6 mm ²	24 ... 10 AWG		
Gauge		A5-B5		Torque	1.3 Nm ± 0.3 11.5 lb.in ± 2.65
2 conductors per clamp	Rigid: Solid/Stranded	0.5 ... 4 mm ²	20 ... 12 AWG	Disconnect device Tool	Flat screwdriver Ø 3.5 mm Ø 0.138 in
	Flexible without ferrule	0.5 ... 4 mm ²			
	Flexible with twin ferrule	0.5 ... 4 mm ²	20 ... 12 AWG		
Rated current / Rated cross section		50 A / 10 mm ²	53 A / 6 AWG	Torque	0.4 Nm ... 0.6 Nm 3.5 lb.in ... 5.3 lb.in
Rated short-time withstand current (1s)		1200 A			
Rated voltage		630 V	300 V		
Impulse withstand voltage		8000 V			
Protection		IP10	NEMA 1		

The connecting capacity data for one Rigid: Solid/Stranded, or one Flexible conductor (when applicable) is a mandatory information required by IEC, UL and CSA standards (Copper conductors). All other data are provided as supplementary information only. For more details, please consult our CB, UL or CSA certificates and technical datasheet available on <http://www.TE.com>

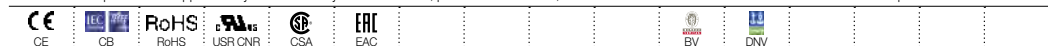

Accessories

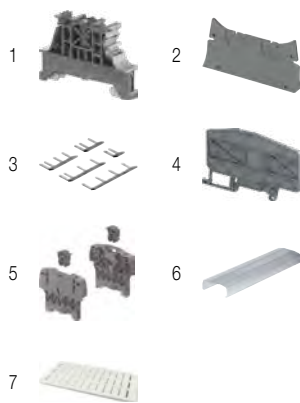

Description	Color	Type	Part Number	Pkg qty	Weight (1 pce) g
1 End stops 10 mm 0.394 in	Dark grey <input type="checkbox"/>	BAM4	1SNK900001R0000	50	14.00
2 End sections 2 mm 0.079 in	Dark grey <input type="checkbox"/>	ES10-ST	1SNK508910R0000	20	3.5
3 Lateral jumper bars 10 poles	Black <input type="checkbox"/>	PC8-10	1SNA163313R2400	10	14.00
		PC8-R1	1SNA400711R0600	10	6.60
		PC8-R2	1SNA400712R0700	10	7.80
		PC8-R3	1SNA400713R0000	10	9.00
		PC8-R4	1SNA400724R0300	10	4.50
		PC8-R5	1SNA400842R0000	10	6.60
		PC8-R6	1SNA400843R0000	10	6.60
		PC8-R7	1SNA400849R0000	10	6.60
PC8-R8	1SNA400850R0000	10	7.80		
4 Circuit separators 3 mm 0.118 in	Dark grey <input type="checkbox"/>	CS-R3	1SNK900107R0000	20	6.40
5 Protecting cover kits	Dark grey <input type="checkbox"/>	KCO	1SNK900624R0000	1	47.80
6 Protecting covers 1 m 39.4 in length	Transparent <input checked="" type="checkbox"/>	CO	1SNK900604R0000	1	300.00
7 Terminal block markers	White <input type="checkbox"/>	MG-CPM 13 41791	1SNB041791R0612	1680	0.27
		MC812	1SNK160000R0000	22	10.00
		MC812PA	1SNK169999R0000	20	14.00
Universal wire markers holder	Grey <input type="checkbox"/>	UMH	1SNK900611R0000	10	0.20

Complete list of accessories is indicated in the terminal block datasheet including end stops. Some accessories such as jumper bars may modify the terminal block's ratings. Complete information available in the accessories section of the catalog.

Screw clamp terminal blocks

Description	Color	Type	Part Number	Pkg qty	Weight (1 pce) g
Feed-through Profile aligned with ZS10-ST...	Grey <input type="checkbox"/>	ZS10-R1	1SNK508011R0000	25	20.90
Ground Profile aligned with ZS10-ST...	Green-yellow <input type="checkbox"/>	ZS10-PE-R1	1SNK508151R0000	25	28.40



ZS10-R1



ZS10-PE-R1

Technical data valid for copper conductors only.

ZS10-ST-T4 screw clamp terminal blocks

Test disconnect with sliding link for Current Transformer circuits - 8 mm 0.315 in spacing



ZS10-ST-T4

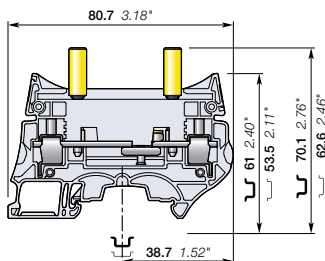

8 mm 0.315 in spacing

Description

Test terminal blocks especially designed for Current Transformers circuits:

- easy and safe current measurement thanks to the two insulated built-in test sockets compatible with IP20 DIA 4 mm 0.157 in test plugs (per IEC60101-031),
- convenient short-circuit operations with the SC-JB insulated sliding bridges.

Ordering details

Description	Color	Type	Part Number	Pkg qty	Weight (1 pce) g
Disconnect With two yellow test sockets DIA 4 mm 0.157 in	Grey <input type="checkbox"/>	ZS10-ST-T4	1SNK508311R0000	25	31.90

Main technical data

Connecting capacity		IEC	UL - CSA	Mounting instructions	
1 conductor per clamp	Rigid: Solid/Stranded	0.5 ... 10 mm ²	24 ... 6 AWG	Rail	TH 35-7.5, TH 35-15
	Flexible without ferrule	0.5 ... 10 mm ²	24 ... 8 AWG	Wire stripping length	13 mm 0.512 in
	Flexible with non insulated ferrule	0.5 ... 10 mm ²	24 ... 8 AWG	Screw clamp Tool	Flat screwdriver Ø 3.5 mm 0.138 in
	Flexible with insulated ferrule	0.5 ... 6 mm ²	24 ... 10 AWG		
Gauge		A5-B5		Torque	1.3 Nm ± 0.3 11.5 lb.in ± 2.65
2 conductors per clamp	Rigid: Solid/Stranded	0.5 ... 4 mm ²	20 ... 12 AWG	Disconnect device Tool	Flat screwdriver Ø 3.5 mm 0.138
	Flexible without ferrule	0.5 ... 4 mm ²	20 ... 12 AWG		
	Flexible with twin ferrule	0.5 ... 4 mm ²	20 ... 12 AWG		
Rated current / Rated cross section		50 A / 10 mm ²	53 A / 6 AWG	Torque	0.4 Nm ... 0.6 Nm 3.5 lb.in ... 5.3 lb.in
Rated short-time withstand current (1s)		1200 A			
Rated voltage		630 V	300 V	Test socket Tool	Flat screwdriver Ø 3.5 mm 0.138
Impulse withstand voltage		8000 V			
Protection		IP20	NEMA 1	Torque	0.4 Nm ... 0.6 Nm 3.5 lb.in ... 5.3 lb.in

The connecting capacity data for one Rigid: Solid/Stranded, or one Flexible conductor (when applicable) is a mandatory information required by IEC, UL and CSA standards (Copper conductors). All other data are provided as supplementary information only. For more details, please consult our CB, UL or CSA certificates and technical datasheet available on <http://www.TE.com>



Accessories

Description	Color	Type	Part Number	Pkg qty	Weight (1 pce) g	
1 End stops 10 mm 0.394 in	Dark grey <input type="checkbox"/>	BAM4	1SNK900001R0000	50	14.00	
2 End sections 2 mm 0.079 in	Dark grey <input type="checkbox"/>	ES10-ST	1SNK508910R0000	20	3.5	
3 Lateral jumper bars	Black <input type="checkbox"/>	10 poles	PC8-10	1SNA163313R2400	10	14.00
		4/6 poles	PC8-R1	1SNA400711R0600	10	6.60
		4/8 poles	PC8-R2	1SNA400712R0700	10	7.80
		4/10 poles	PC8-R3	1SNA400713R0000	10	9.00
		3/4 poles	PC8-R4	1SNA400724R0300	10	4.50
		4/7 poles	PC8-R5	1SNA400842R0000	10	6.60
		2/3 poles	PC8-R6	1SNA400843R0000	10	6.60
		4/6 poles	PC8-R7	1SNA400849R0000	10	6.60
4 Circuit separators 3 mm 0.118 in	Dark grey <input type="checkbox"/>	CS-R3	1SNK900107R0000	20	6.40	
5 Protecting cover kits	Dark grey <input type="checkbox"/>	KCO	1SNK900624R0000	1	47.80	
6 Protecting covers 1 m 39.4 in length	Transparent <input type="checkbox"/>	CO	1SNK900604R0000	1	300.00	
7 Short circuit bridges	Yellow <input type="checkbox"/>	2 poles	SC-JB8-2	1SNK900652R0000	25	2.00
		3 poles	SC-JB8-3	1SNK900653R0000	25	3.4
		4 poles	SC-JB8-4	1SNK900654R0000	25	4.7
8 Terminal block markers	White <input type="checkbox"/>	Blank marker	MG-CPM 13 41791	1SNB041791R0612	1680	0.27
		Blank card	MC812	1SNK160000R0000	22	10.00
			MC812PA	1SNK169999R0000	20	14.00
		Universal wire markers holder	Grey <input type="checkbox"/>	UMH	1SNK900611R0000	10

Complete list of accessories is indicated in the terminal block datasheet including end stops.

Some accessories such as jumper bars may modify the terminal block's ratings: Complete information available in the accessories section of the catalog.

Screw clamp terminal blocks

Description	Color	Type	Part Number	Pkg qty	Weight (1 pce) g
Feed-through Profile aligned with ZS10-ST...	Grey <input type="checkbox"/>	ZS10-R1	1SNK508011R0000	25	20.90
Ground Profile aligned with ZS10-ST...	Green-yellow <input type="checkbox"/>	ZS10-PE-R1	1SNK508151R0000	25	28.40



ZS10-R1

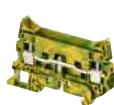

ZS10-PE-R1

Technical data valid for copper conductors only.

ZS10-R1 screw clamp terminal blocks

Feed-through - 8 mm 0.315 in spacing



ZS10-R1

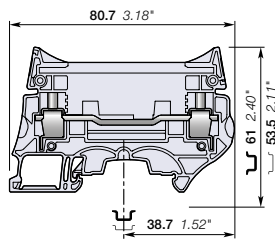

8 mm 0.315 in spacing

Description

- With the same profile as the ZS10-ST..., the feed-through ZS10-R1 allows you to fully implement the electrical drawing of your CT or PT circuits,
- Fully compatible with the ZS10-ST... accessories.

Ordering details

Description	Color	Type	Part Number	Pkg qty	Weight (1 pce) g
Feed-through Profile aligned with ZS10-ST..	Grey <input type="checkbox"/>	ZS10-R1	1SNK508011R0000	25	20.90

Main technical data

Connecting capacity		IEC	UL - CSA	Mounting instructions	
1 conductor per clamp	Rigid: Solid/Stranded	0.5 ... 10 mm²	24 ... 6 AWG	Rail	TH 35-7.5, TH 35-15
	Flexible without ferrule	0.5 ... 10 mm²		Wire stripping length	13 mm 0.512 in
	Flexible with non insulated ferrule	0.5 ... 10 mm²	24 ... 8 AWG		
	Flexible with insulated ferrule	0.5 ... 6 mm²	24 ... 10 AWG		
	Gauge	A5-B5			
2 conductors per clamp	Rigid: Solid/Stranded	0.5 ... 4 mm²	20 ... 12 AWG	Tool	Flat screwdriver Ø 3.5 mm Ø 0.138 in
	Flexible without ferrule	0.5 ... 4 mm²			
	Flexible with twin ferrule	0.5 ... 4 mm²	20 ... 12 AWG		
Rated current / Rated cross section		57 A / 10 mm²	62 A / 6 AWG	Torque	1.3 Nm ± 0.3 11.5 lb.in ± 2.65
Rated short-time withstand current (1s)		1200 A			
Short Circuit Current Rating (with specific conditions)					
Rated voltage		630 V	300 V		
Impulse withstand voltage		8000 V			
Protection		IP20	NEMA 1		

The connecting capacity data for one Rigid: Solid/Stranded, or one Flexible conductor (when applicable) is a mandatory information required by IEC, UL and CSA standards (Copper conductors). All other data are provided as supplementary information only. For more details, please consult our CB, UL or CSA certificates and technical datasheet available on <http://www.TE.com>

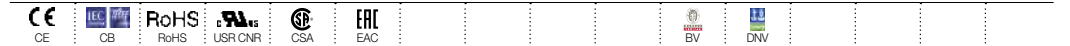

Accessories

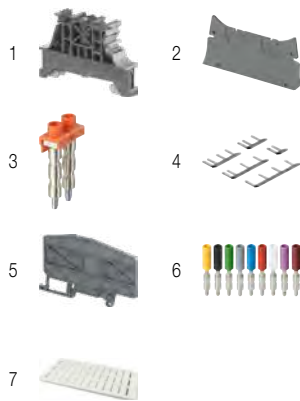

Description	Color	Type	Part Number	Pkg qty	Weight (1 pce) g	
1 End stops 10 mm 0.394 in	Dark grey <input type="checkbox"/>	BAM4	1SNK900001R0000	50	14.00	
2 End sections 2 mm 0.079 in	Dark grey <input type="checkbox"/>	ES10-ST	1SNK508910R0000	20	3.5	
3 Jumper bars	Orange <input type="checkbox"/>	2 poles 50 A (IEC)	JB8-2-R1	1SNK908902R0000	10	7.6
		3 poles 50 A (IEC)	JB8-3-R1	1SNK908903R0000	10	11.6
		4 poles 50 A (IEC)	JB8-4-R1	1SNK908904R0000	10	15.5
		5 poles 50 A (IEC)	JB8-5-R1	1SNK908905R0000	10	19.4
		10 poles 50 A (IEC)	JB8-10-R1	1SNK908910R0000	10	39.00
4 Lateral jumper bars	Black <input type="checkbox"/>	4/7 poles	PC8-R5	1SNA400842R0000	10	6.60
		2/3 poles	PC8-R6	1SNA400843R0000	10	6.60
		4/6 poles	PC8-R7	1SNA400849R0000	10	6.60
		4/8 poles	PC8-R8	1SNA400850R0000	10	7.80
5 Circuit separators 3 mm 0.118 in	Dark grey <input type="checkbox"/>	CS-R3	1SNK900107R0000	20	6.40	
6 Test sockets Test sockets DIA 4 mm 0.157 in	Yellow <input type="checkbox"/>	AJS9	1SNA179726R0200	25	3.60	
7 Terminal block markers	White <input type="checkbox"/>	Blank marker	MG-CPM 13 41791	1SNB041791R0612	1680	0.27
		Blank card	MC812	1SNK160000R0000	22	10.00
		Blank card	MC812PA	1SNK169999R0000	20	14.00
Universal wire markers holder	Grey <input type="checkbox"/>	UMH	1SNK900611R0000	10	0.20	

Complete list of accessories is indicated in the terminal block datasheet including end stops. Some accessories such as jumper bars may modify the terminal block's ratings: Complete information available in the accessories section of the catalog.

Technical data valid for copper conductors only.

ZS10-PE-R1 screw clamp terminal blocks

Ground - 8 mm 0.315 in spacing



ZS10-PE-R1

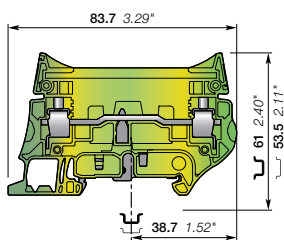

8 mm 0.315 in spacing

Description

- With the same profile as the ZS10-ST..., the ground ZS10-PE-R1 allows you to fully implement the electrical drawing of your CT or PT circuits,
- Fully compatible with the ZS10-ST... accessories,
- Short-circuit performances above the requirements of IEC 60947-7-2 terminal block standard,
- Secured snap on or remove from the rail.

Ordering details

Description	Color	Type	Part Number	Pkg qty	Weight (1 pce) g
Ground Profile aligned with ZS10-ST...	Green-yellow	ZS10-PE-R1	1SNK508151R0000	25	28.40

Main technical data

Connecting capacity	IEC	UL - CSA
1 conductor per clamp	Rigid: Solid/Stranded	24 ... 6 AWG
	Flexible without ferrule	24 ... 6 AWG
	Flexible with non insulated ferrule	24 ... 8 AWG
	Flexible with insulated ferrule	24 ... 10 AWG
	Gauge	A5-B5
Rated cross section	10 mm ²	6 AWG
Rated short-time withstand current (1s)	1200 A	1596 A
Protection	IP20	NEMA 1

Mounting instructions

Rail		TH 35-7.5, TH 35-15
Wire stripping length		13 mm 0.512 in
Tool		Flat screwdriver Ø 3.5 mm Ø 0.138 in
Torque		1.3 Nm ± 0.3 11.5 lb.in ± 2.65

The connecting capacity data for one Rigid: Solid/Stranded, or one Flexible conductor (when applicable) is a mandatory information required by IEC, UL and CSA standards (Copper conductors). All other data are provided as supplementary information only. For more details, please consult our CB, UL or CSA certificates and technical datasheet available on <http://www.TE.com>

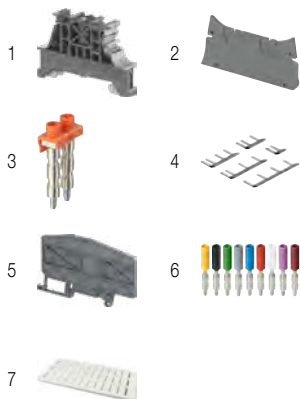
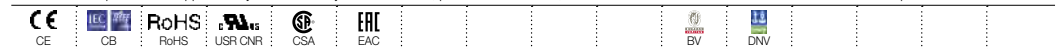

Accessories

Description	Color	Type	Part Number	Pkg qty	Weight (1 pce) g	
1 End stops 10 mm 0.394 in	Dark grey	BAM4	1SNK900001R0000	50	14.00	
2 End sections 2 mm 0.079 in	Dark grey	ES10-ST	1SNK508910R0000	20	3.5	
3 Jumper bars	Orange	2 poles 50 A (IEC)	JB8-2-R1	1SNK908902R0000	10	7.6
		3 poles 50 A (IEC)	JB8-3-R1	1SNK908903R0000	10	11.6
		4 poles 50 A (IEC)	JB8-4-R1	1SNK908904R0000	10	15.5
		5 poles 50 A (IEC)	JB8-5-R1	1SNK908905R0000	10	19.4
		10 poles 50 A (IEC)	JB8-10-R1	1SNK908910R0000	10	39.00
4 Lateral jumper bars	Black	4/7 poles	PC8-R5	1SNA400842R0000	10	6.60
		2/3 poles	PC8-R6	1SNA400843R0000	10	6.60
		4/6 poles	PC8-R7	1SNA400849R0000	10	6.60
		4/8 poles	PC8-R8	1SNA400850R0000	10	7.80
5 Circuit separators 3 mm 0.118 in	Dark grey	CS-R3	1SNK900107R0000	20	6.40	
6 Test sockets Test sockets DIA 4 mm 0.157 in	Yellow	AJS9	1SNA179726R0200	25	3.60	
7 Terminal block markers	White	Blank marker	MG-CPM 13 41791	1SNB041791R0612	1680	0.27
		Blank card	MC812	1SNK160000R0000	22	10.00
		Universal wire markers holder	MC812PA	1SNK169999R0000	20	14.00
	Grey	UMH	1SNK900611R0000	10	0.20	

Complete list of accessories is indicated in the terminal block datasheet including end stops. Some accessories such as jumper bars may modify the terminal block's ratings: Complete information available in the accessories section of the catalog.

Technical data valid for copper conductors only.



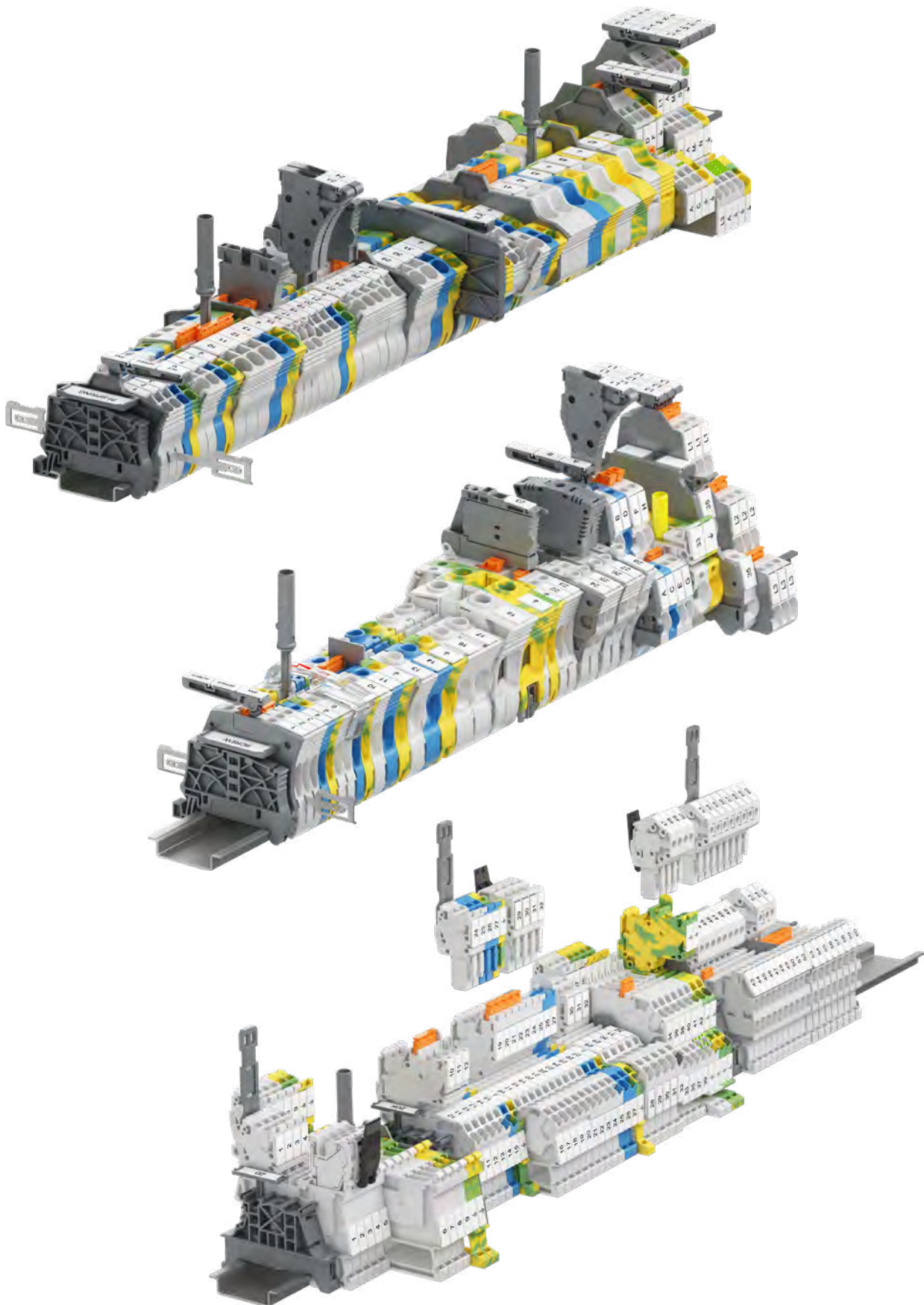

Railway applications, terminal blocks

Accessories

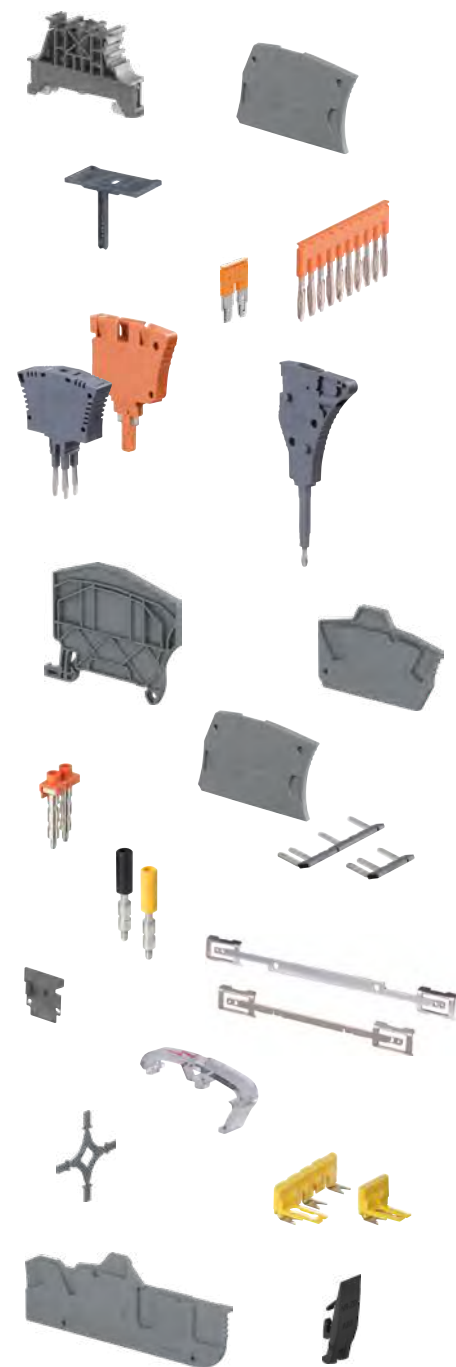

Common terminal block accessories

Mounting rail	PR	310-313
---------------	----	---------

SNK series, common terminal block accessories

Screw end stops	BAM4, BAZH1	314
Screwless end stops	BAZ1	315
Label holders	LH, LH-R1	316
	LH-J	317
Screwless jumper bars	JB5	318
	JB6	319
	JB8	320
	JB10	321
	JB12	322
Cross spacing jumpers	JB85-3	323
Test adapters	TP2, TP4	324
Test connectors	TC5	325
Component plugs	PG5-R2	326
	PG5, PG5-R1	327
Screwdrivers	TO	328
Crimping tools	PS	328

PI-Spring terminal block accessories

End sections	EK	329-331
Circuit separators	CS-R2, CS-R3	332-333
Shield connectors	SHBP, SHB	334

Screw clamp terminal block accessories

End sections	ES	335-336
Screw jumper bars	JB8	337
	JB16, JB22	338
	JB26	339
	BJMI31, BJMI36	340
Lateral jumper bars	PC8, PC81	341
Circuit separator	CS, CS-R1	342
Shield connectors	SHBS, SHB	343
Protecting covers	PL	344
	CO, KCO	345
Short circuit bridges	SC-JB8	346
Test sockets	AJS9	347

Pluggable terminal block accessories

End sections	EDK, EDS	348-349
Coding pegs	COP	350
Locking devices	VR	350

PR mounting rail

Common terminal block accessories



1SNK160017S0201

PR30

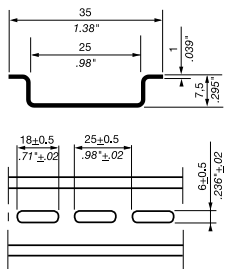

2000 mm 78.74 in spacing

Description

- Pre-punched symmetrical mounting rail,
- The slotted holes ease the mounting and allow to use existing and/or numerous fixings,
- Particularly well designed for fixing onto back-plates and for terminal assemblies of small dimensions.

Ordering details

Description	Color	Type	Part Number	Pkg meter	Weight (1 pce)
Prepunched rail		PR30	1SNA173220R0500	2	328.00

Please note that for all rails: 1 part number equal 1 meter (39 in). Packing of 2 meters (78 in) minimum. Check that your order quantity is a multiple of 2.

Main technical data

Material	Zinc plating and passivation steel				
Rail	TH 35-7.5				
	IEC	UL - CSA			
Equivalent E-Cu cross section	All the main technical data provided are "manufacturer" values.				
RoHS	RoHS				

Mounting instructions

- In order to guarantee the performances and security of your installation, please ensure the rail and its fixings can withstand the static and dynamic loads of the components mounted on it;
- To prevent the rail from flexing (1 mm 0.039 in rail thickness only), fixing is recommended every 250 mm 9.84 in;
- To prevent any issues during mounting, screw heads used for rail fixing should not protrude from the rail (7,5 mm 0.295 in rail height only).

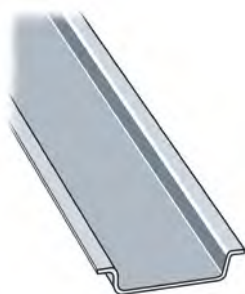

1SNK160017S0201

PR3.Z2

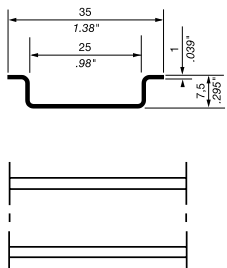

2000 mm 78.74 in spacing

Description

- Symmetrical mounting rail complying with IEC60715,
- Particularly well designed for fixing onto back-plates and for terminal assemblies of small dimensions.

Ordering details

Description	Color	Type	Part Number	Pkg meter	Weight (1 pce)
		PR3.Z2	1SNA174300R1700	2	718.00

Please note that for all rails: 1 part number equal 1 meter (39 in). Packing of 2 meters (78 in) minimum. Check that your order quantity is a multiple of 2.

Main technical data

Material	Zinc plating and passivation steel				
Rail	TH 35-7.5				
	IEC	UL - CSA			
Equivalent E-Cu cross section	16 mm ²				
	All the main technical data provided are "manufacturer" values.				
RoHS	RoHS				

Mounting instructions

- In order to guarantee the performances and security of your installation, please ensure the rail and its fixings can withstand the static and dynamic loads of the components mounted on it;
- To prevent the rail from flexing (1 mm 0.039 in rail thickness only), fixing is recommended every 250 mm 9.84 in;
- To prevent any issues during mounting, screw heads used for rail fixing should not protrude from the rail (7,5 mm 0.295 in rail height only).

Technical data valid for copper conductors only.

PR mounting rail

Common terminal block accessories



1SNA600073F0000

PR3.G2

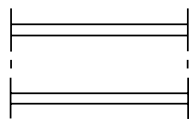
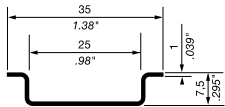

2000 mm 78.74 in spacing

Description

- Symmetrical mounting rail made of galvanised steel, complying with IEC60715,
- Particularly well designed for fixing onto back-plates and for terminal assemblies of small dimensions.

Ordering details

Description	Color	Type	Part Number	Pkg meter	Weight (1 pce) g
		PR3.G2	1SNA164800R0300	2	718.00

Please note that for all rails: 1 part number equal 1 meter (39 in). Packing of 2 meters (78 in) minimum. Check that your order quantity is a multiple of 2.

Main technical data

Material	Galvanised steel		
Rail	TH 35-7.5		
	IEC	UL - CSA	
Equivalent E-Cu cross section	16 mm ²		

All the main technical data provided are "manufacturer" values.

RoHS																			
RoHS																			

Mounting instructions

- In order to guarantee the performances and security of your installation, please ensure the rail and its fixings can withstand the static and dynamic loads of the components mounted on it;
- To prevent the rail from flexing (1 mm 0.039 in rail thickness only), fixing is recommended every 250 mm 9.84 in;
- To prevent any issues during mounting, screw heads used for rail fixing should not protrude from the rail (7,5 mm 0.295 in rail height only).



1SNA600074F0000

PR50

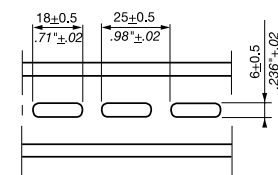
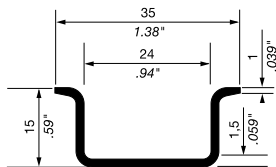

2000 mm 78.74 in spacing

Description

- Pre-punched symmetrical mounting rail,
- The slotted holes ease the mounting and allow to use existing and/or numerous fixings.

Ordering details

Description	Color	Type	Part Number	Pkg meter	Weight (1 pce) g
Prepunched rail		PR50	1SNA178529R0400	2	1288.00

Please note that for all rails: 1 part number equal 1 meter (39 in). Packing of 2 meters (78 in) minimum. Check that your order quantity is a multiple of 2.

Main technical data

Material	Zinc plating and passivation steel		
Rail	TH 35-15		
	IEC	UL - CSA	
Equivalent E-Cu cross section			

All the main technical data provided are "manufacturer" values.

RoHS																			
RoHS																			

Mounting instructions

- In order to guarantee the performances and security of your installation, please ensure the rail and its fixings can withstand the static and dynamic loads of the components mounted on it;
- To prevent the rail from flexing, fixing is recommended every 700 mm 27.6 in;
- In order to increase the accessibility of your terminal assembly, we recommend the use of our rail offset brackets EM45 (order code 1SNA008521R2600) for a 45° orientation of the rail.

Technical data valid for copper conductors only.

PR mounting rail

Common terminal block accessories

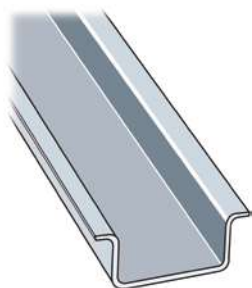

1SNA00075F0000

PR5

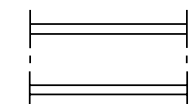
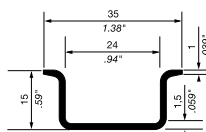

2000 mm 78.74 in spacing

Description

- Symmetrical mounting rail.

Ordering details

Description	Color	Type	Part Number	Pkg meter	Weight (1 pce) g
		PR5	1SNA168700R2200	2	1200.00

Please note that for all rails: 1 part number equal 1 meter (39 in). Packing of 2 meters (78 in) minimum. Check that your order quantity is a multiple of 2.

Main technical data

Material	Zinc plating and passivation steel
Rail	TH 35-15

	IEC	UL - CSA
--	-----	----------

Equivalent E-Cu cross section

All the main technical data provided are "manufacturer" values.

RoHS									
RoHS									

Mounting instructions

- In order to guarantee the performances and security of your installation, please ensure the rail and its fixings can withstand the static and dynamic loads of the components mounted on it;
- To prevent the rail from flexing, fixing is recommended every 700 mm 27.6 in;
- In order to increase the accessibility of your terminal assembly, we recommend the use of our rail offset brackets EM45 (order code 1SNA008521R2600) for a 45° orientation of the rail.



1SNA00076F0000

PR4

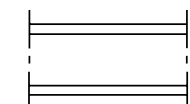
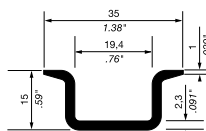

2000 mm 78.74 in spacing

Description

- Symmetrical mounting rail complying with IEC60715,
- The rigidity of the rail is maximised by the 2.3 mm 0.090 in thickness of the rail, and by its solid, non slotted construction,
- PR4 TH 35-15 is the most rigid mounting rail solution and it can support

Ordering details

Description	Color	Type	Part Number	Pkg meter	Weight (1 pce) g
Recommended for SNK ground terminal blocks up to 35 mm² 2 AWG		PR4	1SNA168500R1200	2	915.00

Please note that for all rails: 1 part number equal 1 meter (39 in). Packing of 2 meters (78 in) minimum. Check that your order quantity is a multiple of 2.

Main technical data

Material	Zinc plating and passivation steel
Rail	TH 35-15

	IEC	UL - CSA
--	-----	----------

Equivalent E-Cu cross section

All the main technical data provided are "manufacturer" values.

RoHS									
RoHS									

Mounting instructions

- In order to guarantee the performances and security of your installation, please ensure the rail and its fixings can withstand the static and dynamic loads of the components mounted on it;
- To prevent the rail from flexing, fixing is recommended every 700 mm 27.6 in;
- In order to increase the accessibility of your terminal assembly, we recommend the use of our rail offset brackets EM45 (order code 1SNA008521R2600) for a 45° orientation of the rail.

Technical data valid for copper conductors only.

1SNA160041S0201

PR mounting rail

Common terminal block accessories



1SNC16041FR014

PRH2R

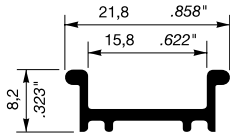

2000 mm 78.74 in spacing

Description

- Symmetrical mounting rail type 2 reinforced,
- Particularly well adapted for railway applications.

Ordering details

Description	Color	Type	Part Numbers	Pkg pce	Weight (1 pce) g
		PRH2R	1SNA163350R1500	2	278.00

Please note that for all rails: 1 part number equal 1 meter (39 in). Packing of 2 meters (78 in) minimum.
Check that your order quantity is a multiple of 2.

Main technical data

Material	Aluminium alloy
Rail	Type 2

	IEC	UL - CSA
--	-----	----------

Equivalent E-Cu cross section

All the main technical data provided are "manufacturer" values.

	RoHS RoHS									
--	--------------	--	--	--	--	--	--	--	--	--

Mounting instructions

- In order to guarantee the performances and security of your installation, please ensure the rail and its fixings can withstand the static and dynamic loads of the components mounted on it,
- To prevent the rail from flexing, fixing is recommended every 250 mm 9.84 in,
- To prevent any issues during mounting, screw heads used for rail fixing should not protrude from the rail.

Screw end stops

Common terminal block accessories



1SNK16033V0014

BAM4

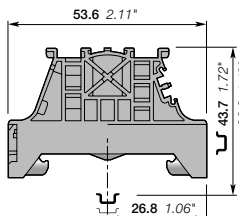

10 mm 0.394 in spacing

Mounting instructions



BAM4 screw end stops

Description

- Give efficient support to the SNK terminal blocks assemblies thanks to the BAM4 double gripping rail contact,
- Ease the assemblies identification with the BAM4 marking location compatible with all SNK markers and labels.

Ordering details

Description	Color	Type	Part Number	Pkg qty	Weight (1 pce) g
10 mm 0.394 in spacing	Dark grey <input checked="" type="checkbox"/>	BAM4	1SNK900001R0000	50	14.00

Main technical data

Material specifications	Insulating material	Polyamide	
	Flammability	V0	
Ambient temperature min/max	NF F 16 101	I2F2	
	Service IEC 60068-2-1	-55 ... +110 °C	-67 ... +230 °F
	Storage	-55 ... +110 °C	-67 ... +230 °F
	Installing	-5 ... +40 °C	+23 ... +104 °F

Mounting instructions

Rail		TH 35-7.5, TH 35-15
Tool		Flat screwdriver Ø 5.5 mm Ø 0.217 in
Torque		0.9 Nm ± 0.1 7.08 lb.in ± 0.88

All the main technical data provided are "manufacturer" values

RoHS
RoHS

Accessories

Description	Color	Type	Part Number	Pkg qty	Weight (1 pce) g
Terminal block markers compatible with MG3	White <input type="checkbox"/>	MG-CPM 13 41791	1SNB041791R0612	1680	0.27
Blank card	In polycarbonate	MC812	1SNK160000R0000	22	10.00
		MC812PA	1SNK169999R0000	20	14.00
Label holder	Dark grey <input checked="" type="checkbox"/>	LH	1SNK900605R0000	50	0.60
		LH-R1	1SNK900607R0000	50	1.10
Universal wire markers holder	Grey <input type="checkbox"/>	UMH	1SNK900611R0000	10	0.20

BAZH1 screw end stops

Description

- Give efficient support to the SNK double deck or power terminal blocks assemblies thanks to the BAZH1 double gripping rail contact,
- Ease the assemblies identification with label holders.

Ordering details

Description	Color	Type	Part Number	Pkg qty	Weight (1 pce) g
10 mm 0.394 in spacing	Dark grey <input checked="" type="checkbox"/>	BAZH1	1SNK900102R0000	20	24.00

Main technical data

Material specifications	Insulating material	Polyamide	
	Flammability	V0	
Ambient temperature min/max	NF F 16 101	I2F2	
	Service IEC 60068-2-1	-55 ... +110 °C	-67 ... +230 °F
	Storage	-55 ... +110 °C	-67 ... +230 °F
	Installing	-5 ... +40 °C	+23 ... +104 °F

Mounting instructions

Rail		TH 35-7.5
Tool		Flat screwdriver Ø 5.5 mm Ø 0.217 in
Torque		1.3 Nm ± 0.1 11.4 lb.in ± 0.88

All the main technical data provided are "manufacturer" values

RoHS
RoHS

Accessories

Description	Color	Type	Part Number	Pkg qty	Weight (1 pce) g
Terminal block markers compatible with MG3	White <input type="checkbox"/>	MG-CPM 13 41791	1SNB041791R0612	1680	0.27
Blank card	In polycarbonate	MC812	1SNK160000R0000	22	10.00
		MC812PA	1SNK169999R0000	20	14.00
Label holder	Dark grey <input checked="" type="checkbox"/>	LH	1SNK900605R0000	50	0.60
		LH-R1	1SNK900607R0000	50	1.10
Universal wire markers holder	Grey <input type="checkbox"/>	UMH	1SNK900611R0000	10	0.20

Technical data valid for copper conductors only.



1SNK16009AF0014

BAZH1

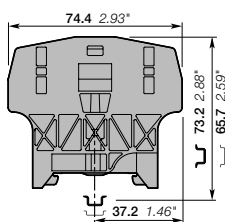

10 mm 0.394 in spacing

Screwless end stops

Common terminal block accessories



BAZ1

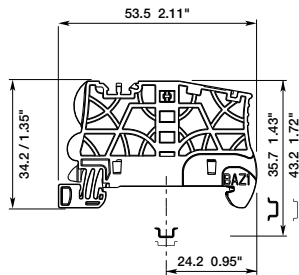

5.2 mm 0.205 in spacing

BAZ1 screwless end stops

Description

- Reduce the size of your terminal block assemblies with the screwless reduced spacing BAZ1 end stop,
- Ease the assemblies identification with various markers and label holders.

Ordering details

Description	Color	Type	Part Number	Pkg qty	Weight (1 pce) g
5.2 mm 0.205 in spacing	Dark grey <input checked="" type="checkbox"/>	BAZ1	1SNK900002R0000	50	5.30

Main technical data

Material specifications		Insulating material		Polyamide		Mounting instructions	
Flammability		NF F 16 101		V0		Rail	
Ambient temperature min/max		Service IEC 60068-2-1		-55 ... +110 °C		TH 35-7.5	
		Storage		-55 ... +110 °C			
		Installing		-5 ... +40 °C			
				-67 ... +230 °F			
				-67 ... +230 °F			
				+23 ... +104 °F			

All the main technical data provided are "manufacturer" values

RoHS	
<input checked="" type="checkbox"/>	RoHS

Accessories

Description	Color	Type	Part Number	Pkg qty	Weight (1 pce) g
Terminal block markers compatible with MG3	White <input type="checkbox"/>	MG-CPM 13 41790	1SNB041790R0512	1960	0.23
Blank card compatible with HTP500		MC512	1SNK140000R0000	22	9.00
Blank card compatible with AMS600		MC512PA	1SNK149999R0000	20	10.00
Label holder 10 mm 0.394 in width	Dark grey <input checked="" type="checkbox"/>	LH	1SNK900605R0000	50	0.60
Label holder 19.5 mm 0.768 in width		LH-R1	1SNK900607R0000	50	1.10
Universal wire markers holder 5.2 mm 0.205 in spacing	Grey <input type="checkbox"/>	UMH	1SNK900611R0000	10	0.20

Technical data valid for copper conductors only.

Label holder

Common terminal block accessories



1SNK1603340014

LH
10 mm 0.394 in spacing

LH label holder

Description

- Easily identify your terminal blocks assembly with white or yellow labels,
- Adjustable in height for best visibility,
- Compatible with all SNK end stops.

Ordering details

Description	Color	Type	Part Number	Pkg qty	Weight (1 pce) g
10 mm 0.394 in width	Dark grey <input checked="" type="checkbox"/>	LH	1SNK900605R0000	50	0.60

Main technical data

Material specifications	Insulating material	Polyamide			
	Flammability	V0			
	NF F 16 101	I2F2			
Ambient temperature min/max	Service IEC 60068-2-1	-55 ... +110 °C	-67 ... +230 °F		
	Storage	-55 ... +110 °C	-67 ... +230 °F		
	Installing	-5 ... +40 °C	+23 ... +104 °F		

All the main technical data provided are "manufacturer" values

RoHS
RoHS

Accessories

Description	Color	Type	Part Number	Pkg qty	Weight (1 pce) g
Self-adhesive precut blank label compatible with HTP500	White <input type="checkbox"/>	MCLH	1SNK900630R0000	25	10.00
Self-adhesive precut blank label compatible with HTP500	White <input type="checkbox"/>	RCPEAD-TT	1SNA235158R0100	25	9.80
	Yellow <input type="checkbox"/>	RCPEAD-TT-YL	1SNA235159R0200	25	12.10
Pre-printed cover marker Protection for RCPEAD markers	Transparent <input checked="" type="checkbox"/>	EPR2	1SNA399726R0700	10	4.00
Precut blank label compatible with MG3	White <input type="checkbox"/>	MG-TAR 45490	1SNB045490R8530	1650	0.371
Self-adhesive precut blank label compatible with MG3	Yellow <input type="checkbox"/>	MG-TAA 49448	1SNB049448R8530	825	0.55
	White <input type="checkbox"/>	MG-TAA 49498	1SNB049498R8530	825	0.55
Self-adhesive precut blank label compatible with HTP500	Yellow <input type="checkbox"/>	MCLH-YL	1SNK900633R0000	25	10.00



1SNK1603500014

LH
19.5 mm 0.768 in spacing

LH-R1 label holder

Description

- Easily identify your terminal blocks assembly with white or yellow labels,
- Adjustable in height for best visibility,
- Compatible with all SNK end stops.

Ordering details

Description	Color	Type	Part Number	Pkg qty	Weight (1 pce) g
19.5 mm 0.768 in width	Dark grey <input checked="" type="checkbox"/>	LH-R1	1SNK900607R0000	50	1.10

Main technical data

Material specifications	Insulating material	Polyamide			
	Flammability	V0			
	NF F 16 101	I2F2			
Ambient temperature min/max	Service IEC 60068-2-1	-55 ... +110 °C	-67 ... +230 °F		
	Storage	-55 ... +110 °C	-67 ... +230 °F		
	Installing	-5 ... +40 °C	+23 ... +104 °F		

All the main technical data provided are "manufacturer" values

RoHS
RoHS

Accessories

Description	Color	Type	Part Number	Pkg qty	Weight (1 pce) g
Self-adhesive precut blank label compatible with HTP500	White <input type="checkbox"/>	MCLH-R1	1SNK900631R0000	25	10.00
Precut blank label Protection for RCPEB markers	White <input type="checkbox"/>	RCPEB	1SNA178430R0500	1	
	Transparent <input checked="" type="checkbox"/>	EPR1	1SNA178431R2200	1	0.05
Self-adhesive precut blank label compatible with HTP500	White <input type="checkbox"/>	PIB2-TT	1SNA235155R2600	25	9.70
	Yellow <input type="checkbox"/>	PIB2-TT-YL	1SNA235157R2000	25	9.40
Precut blank label compatible with MG3	White <input type="checkbox"/>	MG-TAR 45194	1SNB045194R1735	900	0.62
Self-adhesive precut blank label	Yellow <input type="checkbox"/>	MG-TAA 49148	1SNB049148R1735	450	0.91
	White <input type="checkbox"/>	MG-TAA 49198	1SNB049198R1735	450	0.91
Self-adhesive precut blank label compatible with HTP500	Yellow <input type="checkbox"/>	MCLH-R1-YL	1SNK900634R0000	25	10.00

Technical data valid for copper conductors only.

Mounting instructions



Label holder

Common terminal block accessories



1SNK16096S0201

LH

4.8 mm 0.189 in spacing

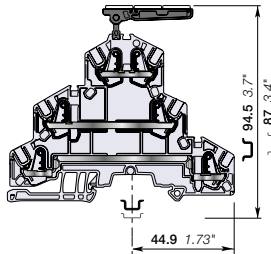

LH-J label holder

Description

Easily identify your block with three standard 5.2 mm 0.205 in spacing SNK markers. It fits in the jumper channel of the SNK terminal blocks.

Ordering details

Description	Color	Type	Part Number	Pkg qty	Weight (1 pce) g
Rotating label holder with three SNK markers housings - 4.8 mm 0.189 in spacing	Dark grey <input checked="" type="checkbox"/>	LH-J	1SNK900606R0000	100	0.73

Main technical data

Material specifications	Insulating material	Polyamide			
	Flammability	V0			
	NF F 16 101	I2F2			
Ambient temperature min/max	Service IEC 60068-2-1	-55 ... +110 °C	-67 ... +230 °F		
	Storage	-55 ... +110 °C	-67 ... +230 °F		
	Installing	-5 ... +40 °C	+23 ... +104 °F		

All the main technical data provided are "manufacturer" values

	RoHS				
	RoHS				

Accessories

Description	Color	Type	Part Number	Pkg qty	Weight (1 pce) g
Blank marker compatible with MG3	White <input type="checkbox"/>	MG-CPM 13 41790	1SNB041790R0512	1960	0.23
Blank card compatible with HTP500	White <input type="checkbox"/>	MC512	1SNK140000R0000	22	9.00
	White <input type="checkbox"/>	MC512PA	1SNK149999R0000	20	10.00
Universal wire markers holder 5.2 mm 0.205 in spacing	Grey <input type="checkbox"/>	UMH	1SNK900611R0000	10	0.20

Technical data valid for copper conductors only.

JB5 screwless jumper bars

Common terminal block accessories



1SNK160143P0014

JB5
5.2 mm 0.205 in spacing

Description

Facilitate & secure your jumper bar assembly process:

- Screwless mounting,
- Pre-cut poles for alternated jumpering between terminal blocks,
- Insulated,
- Positive locking,
- Perfectly adapted to low level electrical contact (20mA, 50mV).

Ordering details

Description		Color	Type	Part Number	Pkg qty	Weight (1 pce) g
5.2 mm 0.205 in spacing	2 poles	Orange	JB5-2	1SNK905302R0000	50	1.30
	3 poles		JB5-3	1SNK905303R0000	50	2.00
	4 poles		JB5-4	1SNK905304R0000	50	2.70
	5 poles		JB5-5	1SNK905305R0000	50	3.50
	10 poles		JB5-10	1SNK905310R0000	30	7.10
	50 poles		JB5-50	1SNK905350R0000	10	36.00

Main technical data

Material specifications	Insulating material	Polyamide		
	Flammability	V0		
	NF F 16 101	I2F3		
Ambient temperature min/max	Service IEC 60068-2-1	-55 ... +110 °C	-67 ... +230 °F	
	Storage	-55 ... +110 °C	-67 ... +230 °F	
	Installing	-5 ... +40 °C	+23 ... +104 °F	
		IEC	UL - CSA	Ex e
Rated current		32 A	30 A	
Rated voltage	1 - Standard use	1000 V	600 V	Please consult us
	2 - Cut extremities	800 V	300 V	
	3 - Cut poles	630 V	300 V	
	4 - Alternated poles	400 V	150 V	
	5 - Alternated poles with cut extremities	400 V	150 V	
Impulse withstand voltage		8000 V		
Protection		IP20	NEMA 1	
All the main technical data are indicative "manufacturer" values.				
	RoHS			
	RoHS			

Mounting instructions

1 - Standard use

2 - Cut extremities
For voltage rating > 50 V and Uimp > 2.5 KV, the below accessories must be installed on the cut side of the jumper to guarantee IP20 and voltage rating:

ZS...	Feed-through	CS circuit separator
ZK...	Double deck / triple deck	ES... end section
	All functions	EK... end section

Ensure a good straight cut by positioning the cutting tool on the vertical snicks of the insulated part of the jumper.

15 poles max. recommended for convenient mounting.

3 - Cut poles

4 - Alternated poles

5 - Alternated poles with cut extremities
When using cut jumpers, cut extremities should be placed oppositely to allow end sections / circuit separators placement at each cut extremities.

For all other applications, please consult us.

Technical data valid for copper conductors only.

1SNK160027S0201

JB6 screwless jumper bars

Common terminal block accessories



1SNK160143F0014

JB6
6 mm 0.236 in spacing

Description

Facilitate & secure your jumper bar assembly process:

- Screwless mounting,
- Pre-cut poles for alternated jumpering between terminal blocks,
- Insulated,
- Positive locking,
- Perfectly adapted to low level electrical contact (20mA, 50mV).

Ordering details

Description		Color	Type	Part Number	Pkg qty	Weight (1 pce) g
6 mm 0.236 in spacing	2 poles	Orange	JB6-2	1SNK906302R0000	50	1.30
	3 poles		JB6-3	1SNK906303R0000	50	2.10
	4 poles		JB6-4	1SNK906304R0000	50	2.90
	5 poles		JB6-5	1SNK906305R0000	50	3.60
	10 poles		JB6-10	1SNK906310R0000	20	7.40
	50 poles		JB6-50	1SNK906350R0000	10	38.10

Main technical data

Material specifications	Insulating material	Polyamide		
	Flammability	V0		
	NF F 16 101	I2F3		
Ambient temperature min/max	Service IEC 60068-2-1	-55 ... +110 °C	-67 ... +230 °F	
	Storage	-55 ... +110 °C	-67 ... +230 °F	
	Installing	-5 ... +40 °C	+23 ... +104 °F	
		IEC	UL - CSA	Ex e
Rated current		41 A	30 A	
Rated voltage	1 - Standard use	1000 V	600 V	Please consult our dedicated certificates
	2 - Cut extremities	800 V	300 V	
	3 - Cut poles	630 V	300 V	
	4 - Alternated poles	400 V	150 V	
	5 - Alternated poles with cut extremities	400 V	150 V	
Impulse withstand voltage		8000 V		
Protection		IP20	NEMA 1	
All the main technical data are indicative "manufacturer" values.				
	RoHS			
	RoHS			

Mounting instructions

1 - Standard use

2 - Cut extremities
For voltage rating > 50 V and Uimp > 2.5 KV, the below accessories must be installed on the cut side of the jumper to guarantee IP20 and voltage rating:

ZS...	Feed-through	CS circuit separator
ZK...	Double deck / triple deck	ES... end section
	All functions	EK... end section

Ensure a good straight cut by positioning the cutting tool on the vertical snicks of the insulated part of the jumper.

15 poles max. recommended for convenient mounting.

3 - Cut poles

4 - Alternated poles

5 - Alternated poles with cut extremities
When using cut jumpers, cut extremities should be placed oppositely to allow end sections / circuit separators placement at each cut extremities.

For all other applications, please consult us.

Technical data valid for copper conductors only.

1SNK160029S0201

JB8 screwless jumper bars

Common terminal block accessories



1SNK160146F0014

JB8
8 mm 0.315 in spacing

Description

Facilitate & secure your jumper bar assembly process:

- Screwless mounting,
- Pre-cut poles for alternated jumpering between terminal blocks,
- Insulated,
- Positive locking,
- Perfectly adapted to low level electrical contact (20mA, 50mV).

Ordering details

Description	Color	Type	Part Number	Pkg qty	Weight (1 pce)
8 mm 0.315 in spacing	Orange	JB8-2	1SNK908302R0000	50	2.70
		JB8-3	1SNK908303R0000	50	4.10
		JB8-4	1SNK908304R0000	50	5.60
		JB8-5	1SNK908305R0000	40	7.00
		JB8-10	1SNK908310R0000	20	14.20

Main technical data

Material specifications	Insulating material	Polyamide		
	Flammability	V0		
	NF F 16 101	I2F3		
Ambient temperature min/max	Service IEC 60068-2-1	-55 ... +110 °C	-67 ... +230 °F	
	Storage	-55 ... +110 °C	-67 ... +230 °F	
	Installing	-5 ... +40 °C	+23 ... +104 °F	
Rated current		IEC	UL - CSA	Ex e
		57 A	42 A	
Rated voltage	1 - Standard use	1000 V	600 V	693 V
	2 - Cut extremities	800 V	300 V	440 V
	3 - Cut poles	630 V	300 V	440 V
	4 - Alternated poles	630 V	150 V	352 V
	5 - Alternated poles with cut extremities	630 V	150 V	352 V
Impulse withstand voltage		6000 V		
Protection		IP20	NEMA 1	
All the main technical data are indicative "manufacturer" values.				
	RoHS			
	RoHS			

Mounting instructions

1 - Standard use

2 - Cut extremities
For voltage rating > 50 V and Uimp > 2.5 KV, the below accessories must be installed on the cut side of the jumper to guarantee IP20 and voltage rating:

ZS...	Feed-through	CS circuit separator
	Double deck / triple deck	ES... end section
ZK...	All functions	EK... end section

Ensure a good straight cut by positioning the cutting tool on the vertical snicks of the insulated part of the jumper.

3 - Cut poles

4 - Alternated poles

5 - Alternated poles with cut extremities
When using cut jumpers, cut extremities should be placed oppositely to allow end sections / circuit separators placement at each cut extremities.

For all other applications, please consult us.

Technical data valid for copper conductors only.

JB10 screwless jumper bars

Common terminal block accessories



1SNK160146P0014

JB10
10 mm 0.394 in spacing

Description

Facilitate & secure your jumper bar assembly process:

- Screwless mounting,
- Pre-cut poles for alternated jumpering between terminal blocks,
- Insulated,
- Positive locking,
- Perfectly adapted to low level electrical contact (20mA, 50mV).

Ordering details

Description	Color	Type	Part Number	Pkg qty	Weight (1 pce)
10 mm 0.394 in spacing	Orange	2 poles	JB10-2	50	4.60
		3 poles	JB10-3	50	7.10
		4 poles	JB10-4	40	9.40
		5 poles	JB10-5	30	12.00
		10 poles	JB10-10	20	24.00

Main technical data

Material specifications	Insulating material	Polyamide		
	Flammability	V0		
	NF F 16 101	I2F3		
Ambient temperature min/max	Service IEC 60068-2-1	-55 ... +110 °C	-67 ... +230 °F	
	Storage	-55 ... +110 °C	-67 ... +230 °F	
	Installing	-5 ... +40 °C	+23 ... +104 °F	
		IEC	UL - CSA	Ex e
Rated current		76 A	67 A	
Rated voltage	1 - Standard use	1000 V	600 V	693 V
	2 - Cut extremities	800 V	300 V	440 V
	3 - Cut poles	630 V	300 V	440 V
	4 - Alternated poles	400 V	150 V	275 V
	5 - Alternated poles with cut extremities	250 V	150 V	176 V
Impulse withstand voltage		6000 V		
Protection		IP20	NEMA 1	
All the main technical data are indicative "manufacturer" values.				
	RoHS			
	RoHS			

Mounting instructions

1 - Standard use

2 - Cut extremities

For voltage rating > 50 V and Uimp > 2.5 KV, the below accessories must be installed on the cut side of the jumper to guarantee IP20 and voltage rating:

ZS...	Feed-through	CS circuit separator
	Double deck / triple deck	ES... end section
ZK...	All functions	EK... end section

3 - Cut poles

4 - Alternated poles

5 - Alternated poles with cut extremities

When using cut jumpers, cut extremities should be placed oppositely to allow end sections / circuit separators placement at each cut extremities.

For all other applications, please consult us.

9

Technical data valid for copper conductors only.

JB12 screwless jumper bars

Common terminal block accessories



1SNK160230V0014

JB12
12 mm 0.472 in spacing

Description

Facilitate & secure your jumper bar assembly process:

- Screwless mounting,
- Pre-cut poles for alternated jumpering between terminal blocks,
- Insulated,
- Positive locking,
- Perfectly adapted to low level electrical contact (20mA, 50mV).

Ordering details

Description		Color	Type	Part Number	Pkg qty	Weight (1 pce)
12 mm 0.472 in spacing	2 poles	Orange	JB12-2	1SNK912302R0000	50	4.90
	3 poles		JB12-3	1SNK912303R0000	50	7.60
	5 poles		JB12-5	1SNK912305R0000	20	12.90

Main technical data

Material specifications	Insulating material	Polyamide		
	Flammability	V0		
Ambient temperature min/max	NF F 16 101	I2F2		
	Service IEC 60068-2-1	-55 ... +110 °C	-67 ... +230 °F	
	Storage	-55 ... +110 °C	-67 ... +230 °F	
	Installing	-5 ... +40 °C	+23 ... +104 °F	
Rated current		IEC	UL - CSA	Ex e
		76 A	67 A	
Rated voltage	1 - Standard use	1000 V	600 V	693 V
	2 - Cut extremities	800 V	300 V	440 V
	3 - Cut poles	630 V	300 V	440 V
	4 - Alternated poles	320 V	150 V	220 V
	5 - Alternated poles with cut extremities	250 V	150 V	176 V
Impulse withstand voltage		6000 V		
Protection		IP20	NEMA 1	
All the main technical data are indicative "manufacturer" values.				
	RoHS			
	RoHS			

Mounting instructions

①

1 - Standard use

②

2 - Cut extremities

For voltage rating > 50 V and Uimp > 2.5 KV, the below accessories must be installed on the cut side of the jumper to guarantee IP20 and voltage rating:

ZS...	Feed-through	CS circuit separator
	Double deck / triple deck	ES... end section
ZK...	All functions	EK... end section

③

3 - Cut poles

④

4 - Alternated poles

⑤

5 - Alternated poles with cut extremities

When using cut jumpers, cut extremities should be placed oppositely to allow end sections / circuit separators placement at each cut extremities.

For all other applications, please consult us.

Technical data valid for copper conductors only.

1SNK160071S0201

JB85-3 cross spacing jumpers

Common terminal block accessories



1SNK160125FP0014

JB85
8 mm 0.315 in spacing

Description

- Allows power distribution between terminal blocks with different spacing,
- JB5-3, JB6-3 and JB8-3 can be used as cross spacing jumpers (see selection table on mounting instructions below).

Ordering details

Description	Color	Type	Part Number	Pkg qty	Weight (1 pce)
Cross spacing jumpers 3 poles	Orange	JB85-3	1SNK900603R0000	10	2.80 g

Main technical data

Material specifications	Insulating material	Polyamide			
	Flammability	V0			
	NF F 16 101	I2F3			
Ambient temperature min/max	Service IEC 60068-2-1	-55 ... +110 °C	-67 ... +230 °F		
	Storage	-55 ... +110 °C	-67 ... +230 °F		
	Installing	-5 ... +40 °C	+23 ... +104 °F		

	IEC	UL - CSA	Ex e
Rated current	32 A	30 A	
Rated voltage	Standard use	1000 V	600 V
	Cut extremities	800 V	300 V
	Cut poles	630 V	300 V
Impulse withstand voltage	8000 V		
Protection	IP20	NEMA 1	

All the main technical data provided are "manufacturer" values

	RoHS								
	RoHS								

Mounting instructions

Cross spacing jumper selection between A and B terminal blocks with different spacing.

	B: 5.2 mm	6 mm	8 mm
A			
6 mm	JB5.3	-	-
8 mm	JB85.3	JB85.3	-
10 mm	JB85.3	JB85.3	JB8.3
12 mm	JB85.3	JB6.3	-

Yellow cell: for ZS and ZK terminal blocks

Blue cell: for ZS terminal blocks only

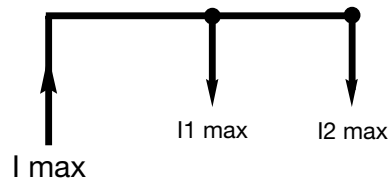

$$I1 \text{ max} + I2 \text{ max} \leq I \text{ max}$$

$$I1 \text{ max} \leq I \text{ rated terminal block}$$

$$I2 \text{ max} \leq I \text{ rated terminal block}$$

Technical data valid for copper conductors only.

Test adapters

Common terminal block accessories



TP

7.6 mm 0.299 in spacing

Mounting instructions

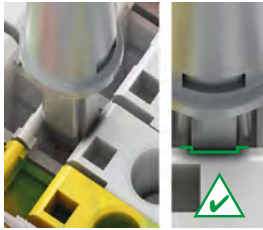

TP2 test adapters

Description

- Insulated test adapter that enables individual voltage control,
- Direct plug-in solution into the jumpers channels,
- Compatible with standard isolated or non isolated test plugs DIA 2 mm 0.079 in and 2.3 mm 0.090 in,
- Withstand more than 10000 operations according to TE Connectivity test standards.

Ordering details

Description	Color	Type	Part Number	Pkg qty	Weight (1 pce) g
For test plugs DIA 2 mm 0.079 in	Dark grey	TP2	1SNK900203R0000	20	1.70

Main technical data

Material specifications	Insulating material	Polyamide			
	Flammability	V0			
	NF F 16 101	I2F2			
Ambient temperature min/max	Service IEC 60068-2-1	-55 ... +110 °C	-67 ... +230 °F		
	Storage	-55 ... +110 °C	-67 ... +230 °F		
	Installing	-5 ... +40 °C	+23 ... +104 °F		
		IEC	UL - CSA	Ex e	
Rated current		10 A			
Rated voltage	Standard use	1000 V	600 V	Not authorized	
Impulse withstand voltage		8000 V			
Protection		IP20	NEMA 1		
All the main technical data provided are "manufacturer" values					
	RoHS				
	RoHS				



TP

7.6 mm 0.299 in spacing

Mounting instructions

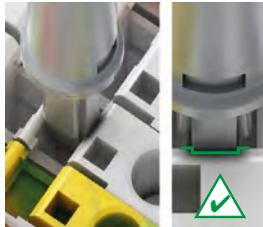

TP4 test adapters

Description

- Isolated test adapter that enables individual voltage control,
- Direct plug-in solution into the jumpers channels,
- Compatible with standard insulated or non isolated test plugs DIA 4 mm 0.157 in,
- Withstand more than 10000 operations according to TE Connectivity test standards.

Ordering details

Description	Color	Type	Part Number	Pkg qty	Weight (1 pce) g
For test plugs DIA 4 mm 0.157 in	Dark grey	TP4	1SNK900205R0000	20	2.40

Main technical data

Material specifications	Insulating material	Polyamide			
	Flammability	V0			
	NF F 16 101	I2F2			
Ambient temperature min/max	Service IEC 60068-2-1	-55 ... +110 °C	-67 ... +230 °F		
	Storage	-55 ... +110 °C	-67 ... +230 °F		
	Installing	-5 ... +40 °C	+23 ... +104 °F		
		IEC	UL - CSA	Ex e	
Rated current		16 A			
Rated voltage	Standard use	1000 V	600 V	Not authorized	
Impulse withstand voltage		8000 V			
Protection		IP20	NEMA 1		
All the main technical data provided are "manufacturer" values					
	RoHS				
	RoHS				

Technical data valid for copper conductors only.

TC5 test connectors

Common terminal block accessories



5.2 mm 0.205 in spacing

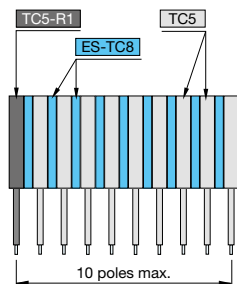
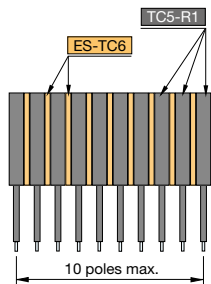
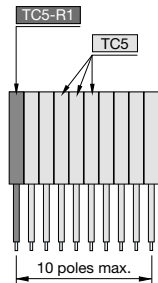

PT-3

Description

Ease the testing of terminal block assemblies:

- Make your own test connector assembly with our modular solution mixing various spacings,
- Direct plug-in solution into the jumpers channels,
- Withstand more than 10000 operations according to TE Connectivity test standards.

Main technical data

Connecting capacity		IEC	UL - CSA	Mounting instructions	
1 conductor per clamp	Rigid - Solid / Stranded	0.2 ... 1.5 mm ²		Rail	Wire stripping length 8 mm 0.314 in
	Flexible without ferrule	0.22 ... 1.5 mm ²			
	Flexible with non insulated ferrule			Tool	Flat screwdriver Ø 2.5 mm Ø 0.098 in
	Flexible with insulated ferrule	0.22 ... 1.5 mm ²			
Gauge		A1-B1		Torque	0.5 Nm ± 0.1 3.43 lb.in ± 0.885
2 conductors per clamp	Rigid - Solid / Stranded	0.2 ... 0.75 mm ²			
		Flexible without ferrule	0.22 ... 0.75 mm ²		
		Flexible with twin ferrule	0.22 ... 0.75 mm ²		
Rated current / Rated cross section		16 A / 1.5 mm ²			
Rated short-time withstand current (1s)		180 A			
Rated voltage		1000 V			
Impulse withstand voltage		8000 V			
Protection		IP20	NEMA 1		

The connecting capacity data for one Rigid - Solid/Stranded, or one Flexible conductor (when applicable) is a mandatory information required by IEC, UL and CSA standards (Copper conductors). All other data are provided as supplementary information only. For more details, please consult our CB, UL or CSA certificates and technical datasheet available on <http://www.TE.com>

Material specifications	Insulating material	Polyamide	
	Flammability	NF F 16 101	V0
Ambient temperature min/max	Service IEC 60068-2-1	-55 ... +110 °C	-67 ... +230 °F
	Storage	-55 ... +110 °C	-67 ... +230 °F
	Installing	-5 ... +40 °C	+23 ... +104 °F

All the main technical data provided are "manufacturer" values



Ordering details

Test connectors for 5.2 mm 0.205 in spacing terminal blocks

Description	Color	Type	Part Number	Pkg qty	Weight (1 pce) g
Test connectors 5.2 mm 0.205 in spacing	Dark grey	TC5	1SNK900200R0000	10	5.20
End module, 5.2 mm 0.205 in		TC5-R1	1SNK900201R0000	10	5.20

Ordering details

Test connectors for 6 mm 0.236 in spacing terminal blocks

Description	Color	Type	Part Number	Pkg qty	Weight (1 pce) g
Test connectors End module, 5.2 mm 0.205 in	Dark grey	TC5-R1	1SNK900201R0000	10	5.20
Spacers 0.8 mm 0.031 in spacing		ES-TC6	1SNK900105R0000	10	0.80

Ordering details

Test connectors for 8 mm 0.315 in spacing terminal blocks

Description	Color	Type	Part Number	Pkg qty	Weight (1 pce) g
Test connectors 5.2 mm 0.205 in spacing	Dark grey	TC5	1SNK900200R0000	10	5.20
End module, 5.2 mm 0.205 in		TC5-R1	1SNK900201R0000	10	5.20
Spacers 2.8 mm 0.110 in spacing		ES-TC8	1SNK900104R0000	10	1.40

Accessories

Description	Color	Type	Part Number	Pkg qty	Weight (1 pce) g
Cable clamps	Dark grey	PT-3	1SNK900625R0000	20	1.00
Terminal block markers	White	MG-CPM 13 41790	1SNB041790R0512	1960	0.23
		MC512	1SNK140000R0000	22	9.00
		MC512PA	1SNK149999R0000	20	10.00
	Universal wire markers holder	Grey	UMH	1SNK900611R0000	10

Technical data valid for copper conductors only.

Component plugs

Common terminal block accessories

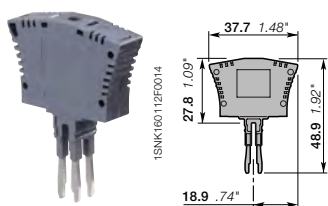

PG5

9.95 mm 0.392 in spacing

Mounting instructions

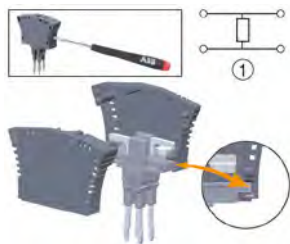

- Open the PG5-R2 with a flat screw-driver DIA . 3.5 mm 0.138 in,
- Use a soldering iron to fix your component,
- Close the PG5-R2,
- Plug-in in the terminal blocks jumper channels.

PG5-R2 component plugs

Description

- Component holder compatible with 5.2 mm 0.205 in spacing ZS4 feed-through terminal blocks,
- Fit components 16 x 16 x 8.5 mm 0.630 x 0.630 x 0.335 in (not supplied with plug) such as resistors, diodes, varistance,
- Direct plug-in into the terminal blocks jumper channels,
- Maximum dissipated power: 2 W.

Ordering details

Description	Color	Type	Part Number	Pkg qty	Weight (1 pce) g
Components insertion between 2 blocks	Dark grey <input checked="" type="checkbox"/>	PG5-R2	1SNK900403R0000	20	8.00

Main technical data

Material specifications	Insulating material	Polyamide			
	Flammability	V0			
	NF F 16 101	I2F2			
Ambient temperature min/max	Service IEC 60068-2-1	-55 ... +110 °C	-67 ... +230 °F		
	Storage	-55 ... +110 °C	-67 ... +230 °F		
	Installing	-5 ... +40 °C	+23 ... +104 °F		
		IEC	UL - CSA		
Rated current					
Rated voltage		250 V			
Impulse withstand voltage		4000 V			
Protection		IP20	NEMA 1		

All the main technical data provided are "manufacturer" values

	RoHS <input checked="" type="checkbox"/>				
--	--	--	--	--	--

Accessories

Description	Color	Type	Part Number	Pkg qty	Weight (1 pce) g
Terminal block markers	White <input type="checkbox"/>	MG-CPM 13 41790	1SNB041790R0512	1960	0.23
Blank card		MC512	1SNK140000R0000	22	9.00
		MC512PA	1SNK149999R0000	20	10.00
Universal wire markers holder	Grey <input type="checkbox"/>	UMH	1SNK900611R0000	10	0.20

Technical data valid for copper conductors only.

Component plugs

Common terminal block accessories

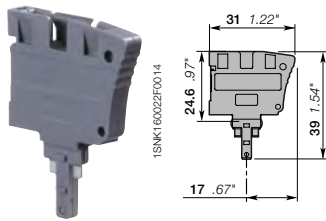

PG5

5.2 mm 0.205 in spacing

Mounting instructions



- Direct plug-in in disconnect with plug terminal block

PG5 component plugs

Description

- Ease the components installation (components not supplied with plug) with our quick plug-in mounting system which avoids soldering process,
- Accept 8.8 x 3.2 mm 0.346 x 0.125 in components such as resistors, diodes or subminiature fuses (fully encapsulated),
- Maximum dissipated power: 1 W.

Ordering details

Description	Color	Type	Part Number	Pkg qty	Weight (1 pce) g
Components in series with circuit	Dark grey <input checked="" type="checkbox"/>	PG5	1SNK900401R0000	20	3.50

Main technical data

Material specifications	Insulating material	Polyamide	
	Flammability	V0	
	NF F 16 101	I2F2	
Ambient temperature min/max	Service IEC 60068-2-1	-55 ... +110 °C	-67 ... +230 °F
	Storage	-55 ... +110 °C	-67 ... +230 °F
	Installing	-5 ... +40 °C	+23 ... +104 °F
		IEC	UL - CSA
Rated current			
Rated voltage	400 V	150 V	
Impulse withstand voltage	6000 V		
Protection	IP20	NEMA 1	

All the main technical data provided are "manufacturer" values

	RoHS				
	RoHS				

Accessories

Description	Color	Type	Part Number	Pkg qty	Weight (1 pce) g	
Terminal block markers	White <input type="checkbox"/>	MG-CPM 13 41790	1SNB041790R0512	1960	0.23	
Blank card	In polycarbonate	MC512	1SNK140000R0000	22	9.00	
		Blank card	MC512PA	1SNK149999R0000	20	10.00
Universal wire markers holder	5.2 mm 0.205 in spacing	Grey <input type="checkbox"/>	UMH	1SNK900611R0000	10	0.20

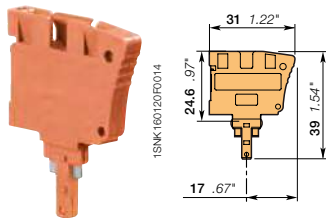

PG5

5.2 mm 0.205 in spacing

Mounting instructions



- PG5-R1 totally inserted: closed circuit,
- PG5-R1 inserted in central position: open circuit, plug secured in isolated central position

PG5-R1 disconnect plugs

Description

Allow disconnect function when associated with the disconnect with plug terminal blocks.

Ordering details

Description	Color	Type	Part Number	Pkg qty	Weight (1 pce) g
Equipped with linking bar	Orange <input checked="" type="checkbox"/>	PG5-R1	1SNK900402R0000	20	3.50

Main technical data

Material specifications	Insulating material	Polyamide	
	Flammability	V0	
	NF F 16 101	I2F3	
Ambient temperature min/max	Service IEC 60068-2-1	-55 ... +110 °C	-67 ... +230 °F
	Storage	-55 ... +110 °C	-67 ... +230 °F
	Installing	-5 ... +40 °C	+23 ... +104 °F
		IEC	UL - CSA
Rated current	18 A	20 A	
Rated voltage	400 V	150 V	
Impulse withstand voltage	6000 V		
Protection	IP20	NEMA 1	

All the main technical data provided are "manufacturer" values

	RoHS				
	RoHS				

Accessories

Description	Color	Type	Part Number	Pkg qty	Weight (1 pce) g	
Terminal block markers	White <input type="checkbox"/>	MG-CPM 13 41790	1SNB041790R0512	1960	0.23	
Blank card	In polycarbonate	MC512	1SNK140000R0000	22	9.00	
		Blank card	MC512PA	1SNK149999R0000	20	10.00
Universal wire markers holder	5.2 mm 0.205 in spacing	Grey <input type="checkbox"/>	UMH	1SNK900611R0000	10	0.20

Technical data valid for copper conductors only.

Tools

Common terminal block accessories



1SNK16024FC014

TO

TO screwdrivers

Description

Flat head screwdriver

Ordering details

Description	Color	Type	Part Number	Pkg qty	Weight (1 pce) g
Insulated screwdriver 1000V IEC dimensions 3.5 x 100 mm 0.138 x 3.94 in		TO3.5-100-INS	1SNK900644R0000	1	37.00
screwdriver 3.5 x 50 mm 0.138 x 1.97 in		TO3.5-50	1SNK900640R0000	12	22.00
screwdriver 3.5 x 50 mm 0.138 x 1.97 in Angled 60°		TO3.5-50-A	1SNK900659R0000	12	21.6
screwdriver 4 x 100 mm 0.157 x 3.94 in		TO4-100	1SNK900641R0000	1	42.00
screwdriver 5.5 x 125 mm 0.216 x 4.92 in		TO5.5-125	1SNK900642R0000	1	75.50
screwdriver 6.5 x 150 mm 0.256 x 5.90 in		TO6.5-150	1SNK900643R0000	1	121.00



1SNK160127P0014

PS

PS crimping tools

Description

- Crimp flexible conductors equipped with ferrules from 0.08 to 10 mm² 28 AWG to 7 AWG,
- Semi-automatic crimping tool.

Ordering details

Description	Color	Type	Part Number	Pkg qty	Weight (1 pce) g
180 mm 7.09 in length		PS-3	1SNK900650R0000	1	380.00

Technical data valid for copper conductors only.

1SNK16025S0201

End sections

PI-Spring terminal block accessories



1SNK160233V0014

EK2.5

EK2.5 end sections

Description

- Unique dark grey color that fits all terminal blocks colours and ease the identification of circuits within your terminal block assemblies,
- Compatible with ZK2.5, ZK2.5-PE, ZK4, ZK4-PE, ZK6 and ZK6-PE PI-Spring screwless terminal blocks.

Ordering details

Description	Color	Type	Part Number	Pkg qty	Weight (1 pce) g
2 mm 0.079 in spacing	Dark grey	EK2.5	1SNK705910R0000	20	1.80



1SNK160234V0014

EK2.5-3P

EK2.5-3P end sections

Description

- Unique dark grey color that fits all terminal blocks colours and ease the identification of circuits within your terminal block assemblies,
- Compatible with ZK2.5-3P, ZK2.5-PE-3P, ZK4-3P, ZK4-PE-3P, ZK2.5-S..., ZK2.5-SP and ZK2.5-SF... PI-Spring screwless terminal blocks.

Ordering details

Description	Color	Type	Part Number	Pkg qty	Weight (1 pce) g
2 mm 0.079 in spacing	Dark grey	EK2.5-3P	1SNK705911R0000	20	2.40



1SNK160235V0014

EK2.5-4P

EK2.5-4P end sections

Description

- Unique dark grey color that fits all terminal blocks colours and ease the identification of circuits within your terminal block assemblies,
- Compatible with ZK2.5-4P, ZK2.5-PE-4P, ZK4-4P and ZK4-PE-4P PI-Spring screwless terminal blocks.

Ordering details

Description	Color	Type	Part Number	Pkg qty	Weight (1 pce) g
2 mm 0.079 in spacing	Dark grey	EK2.5-4P	1SNK705912R0000	20	2.70

Main technical data

Material specifications	Insulating material	Polyamide			
	Flammability	V0			
	NF F 16 101	I2F2			
Ambient temperature min/max	Service IEC 60068-2-1	-55 ... +110 °C	-67 ... +230 °F		
	Storage	-55 ... +110 °C	-67 ... +230 °F		
	Installing	-5 ... +40 °C	+23 ... +104 °F		

All the main technical data provided are "manufacturer" values.

	RoHS				
	RoHS				

Technical data valid for copper conductors only.

End sections

PI-Spring terminal block accessories



1SNK160339V0014

EK2.5-S-4P

EK2.5-S-4P end sections

Description

- Unique dark grey color that fits all terminal blocks colours and ease the identification of circuits within your terminal block assemblies,
- Compatible with ZK2.5-S-4P, ZK2.5-SP-4P, ZK2.5-CH-4P... PI-Spring screwless terminal blocks.

Ordering details

Description	Color	Type	Part Number	Pkg qty	Weight (1 pce) g
2 mm 0.079 in spacing	Dark grey	EK2.5-S-4P	1SNK705913R0000	20	2,94

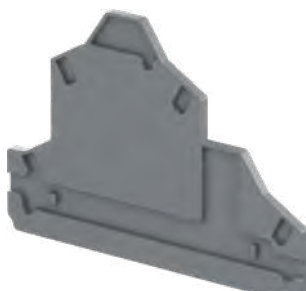

1SNK160237V0014

EK2.5-D2

EK2.5-D2 end sections

Description

- Compatible with ZK2.5-D2, ZK2.5-D2-PE, ZK2.5-D1 and ZK2.5-D1-PE PI-Spring screwless terminal blocks.

Ordering details

Description	Color	Type	Part Number	Pkg qty	Weight (1 pce) g
2 mm 0.079 in spacing	Dark grey	EK2.5-D2	1SNK705960R0000	20	3,40



1SNK160346V0014

EK2.5-T3

EK2.5-T3 end sections

Description

- Compatible with ZK2.5-T3, ZK2.5-T1, ZK2.5-T1-PE, ZK2.5-L-L-PE and ZK2.5-L-N-PE PI-Spring screwless terminal blocks.

Ordering details

Description	Color	Type	Part Number	Pkg qty	Weight (1 pce) g
0.8 mm 0.031 in spacing	Dark grey	EK2.5-T3	1SNK705961R0000	20	4,76

Main technical data

Material specifications	Insulating material	Polyamide			
	Flammability	V0			
	NF F 16 101	I2F2			
Ambient temperature min/max	Service IEC 60068-2-1	-55 ... +110 °C	-67 ... +230 °F		
	Storage	-55 ... +110 °C	-67 ... +230 °F		
	Installing	-5 ... +40 °C	+23 ... +104 °F		

All the main technical data provided are "manufacturer" values.

	RoHS				
	RoHS				

Technical data valid for copper conductors only.

1SNK160065S0201

End sections

PI-Spring terminal block accessories



1SNK160238V0014

EK6-3P

EK6-3P end sections

Description

- Compatible with ZK6-3P and ZK6-PE-3P PI-Spring screwless terminal blocks.

Ordering details

Description	Color	Type	Part Number	Pkg qty	Weight (1 pce) g
2 mm 0.079 in spacing	Dark grey	EK6-3P	1SNK708911R0000	20	2.80



1SNK160238V0014

EK10

EK10 end sections

Description

- Compatible with ZK10, ZK10-PE, ZK16 and ZK16-PE PI-Spring screwless terminal blocks.

Ordering details

Description	Color	Type	Part Number	Pkg qty	Weight (1 pce) g
2 mm 0.079 in spacing	Dark grey	EK10	1SNK710910R0000	20	3.30



1SNK160318V0014

EK10-3P

EK10-3P end sections

Description

- Unique dark grey color that fits all terminal blocks colours and ease the identification of circuits within your terminal block assemblies,
- Compatible with ZK10-3P, ZK10-PE-3P, ZK16-3P, ZK16-PE-3P... PI-Spring screwless terminal blocks.

Ordering details

Description	Color	Type	Part Number	Pkg qty	Weight (1 pce) g
2 mm 0.079 in spacing	Dark grey	EK10-3P	1SNK710911R0000	20	4.5

Main technical data

Material specifications	Insulating material	Polyamide			
	Flammability	V0			
	NF F 16 101	I2F2			
Ambient temperature min/max	Service IEC 60068-2-1	-55 ... +110 °C	-67 ... +230 °F		
	Storage	-55 ... +110 °C	-67 ... +230 °F		
	Installing	-5 ... +40 °C	+23 ... +104 °F		

All the main technical data provided are "manufacturer" values.

	RoHS								
	RoHS								

Technical data valid for copper conductors only.

Circuit separators

PI-Spring terminal blocks accessories



1SNK160240V0014

CS-R2

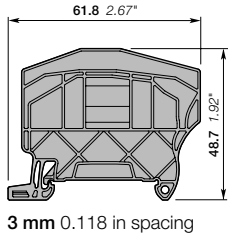

CS-R2 circuit separators

Description

- Compact circuits separator solution (only 3mm spacing) which provides a convenient visual identification of the several circuits within terminal assemblies,
- Unique top marking possibility that can replace the conventional solution of "end stop with label holder" for demanding applications with high space constraints, - Compatible with all PI-spring feed-through and ground terminal blocks up to 8 mm spacing,
- Mounting on DIN3-TH35 rail.

Ordering details

Description	Color	Type	Part Number	Pkg qty	Weight (1 pce) g
3 mm 0.118 in spacing	Dark grey <input checked="" type="checkbox"/>	CS-R2	1SNK900106R0000	20	3.80

Main technical data

Material specifications	Insulating material	Polyamide			
	Flammability	V0			
	NF F 16 101	I2F2			
Ambient temperature min/max	Service IEC 60068-2-1	-55 ... +110 °C	-67 ... +230 °F		
	Storage	-55 ... +110 °C	-67 ... +230 °F		
	Installing	-5 ... +40 °C	+23 ... +104 °F		

All the main technical data provided are "manufacturer" values

	RoHS RoHS																		
--	---------------------	--	--	--	--	--	--	--	--	--	--	--	--	--	--	--	--	--	--

Accessories

Description	Color	Type	Part Number	Pkg qty	Weight (1 pce) g
Terminal block markers	White <input type="checkbox"/>	MG-CPM 13 41791	1SNB041791R0612	1680	0.27
Labels	Yellow <input checked="" type="checkbox"/>	MG-VYT 46415	1SNB046415R0615	5250	0.04
	White <input type="checkbox"/>	MG-VYT 46915	1SNB046915R0615	5250	0.05
Blank card	In polycarbonate	White <input type="checkbox"/>	MC612	22	10.00
		Blank card	MC612PA	20	11.00
Universal wire markers holder 5.2 mm 0.205 in spacing	Grey <input type="checkbox"/>	UMH	1SNK900611R0000	10	0.20

Technical data valid for copper conductors only.

Circuit separators

PI-Spring terminal blocks accessories



1SNK160241V0014

CS-R3

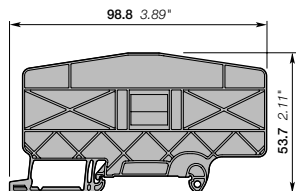

3 mm 0.118 in spacing

CS-R3 circuit separators

Description

- Compact circuits separator solution (only 3mm spacing) which provides a convenient visual identification of the several circuits within terminal assemblies,
- Unique top marking possibility that can replace the conventional solution of "end stop with label holder" for demanding applications with high space constraints,
- Compatible with all single deck PI-spring terminal blocks and ZS10-ST...terminal blocks ,
- Mounting on DIN3-TH35 rail.

Ordering details

Description	Color	Type	Part Number	Pkg qty	Weight (1 pce) g
3 mm 0.118 in spacing	Dark grey <input checked="" type="checkbox"/>	CS-R3	1SNK900107R0000	20	6.40

Main technical data

Material specifications	Insulating material	Polyamide			
	Flammability	V0			
	NF F 16 101	I2F2			
Ambient temperature min/max	Service IEC 60068-2-1	-55 ... +110 °C	-67 ... +230 °F		
	Storage	-55 ... +110 °C	-67 ... +230 °F		
	Installing	-5 ... +40 °C	+23 ... +104 °F		

All the main technical data provided are "manufacturer" values

	RoHS																		
	RoHS																		

Accessories

Description	Color	Type	Part Number	Pkg qty	Weight (1 pce) g	
Terminal block markers	White <input type="checkbox"/>	MG-CPM 13 41790	1SNB041790R0512	1960	0.23	
		MG-CPM 13 41791	1SNB041791R0612	1680	0.27	
Labels	Yellow <input checked="" type="checkbox"/>	MG-VYT 46415	1SNB046415R0615	5250	0.04	
	White <input type="checkbox"/>	MG-VYT 46915	1SNB046915R0615	5250	0.05	
Blank card	White <input type="checkbox"/>	In polycarbonate	MC512	1SNK140000R0000	22	9.00
		Blank card	MC512PA	1SNK149999R0000	20	10.00
		In polycarbonate	MC612	1SNK150000R0000	22	10.00
		Blank card	MC612PA	1SNK159999R0000	20	11.00
Universal wire markers holder 5.2 mm 0.205 in spacing	Grey <input type="checkbox"/>	UMH	1SNK900611R0000	10	0.20	

Technical data valid for copper conductors only.

Shield connectors

PI-Spring terminal block accessories



1SNK160267R0014

SHBP/SHB

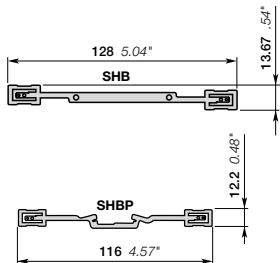

SHBP/SHB shield connectors for PI-Spring terminal blocks

Description

- Ensure the continuity of your shield connection,
- Various connection solutions available: RILS cable ties, soldering, quick-connect.

Ordering details

Description	Color	Type	Part Number	Pkg qty	Weight (1 pce) g
Compatible with ZK2.5 and ZK2.5-S terminal blocks		SHBP	1SNK900601R0000	20	4.10
Compatible with ZS and ZK double deck terminal blocks		SHB	1SNK900602R0000	20	4.90

Main technical data

Material specifications	Insulating material				
	Flammability				
Ambient temperature min/max	NF F 16 101				
	Service IEC 60068-2-1	-55 ... +110 °C	-67 ... +230 °F		
	Storage	-55 ... +110 °C	-67 ... +230 °F		
	Installing	-5 ... +40 °C	+23 ... +104 °F		

SHBP	IEC	UL - CSA	Ex e
Rated voltage	100 V		50 V

All the main technical data provided are "manufacturer" values

RoHS																			
RoHS																			

Accessories for screw clamp and PI-Spring terminal blocks

Description	Color	Type	Part Number	Pkg qty	Weight (1 pce) g
Cable ties	For SNK shield connector	RILS	1SNK900627R0000	10	0.30

Mounting instructions



- SHBS is directly fixed on the terminal block,
- SHB is fixed on the ES4-D2 end section,
- SHBP is directly fixed on the terminal block,
- Connect the cable shielding on the shielding connector with:
- RILS cable ties,
- quick-connect (the shield connector needs to be prepared),
- soldering iron.

Technical data valid for copper conductors only.

End sections

Screw clamp terminal block accessories



1SNK161013F0014

ES4

ES4 end sections

Description

- Unique dark grey color that fits all terminal blocks colours and ease the identification of circuits within your terminal block assemblies,
- Compatible with feed-through, ground and disconnect screw clamp terminal blocks.

Ordering details

Description	Color	Type	Part Number	Pkg qty	Weight (1 pce) g
2.2 mm 0.087 in spacing	Dark grey	ES4	1SNK505910R0000	20	2.20



1SNK160229V0014

ES6-3S

ES6-3S end sections

Description

- Compatible with ZS6-3S and ZS6-3S-PE terminal blocks.

Ordering details

Description	Color	Type	Part Number	Pkg qty	Weight (1 pce) g
2.2 mm 0.087 in spacing	Dark grey	ES6-3S	1SNK505912R0000	20	2.50



1SNK160230V0014

ES6-4S

ES6-4S end sections

Description

- Compatible with ZS6-4S, ZS6-4S-PE, ZS6-S-4S-T2 and ZS4-PE-R2 terminal blocks.

Ordering details

Description	Color	Type	Part Number	Pkg qty	Weight (1 pce) g
2.2 mm 0.087 in spacing	Dark grey	ES6-4S	1SNK505911R0000	20	3.10



1SNK161012F0014

ES4-D2

ES4-D2 end sections

Description

- Unique dark grey color that fits all terminal blocks colours and ease the identification of circuits within your terminal block assemblies,
- Compatible with double deck screw clamp terminal blocks

Ordering details

Description	Color	Type	Part Number	Pkg qty	Weight (1 pce) g
2.55 mm 0.100 in spacing	Dark grey	ES4-D2	1SNK505960R0000	20	4.10

Main technical data

Material specifications	Insulating material	Polyamide			
	Flammability	V0			
	NF F 16 101	I2F2			
Ambient temperature min/max	Service IEC 60068-2-1	-55 ... +110 °C	-67 ... +230 °F		
	Storage	-55 ... +110 °C	-67 ... +230 °F		
	Installing	-5 ... +40 °C	+23 ... +104 °F		

All the main technical data provided are "manufacturer" values.

	RoHS				
	RoHS				

Technical data valid for copper conductors only.

End sections

Screw clamp terminal block accessories



1SNK1602310014

ES4-T3

ES4-T3 end sections

Description

– Compatible with ZS4-T3 terminal block.

Ordering details

Description	Color	Type	Part Number	Pkg qty	Weight (1 pce) g
0.8 mm 0.031 in spacing	Dark grey	ES4-T3	1SNK505961R0000	20	4.20



1SNK16102650014

ES4-SF

ES4-SF end sections

Description

– Compatible with fuse ZS4-SF1... and disconnect screw clamp terminal blocks ZS4-S-R3.

Ordering details

Description	Color	Type	Part Number	Pkg qty	Weight (1 pce) g
1.5 mm 0.059 in spacing	Dark grey	ES4-SF	1SNK508960R0000	20	1.80



1SNK16023110014

ES4-D2-SF1

ES4-D2-SF1 end sections

Description

– Compatible with ZS4-D2-SF1 ... terminal blocks.

Ordering details

Description	Color	Type	Part Number	Pkg qty	Weight (1 pce) g
2.5 mm 0.098 in spacing	Dark grey	ES4-D2-SF1	1SNK508911R0000	20	5.00



1SNK161072F0014

ES10-ST

ES10-ST end sections

Description

– Unique dark grey color that fits all test disconnect terminal blocks ZS10-ST... and ease the identification of circuits within your terminal block assemblies,
– Also compatible with ZS10-R1 and ZS10-PE-R1.

Ordering details

Description	Color	Type	Part Number	Pkg qty	Weight (1 pce) g
2 mm 0.079 in spacing	Dark grey	ES10-ST	1SNK508910R0000	20	3.5

Accessories

Description	Color	Type	Part Number	Pkg qty	Weight (1 pce) g
Circuit separators	Dark grey	CS	1SNK900101R0000	20	0.20

Main technical data

Material specifications	Insulating material	Polyamide			
	Flammability	V0			
	NF F 16 101	I2F2			
Ambient temperature min/max	Service IEC 60068-2-1	-55 ... +110 °C	-67 ... +230 °F		
	Storage	-55 ... +110 °C	-67 ... +230 °F		
	Installing	-5 ... +40 °C	+23 ... +104 °F		

All the main technical data provided are "manufacturer" values.

	RoHS				
	RoHS				

Technical data valid for copper conductors only.

1SNK160062S0201

Screw jumper bars

Screw clamp terminal block accessories



1SNK160212F0014

JB8
8 mm 0.315 in spacing

Mounting instructions

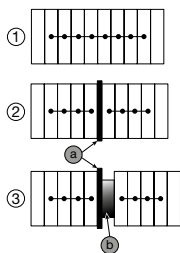

- 1 - Rated voltage: 160 V (IEC) / Not authorized (UL)
- 2 - Rated voltage: 320 V (IEC) / Not authorized (UL)
- 3 - Rated voltage: 1000 V (IEC) / 300 V (UL)
- a - End section ES10-ST
- b - End stop BAZ1

JB8 jumper bars

Description

Insulated jumper bar with screw mounting.

Ordering details

Description		Color	Type	Part Number	Pkg qty	Weight (1 pce) g
8 mm 0.315 in spacing	2 poles	Orange	JB8-2-R1	1SNK908902R0000	10	7.6
	3 poles		JB8-3-R1	1SNK908903R0000	10	11.6
	4 poles		JB8-4-R1	1SNK908904R0000	10	15.5
	5 poles		JB8-5-R1	1SNK908905R0000	10	19.4
	10 poles		JB8-10-R1	1SNK908910R0000	10	39.00

Main technical data

Material specifications	Insulating material	Polyamide		Rail	
	Flammability	V0		Tool	Flat screwdriver Ø 3.5 mm Ø 0.138 in
	NF F 16 101	I2F3			
Ambient temperature min/max	Service IEC 60068-2-1	-55 ... +110 °C	-67 ... +230 °F	Torque	0.7 Nm ± 0.1 6.2 lb.in ± 0.88
	Storage	-55 ... +110 °C	-67 ... +230 °F		
	Installing	-5 ... +40 °C	+23 ... +104 °F		
Rated current		IEC	UL - CSA	Ex e	
Rated voltage	Standard use	50 A	51 A		
	Alternated poles	160 V		Not authorized	
Impulse withstand voltage					
Protection		IP20	NEMA 1		
All the main technical data provided are "manufacturer" values					

Technical data valid for copper conductors only.

Screw jumper bars

Screw clamp terminal block accessories



1SNK16012AF0014

JB16
16 mm 0.630 in spacing

Mounting instructions



- With flat pliers, cut out the partitions on the terminal block insulating body. Be careful to not cut out the jumpered terminal blocks partitions at both ends of the assembly in order to maintain the IP20, Nema1 protection and insulation,
- Install the jumper bar with the recommended tool and torque.

JB16 jumper bars

Description

Insulated jumper bar with screw mounting.

Ordering details

Description		Color	Type	Part Number	Pkg qty	Weight (1 pce) g
16 mm 0.630 in spacing	2 poles	Orange	JB16-2	1SNK916302R0000	10	10.00
	3 poles		JB16-3	1SNK916303R0000	10	16.00
	4 poles		JB16-4	1SNK916304R0000	10	22.00
	5 poles		JB16-5	1SNK916305R0000	10	28.00
	10 poles		JB16-10	1SNK916310R0000	10	56.60

Main technical data

Material specifications	Insulating material Flammability NF F 16 101	Polyamide V0 I2F3	Rail		
Ambient temperature min/max	Service IEC 60068-2-1	-55 ... +110 °C	-67 ... +230 °F	Tool	Flat screwdriver Ø 5.5 mm Ø 0.217 in 1.2 Nm ± 0.1 10.6 lb.in ± 0.885
	Storage	-55 ... +110 °C	-67 ... +230 °F	Torque	
	Installing	-5 ... +40 °C	+23 ... +104 °F		
Rated current		IEC 125 A	UL - CSA 150 A	Ex e	
Rated voltage	Standard use	1000 V	600 V		
		Alternated poles			Not authorized
Impulse withstand voltage		8000 V			
Protection		IP20	NEMA 1		

All the main technical data provided are "manufacturer" values

RoHS
RoHS

JB22 jumper bars

Description

Screw jumper bars



1SNK16010CF0014

JB22
22 mm 0.866 in spacing

Mounting instructions



- With flat pliers, cut out the partitions on the terminal block insulating body. Be careful to not cut out the jumpered terminal blocks partitions at both ends of the assembly in order to maintain the IP20, Nema1 protection and insulation,
- Install the jumper bar with the recommended tool and torque.

Ordering details

Description		Color	Type	Part Number	Pkg qty	Weight (1 pce) g
22 mm 0.866 in spacing	2 poles		JB22-2	1SNK922302R0000	5	27.00
	3 poles		JB22-3	1SNK922303R0000	5	43.30
	5 poles		JB22-5	1SNK922305R0000	5	76.10
	10 poles		JB22-10	1SNK922310R0000	5	157.40

Main technical data

Material specifications	Insulating material Flammability NF F 16 101	Polyamide	Rail		
Ambient temperature min/max	Service IEC 60068-2-1	-55 ... +110 °C	-67 ... +230 °F	Tool	Allen key Ø 4 mm Ø 0.157 in 2 Nm ± 0.4 17.7 lb.in ± 3.54
	Storage	-55 ... +110 °C	-67 ... +230 °F	Torque	
	Installing	-5 ... +40 °C	+23 ... +104 °F		
Rated current		IEC 192 A	UL - CSA 175 A	Ex e	
Rated voltage	Standard use	1000 V	600 V	630 V	
		Alternated poles			Not authorized
Impulse withstand voltage		8000 V			
Protection		IP20			

All the main technical data provided are "manufacturer" values

RoHS
RoHS

Technical data valid for copper conductors only.

Screw jumper bars

Screw clamp terminal block accessories



1SNK160100F0014

BJMI31

31 mm 1.22 in spacing

Mounting instructions



- With flat pliers, cut out the partitions on the terminal block insulating body. Be careful to not cut out the jumpered terminal blocks partitions at both ends of the assembly in order to maintain the IP20, Nema1 protection and insulation,
- Install the jumper bar with the recommended tool and torque.

BJMI31 jumper bars

Description

Screw jumper bars

Ordering details

Description		Color	Type	Part Number	Pkg qty	Weight (1 pce) g
31mm 1.220 in spacing	2 poles		BJMI31.2	1SNA206053R0700	1	120.00
	3 poles		BJMI31.3	1SNA206054R0000	1	190.00

Main technical data

Material specifications	Insulating material			Rail		
	Flammability			Tool		Allen key Ø 5 mm Ø 0.196 in
Ambient temperature min/max	Service IEC 60068-2-1	-55 ... +110 °C	-67 ... +230 °F	Torque		3 Nm ± 0.4 26.55 lb.in ± 3.54
	Storage	-55 ... +110 °C	-67 ... +230 °F			
	Installing	-5 ... +40 °C	+23 ... +104 °F			
Rated current	Standard use	IEC	UL - CSA	Ex e		
		309 A	445 A			
Rated voltage	Standard use	1000 V	600 V			
		Alternated poles		Not authorized		
Impulse withstand voltage	8000 V					
Protection	IP20					

All the main technical data provided are "manufacturer" values

	RoHS					
	RoHS					



1SNK160100F0014

BJMI36

36 mm 1.42 in spacing

Mounting instructions

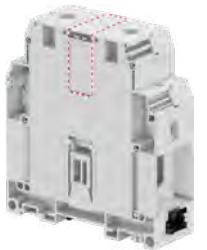

- With flat pliers, cut out the partitions on the terminal block insulating body. Be careful to not cut out the jumpered terminal blocks partitions at both ends of the assembly in order to maintain the IP20, Nema1 protection and insulation,
- Install the jumper bar with the recommended tool and torque.

BJMI36 jumper bars

Description

Screw jumper bars

Ordering details

Description		Color	Type	Part Number	Pkg qty	Weight (1 pce) g
36mm 1.4117 n spacing	2 poles		BJMI36.2	1SNA206126R2500	1	170.00
	3 poles		BJMI36.3	1SNA206223R0600	1	260.00

Main technical data

Material specifications	Insulating material			Rail		
	Flammability			Tool		Allen key Ø 5 mm Ø 0.196 in
Ambient temperature min/max	Service IEC 60068-2-1	-55 ... +110 °C	-67 ... +230 °F	Torque		3 Nm ± 0.4 26.55 lb.in ± 3.54
	Storage	-55 ... +110 °C	-67 ... +230 °F			
	Installing	-5 ... +40 °C	+23 ... +104 °F			
Rated current	Standard use	IEC	UL - CSA	Ex e		
		415 A	620 A			
Rated voltage	Standard use	1000 V	600 V			
		Alternated poles		Not authorized		
Impulse withstand voltage	8000 V					
Protection	IP20					

All the main technical data provided are "manufacturer" values

	RoHS					
	RoHS					

Technical data valid for copper conductors only.

Lateral jumper bars

Screw clamp terminal block accessories



1SN160112P0014

PC8
8 mm 0.315 in spacing

Mounting instructions for ZS10-ST...

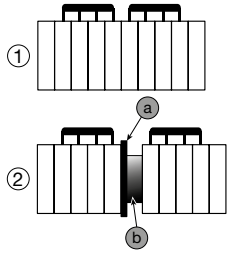

- 1 - Rated voltage: 630 V (IEC) / 150 V (UL)
- 2 - Rated voltage: 630 V (IEC) / 300 V (UL)
- a - End section ES10-ST
- b - End stop BAZ1

PC8 lateral jumper bars

Description

IP20 Comb jumper bars,

- direct insertion in the screw clamp before tightening the screws, above the eventual conductor (if conductor used with ferrule, we recommend the use of long ferrule for optimized mounting ergonomony with test disconnect terminal blocks),
- Multiple versions available in pre-cut poles for test disconnect terminal blocks applications.

Ordering details

Description	Color	Type	Part Number	Pkg qty	Weight (1 pce) g
Lateral jumper bars					
8 mm 0.315 in spacing	Black ■	PC8-2	1SNA116538R1700	10	3.00
		PC8-3	1SNA116539R1000	10	4.00
		PC8-4	1SNA116540R2500	10	6.00
		PC8-10	1SNA163313R2400	10	14.00
Lateral jumper bars pre-cut poles					
8 mm 0.315 in spacing	Black ■	PC8-R1	1SNA400711R0600	10	6.60
		PC8-R2	1SNA400712R0700	10	7.80
		PC8-R3	1SNA400713R0000	10	9.00
		PC8-R4	1SNA400724R0300	10	4.50
		PC8-R5	1SNA400842R0000	10	6.60
		PC8-R6	1SNA400843R0000	10	6.60
		PC8-R7	1SNA400849R0000	10	6.60
		PC8-R8	1SNA400850R0000	10	7.80

Main technical data

Material specifications	Insulating material	Polyamide			
	Flammability	V0			
	NF F 16 101	I2F3			
Ambient temperature min/max	Service IEC 60068-2-1	-55 ... +110 °C	-67 ... +230 °F		
	Storage	-55 ... +110 °C	-67 ... +230 °F		
	Installing	-5 ... +40 °C	+23 ... +104 °F		

All the main technical data provided are "manufacturer" values

RoHS
RoHS



1SN160537F0014

PC81
8 mm 0.315 in spacing

PC81 lateral jumper bars

Description

Comb-type jumper bar, allows the connection of consecutive blocks or not by one compression clamp connection.

Ordering details

Description	Color	Type	Part Number	Pkg qty	Weight (1 pce) g
8 mm 0.315 in spacing	Grey ■	PC81-10	1SNA173523R1100	10	5.00

Main technical data

Material specifications	Insulating material	Brass/polyamide			
	Flammability	V0			
	NF F 16 101	I2F3			
Ambient temperature min/max	Service IEC 60068-2-1	-55 ... +110 °C	-67 ... +230 °F		
	Storage	-55 ... +110 °C	-67 ... +230 °F		
	Installing	-5 ... +40 °C	-23 ... +104 °F		

All the main technical data provided are "manufacturer" values

RoHS
RoHS

Technical data valid for copper conductors only.

Circuit separators

Screw clamp terminal block accessories



1SNK16002P0014

CS
0 mm 0 in spacing

Mounting instructions



CS circuit separators

Description

- The CS circuit separator avoids the derating of terminal blocks when cut jumper bars JB are used,
- Compatible with feed-through terminal blocks up to 16 mm² 4 AWG,
- Without spacing loss.

Ordering details

Description	Color	Type	Part Number	Pkg qty	Weight (1 pce) g
0 mm 0 in spacing	Dark grey <input checked="" type="checkbox"/>	CS	1SNK900101R0000	20	0.20

Main technical data

Material specifications	Insulating material	Polyamide	
	Flammability	V0	
	NF F 16 101	I2F2	
Ambient temperature min/max	Service IEC 60068-2-1	-55 ... +110 °C	-67 ... +230 °F
	Storage	-55 ... +110 °C	-67 ... +230 °F
	Installing	-5 ... +40 °C	+23 ... +104 °F

All the main technical data provided are "manufacturer" values

RoHS <input checked="" type="checkbox"/>	RoHS									
--	------	--	--	--	--	--	--	--	--	--



1SNK16003P0014

CS-R1

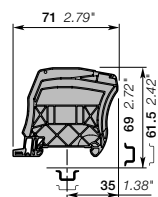

3 mm 0.118 in spacing

CS-R1 circuit separators

Description

- Ease the visual identification of the several circuits within your terminal block assemblies,
- Compatible with feed-through terminal blocks up to 35 mm² 0 AWG,
- Intermediate cover holder for CO protective cover,
- Mounting on DIN3-TH35 rail.

Ordering details

Description	Color	Type	Part Number	Pkg qty	Weight (1 pce) g
3 mm 0.118 in spacing	Dark grey <input checked="" type="checkbox"/>	CS-R1	1SNK900103R0000	20	5.20

Main technical data

Material specifications	Insulating material	Polyamide	
	Flammability	V0	
	NF F 16 101	I2F2	
Ambient temperature min/max	Service IEC 60068-2-1	-55 ... +110 °C	-67 ... +230 °F
	Storage	-55 ... +110 °C	-67 ... +230 °F
	Installing	-5 ... +40 °C	+23 ... +104 °F

All the main technical data provided are "manufacturer" values

RoHS <input checked="" type="checkbox"/>	RoHS									
--	------	--	--	--	--	--	--	--	--	--

Mounting instructions



Accessories

Description	Color	Type	Part Number	Pkg qty	Weight (1 pce) g
Terminal block markers	White <input type="checkbox"/>	MG-CPM 13 41790	1SNB041790R0512	1960	0.23
Blank card		MC512	1SNK140000R0000	22	9.00
		MC512PA	1SNK149999R0000	20	10.00
Universal wire markers holder 5.2 mm 0.205 in spacing	Grey <input type="checkbox"/>	UMH	1SNK900611R0000	10	0.20

Technical data valid for copper conductors only.

Shield connectors

Screw clamp terminal block accessories



SHBS/SHB

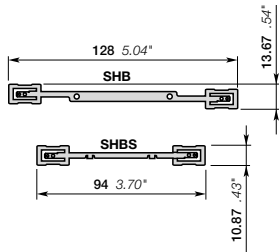

SHBS/SHB shield connectors

Description

- Ensure the continuity of your shield connection,
- Various connection solutions available: RILS cable ties, soldering, quick-connect.

Ordering details

Description	Color	Type	Part Number	Pkg qty	Weight (1 pce) g
Compatible with ZS feed-through terminal blocks		SHBS	1SNK900600R0000	20	3.50
Compatible with ZS and ZK double deck terminal blocks		SHB	1SNK900602R0000	20	4.90

Main technical data

Material specifications	Insulating material				
	Flammability				
Ambient temperature min/max	NF F 16 101				
	Service IEC 60068-2-1	-55 ... +110 °C	-67 ... +230 °F		
	Storage	-55 ... +110 °C	-67 ... +230 °F		
	Installing	-5 ... +40 °C	+23 ... +104 °F		

SHBS	IEC	UL - CSA	Ex e
Rated voltage	320 V		125 V

All the main technical data provided are "manufacturer" values

	RoHS								
	RoHS								

Accessories for screw clamp and PI-Spring terminal blocks

Description	Color	Type	Part Number	Pkg qty	Weight (1 pce) g
Cable ties	For SNK shield connector	RILS	1SNK900627R0000	10	0.30

Mounting instructions



- SHBS is directly fixed on the terminal block,
- SHB is fixed on the ES4-D2 end section,
- SHBP is directly fixed on the terminal block,
- Connect the cable shielding on the shielding connector with:
- RILS cable ties,
- quick-connect (the shield connector needs to be prepared),
- soldering iron.

Technical data valid for copper conductors only.

PL protecting covers

Screw clamp terminal block accessories



1SNK16006P0014

PL

Mounting instructions

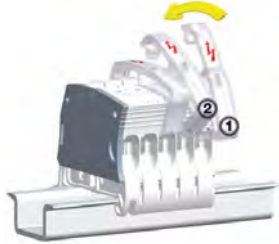

- The mounting of the PL does not require a screwdriver,
- The dismantling of the PL requires a screwdriver DIA .4 mm 0.160 in, the screwdriver must be positioned in the cover centered hole.

Description

- Prohibit access to the screw clamps,
- Indicate live circuits.

Ordering details

Description	Color	Type	Part Number	Pkg qty	Weight (1 pce) g
5.2 mm 0.205 in spacing	Transparent	<input checked="" type="checkbox"/> PL5	1SNK900618R0000	10	1.50
6 mm 0.236 in spacing		PL6	1SNK900619R0000	10	1.80
8 mm 0.315 in spacing		PL8	1SNK900620R0000	10	2.60
10 mm 0.394 in spacing		PL10	1SNK900621R0000	10	3.10
16 mm 0.630 in spacing		PL16	1SNK900622R0000	10	4.60

Main technical data

Material specifications	Insulating material	Polycarbonate	
	Flammability	V2	
Ambient temperature min/max	NF F 16 101		
	Service IEC 60068-2-1	-55 ... +110 °C	-67 ... +230 °F
	Storage	-55 ... +110 °C	-67 ... +230 °F
	Installing	-5 ... +40 °C	+23 ... +104 °F

Mounting instructions

Tool		Flat screwdriver Ø 4 mm Ø 0.157 in
------	--	--

All the main technical data provided are "manufacturer" values

	RoHS RoHS																		
--	---------------------	--	--	--	--	--	--	--	--	--	--	--	--	--	--	--	--	--	--

Technical data valid for copper conductors only.

Protecting covers

Screw clamp terminal block accessories



1SNK160110F0014

CO

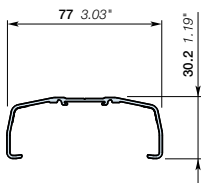

CO protecting covers

Description

- Restrict access to your assembly with the protecting cover CO installed with KCO mounting kit (2 end stops, 2 sealing accessories),
- Compatible with SNK feed-through terminal blocks up to 35 mm² 0 AWG.

Ordering details

Description	Color	Type	Part Number	Pkg qty	Weight (1 pce) g
1 m 39.4 in length	Transparent <input checked="" type="checkbox"/>	CO	1SNK900604R0000	1	300.00

Main technical data

Material specifications	Insulating material	PVC	
	Flammability	V0	
Ambient temperature min/max	NF F 16 101		
	Service IEC 60068-2-1	-55 ... +80 °C	-67 ... +176 °F
	Storage	-55 ... +80 °C	-67 ... +176 °F
	Installing	-5 ... +40 °C	+23 ... +104 °F

All the main technical data provided are "manufacturer" values

RoHS
RoHS

Accessories

Description	Color	Type	Part Number	Pkg qty	Weight (1 pce) g
Protecting cover kits	Dark grey <input checked="" type="checkbox"/>	KCO	1SNK900624R0000	1	47.80
Label	White <input type="checkbox"/>	PAM43020	1SNA235106R2600	20	27.00

Mounting instructions



Restrict access to the circuit by sealing the cover:

- Drill on the CO center line at 5 mm 0.197 in from the extremity with 5 mm 0.197 in diameter drill,
- Pass the sealing collar through the CO and KCO holes.



1SNK160144F0014

KCO

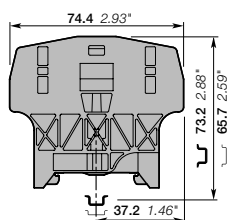

KCO protecting cover kits

Description

Mount your protecting cover with the KCO versatile mounting kit (2 end stops, 2 sealing accessories):

- Maintain the cover,
- Reliably seal the access to the terminal assembly if needed,
- Use it as well as an end stop.

Ordering details

Description	Color	Type	Part Number	Pkg qty	Weight (1 pce) g
Mounting kit for cover CO	Dark grey <input checked="" type="checkbox"/>	KCO	1SNK900624R0000	1	47.80

Main technical data

Material specifications	Insulating material	Polyamide		Rail	G32, TH 35-7.5,
	Flammability	V0		Tool	TH 35-15, TH 15-5.5
Ambient temperature min/max	NF F 16 101				Flat screwdriver
	Service IEC 60068-2-1	-55 ... +110 °C	-67 ... +230 °F		Ø 4 mm
	Storage	-55 ... +110 °C	-67 ... +230 °F		Ø 0.157 in
	Installing	-5 ... +40 °C	+23 ... +104 °F		

All the main technical data provided are "manufacturer" values

RoHS
RoHS

Technical data valid for copper conductors only.

Short circuit bridges

Screw clamp terminal block accessories



SC-JB8

8 mm 0.315 in spacing

1SNK160221F0014

SC-JB8 short circuit bridges

Description

- Allow safe short-circuiting of current Transformers circuits,
- Insulated,
- Fully operated by screwdriver,
- Short circuited fixed position secured thanks to AJS9 tightening,
- Adapted hook shape maintains the bridge on the terminal block in the non short-circuited position,
- The orange version can be used as fixed jumpers.

Ordering details

Description		Color	Type	Part Number	Pkg qty	Weight (1 pce) g
8 mm 0.315 in spacing	2 poles	Yellow ■	SC-JB8-2	1SNK900652R0000	25	2.00
	3 poles		SC-JB8-3	1SNK900653R0000	25	3.4
	4 poles		SC-JB8-4	1SNK900654R0000	25	4.7
	3/5 poles		SC-JB8-5	1SNK900655R0000	25	4.7
	3 poles		Orange ■	SC-JB8-3-OR	1SNK900657R0000	25
	4 poles	SC-JB8-4-OR		1SNK900658R0000	25	

Main technical data

Material specifications	Insulating material	Polyamide			
	Flammability	V0			
	NF F 16 101	I2F3			
Ambient temperature min/max	Service IEC 60068-2-1	-55 ... +110 °C	-67 ... +230 °F		
	Storage	-55 ... +110 °C	-67 ... +230 °F		
	Installing	-5 ... +40 °C	+23 ... +104 °F		

All the main technical data provided are "manufacturer" values

	RoHS																		
	RoHS																		

Technical data valid for copper conductors only.

End sections

Pluggable terminal block accessories



1SNK805910R0000

EDK2.5-22

EDK2.5-22 end sections

Description

– Compatible with ZDK2.5-22 and ZDK4-22 pluggable terminal blocks.

Description	Color	Type	Part Number	Pkg qty	Weight 1 pce g
2.2 mm 0.087 in spacing	Dark grey	■ EDK2.5-22	1SNK805910R0000	20	3.08



1SNK805914R0000

EDK2.5-21

EDK2.5-21 end sections

Description

– Compatible with ZDK2.5-11, ZDK2.5-11-BL and ZDK2.5-11-PE pluggable terminal blocks.

Description	Color	Type	Part Number	Pkg qty	Weight 1 pce g
1.5 mm 0.059 in spacing	Dark grey	■ EDK2.5-21	1SNK805914R0000	20	1.90



1SNK805915R0000

EDK2.5-11

EDK2.5-11 end sections

Description

– Compatible with ZDK2.5-11 pluggable terminal blocks.

Description	Color	Type	Part Number	Pkg qty	Weight 1 pce g
1.5 mm 0.059 in spacing	Dark grey	■ EDK2.5-11	1SNK805915R0000	20	1.49



1SNK805913R0000

EDK2.5-D

EDK2.5-D end sections

Description

– Compatible with ZDK2.5-D2, ZDK2.5-D2-BL, ZDK2.5-D1, ZDK2.5-D1-PE and ZDK2.5-D2-PE pluggable terminal blocks.

Description	Color	Type	Part Number	Pkg qty	Weight 1 pce g
2 mm 0.079 in spacing	Dark grey	■ EDK2.5-D	1SNK805913R0000	20	3.88

Main technical data

Material specifications	Insulating material	Polyamide		
	Flammability	V0		
	NF F 16 101	I2F2		
Ambient temperature min/max	Service IEC 60068-2-1	-55 ... +110 °C	-67 ... +230 °C	
	Storage	-55 ... +110 °C	-67 ... +230 °C	
	Installing	-5 ... +40 °C	+23 ... +104 °C	

All the main technical data provided are "manufacturer" values.

RoHS
RoHS

Technical data valid for copper conductors only.

1SNK164-0335/021

End sections

Pluggable terminal block accessories



1SNK164023V0014

ED2.5-22

ED2.5-22 end sections

Description

– Compatible with ZD2.5-22 and ZD2.5-22-PE pluggable terminal blocks.

Ordering details

Description	Color	Type	Part Number	Pkg qty	Weight (1 pce) g
2 mm 0.079 in spacing	Dark grey	ED2.5-22	1SNK805917R0000	20	3.64



1SNK164032V0014

EDS4-22

EDS4-22 end sections

Description

– Compatible with ZDS4-22 pluggable terminal block.

Ordering details

Description	Color	Type	Part Number	Pkg qty	Weight (1 pce) g
0.8 mm 0.031 in spacing	Dark grey	EDS4-22	1SNK805911R0000	20	1.85

Main technical data

Material specifications	Insulating material	Polyamide	
	Flammability	V0	
	NF F 16 101	I2F2	
Ambient temperature min/max	Service IEC 60068-2-1	-55 ... +110 °C	-67 ... +230 °C
	Storage	-55 ... +110 °C	-67 ... +230 °C
	Installing	-5 ... +40 °C	+23 ... +104 °C

All the main technical data provided are "manufacturer" values.

RoHS																			
RoHS																			

Technical data valid for copper conductors only.

Coding pegs - Locking devices

Pluggable terminal block accessories



1SNK160288V0014

COP

COP coding pegs

Description

– The coding pegs prevent plugs to be inserted into the wrong circuit.

Ordering details

Description	Color	Type	Part Number	Pkg qty	Weight (1 pce)
	Dark grey	COP-ZD	1SNK900636R0000	10	3.57

Main technical data

Material specifications	Insulating material	Polyamide	
	Flammability	V0	
	NF F 16 101	I2F2	
Ambient temperature min/max	Service IEC 60068-2-1	-55 ... +110 °C	-67 ... +230 °F
	Storage	-55 ... +110 °C	-67 ... +230 °F
	Installing	-5 ... +40 °C	+23 ... +104 °F

All the main technical data provided are "manufacturer" values.

RoHS

Mounting instructions



1SNK160315V0014

VR

9.4 mm 0.370 in spacing

VR locking devices

Description

- Automatic locking providing excellent plug withstand in case of accidental pulling,
- Lock safely one or two CDK or CDS plugs on ZDK and ZDS pluggable terminal blocks,
- Install one VR... up to 8 poles plugs assembly and two VR... up to 15 poles assembly.

Ordering details

Description	Color	Type	Part Number	Pkg qty	Weight (1 pce)
9.4 mm 0.370 in spacing	Black	VR-ZD	1SNK900637R0000	50	6.5

Main technical data

Material specifications	Insulating material	Polyacetal	
	Flammability	HB	
	NF F 16 101		
Ambient temperature min/max	Service IEC 60068-2-1	-55 ... +110 °C	-67 ... +230 °F
	Storage	-55 ... +110 °C	-67 ... +230 °F
	Installing	-5 ... +40 °C	+23 ... +104 °F

All the main technical data provided are "manufacturer" values.

RoHS

Mounting instructions



Technical data valid for copper conductors only.

1SNK164009S0201



Index

Part Number classification

Part Number	Type	Page	Part Number	Type	Page	Part Number	Type	Page
1SNA007865R2600	FC2	110	1SNA173449R0700	BJH14-5	192	1SNA199393R2200	SCH6	192
1SNA103007R2300	PE	211	1SNA173451R2100	BJH14-10	192	1SNA199394R2300	INH3	192
1SNA103098R2600	SSB20	216	1SNA173452R2200	BJH18-2	192	1SNA199400R0600	FEHD1	147
1SNA103099R2700	SSB20T	216	1SNA173453R2300	BJH18-3	192	1SNA199411R1400	FJH501	153
1SNA113542R1000	PC5-2	253	1SNA173454R2400	BJH18-4	192	1SNA199412R1500	SCH8	153
1SNA113544R1200	PC5-10	253	1SNA173460R0600	BJH18-5	192	1SNA199551R2000	SCAD5	110
1SNA114205R2000	AD2.5	214	1SNA173461R2300	BJH18-10	192	1SNA205392R0700	HD4/9.F4.2	177
1SNA116538R1700	PC8-2	341	1SNA173523R1100	PC81-10	268	1SNA205396R0300	HD10/12.F5.2	181
1SNA116539R1000	PC8-3	341	1SNA173627R2100	EL6	111	1SNA205424R2700	FJHD40	181
1SNA116540R2500	PC8-4	341	1SNA174300R1700	PR3.Z2	310	1SNA205427R2200	INH1	177
1SNA116900R2700	BADH	117	1SNA174784R2000	BJS6-20	111	1SNA205428R0300	SCHD1	177
1SNA160487R2500	HD2.5/6.2G.2G.1	144	1SNA176278R1600	BJMI5-2	110	1SNA205429R0400	SCHD2	181
1SNA160563R0000	HD6/9.3G.2G	151	1SNA176279R1700	BJMI5-3G	110	1SNA205431R2600	FJHD32	177
1SNA160564R0100	HD6/9.2G.3G	152	1SNA176280R0500	BJMI5-4	110	1SNA205767R1600	DRF6	196
1SNA160606R1400	HD6/8.2G.2G.1	145	1SNA176281R2200	BJMI5-5	110	1SNA205768R2700	DRF8	197
1SNA160619R1000	HD6/8.2G.2G.2	146	1SNA176282R2300	BJMI5-10	110	1SNA205769R2000	DRF10	198
1SNA160621R0200	HD6/9.5G	150	1SNA176663R0000	BJMI6-2	111	1SNA205770R2500	DRF12	199
1SNA162309R1000	HD6/14.DG	158	1SNA176664R0100	BJMI6-3	111	1SNA205771R1200	DRF16	200
1SNA162315R2500	HD6/14.SF.2G.2G	155	1SNA176665R0200	BJMI6-4	111	1SNA205772R1300	BJS27-2	196
1SNA162971R2700	HD6/14.DH	157	1SNA176666R0300	BJMI6-5	111	1SNA205773R1400	BJS27-3	196
1SNA162972R2000	HD6/14.SDH	161	1SNA176667R0400	BJMI6-10	111	1SNA205774R1500	BJS32-2	197
1SNA162979R0700	HD16/14.FF5.20	195	1SNA176669R1600	BJMI8-2	112	1SNA205775R1600	BJS32-3	197
1SNA162988R2100	HD6/14.SDH.1	160	1SNA176670R1300	BJMI8-3	112	1SNA205776R1700	BJS42-2	198
1SNA162991R1400	HD16/14.FF5.21	194	1SNA176671R0000	BJMI8-4	112	1SNA205777R1000	BJS42-3	198
1SNA163043R2100	AL2	110	1SNA176672R0100	BJMI8-5	112	1SNA205778R2100	BJS51-2	199
1SNA163155R2600	REH3	190	1SNA176673R0200	BJMI8-10	112	1SNA205779R2200	BJS51-3	199
1SNA163156R2700	RTC	153	1SNA178430R0500	RCPEB	316	1SNA206053R0700	BJMI31.2	239
1SNA163261R0000	AL3	110	1SNA178431R2200	EPR1	316	1SNA206054R0000	BJMI31.3	239
1SNA163313R2400	PC8-10	303	1SNA178529R0400	PR50	311	1SNA206126R2500	BJMI36.2	240
1SNA163350R1500	PRH2R	313	1SNA178745R1400	CBM5	110	1SNA206223R0600	BJMI36.3	240
1SNA163468R0000	BJH131-10	179	1SNA178746R1500	CBM8	110	1SNA206680R1500	AJS9-BK	302
1SNA163475R2700	BJH17	182	1SNA178944R0400	OUPAD	110	1SNA206681R0200	AJS9-GN	302
1SNA163476R2000	BJH23-10	184	1SNA179371R1600	CN5	268	1SNA206682R0300	AJS9-GR	302
1SNA163479R0300	BJH311	186	1SNA179466R0600	OUMAD	110	1SNA206683R0400	AJS9-BL	302
1SNA163497R1600	PEFH	153	1SNA179726R0200	AJS9	300	1SNA206720R1400	AJS9-RD	302
1SNA163503R2400	BJH105	176	1SNA187312R1400	CPM	153	1SNA206721R0100	AL4-M3	300
1SNA163518R2200	RPED	153	1SNA190001R2000	D35/27.FF	196	1SNA206765R0000	AJS9-WH	302
1SNA164519R2400	BAR	211	1SNA190002R2100	D70/32.FF	197	1SNA206772R0000	AJS9-PR	302
1SNA164655R0400	BAH22	153	1SNA190003R2200	D120/42.FF	198	1SNA206782R0000	AJS9-BR	302
1SNA164800R0300	PR3.G2	311	1SNA190004R2300	D185/55.FF	199	1SNA230000R1200	RC55	110
1SNA167224R2700	BJS13-10	190	1SNA190005R2400	D300/55.FF	200	1SNA231000R0700	RC510	110
1SNA167489R2200	BAH21	176	1SNA190016R1600	CPUF35	196	1SNA232000R0000	RC65	111
1SNA167735R2700	VSJ6	144	1SNA190017R1700	CPUF70	197	1SNA233000R0100	RC610	111
1SNA167860R0100	FC4	112	1SNA190018R2000	CPUF120	198	1SNA234000R0200	RC810	112
1SNA168355R1300	BAH24	144	1SNA190019R2100	CPUF185	199	1SNA235106R2600	PAM43020	345
1SNA168356R1400	BJH8-10	145	1SNA190305R0500	HD2.5/6.3.2G.2G.1	166	1SNA235155R2600	PIB2-TT	316
1SNA168357R1500	BJH9-10	145	1SNA190312R2300	HD2.5/6.3.2G.2G.1.GG	163	1SNA235157R2000	PIB2-TT-YL	316
1SNA168456R0100	BJH8-2	145	1SNA190314R2500	HD2.5/6.3.GG1.2G.2G	164	1SNA235158R0100	RCPEAD-TT	316
1SNA168457R0200	BJH8-3	145	1SNA190316R2700	HD2.5/6.3.3G.3G.1	162	1SNA235159R0200	RCPEAD-TT-YL	316
1SNA168458R1300	BJH8-4	145	1SNA190468R0000	E4/6	211	1SNA235510R0800	M-W810PC	202
1SNA168459R1400	BJH8-5	145	1SNA190607R0400	E6/8	212	1SNA235511R0600	M-W610PC	201
1SNA168460R1100	BJH9-2	145	1SNA191296R1100	E10/16.S	216	1SNA235512R1000	M-W1010PC	203
1SNA168461R0600	BJH9-3	145	1SNA191302R2700	E10/16	213	1SNA238000R1600	RC1010	239
1SNA168462R0700	BJH9-4	145	1SNA193080R1200	FEE6-1	211	1SNA290451R0300	BJE762.2	119
1SNA168463R0000	BJH9-5	145	1SNA193085R0300	FEE8-2	212	1SNA290452R0400	BJE762.5	119
1SNA168481R2300	BJS61-2	144	1SNA193137R0300	FEMT1	214	1SNA290453R0500	BJE762.10	119
1SNA168482R2400	BJS61-3	144	1SNA193449R2400	FEE10-16	213	1SNA290454R0600	EIP	119
1SNA168483R2500	BJS61-4	144	1SNA193878R2200	FEH4	146	1SNA290455R0700	RB-12W7	119
1SNA168484R2600	BJS61-5	144	1SNA195212R1000	M6/8.STP	214	1SNA295011R1600	HD10/12.F5.3	179
1SNA168485R2700	BJS61-10	144	1SNA196792R1700	BNSTP1	214	1SNA295012R1700	HD16/14.FF5.21.3	192
1SNA168486R2000	BJH7-2	144	1SNA196853R1400	BNC62	115	1SNA295013R1000	HD16/14.FF5.20.3	193
1SNA168487R2100	BJH7-3	144	1SNA196854R1500	BNSV62	115	1SNA295014R1100	HD6/13.FF4	190
1SNA168490R0000	BJH7-10	144	1SNA196896R0000	SCAD	111	1SNA295015R1200	HD6/30.F12G	154
1SNA168497R2300	PC	213	1SNA196915R0200	BIE	216	1SNA295298R0300	HD4/10.F4.19	178
1SNA168500R1200	PR4	312	1SNA196924R0300	BNF52	116	1SNA295391R2000	HD4/9.F4	176
1SNA168672R1100	TGA8	268	1SNA196926R0500	BNCT82	116	1SNA295392R2100	HD4/9.F4.2	177
1SNA168673R1200	TGA8	268	1SNA196927R0600	BNSV82	116	1SNA295393R2200	HD4/9.FF4	189
1SNA168674R1300	TGA8	268	1SNA196998R1600	BNF652	115	1SNA295394R2300	HD10/12.F5	180
1SNA168675R1400	ANT	268	1SNA197312R1600	CPM	153	1SNA295395R2400	HD10/12.F5.1	181
1SNA168700R2200	PR5	312	1SNA198352R0700	FEH3	144	1SNA295396R2500	HD10/12.F5.2	181
1SNA168949R1700	FEHD2	162	1SNA198549R0500	FEH9	155	1SNA295397R2600	HD10/12.FF5	191
1SNA171018R2000	EXBN2	115	1SNA198692R2500	SCH3	144	1SNA295398R0700	HD35/16.F6.19	182
1SNA173220R0500	PR30	310	1SNA198729R0100	FEH8	158	1SNA295399R0000	HD35/16.F6.19.1	183
1SNA173241R0600	RDJ6	144	1SNA199025R1400	HD2.5/6.3.GG.1.2GG	165	1SNA295400R0600	HD70/22.F8.31	184
1SNA173438R2400	BJH14-2	192	1SNA199096R1400	HD2.5/6.3.GH.2G.H	167	1SNA295401R2300	HD70/22.F8.31.1	185
1SNA173439R2500	BJH14-3	192	1SNA199320R0400	COCF	128	1SNA295402R2400	HD70/22.F8.31.2	185
1SNA173441R2700	BJH14-4	192	1SNA199321R2100	COCE	119	1SNA295403R2500	HD120/30.F10.31.1	187

Index

Part Number classification

Part Number	Type	Page	Part Number	Type	Page	Part Number	Type	Page
1SNA295405R2700	HD185/36.F12.31.1	188	1SNA519200R0000	CS-RGW-S	201	1SNK506211R0000	ZS6-D1	287
1SNA295424R1100	FJHD40	178	1SNA519201R0000	CS-RGW-L	203	1SNK506212R0000	ZS6-D2-PE	288
1SNA295425R1200	FJHD50	191	1SNB041090R0510	MG-CPM-01 41090	201	1SNK506213R0000	ZS4-T3-R1	295
1SNA295426R1300	FJHD	178	1SNB041096R0810	MG-CPM-01 41096	202	1SNK506214R0000	ZS6-D1-RD	287
1SNA295427R1400	INHDI	176	1SNB041790R0512	MG-CPM 13 41790	19	1SNK506220R0000	ZS6-D2-BL	286
1SNA295428R2500	SCHD1	176	1SNB041791R0612	MG-CPM 13 41791	28	1SNK506230R0000	ZS6-D2-OR	286
1SNA295429R2600	SCHD2	178	1SNB043196R0012	MG-CPMFA 43196	93	1SNK506250R0000	ZS6-D1-PE	286
1SNA295430R2300	SCHD5	191	1SNB045194R1735	MG-TAR 45194	316	1SNK506260R0000	ZS6-D2-YL	286
1SNA295431R1000	FJHD32	176	1SNB045490R8530	MG-TAR 45490	316	1SNK506262R0000	ZS6-D2-RD	286
1SNA295448R0100	HD120/30.F10.31	186	1SNB046415R0615	MG-VYT 46415	332	1SNK506265R0000	ZS6-D2-WH	286
1SNA296351R0000	BAM2	110	1SNB046915R0615	MG-VYT 46915	332	1SNK506266R0000	ZS6-D2-BK	286
1SNA399726R0700	EPR2	316	1SNB049148R1735	MG-TAA 49148	316	1SNK506310R0000	ZS4-S-R1	255
1SNA399730R1700	D1.5/6.ADO.NF	111	1SNB049198R1735	MG-TAA 49198	316	1SNK506311R0000	ZS4-S-T2-R1	256
1SNA399736R0100	D2.5/8.ADO.NF	112	1SNB049448R8530	MG-TAA 49448	316	1SNK506312R0000	ZS4-S-T2.3-R1	256
1SNA399742R1700	D1.5/6.D2.ADO.NF	117	1SNB049498R8530	MG-TAA 49498	316	1SNK506313R0000	ZS4-SP-R1	262
1SNA399748R2500	D4/8.ADO.NF	114	1SNK140000R0000	MC512	19	1SNK506314R0000	ZS4-SP-T2-R1	263
1SNA399749R2600	D2.5/8.ADO.NF1	113	1SNK149999R0000	MC512PA	19	1SNK506315R0000	ZS6-S	257
1SNA399752R1100	D2.5/8.S.ADO.NF	116	1SNK150000R0000	MC612	22	1SNK506316R0000	ZS6-S-4S-T2	258
1SNA399787R0500	CPBP2	240	1SNK159999R0000	MC612PA	22	1SNK506320R0000	ZS4-S-R1-BL	255
1SNA399788R1600	CPBP1	239	1SNK160000R0000	MC812	28	1SNK506321R0000	ZS4-S-T2-R1-BL	256
1SNA399802R0500	FEMAD3	110	1SNK169999R0000	MC812PA	28	1SNK506322R0000	ZS6-S-BL	257
1SNA399803R0600	FED2AD2	117	1SNK505010R0000	ZS4	228	1SNK506330R0000	ZS4-S-R1-OR	255
1SNA399804R0700	FEDAD5	115	1SNK505020R0000	ZS4-BL	228	1SNK506331R0000	ZS4-S-T2-R1-OR	256
1SNA399916R2600	D1.5/6.ADO.D2.NF	118	1SNK505030R0000	ZS4-OR	228	1SNK506410R0000	ZS4-SF	274
1SNA399963R0500	HD6/24.DH	156	1SNK505060R0000	ZS4-YL	228	1SNK506411R0000	ZS4-SF-T2	275
1SNA399964R0600	HD6/24.DH	156	1SNK505061R0000	ZS4-GN	228	1SNK506412R0000	ZS4-SF-R1	276
1SNA400014R2700	ES8-CG	215	1SNK505062R0000	ZS4-RD	228	1SNK506413R0000	ZS4-SF-R2	277
1SNA400015R2000	ES8-CG	215	1SNK505063R0000	ZS4-PR	228	1SNK506414R0000	ZS4-S-R2	280
1SNA400018R0300	FECPE.2ADO	121	1SNK505064R0000	ZS4-BR	228	1SNK506415R0000	ZS4-SF-R3	276
1SNA400019R0400	FECPE.ADO	119	1SNK505065R0000	ZS4-WH	228	1SNK506416R0000	ZS4-SF-R4	277
1SNA400061R0600	D2.5/7.ADO-CPE.NF	122	1SNK505066R0000	ZS4-BK	228	1SNK508010R0000	ZS10	232
1SNA400062R0700	D2.5/7.2ADO-CPE.NF	123	1SNK505150R0000	ZS4-PE	228	1SNK508011R0000	ZS10-R1	300
1SNA400063R0000	VRADO.CPE7	119	1SNK505210R0000	ZS4-D2	284	1SNK508013R0000	ZS4-R1	272
1SNA400083R2500	D1.5/6.S.ADO.NF	115	1SNK505211R0000	ZS4-D1	285	1SNK508020R0000	ZS10-BL	232
1SNA400142R0400	BNSV62-1	115	1SNK505212R0000	ZS4-T3	294	1SNK508030R0000	ZS10-OR	232
1SNA400153R0700	D1.5/7.ADO-CPE.NF	119	1SNK505214R0000	ZS4-D-CH-UD	296	1SNK508060R0000	ZS10-YL	232
1SNA400154R0000	D1.5/7.2ADO-CPE.NF	121	1SNK505215R0000	ZS4-D-CH-DU	297	1SNK508061R0000	ZS10-GN	232
1SNA400156R0200	D2.5/7.ADO-CPE.NF1	120	1SNK505220R0000	ZS4-D2-BL	284	1SNK508062R0000	ZS10-RD	232
1SNA400240R2200	D4/7.ADO-CPE.NF	124	1SNK505230R0000	ZS4-D2-OR	284	1SNK508063R0000	ZS10-PR	232
1SNA400241R1700	D4/7.2ADO-CPE.NF	125	1SNK505310R0000	ZS4-S	253	1SNK508064R0000	ZS10-BR	232
1SNA400315R0100	D1.5/5.ADO.NF	110	1SNK505311R0000	ZS4-S-T2	254	1SNK508065R0000	ZS10-WH	232
1SNA400703R1700	D2.5/7.2CPE	126	1SNK505312R0000	ZS4-S-T2.3	254	1SNK508066R0000	ZS10-BK	232
1SNA400704R1000	D2.5/7.CPE.CPE	127	1SNK505313R0000	ZS4-SP	260	1SNK508150R0000	ZS10-PE	232
1SNA400708R2400	FECPE	126	1SNK505314R0000	ZS4-SP-T2	261	1SNK508151R0000	ZS10-PE-R1	301
1SNA400711R0600	PC8-R1	301	1SNK505315R0000	ZS4-D2-S	290	1SNK508310R0000	ZS10-ST	302
1SNA400712R0700	PC8-R2	303	1SNK505316R0000	ZS4-D2-S-T2	291	1SNK508311R0000	ZS10-ST-T4	300
1SNA400713R0000	PC8-R3	303	1SNK505320R0000	ZS4-S-BL	253	1SNK508312R0000	ZS10-ST-1	300
1SNA400724R0300	PC8-R4	303	1SNK505321R0000	ZS4-S-T2-BL	254	1SNK508315R0000	ZS10-S	259
1SNA400766R1500	HD6/7.5G	147	1SNK505330R0000	ZS4-S-OR	253	1SNK508316R0000	ZS10-SP	264
1SNA400767R1600	HD6/7.3G.2G	148	1SNK505331R0000	ZS4-S-T2-OR	254	1SNK508320R0000	ZS10-S-BL	259
1SNA400768R2700	HD6/7.2G.3G	149	1SNK505910R0000	ES4	228	1SNK508410R0000	ZS4-SF1	268
1SNA400782R0000	HD6/22.F12G	153	1SNK505911R0000	ES6-4S	231	1SNK508411R0000	ZS4-SF1-T2	269
1SNA400799R0000	FESDH	159	1SNK505912R0000	ES6-3S	230	1SNK508412R0000	ZS4-SF1-R1	270
1SNA400800R0000	HD6/9.SDH.1	159	1SNK505960R0000	ES4-D2	284	1SNK508413R0000	ZS4-SF1-R2	271
1SNA400842R0000	PC8-R5	303	1SNK505961R0000	ES4-T3	294	1SNK508414R0000	ZS4-SF1-R3	270
1SNA400843R0000	PC8-R6	303	1SNK506010R0000	ZS6	229	1SNK508415R0000	ZS4-SF1-R4	271
1SNA400849R0000	PC8-R7	303	1SNK506011R0000	ZS6-3S	230	1SNK508416R0000	ZS4-S-R3	273
1SNA400850R0000	PC8-R8	303	1SNK506012R0000	ZS6-4S	231	1SNK508417R0000	ZS10-S-R2	283
1SNA510003R0000	RGW2.5-V0	201	1SNK506013R0000	ZS4-R2	278	1SNK508418R0000	ZS10-SF	281
1SNA510005R0000	RGW25-M5-V0	203	1SNK506020R0000	ZS6-BL	229	1SNK508419R0000	ZS4-S-R3-T2	273
1SNA510006R0000	RGW25-M6-V0	204	1SNK506021R0000	ZS6-3S-BL	230	1SNK508421R0000	ZS10-SF-R1	282
1SNA510024R0000	RGW6-V0	202	1SNK506022R0000	ZS6-4S-BL	231	1SNK508422R0000	ZS10-SF-R3	282
1SNA511003R0500	RGW2.5-PE-V0	201	1SNK506030R0000	ZS6-OR	229	1SNK508423R0000	ZS4-D2-SF1-R1	293
1SNA511024R0500	RGW6-PE-V0	202	1SNK506060R0000	ZS6-YL	229	1SNK508424R0000	ZS4-D2-SF1-R3	293
1SNA519003R0000	E-RGW2.5	201	1SNK506061R0000	ZS6-GN	229	1SNK508425R0000	ZS4-D2-SF1	292
1SNA519004R0000	E-RGW6	202	1SNK506062R0000	ZS6-RD	229	1SNK508430R0000	ZS4-SF1-OR	268
1SNA519005R0000	E-RGW25	203	1SNK506063R0000	ZS6-PR	229	1SNK508910R0000	ES10-ST	300
1SNA519103R0200	PC-RG2.5-2	201	1SNK506064R0000	ZS6-BR	229	1SNK508911R0000	ES4-D2-SF1	292
1SNA519103R0300	PC-RG2.5-3	201	1SNK506065R0000	ZS6-WH	229	1SNK508960R0000	ES4-SF	268
1SNA519103R0400	PC-RG2.5-4	201	1SNK506066R0000	ZS6-BK	229	1SNK510010R0000	ZS16	233
1SNA519103R1000	PC-RG2.5-10	201	1SNK506067R0000	ZS6-3S-YL	230	1SNK510020R0000	ZS16-BL	233
1SNA519104R0200	PC-RG6-2	202	1SNK506068R0000	ZS6-4S-YL	231	1SNK510030R0000	ZS16-OR	233
1SNA519104R0300	PC-RG6-3	202	1SNK506150R0000	ZS6-PE	229	1SNK510150R0000	ZS16-PE	233
1SNA519104R0400	PC-RG6-4	202	1SNK506151R0000	ZS6-3S-PE	230	1SNK512010R0000	ZS25	234
1SNA519104R0700	PC-RG6-7	202	1SNK506152R0000	ZS6-4S-PE	231	1SNK512020R0000	ZS25-BL	234
1SNA519104R1000	PC-RG6-10	202	1SNK506153R0000	ZS4-PE-R2	279	1SNK512060R0000	ZS25-YL	234
1SNA519106R0200	PC-RG25-2	203	1SNK506210R0000	ZS6-D2	286	1SNK512150R0000	ZS25-PE	234



Index

Part Number classification

Part Number	Type	Page	Part Number	Type	Page	Part Number	Type	Page
1SNK516010R0000	ZS35	235	1SNK705912R0000	EK2.5-4P	21	1SNK805715R0000	CDS4-E	98
1SNK516011R0000	ZS50	236	1SNK705913R0000	EK2.5-S-4P	48	1SNK805738R0000	CDK2.5-J	94
1SNK516020R0000	ZS35-BL	235	1SNK705960R0000	EK2.5-D2	54	1SNK805739R0000	CDK2.5-J-E	94
1SNK516021R0000	ZS50-BL	236	1SNK705961R0000	EK2.5-T3	58	1SNK805740R0000	CDK2.5-2P-J	95
1SNK516030R0000	ZS35-OR	235	1SNK706010R0000	ZK4	22	1SNK805741R0000	CDK2.5-2P-J-E	95
1SNK516060R0000	ZS50-YL	236	1SNK706011R0000	ZK4-3P	23	1SNK805742R0000	CDK2.5-BL	83
1SNK516063R0000	ZS50-RD	236	1SNK706012R0000	ZK4-4P	24	1SNK805743R0000	CDK2.5-BL-E	83
1SNK516064R0000	ZS50-BK	236	1SNK706020R0000	ZK4-BL	22	1SNK805744R0000	CDK2.5-J-BL	94
1SNK516150R0000	ZS35-PE	235	1SNK706021R0000	ZK4-3P-BL	23	1SNK805745R0000	CDK2.5-J-BL-E	94
1SNK516151R0000	ZS50-PE	236	1SNK706022R0000	ZK4-4P-BL	24	1SNK805746R0000	CDK2.5-2P-J-BL	95
1SNK516170R0000	ZS35-PEN	249	1SNK706030R0000	ZK4-OR	22	1SNK805747R0000	CDK2.5-2P-J-BL-E	95
1SNK522010R0000	ZS70	237	1SNK706031R0000	ZK4-3P-OR	23	1SNK805748R0000	CDK2.5-J-PE	94
1SNK522020R0000	ZS70-BL	237	1SNK706032R0000	ZK4-4P-OR	24	1SNK805749R0000	CDK2.5-J-PE-E	94
1SNK522060R0000	ZS70-YL	237	1SNK706060R0000	ZK4-YL	22	1SNK805750R0000	CDK2.5-PE	82
1SNK522150R0000	ZS70-PE	237	1SNK706062R0000	ZK4-RD	22	1SNK805751R0000	CDK2.5-2P-J-PE	95
1SNK526010R0000	ZS95	238	1SNK706066R0000	ZK4-BK	22	1SNK805752R0000	CDK2.5-2P-J-PE-E	95
1SNK526020R0000	ZS95-BL	238	1SNK706150R0000	ZK4-PE	22	1SNK805753R0000	CDK2.5-PE-E	82
1SNK526060R0000	ZS95-YL	238	1SNK706151R0000	ZK4-PE-3P	23	1SNK805910R0000	EDK2.5-22	85
1SNK526150R0000	ZS95-PE	238	1SNK706152R0000	ZK4-PE-4P	24	1SNK805911R0000	EDS4-22	98
1SNK531010R0000	ZS150	239	1SNK706310R0000	ZK2.5-S-R1	49	1SNK805913R0000	EDK2.5-D	89
1SNK531020R0000	ZS150-BL	239	1SNK706410R0000	ZK2.5-SF	49	1SNK805914R0000	EDK2.5-21	84
1SNK531060R0000	ZS150-YL	239	1SNK706411R0000	ZK2.5-SF-R1	53	1SNK805915R0000	EDK2.5-11	80
1SNK536010R0000	ZS240	240	1SNK706412R0000	ZK2.5-SF-R3	53	1SNK805917R0000	ED2.5-22	81
1SNK536020R0000	ZS240-BL	240	1SNK708010R0000	ZK6	25	1SNK806010R0000	ZDK4-22	86
1SNK536060R0000	ZS240-YL	240	1SNK708011R0000	ZK6-3P	26	1SNK806013R0000	ZDS4-22-R1	100
1SNK705010R0000	ZK2.5	19	1SNK708020R0000	ZK6-BL	25	1SNK806712R0000	CDK4	86
1SNK705011R0000	ZK2.5-3P	20	1SNK708021R0000	ZK6-3P-BL	26	1SNK806713R0000	CDK4-E	86
1SNK705012R0000	ZK2.5-4P	21	1SNK708030R0000	ZK6-OR	25	1SNK806714R0000	CDS4-R1	100
1SNK705020R0000	ZK2.5-BL	19	1SNK708031R0000	ZK6-3P-OR	26	1SNK900001R0000	BAM4	201
1SNK705021R0000	ZK2.5-3P-BL	20	1SNK708060R0000	ZK6-YL	25	1SNK900002R0000	BAZ1	28
1SNK705022R0000	ZK2.5-4P-BL	21	1SNK708062R0000	ZK6-RD	25	1SNK900101R0000	CS	228
1SNK705030R0000	ZK2.5-OR	19	1SNK708066R0000	ZK6-BK	25	1SNK900102R0000	BAZH1	203
1SNK705031R0000	ZK2.5-3P-OR	20	1SNK708150R0000	ZK6-PE	25	1SNK900103R0000	CS-R1	228
1SNK705032R0000	ZK2.5-4P-OR	21	1SNK708151R0000	ZK6-PE-3P	26	1SNK900104R0000	ES-TC8	25
1SNK705060R0000	ZK2.5-YL	19	1SNK708911R0000	EK6-3P	26	1SNK900105R0000	ES-TC6	22
1SNK705061R0000	ZK2.5-GN	19	1SNK710010R0000	ZK10	27	1SNK900106R0000	CS-R2	19
1SNK705062R0000	ZK2.5-RD	19	1SNK710011R0000	ZK10-3P	29	1SNK900107R0000	CS-R3	28
1SNK705065R0000	ZK2.5-WH	19	1SNK710020R0000	ZK10-BL	27	1SNK900200R0000	TC5	19
1SNK705066R0000	ZK2.5-BK	19	1SNK710021R0000	ZK10-3P-BL	29	1SNK900201R0000	TC5-R1	19
1SNK705067R0000	ZK2.5-3P-YL	20	1SNK710030R0000	ZK10-OR	27	1SNK900203R0000	TP2	28
1SNK705068R0000	ZK2.5-3P-GN	20	1SNK710063R0000	ZK10-PV	28	1SNK900205R0000	TP4	28
1SNK705069R0000	ZK2.5-3P-RD	20	1SNK710064R0000	ZK10-3P-PV	30	1SNK900401R0000	PG5	50
1SNK705072R0000	ZK2.5-3P-WH	20	1SNK710065R0000	ZK10-PV-BL	28	1SNK900402R0000	PG5-R1	50
1SNK705073R0000	ZK2.5-3P-BK	20	1SNK710067R0000	ZK10-3P-PV-BL	30	1SNK900403R0000	PG5-R2	326
1SNK705074R0000	ZK2.5-4P-YL	21	1SNK710150R0000	ZK10-PE	28	1SNK900600R0000	SHBS	228
1SNK705075R0000	ZK2.5-4P-GN	21	1SNK710151R0000	ZK10-PE-3P	30	1SNK900601R0000	SHBP	19
1SNK705076R0000	ZK2.5-4P-RD	21	1SNK710910R0000	EK10	27	1SNK900602R0000	SHB	54
1SNK705079R0000	ZK2.5-4P-WH	21	1SNK710911R0000	EK10-3P	29	1SNK900603R0000	JB85-3	19
1SNK705080R0000	ZK2.5-4P-BK	21	1SNK712010R0000	ZK16	31	1SNK900604R0000	CO	303
1SNK705150R0000	ZK2.5-PE	19	1SNK712011R0000	ZK16-3P	33	1SNK900605R0000	LH	314
1SNK705151R0000	ZK2.5-PE-3P	20	1SNK712020R0000	ZK16-BL	31	1SNK900606R0000	LH-J	54
1SNK705152R0000	ZK2.5-PE-4P	21	1SNK712021R0000	ZK16-3P-BL	33	1SNK900607R0000	LH-R1	314
1SNK705210R0000	ZK2.5-D2	54	1SNK712063R0000	ZK16-PV	32	1SNK900611R0000	UMH	28
1SNK705211R0000	ZK2.5-D1	55	1SNK712064R0000	ZK16-3P-PV	34	1SNK900618R0000	PL5	228
1SNK705212R0000	ZK2.5-D2-PE	56	1SNK712065R0000	ZK16-PV-BL	32	1SNK900619R0000	PL6	229
1SNK705213R0000	ZK2.5-D-CH-UD	65	1SNK712067R0000	ZK16-3P-PV-BL	34	1SNK900620R0000	PL8	232
1SNK705214R0000	ZK2.5-D-CH-DU	66	1SNK712150R0000	ZK16-PE	32	1SNK900621R0000	PL10	233
1SNK705219R0000	ZK2.5-D-CH2-DU-RL	67	1SNK712151R0000	ZK16-PE-3P	34	1SNK900622R0000	PL16	235
1SNK705220R0000	ZK2.5-D2-BL	54	1SNK805010R0000	ZDK2.5-22	85	1SNK900624R0000	KCO	303
1SNK705250R0000	ZK2.5-D1-PE	54	1SNK805013R0000	ZDS4-22	98	1SNK900625R0000	PT-3	325
1SNK705310R0000	ZK2.5-S	47	1SNK805014R0000	ZDK2.5-21	84	1SNK900627R0000	RILS	334
1SNK705311R0000	ZK2.5-SP	50	1SNK805015R0000	ZDK2.5-11	83	1SNK900630R0000	MCLH	316
1SNK705312R0000	ZK2.5-S-4P	48	1SNK805016R0000	ZD2.5-11	80	1SNK900631R0000	MCLH-R1	316
1SNK705313R0000	ZK2.5-SP-4P	51	1SNK805017R0000	ZD2.5-22	81	1SNK900633R0000	MCLH-YL	316
1SNK705320R0000	ZK2.5-S-BL	47	1SNK805020R0000	ZDK2.5-22-BL	85	1SNK900634R0000	MCLH-R1-YL	316
1SNK705321R0000	ZK2.5-S-4P-BL	48	1SNK805025R0000	ZDK2.5-11-BL	83	1SNK900636R0000	COP-ZD	80
1SNK705330R0000	ZK2.5-S-OR	47	1SNK805150R0000	ZDK2.5-11-PE	87	1SNK900637R0000	VR-ZD	93
1SNK705331R0000	ZK2.5-S-4P-OR	48	1SNK805152R0000	ZDK2.5-22-PE	88	1SNK900640R0000	TO3.5-50	328
1SNK705510R0000	ZK2.5-T3	58	1SNK805156R0000	ZD2.5-22-PE	82	1SNK900641R0000	TO4-100	328
1SNK705511R0000	ZK2.5-T1	59	1SNK805212R0000	ZDK2.5-D2-PE	91	1SNK900642R0000	TO5.5-125	328
1SNK705512R0000	ZK2.5-L-L-PE	60	1SNK805213R0000	ZDK2.5-D2	89	1SNK900643R0000	TO6.5-150	328
1SNK705513R0000	ZK2.5-L-N-PE	61	1SNK805214R0000	ZDK2.5-D1	90	1SNK900644R0000	TO3.5-100-INS	328
1SNK705550R0000	ZK2.5-T1-PE	58	1SNK805223R0000	ZDK2.5-D2-BL	89	1SNK900650R0000	PS-3	328
1SNK705710R0000	ZK2.5-CH-4P-LR	63	1SNK805250R0000	ZDK2.5-D1-PE	92	1SNK900652R0000	SC-JB8-2	300
1SNK705711R0000	ZK2.5-CH-4P-RL	64	1SNK805712R0000	CDK2.5	80	1SNK900653R0000	SC-JB8-3	304
1SNK705910R0000	EK2.5	19	1SNK805713R0000	CDK2.5-E	80	1SNK900654R0000	SC-JB8-4	304
1SNK705911R0000	EK2.5-3P	20	1SNK805714R0000	CDS4	98	1SNK900655R0000	SC-JB8-5	346

Index

Part Number classification

Part Number	Type	Page	Part Number	Type	Page
1SNK900657R0000	SC-JB8-3-OR	346	1SSS267210R9800	FIC F.ADO.T2.B.10PNF	132
1SNK900658R0000	SC-JB8-4-OR	346	1SSS267216R9800	FIC F.ADO.T2.B.16PNF	132
1SNK900659R0000	TO3.5-50-A	328	1SSS276204R8800	FIC F.ADO.T3.4PNF	133
1SNK900660R0000	PT-ZD	93	1SSS276205R8800	FIC F.ADO.T3.5PNF	133
1SNK905302R0000	JB5-2	19	1SSS277202R8800	FIC F.ADO.T3-.2PNF	130
1SNK905303R0000	JB5-3	19	1SSS277203R8800	FIC F.ADO.T3-.3PNF	130
1SNK905304R0000	JB5-4	19	1SSS277204R8800	FIC F.ADO.T3-.4PNF	130
1SNK905305R0000	JB5-5	19	1SSS277205R8800	FIC F.ADO.T3-.5PNF	130
1SNK905310R0000	JB5-10	19	1SSS277206R8800	FIC F.ADO.T3-.6PNF	130
1SNK905350R0000	JB5-50	19	1SSS299253R2800	PT1	128
1SNK906302R0000	JB6-2	22	1SSS299254R2800	PT2	128
1SNK906303R0000	JB6-3	22	1SSS366202R4100	FIC M.ADO.T1.FI.2PNF	134
1SNK906304R0000	JB6-4	22	1SSS366203R4100	FIC M.ADO.T1.FI.3PNF	134
1SNK906305R0000	JB6-5	22	1SSS366204R4100	FIC M.ADO.T1.FI.4PNF	134
1SNK906310R0000	JB6-10	22	1SSS366205R4100	FIC M.ADO.T1.FI.5PNF	134
1SNK906350R0000	JB6-50	22	1SSS366206R4100	FIC M.ADO.T1.FI.6PNF	134
1SNK908302R0000	JB8-2	25	1SSS366208R4100	FIC M.ADO.T1.FI.8PNF	134
1SNK908303R0000	JB8-3	25	1SSS366210R4100	FIC M.ADO.T1.FI.10PNF	134
1SNK908304R0000	JB8-4	25	1SSS367202R4100	FIC M.ADO.T2.FI.2PNF	135
1SNK908305R0000	JB8-5	25	1SSS367203R4100	FIC M.ADO.T2.FI.3PNF	135
1SNK908310R0000	JB8-10	25	1SSS367204R4100	FIC M.ADO.T2.FI.4PNF	135
1SNK908902R0000	JB8-2-R1	302	1SSS367205R4100	FIC M.ADO.T2.FI.5PNF	135
1SNK908903R0000	JB8-3-R1	302	1SSS367206R4100	FIC M.ADO.T2.FI.6PNF	135
1SNK908904R0000	JB8-4-R1	302	1SSS367208R4100	FIC M.ADO.T2.FI.8PNF	135
1SNK908905R0000	JB8-5-R1	302	1SSS367210R4100	FIC M.ADO.T2.FI.10PNF	135
1SNK908910R0000	JB8-10-R1	302			
1SNK910302R0000	JB10-2	27			
1SNK910303R0000	JB10-3	27			
1SNK910304R0000	JB10-4	27			
1SNK910305R0000	JB10-5	27			
1SNK910310R0000	JB10-10	27			
1SNK912302R0000	JB12-2	28			
1SNK912303R0000	JB12-3	28			
1SNK912305R0000	JB12-5	28			
1SNK916302R0000	JB16-2	235			
1SNK916303R0000	JB16-3	235			
1SNK916304R0000	JB16-4	235			
1SNK916305R0000	JB16-5	235			
1SNK916310R0000	JB16-10	235			
1SNK922302R0000	JB22-2	237			
1SNK922303R0000	JB22-3	237			
1SNK922305R0000	JB22-5	237			
1SNK922310R0000	JB22-10	237			
1SNK926302R0000	JB26-2	238			
1SNK926303R0000	JB26-3	238			
1SNK926305R0000	JB26-5	238			
1SNK926310R0000	JB26-10	238			
1SSS266202R8800	FIC F.ADO.T1.2PNF	128			
1SSS266202R9800	FIC F.ADO.T1.B.2PNF	129			
1SSS266203R8800	FIC F.ADO.T1.3PNF	128			
1SSS266203R9800	FIC F.ADO.T1.B.3PNF	129			
1SSS266204R8800	FIC F.ADO.T1.4PNF	128			
1SSS266204R9800	FIC F.ADO.T1.B.4PNF	129			
1SSS266205R8800	FIC F.ADO.T1.5PNF	128			
1SSS266205R9800	FIC F.ADO.T1.B.5PNF	129			
1SSS266206R8800	FIC F.ADO.T1.6PNF	128			
1SSS266206R9800	FIC F.ADO.T1.B.6PNF	129			
1SSS266207R8800	FIC F.ADO.T1.7PNF	128			
1SSS266208R8800	FIC F.ADO.T1.8PNF	128			
1SSS266208R9800	FIC F.ADO.T1.B.8PNF	129			
1SSS266209R8800	FIC F.ADO.T1.9PNF	128			
1SSS266210R8800	FIC F.ADO.T1.10PNF	128			
1SSS266210R9800	FIC F.ADO.T1.B.10PNF	129			
1SSS267202R8800	FIC F.ADO.T2.2PNF	131			
1SSS267202R9800	FIC F.ADO.T2.B.2PNF	132			
1SSS267203R8800	FIC F.ADO.T2.3PNF	131			
1SSS267203R9800	FIC F.ADO.T2.B.3PNF	132			
1SSS267204R8800	FIC F.ADO.T2.4PNF	131			
1SSS267204R9800	FIC F.ADO.T2.B.4PNF	132			
1SSS267205R8800	FIC F.ADO.T2.5PNF	131			
1SSS267205R9800	FIC F.ADO.T2.B.5PNF	132			
1SSS267206R8800	FIC F.ADO.T2.6PNF	131			
1SSS267206R9800	FIC F.ADO.T2.B.6PNF	132			
1SSS267207R8800	FIC F.ADO.T2.7PNF	131			
1SSS267208R8800	FIC F.ADO.T2.8PNF	131			
1SSS267208R9800	FIC F.ADO.T2.B.8PNF	132			
1SSS267210R8800	FIC F.ADO.T2.10PNF	131			

Index

Type classification

Type	Part Number	Page	Type	Part Number	Page	Type	Part Number	Page
AD2.5	1SNA114205R2000	214	BJS32-2	1SNA205774R1500	197	D2.5/7.CPE.CPE	1SNA400704R1000	127
AJS9	1SNA179726R0200	300	BJS32-3	1SNA205775R1600	197	D2.5/8.ADO.NF	1SNA399736R0100	112
AJS9-BK	1SNA206680R1500	302	BJS42-2	1SNA205776R1700	198	D2.5/8.ADO.NF1	1SNA399749R2600	113
AJS9-BL	1SNA206683R0400	302	BJS42-3	1SNA205777R1000	198	D2.5/8.S.ADO.NF	1SNA399752R1100	116
AJS9-BR	1SNA206782R0000	302	BJS51-2	1SNA205778R2100	199	D300/55.FF	1SNA190005R2400	200
AJS9-GN	1SNA206681R0200	302	BJS51-3	1SNA205779R2200	199	D35/27.FF	1SNA190001R2000	196
AJS9-GR	1SNA206682R0300	302	BJS61-10	1SNA168485R2700	144	D4/7.2ADO.CPE.NF	1SNA400241R1700	125
AJS9-PR	1SNA206772R0000	302	BJS61-2	1SNA168481R2300	144	D4/7.ADO.CPE.NF	1SNA400240R2200	124
AJS9-RD	1SNA206720R1400	302	BJS61-3	1SNA168482R2400	144	D4/8.ADO.NF	1SNA399748R2500	114
AJS9-WH	1SNA206765R0000	302	BJS61-4	1SNA168483R2500	144	D70/32.FF	1SNA190002R2100	197
AL2	1SNA163043R2100	110	BJS61-5	1SNA168484R2600	144	DRF10	1SNA205769R2000	198
AL3	1SNA163261R0000	110	BJS6-20	1SNA174784R2000	111	DRF12	1SNA205770R2500	199
AL4-M3	1SNA206721R0100	300	BNCE2	1SNA196853R1400	115	DRF16	1SNA205771R1200	200
ANT	1SNA168675R1400	268	BNCT82	1SNA196926R0500	116	DRF6	1SNA205767R1600	196
BADH	1SNA116900R2700	117	BNF52	1SNA196924R0300	116	DRF8	1SNA205768R2700	197
BAH21	1SNA167489R2200	176	BNF652	1SNA196998R1600	115	E10/16	1SNA191302R2700	213
BAH22	1SNA164655R0400	153	BNSTP1	1SNA196792R1700	214	E10/16.S	1SNA191296R1100	216
BAH24	1SNA168355R1300	144	BNSV62	1SNA196854R1500	115	E4/6	1SNA190468R0000	211
BAM2	1SNA296351R0000	110	BNSV62-1	1SNA400142R0400	115	E6/8	1SNA190607R0400	212
BAM4	1SNK900001R0000	201	BNSV82	1SNA196927R0600	116	ED2.5-22	1SNK805917R0000	81
BAR	1SNA164519R2400	211	CBM5	1SNA178745R1400	110	EDK2.5-11	1SNK805915R0000	80
BAZ1	1SNK900002R0000	28	CBM8	1SNA178746R1500	110	EDK2.5-21	1SNK805914R0000	84
BAZH1	1SNK900102R0000	203	CDK2.5	1SNK805712R0000	80	EDK2.5-22	1SNK805910R0000	85
BIE	1SNA196915R0200	216	CDK2.5-2P-J	1SNK805740R0000	95	EDK2.5-D	1SNK805913R0000	89
BJE762.10	1SNA290453R0500	119	CDK2.5-2P-J-BL	1SNK805746R0000	95	EDS4-22	1SNK805911R0000	98
BJE762.2	1SNA290451R0300	119	CDK2.5-2P-J-BL-E	1SNK805747R0000	95	EIP	1SNA290454R0600	119
BJE762.5	1SNA290452R0400	119	CDK2.5-2P-J-E	1SNK805741R0000	95	EK10	1SNK710910R0000	27
BJH105	1SNA163503R2400	176	CDK2.5-2P-J-PE	1SNK805751R0000	95	EK10-3P	1SNK710911R0000	29
BJH131-10	1SNA163468R0000	179	CDK2.5-2P-J-PE-E	1SNK805752R0000	95	EK2.5	1SNK705910R0000	19
BJH14-10	1SNA173451R2100	192	CDK2.5-BL	1SNK805742R0000	83	EK2.5-3P	1SNK705911R0000	20
BJH14-2	1SNA173438R2400	192	CDK2.5-BL-E	1SNK805743R0000	83	EK2.5-4P	1SNK705912R0000	21
BJH14-3	1SNA173439R2500	192	CDK2.5-E	1SNK805713R0000	80	EK2.5-D2	1SNK705960R0000	54
BJH14-4	1SNA173441R2700	192	CDK2.5-J	1SNK805738R0000	94	EK2.5-S-4P	1SNK705913R0000	48
BJH14-5	1SNA173449R0700	192	CDK2.5-J-BL	1SNK805744R0000	94	EK2.5-T3	1SNK705961R0000	58
BJH17	1SNA163475R2700	182	CDK2.5-J-BL-E	1SNK805745R0000	94	EK6-3P	1SNK708911R0000	26
BJH18-10	1SNA173461R2300	192	CDK2.5-J-E	1SNK805739R0000	94	EL6	1SNA173627R2100	111
BJH18-2	1SNA173452R2200	192	CDK2.5-J-PE	1SNK805748R0000	94	EPR1	1SNA178431R2200	316
BJH18-3	1SNA173453R2300	192	CDK2.5-J-PE-E	1SNK805749R0000	94	EPR2	1SNA399726R0700	316
BJH18-4	1SNA173454R2400	192	CDK2.5-PE	1SNK805750R0000	82	E-RGW2.5	1SNA519003R0000	201
BJH18-5	1SNA173460R0600	192	CDK2.5-PE-E	1SNK805753R0000	82	E-RGW25	1SNA519005R0000	203
BJH23-10	1SNA163476R2000	184	CDK4	1SNK806712R0000	86	E-RGW6	1SNA519004R0000	202
BJH311	1SNA163479R0300	186	CDK4-E	1SNK806713R0000	86	ES10-ST	1SNK508910R0000	300
BJH7-10	1SNA168490R0000	144	CDS4	1SNK805714R0000	98	ES4	1SNK505910R0000	228
BJH7-2	1SNA168486R2000	144	CDS4-E	1SNK805715R0000	98	ES4-D2	1SNK505960R0000	284
BJH7-3	1SNA168487R2100	144	CDS4-R1	1SNK806714R0000	100	ES4-D2-SF1	1SNK508911R0000	292
BJH8-10	1SNA168356R1400	145	ON5	1SNA179371R1600	268	ES4-SF	1SNK508960R0000	268
BJH8-2	1SNA168456R0100	145	CO	1SNK900604R0000	303	ES4-T3	1SNK505961R0000	294
BJH8-3	1SNA168457R0200	145	COCE	1SNA199321R2100	119	ES6-3S	1SNK505912R0000	230
BJH8-4	1SNA168458R1300	145	COCF	1SNA199320R0400	128	ES6-4S	1SNK505911R0000	231
BJH8-5	1SNA168459R1400	145	COP-ZD	1SNK900636R0000	80	ES8-CG	1SNA400014R2700	215
BJH9-10	1SNA168357R1500	145	CPBP1	1SNA399788R1600	239		1SNA400015R2000	215
BJH9-2	1SNA168460R1100	145	CPBP2	1SNA399787R0500	240	ES-TC6	1SNK900105R0000	22
BJH9-3	1SNA168461R0600	145	CPM	1SNA187312R1400	153	ES-TC8	1SNK900104R0000	25
BJH9-4	1SNA168462R0700	145	CPUF120	1SNA190018R2000	198	EXBN2	1SNA171018R2000	115
BJH9-5	1SNA168463R0000	145	CPUF185	1SNA190019R2100	199	FC2	1SNA007865R2600	110
BJMI31.2	1SNA206053R0700	239	CPUF35	1SNA190016R1600	196	FC4	1SNA167860R0100	112
BJMI31.3	1SNA206054R0000	239	CPUF70	1SNA190017R1700	197	FE0PE	1SNA400708R2400	126
BJMI36.2	1SNA206126R2500	240	CS	1SNK900101R0000	228	FE0PE.2ADO	1SNA400018R0300	121
BJMI36.3	1SNA206223R0600	240	CS-R1	1SNK900103R0000	228	FE0PE.ADO	1SNA400019R0400	119
BJMI5-10	1SNA176282R2300	110	CS-R2	1SNK900106R0000	19	FED2AD2	1SNA399803R0600	117
BJMI5-2	1SNA176278R1600	110	CS-R3	1SNK900107R0000	28	FEDAD5	1SNA399804R0700	115
BJMI5-3	1SNA176279R1700	110	CS-RGW-L	1SNA519201R0000	203	FEE10-16	1SNA193449R2400	213
BJMI5-4	1SNA176280R0500	110	CS-RGW-S	1SNA519200R0000	201	FEE6-1	1SNA193080R1200	211
BJMI5-5	1SNA176281R2200	110	D1.5/5.ADO.NF	1SNA400315R0100	110	FEE8-2	1SNA193085R0300	212
BJMI6-10	1SNA176667R0400	111	D1.5/6.ADO.D2.NF	1SNA399916R2600	118	FEH3	1SNA198352R0700	144
BJMI6-2	1SNA176663R0000	111	D1.5/6.ADO.NF	1SNA399930R1700	111	FEH4	1SNA193878R2200	146
BJMI6-3	1SNA176664R0100	111	D1.5/6.D2.ADO.NF	1SNA399742R1700	117	FEH8	1SNA198729R0100	158
BJMI6-4	1SNA176665R0200	111	D1.5/6.S.ADO.NF	1SNA400083R2500	115	FEH9	1SNA198549R0500	155
BJMI6-5	1SNA176666R0300	111	D1.5/7.2ADO.CPE.NF	1SNA400154R0000	121	FEHD1	1SNA199400R0600	147
BJMI8-10	1SNA176673R0200	112	D1.5/7.ADO.CPE.NF	1SNA400153R0700	119	FEHD2	1SNA168949R1700	162
BJMI8-2	1SNA176669R1600	112	D120/42.FF	1SNA190003R2200	198	FEMAD3	1SNA399802R0500	110
BJMI8-3	1SNA176670R1300	112	D185/55.FF	1SNA190004R2300	199	FEMT1	1SNA193137R0300	214
BJMI8-4	1SNA176671R0000	112	D2.5/7.2ADO.CPE.NF	1SNA400062R0700	123	FESDH	1SNA400799R0000	159
BJMI8-5	1SNA176672R0100	112	D2.5/7.2CPE	1SNA400703R1700	126	FIC F.ADO.T1.10PNF	1SSS266210R8800	128
BJS13-10	1SNA167224R2700	190	D2.5/7.ADO.CPE.NF	1SNA400061R0600	122	FIC F.ADO.T1.2PNF	1SSS266202R8800	128
BJS27-2	1SNA205772R1300	196	D2.5/7.ADO.CPE.NF1	1SNA400156R0200	120	FIC F.ADO.T1.3PNF	1SSS266203R8800	128
BJS27-3	1SNA205773R1400	196				FIC F.ADO.T1.4PNF	1SSS266204R8800	128

Type classification

Type	Part Number	Page	Type	Part Number	Page	Type	Part Number	Page
FIC F.ADO.T1.5P.NF	1SSS266205R8800	128	HD35/16.F6.19.1	1SNA295399R0000	183	LH-J	1SNK900606R0000	54
FIC F.ADO.T1.6P.NF	1SSS266206R8800	128	HD4/10.F4.19	1SNA295298R0300	178	LH-R1	1SNK900607R0000	314
FIC F.ADO.T1.7P.NF	1SSS266207R8800	128	HD4/9.F4	1SNA295391R2000	176	M6/8.STP	1SNA195212R1000	214
FIC F.ADO.T1.8P.NF	1SSS266208R8800	128	HD4/9.F4.2	1SNA205392R0700	177	MC512	1SNK140000R0000	19
FIC F.ADO.T1.9P.NF	1SSS266209R8800	128	HD4/9.FF4	1SNA295392R2100	177	MC512PA	1SNK149999R0000	19
FIC F.ADO.T1.B.10P.NF	1SSS266210R9800	129	HD6/13.FF4	1SNA295014R1100	190	MC612	1SNK150000R0000	22
FIC F.ADO.T1.B.2P.NF	1SSS266202R9800	129	HD6/14.DG	1SNA162309R1000	158	MC612PA	1SNK159999R0000	22
FIC F.ADO.T1.B.3P.NF	1SSS266203R9800	129	HD6/14.DH	1SNA162309R1000	158	MC812	1SNK160000R0000	28
FIC F.ADO.T1.B.4P.NF	1SSS266204R9800	129	HD6/14.SDH	1SNA162971R2700	157	MC812PA	1SNK169999R0000	28
FIC F.ADO.T1.B.5P.NF	1SSS266205R9800	129	HD6/14.SDH.1	1SNA162972R2000	161	MCLH	1SNK900630R0000	316
FIC F.ADO.T1.B.6P.NF	1SSS266206R9800	129	HD6/14.SF.2G.2G	1SNA162988R2100	160	MCLH-R1	1SNK900631R0000	316
FIC F.ADO.T1.B.8P.NF	1SSS266208R9800	129	HD6/22.F12G	1SNA162315R2500	155	MCLH-R1-YL	1SNK900634R0000	316
FIC F.ADO.T2.10P.NF	1SSS267210R8800	131	HD6/24.DH	1SNA400782R0000	153	MCLH-YL	1SNK900633R0000	316
FIC F.ADO.T2.2P.NF	1SSS267202R8800	131	HD6/30.F12G	1SNA399963R0500	156	MG-CPM 13 41790	1SNB041790R0512	19
FIC F.ADO.T2.3P.NF	1SSS267203R8800	131	HD6/7.2G.3G	1SNA399964R0600	156	MG-CPM 13 41791	1SNB041791R0612	28
FIC F.ADO.T2.4P.NF	1SSS267204R8800	131	HD6/7.3G.2G	1SNA295015R1200	154	MG-CPM-01 41090	1SNB041090R0510	201
FIC F.ADO.T2.5P.NF	1SSS267205R8800	131	HD6/7.3G.2G.1	1SNA400788R2700	149	MG-CPM-01 41096	1SNB041096R0810	202
FIC F.ADO.T2.6P.NF	1SSS267206R8800	131	HD6/8.2G.2G.1	1SNA400767R1600	148	MG-CPMFA 43196	1SNB043196R0012	93
FIC F.ADO.T2.7P.NF	1SSS267207R8800	131	HD6/8.2G.2G.2	1SNA400766R1500	147	MG-TAA 49148	1SNB049148R1735	316
FIC F.ADO.T2.8P.NF	1SSS267208R8800	131	HD6/9.2G.3G	1SNA160606R1400	145	MG-TAA 49198	1SNB049198R1735	316
FIC F.ADO.T2.B.10P.NF	1SSS267210R9800	132	HD6/9.2G.3G.1	1SNA160606R1400	145	MG-TAA 49448	1SNB049448R8530	316
FIC F.ADO.T2.B.16P.NF	1SSS267216R9800	132	HD6/9.3G.2G	1SNA160564R0100	152	MG-TAA 49498	1SNB049498R8530	316
FIC F.ADO.T2.B.2P.NF	1SSS267202R9800	132	HD6/9.3G.2G.1	1SNA160563R0000	151	MG-TAA 49498	1SNB049498R8530	316
FIC F.ADO.T2.B.3P.NF	1SSS267203R9800	132	HD6/9.5G	1SNA160563R0000	151	MG-TAR 45194	1SNB045194R1735	316
FIC F.ADO.T2.B.4P.NF	1SSS267204R9800	132	HD6/9.SDH.1	1SNA160621R0200	150	MG-TAR 45490	1SNB045490R8530	316
FIC F.ADO.T2.B.5P.NF	1SSS267205R9800	132	HD70/22.F8.31	1SNA400800R0000	159	MG-VYT 46415	1SNB046415R0615	332
FIC F.ADO.T2.B.6P.NF	1SSS267206R9800	132	HD70/22.F8.31.1	1SNA295400R0600	184	MG-VYT 46915	1SNB046915R0615	332
FIC F.ADO.T2.B.8P.NF	1SSS267208R9800	132	HD70/22.F8.31.2	1SNA295401R2300	185	M-W1010PC	1SNA235512R1000	203
FIC F.ADO.T3-.2P.NF	1SSS277202R8800	130	HD70/22.F8.31.2.1	1SNA295402R2400	185	M-W610PC	1SNA235511R0600	201
FIC F.ADO.T3-.3P.NF	1SSS277203R8800	130	INH3	1SNA193934R2300	192	M-W810PC	1SNA235510R0800	202
FIC F.ADO.T3-.4P.NF	1SSS277204R8800	130	INH1	1SNA205427R2200	177	OUMAD	1SNA179466R0600	110
FIC F.ADO.T3-.5P.NF	1SSS277205R8800	130	JB10-10	1SNA295427R1400	176	OUPAD	1SNA178944R0400	110
FIC F.ADO.T3-.6P.NF	1SSS277206R8800	130	JB10-2	1SNK910310R0000	27	PAM43020	1SNA235106R2600	345
FIC F.ADO.T3.FI.10P.NF	1SSS366210R4100	134	JB10-3	1SNA1910302R0000	27	PC	1SNA168497R2300	213
FIC F.ADO.T3.FI.2P.NF	1SSS366202R4100	134	JB10-3	1SNK910303R0000	27	PC5-10	1SNA113544R1200	253
FIC F.ADO.T3.FI.3P.NF	1SSS366203R4100	134	JB10-4	1SNK910303R0000	27	PC5-2	1SNA113542R1000	253
FIC F.ADO.T3.FI.4P.NF	1SSS366204R4100	134	JB10-5	1SNK910304R0000	27	PC8-10	1SNA163313R2400	303
FIC F.ADO.T3.FI.5P.NF	1SSS366205R4100	134	JB12-2	1SNK910305R0000	27	PC81-10	1SNA173523R1100	268
FIC F.ADO.T3.FI.6P.NF	1SSS366206R4100	134	JB12-3	1SNK912303R0000	28	PC8-2	1SNA116538R1700	341
FIC F.ADO.T3.FI.8P.NF	1SSS366208R4100	134	JB12-5	1SNK912305R0000	28	PC8-3	1SNA116539R1000	341
FIC F.ADO.T2.FI.10P.NF	1SSS367210R4100	135	JB16-10	1SNK916310R0000	235	PC8-4	1SNA116540R2500	341
FIC F.ADO.T2.FI.2P.NF	1SSS367202R4100	135	JB16-2	1SNK916302R0000	235	PC8-R1	1SNA400711R0600	301
FIC F.ADO.T2.FI.3P.NF	1SSS367203R4100	135	JB16-3	1SNK916303R0000	235	PC8-R2	1SNA400712R0700	303
FIC F.ADO.T2.FI.4P.NF	1SSS367204R4100	135	JB16-4	1SNK916304R0000	235	PC8-R3	1SNA400713R0000	303
FIC F.ADO.T2.FI.5P.NF	1SSS367205R4100	135	JB16-5	1SNK916305R0000	235	PC8-R4	1SNA400724R0300	303
FIC F.ADO.T2.FI.6P.NF	1SSS367206R4100	135	JB22-10	1SNK916305R0000	237	PC8-R5	1SNA400842R0000	303
FIC F.ADO.T2.FI.8P.NF	1SSS367208R4100	135	JB22-2	1SNK922302R0000	237	PC8-R6	1SNA400843R0000	303
FJHD	1SNA295426R1300	178	JB22-3	1SNK922303R0000	237	PC8-R7	1SNA400849R0000	303
FJH501	1SNA199411R1400	153	JB22-5	1SNK922305R0000	237	PC8-R8	1SNA400850R0000	303
FJHD32	1SNA205431R2600	177	JB26-10	1SNK926310R0000	238	PC-RG2.5-10	1SNA519103R1000	201
FJH50	1SNA295431R1000	176	JB26-2	1SNK926302R0000	238	PC-RG2.5-2	1SNA519103R0200	201
FJHD40	1SNA205424R2700	181	JB26-3	1SNK926303R0000	238	PC-RG2.5-3	1SNA519103R0300	201
FJH50	1SNA295424R1100	178	JB26-5	1SNK926305R0000	238	PC-RG2.5-4	1SNA519103R0400	201
FJH50	1SNA295425R1200	191	JB5-10	1SNK905310R0000	19	PC-RG25-2	1SNA519106R0200	203
HD10/12.F5	1SNA295394R2300	180	JB5-2	1SNK905302R0000	19	PC-RG6-10	1SNA519104R1000	202
HD10/12.F5.1	1SNA295395R2400	181	JB5-3	1SNK905303R0000	19	PC-RG6-2	1SNA519104R0200	202
HD10/12.F5.2	1SNA205396R0300	181	JB5-4	1SNK905304R0000	19	PC-RG6-3	1SNA519104R0300	202
HD10/12.F5.2	1SNA295396R2500	181	JB5-5	1SNK905305R0000	19	PC-RG6-4	1SNA519104R0400	202
HD10/12.F5.3	1SNA295011R1600	179	JB5-50	1SNK905350R0000	19	PC-RG6-7	1SNA519104R0700	202
HD10/12.FF5	1SNA295397R2600	191	JB6-10	1SNK906310R0000	22	PE	1SNA103007R2300	211
HD120/30.F10.31	1SNA295448R0100	186	JB6-2	1SNK906302R0000	22	PEFH	1SNA163497R1600	153
HD120/30.F10.31.1	1SNA295403R2500	187	JB6-3	1SNK906303R0000	22	PG5	1SNK900401R0000	50
HD16/14.FF5.20	1SNA162979R0700	195	JB6-4	1SNK906304R0000	22	PG5-R1	1SNK900402R0000	50
HD16/14.FF5.20.3	1SNA295013R1000	193	JB6-5	1SNK906305R0000	22	PG5-R2	1SNK900403R0000	326
HD16/14.FF5.21	1SNA162991R1400	194	JB6-50	1SNK906350R0000	22	PIB2-TT	1SNA235155R2600	316
HD16/14.FF5.21.3	1SNA295012R1700	192	JB8-10	1SNK908310R0000	25	PIB2-TT-YL	1SNA235157R2000	316
HD185/36.F12.31.1	1SNA295405R2700	188	JB8-10-R1	1SNK908910R0000	302	PL10	1SNK900621R0000	233
HD2.5/6.2G.2G.1	1SNA160487R2500	144	JB8-2	1SNK908302R0000	25	PL16	1SNK900622R0000	235
HD2.5/6.3.2G.2G.1	1SNA190305R0500	166	JB8-2-R1	1SNK908902R0000	302	PL5	1SNK900618R0000	228
HD2.5/6.3.2G.2G.1.GG	1SNA190312R2300	163	JB8-3	1SNK908303R0000	25	PL6	1SNK900619R0000	229
HD2.5/6.3.3G.3G.1	1SNA190316R2700	162	JB8-3-R1	1SNK908903R0000	302	PL8	1SNK900620R0000	232
HD2.5/6.3.GG.1.2GG	1SNA199025R1400	165	JB8-4	1SNK908304R0000	25	PR3.G2	1SNA164800R0300	311
HD2.5/6.3.GG.1.2G.2G	1SNA190314R2500	164	JB8-4-R1	1SNK908904R0000	302	PR3.Z2	1SNA174300R1700	310
HD2.5/6.3.GH.2G.H	1SNA199096R1400	167	JB8-5	1SNK908305R0000	25	PR30	1SNA173220R0500	310
HD35/16.F6.19	1SNA295398R0700	182	JB85-3	1SNK900603R0000	19	PR4	1SNA168500R1200	312
			JB8-5-R1	1SNK908905R0000	302	PR5	1SNA168700R2200	312
			KCO	1SNK900624R0000	303	PR50	1SNA178529R0400	311
			LH	1SNK900605R0000	314	PRH2R	1SNA163350R1500	313

Index_TSNC160034C0201



Index

Type classification

Type	Part Number	Page	Type	Part Number	Page	Type	Part Number	Page
PS-3	1SNK900650R0000	328	ZDK2.5-D2-BL	1SNK805223R0000	89	ZK2.5-T3	1SNK705510R0000	58
PT1	1SSS299253R2800	128	ZDK2.5-D2-PE	1SNK805212R0000	91	ZK2.5-WH	1SNK705065R0000	19
PT2	1SSS299254R2800	128	ZDK4-22	1SNK806010R0000	86	ZK2.5-YL	1SNK705060R0000	19
PT-3	1SNK900625R0000	325	ZDS4-22	1SNK805013R0000	98	ZK4	1SNK706010R0000	22
PT-ZD	1SNK900660R0000	93	ZDS4-22-R1	1SNK806013R0000	100	ZK4-3P	1SNK706011R0000	23
RB-12W7	1SNA290455R0700	119	ZK10	1SNK710010R0000	27	ZK4-3P-BL	1SNK706021R0000	23
RC1010	1SNA238000R1600	239	ZK10-3P	1SNK710011R0000	29	ZK4-3P-OR	1SNK706031R0000	23
RC510	1SNA231000R0700	110	ZK10-3P-BL	1SNK710021R0000	29	ZK4-4P	1SNK706012R0000	24
RC55	1SNA230000R1200	110	ZK10-3P-PV	1SNK710064R0000	30	ZK4-4P-BL	1SNK706022R0000	24
RC610	1SNA233000R0100	111	ZK10-3P-PV-BL	1SNK710067R0000	30	ZK4-4P-OR	1SNK706032R0000	24
RC65	1SNA232000R0000	111	ZK10-BL	1SNK710020R0000	27	ZK4-BK	1SNK706066R0000	22
RC810	1SNA234000R0200	112	ZK10-OR	1SNK710030R0000	27	ZK4-BL	1SNK706020R0000	22
RCPEAD-TT	1SNA235158R0100	316	ZK10-PE	1SNK710150R0000	28	ZK4-OR	1SNK706030R0000	22
RCPEAD-TT-YL	1SNA235159R0200	316	ZK10-PE-3P	1SNK710151R0000	30	ZK4-PE	1SNK706150R0000	22
RCPEB	1SNA178430R0500	316	ZK10-PV	1SNK710063R0000	28	ZK4-PE-3P	1SNK706151R0000	23
RDJ6	1SNA173241R0600	144	ZK10-PV-BL	1SNK710065R0000	28	ZK4-PE-4P	1SNK706152R0000	24
REH3	1SNA1903155R2600	190	ZK16	1SNK712010R0000	31	ZK4-RD	1SNK706062R0000	22
RGW2.5-PE-V0	1SNA511003R0500	201	ZK16-3P	1SNK712011R0000	33	ZK4-YL	1SNK706060R0000	22
RGW2.5-V0	1SNA510003R0000	201	ZK16-3P-BL	1SNK712021R0000	33	ZK6	1SNK708010R0000	25
RGW25-M5-V0	1SNA510005R0000	203	ZK16-3P-PV	1SNK712064R0000	34	ZK6-3P	1SNK708011R0000	26
RGW25-M6-V0	1SNA510006R0000	204	ZK16-3P-PV-BL	1SNK712067R0000	34	ZK6-3P-BL	1SNK708031R0000	26
RGW6-PE-V0	1SNA511024R0500	202	ZK16-BL	1SNK712020R0000	31	ZK6-3P-OR	1SNK708031R0000	26
RGW6-V0	1SNA510024R0000	202	ZK16-PE	1SNK712150R0000	32	ZK6-BK	1SNK708066R0000	25
RILS	1SNK900627R0000	334	ZK16-PE-3P	1SNK712151R0000	34	ZK6-BL	1SNK708020R0000	25
RPED	1SNA163518R2200	153	ZK16-PV	1SNK712063R0000	32	ZK6-OR	1SNK708030R0000	25
RTC	1SNA163156R2700	153	ZK16-PV-BL	1SNK712065R0000	32	ZK6-PE	1SNK708150R0000	25
SCAD	1SNA196896R0000	111	ZK2.5	1SNK705010R0000	19	ZK6-PE-3P	1SNK708151R0000	26
SCAD5	1SNA199551R2000	110	ZK2.5-3P	1SNK705011R0000	20	ZK6-RD	1SNK708062R0000	25
SCH3	1SNA198692R2500	144	ZK2.5-3P-BK	1SNK705073R0000	20	ZK6-YL	1SNK708060R0000	25
SCH6	1SNA199393R2200	192	ZK2.5-3P-BL	1SNK705021R0000	20	ZS10	1SNK508010R0000	232
SCH8	1SNA199412R1500	153	ZK2.5-3P-GN	1SNK705068R0000	20	ZS10-BK	1SNK508066R0000	232
SCHD1	1SNA205428R0300	177	ZK2.5-3P-OR	1SNK705031R0000	20	ZS10-BL	1SNK508020R0000	232
	1SNA295428R2500	176	ZK2.5-3P-RD	1SNK705069R0000	20	ZS10-BR	1SNK508064R0000	232
SCHD2	1SNA205429R0400	181	ZK2.5-3P-WH	1SNK705072R0000	20	ZS10-GN	1SNK508061R0000	232
	1SNA295429R2600	178	ZK2.5-3P-YL	1SNK705067R0000	20	ZS10-OR	1SNK508030R0000	232
SCHD5	1SNA295430R2300	191	ZK2.5-4P	1SNK705012R0000	21	ZS10-PE	1SNK508150R0000	232
SC-JB8-2	1SNK900652R0000	300	ZK2.5-4P-BK	1SNK705080R0000	21	ZS10-PE-R1	1SNK508151R0000	301
SC-JB8-3	1SNK900653R0000	304	ZK2.5-4P-BL	1SNK705022R0000	21	ZS10-PR	1SNK508063R0000	232
SC-JB8-3-OR	1SNK900657R0000	346	ZK2.5-4P-GN	1SNK705075R0000	21	ZS10-R1	1SNK508011R0000	300
SC-JB8-4	1SNK900654R0000	304	ZK2.5-4P-OR	1SNK705032R0000	21	ZS10-RD	1SNK508062R0000	232
SC-JB8-4-OR	1SNK900658R0000	346	ZK2.5-4P-RD	1SNK705076R0000	21	ZS10-S	1SNK508315R0000	259
SC-JB8-5	1SNK900655R0000	346	ZK2.5-4P-WH	1SNK705079R0000	21	ZS10-S-BL	1SNK508320R0000	259
SHB	1SNK900602R0000	54	ZK2.5-4P-YL	1SNK705074R0000	21	ZS10-SF	1SNK508418R0000	281
SHBP	1SNK900601R0000	19	ZK2.5-BK	1SNK705066R0000	19	ZS10-SF-R1	1SNK508421R0000	282
SHBS	1SNK900600R0000	228	ZK2.5-BL	1SNK705020R0000	19	ZS10-SF-R3	1SNK508422R0000	282
SSB20	1SNA103098R2600	216	ZK2.5-CH-4P-LR	1SNK705710R0000	63	ZS10-SP	1SNK508316R0000	264
SSB20T	1SNA103099R2700	216	ZK2.5-CH-4P-RL	1SNK705711R0000	64	ZS10-S-R2	1SNK508417R0000	283
TC5	1SNK900200R0000	19	ZK2.5-D1	1SNK705211R0000	55	ZS10-ST	1SNK508310R0000	302
TC5-R1	1SNK900201R0000	19	ZK2.5-D1-PE	1SNK705209R0000	54	ZS10-ST-1	1SNK508312R0000	300
TGA8	1SNA168672R1100	268	ZK2.5-D2	1SNK705210R0000	54	ZS10-ST-T4	1SNK508311R0000	300
	1SNA168673R1200	268	ZK2.5-D2-BL	1SNK705220R0000	54	ZS10-WH	1SNK508065R0000	232
	1SNA168674R1300	268	ZK2.5-D2-PE	1SNK705212R0000	56	ZS10-YL	1SNK508060R0000	232
TO3.5-100-INS	1SNK900644R0000	328	ZK2.5-D-CH2-DU-RL	1SNK705219R0000	67	ZS150	1SNK531010R0000	239
TO3.5-50	1SNK900640R0000	328	ZK2.5-D-CH-DU	1SNK705214R0000	66	ZS150-BL	1SNK531020R0000	239
TO3.5-50-A	1SNK900659R0000	328	ZK2.5-D-CH-UD	1SNK705213R0000	65	ZS150-YL	1SNK531060R0000	239
TO4-100	1SNK900641R0000	328	ZK2.5-GN	1SNK705061R0000	19	ZS16	1SNK510010R0000	233
TO5.5-125	1SNK900642R0000	328	ZK2.5-L-L-PE	1SNK705512R0000	60	ZS16-BL	1SNK510020R0000	233
TO6.5-150	1SNK900643R0000	328	ZK2.5-L-N-PE	1SNK705513R0000	61	ZS16-OR	1SNK510030R0000	233
TP2	1SNK900203R0000	28	ZK2.5-OR	1SNK705030R0000	19	ZS16-PE	1SNK510150R0000	233
TP4	1SNK900205R0000	28	ZK2.5-PE	1SNK705150R0000	19	ZS240	1SNK536010R0000	240
UMH	1SNK900611R0000	28	ZK2.5-PE-3P	1SNK705151R0000	20	ZS240-BL	1SNK536020R0000	240
VRADO CPE7	1SNA400063R0000	119	ZK2.5-PE-4P	1SNK705152R0000	21	ZS240-YL	1SNK536060R0000	240
VR-ZD	1SNK900637R0000	93	ZK2.5-RD	1SNK705062R0000	19	ZS25	1SNK512010R0000	234
VSJ6	1SNA167735R2700	144	ZK2.5-S	1SNK705310R0000	47	ZS25-BL	1SNK512020R0000	234
ZD2.5-11	1SNK805016R0000	80	ZK2.5-S-4P	1SNK705312R0000	48	ZS25-PE	1SNK512150R0000	234
ZD2.5-22	1SNK805017R0000	81	ZK2.5-S-4P-BL	1SNK705321R0000	48	ZS25-YL	1SNK512060R0000	234
ZD2.5-22-PE	1SNK805156R0000	82	ZK2.5-S-4P-OR	1SNK705331R0000	48	ZS35	1SNK512010R0000	235
ZDK2.5-11	1SNK805015R0000	83	ZK2.5-S-BL	1SNK705320R0000	47	ZS35-BL	1SNK516020R0000	235
ZDK2.5-11-BL	1SNK805025R0000	83	ZK2.5-SF	1SNK706410R0000	49	ZS35-OR	1SNK516030R0000	235
ZDK2.5-11-PE	1SNK805150R0000	87	ZK2.5-SF-R1	1SNK706411R0000	53	ZS35-PE	1SNK516150R0000	235
ZDK2.5-21	1SNK805014R0000	84	ZK2.5-SF-R3	1SNK706412R0000	53	ZS35-PEN	1SNK516170R0000	249
ZDK2.5-22	1SNK805010R0000	85	ZK2.5-S-OR	1SNK705330R0000	47	ZS4	1SNK505010R0000	228
ZDK2.5-22-BL	1SNK805020R0000	85	ZK2.5-SP	1SNK705311R0000	50	ZS4-BK	1SNK505066R0000	228
ZDK2.5-22-PE	1SNK805152R0000	88	ZK2.5-SP-4P	1SNK705313R0000	51	ZS4-BL	1SNK505020R0000	228
ZDK2.5-D1	1SNK805214R0000	90	ZK2.5-S-R1	1SNK706310R0000	49	ZS4-BR	1SNK505064R0000	228
ZDK2.5-D1-PE	1SNK805250R0000	92	ZK2.5-T1	1SNK705511R0000	59	ZS4-D1	1SNK505211R0000	285
ZDK2.5-D2	1SNK805213R0000	89	ZK2.5-T1-PE	1SNK705550R0000	58	ZS4-D2	1SNK505210R0000	284

Index

Type classification

Type	Part Number	Page	Type	Part Number	Page	Type	Part Number	Page
ZS4-D2-BL	1SNK505220R0000	284	ZS6-D2-BK	1SNK506266R0000	286			
ZS4-D2-OR	1SNK505230R0000	284	ZS6-D2-BL	1SNK506220R0000	286			
ZS4-D2-S	1SNK505315R0000	290	ZS6-D2-OR	1SNK506230R0000	286			
ZS4-D2-SF1	1SNK508425R0000	292	ZS6-D2-PE	1SNK506212R0000	288			
ZS4-D2-SF1-R1	1SNK508423R0000	293	ZS6-D2-RD	1SNK506262R0000	286			
ZS4-D2-SF1-R3	1SNK508424R0000	293	ZS6-D2-WH	1SNK506265R0000	286			
ZS4-D2-S-T2	1SNK505316R0000	291	ZS6-D2-YL	1SNK506260R0000	286			
ZS4-D-CH-DU	1SNK505215R0000	297	ZS6-GN	1SNK506061R0000	229			
ZS4-D-CH-UD	1SNK505214R0000	296	ZS6-OR	1SNK506030R0000	229			
ZS4-GN	1SNK505061R0000	228	ZS6-PE	1SNK506150R0000	229			
ZS4-OR	1SNK505030R0000	228	ZS6-PR	1SNK506063R0000	229			
ZS4-PE	1SNK505150R0000	228	ZS6-RD	1SNK506062R0000	229			
ZS4-PE-R2	1SNK506153R0000	279	ZS6-S	1SNK506315R0000	257			
ZS4-PR	1SNK505063R0000	228	ZS6-S-4S-T2	1SNK506316R0000	258			
ZS4-R1	1SNK508013R0000	272	ZS6-S-BL	1SNK506322R0000	257			
ZS4-R2	1SNK506013R0000	278	ZS6-WH	1SNK506065R0000	229			
ZS4-RD	1SNK505062R0000	228	ZS6-YL	1SNK506060R0000	229			
ZS4-S	1SNK505310R0000	253	ZS70	1SNK522010R0000	237			
ZS4-S-BL	1SNK505320R0000	253	ZS70-BL	1SNK522020R0000	237			
ZS4-SF	1SNK506410R0000	274	ZS70-PE	1SNK522150R0000	237			
ZS4-SF1	1SNK508410R0000	268	ZS70-YL	1SNK522060R0000	237			
ZS4-SF1-OR	1SNK508430R0000	268	ZS95	1SNK526010R0000	238			
ZS4-SF1-R1	1SNK508412R0000	270	ZS95-BL	1SNK526020R0000	238			
ZS4-SF1-R2	1SNK508413R0000	271	ZS95-PE	1SNK526150R0000	238			
ZS4-SF1-R3	1SNK508414R0000	270	ZS95-YL	1SNK526060R0000	238			
ZS4-SF1-R4	1SNK508415R0000	271						
ZS4-SF1-T2	1SNK508411R0000	269						
ZS4-SF-R1	1SNK506412R0000	276						
ZS4-SF-R2	1SNK506413R0000	277						
ZS4-SF-R3	1SNK506415R0000	276						
ZS4-SF-R4	1SNK506416R0000	277						
ZS4-SF-T2	1SNK506411R0000	275						
ZS4-S-OR	1SNK505330R0000	253						
ZS4-SP	1SNK505313R0000	260						
ZS4-SP-R1	1SNK506313R0000	262						
ZS4-SP-T2	1SNK505314R0000	261						
ZS4-SP-T2-R1	1SNK506314R0000	263						
ZS4-S-R1	1SNK506310R0000	255						
ZS4-S-R1-BL	1SNK506320R0000	255						
ZS4-S-R1-OR	1SNK506330R0000	255						
ZS4-S-R2	1SNK506414R0000	280						
ZS4-S-R3	1SNK508416R0000	273						
ZS4-S-R3-T2	1SNK508419R0000	273						
ZS4-S-T2	1SNK505311R0000	254						
ZS4-S-T2.3	1SNK505312R0000	254						
ZS4-S-T2.3-R1	1SNK506312R0000	256						
ZS4-S-T2-BL	1SNK505321R0000	254						
ZS4-S-T2-OR	1SNK505331R0000	254						
ZS4-S-T2-R1	1SNK506311R0000	256						
ZS4-S-T2-R1-BL	1SNK506321R0000	256						
ZS4-S-T2-R1-OR	1SNK506331R0000	256						
ZS4-T3	1SNK505212R0000	294						
ZS4-T3-R1	1SNK506213R0000	295						
ZS4-WH	1SNK505065R0000	228						
ZS4-YL	1SNK505060R0000	228						
ZS50	1SNK516011R0000	236						
ZS50-BK	1SNK516064R0000	236						
ZS50-BL	1SNK516021R0000	236						
ZS50-PE	1SNK516151R0000	236						
ZS50-RD	1SNK516063R0000	236						
ZS50-YL	1SNK516060R0000	236						
ZS6	1SNK506010R0000	229						
ZS6-3S	1SNK506011R0000	230						
ZS6-3S-BL	1SNK506021R0000	230						
ZS6-3S-PE	1SNK506151R0000	230						
ZS6-3S-YL	1SNK506067R0000	230						
ZS6-4S	1SNK506012R0000	231						
ZS6-4S-BL	1SNK506022R0000	231						
ZS6-4S-PE	1SNK506152R0000	231						
ZS6-4S-YL	1SNK506068R0000	231						
ZS6-BK	1SNK506066R0000	229						
ZS6-BL	1SNK506020R0000	229						
ZS6-BR	1SNK506064R0000	229						
ZS6-D1	1SNK506211R0000	287						
ZS6-D1-PE	1SNK506250R0000	286						
ZS6-D1-RD	1SNK506214R0000	287						
ZS6-D2	1SNK506210R0000	286						

Notes

