

Pushbutton Enclosures - NEMA 4, 4X

1435/ 1435M Stainless Steel Series

Operator Interface Enclosure

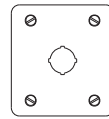

1

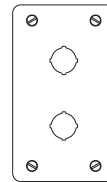

2

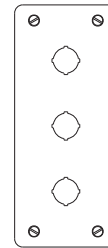

3

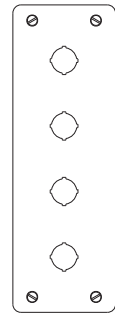

4

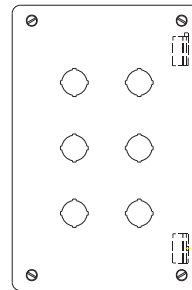

6

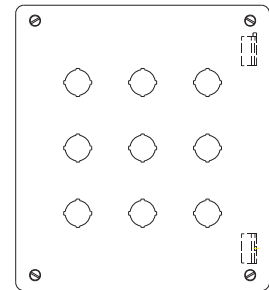

9

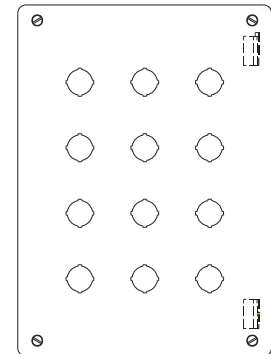

12

Application

- Designed to accept standard heavy duty oil tight pushbuttons, switches and pilot lights.
- Provides protection from dirt, dust, oil and large amounts of water from any angle, or where highly corrosive conditions exist.

Standards

- UL 508 Type 4 and 4X
- CSA Type 4 and 4X
- **Complies with**
 - NEMA Type 3R, 4 and 4X
 - JIC Standard EGP-1-1967
 - IEC 60529, IP66
- Appropriate components are required to maintain these standards.

Construction

- Formed 14 gauge stainless steel except A and B which are 16 gauge.
- 304 or 316 SS *see table*.
- Smooth continuously welded seams.
- Welded brackets provide for enclosure mounting.
- Captive stainless steel cover screws thread into sealed wells.
- Larger enclosures provide internally hinged removable covers, designed to hold the cover open during wiring (see table).
- Oil resistant gasket and adhesive.
- A bonding stud is provided on the door and a grounding stud is provided on the enclosure.

Finish

- Natural stainless steel with a smooth brushed finish.

Accessories

- Hole plugs...*see page 435*

Technical references and CAD downloads available at www.hammondmfg.com

All dimensions in inches unless specified otherwise

Pushbutton Enclosures

Pushbutton Enclosures - NEMA 4, 4X

1435/ 1435M Stainless Steel Series

Operator Interface Enclosure

Pushbutton Enclosures

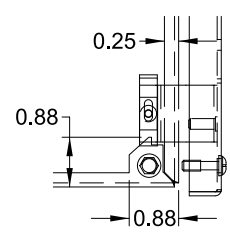
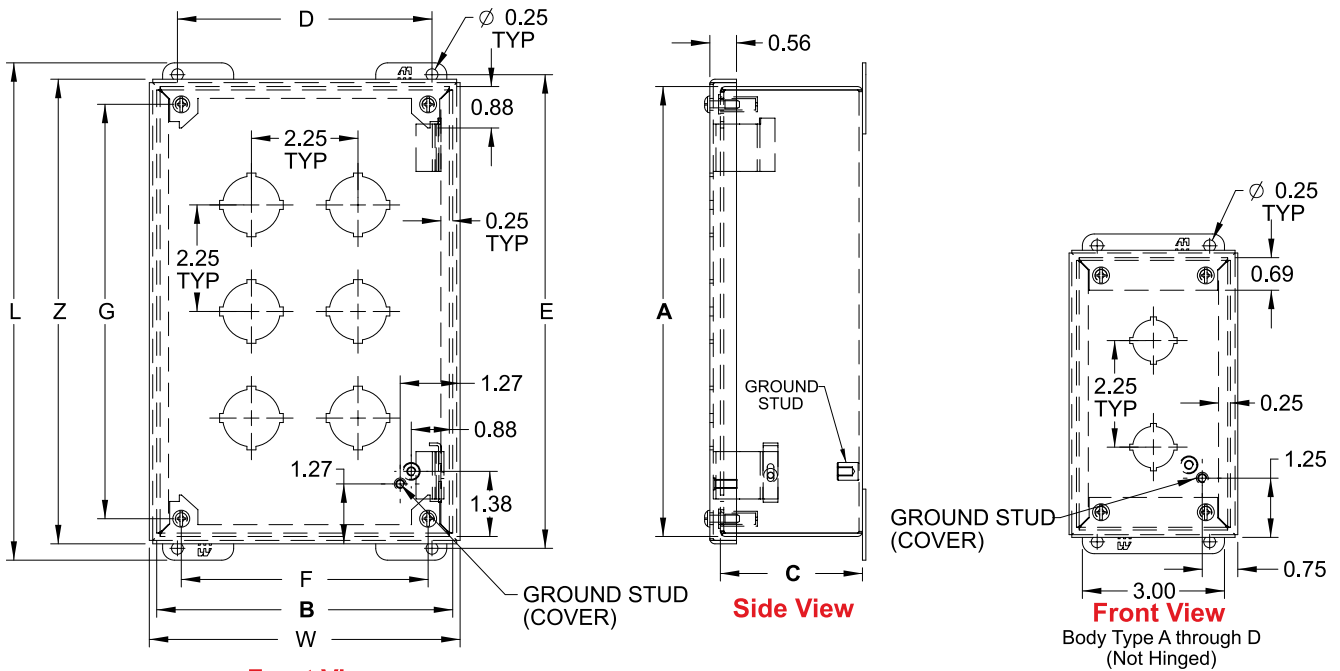

Retractable pin allows door to be mounted on left or right side

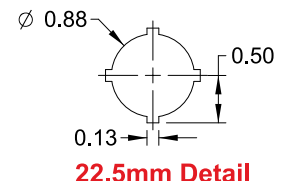
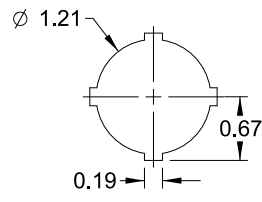

Part No.				No. Of Holes	Overall Dimensions												Ship Wt. lbs.
304 S.S. 22.5mm	304 S.S. 30.5mm	316 S.S. 22.5mm	316 S.S. 30.5mm		A	B	C	D	E	F	G	L	W	Z			
1435MSSA ¹	1435SSA ¹	1435MS16A ¹	1435S16A ¹	1	3.50	3.25	2.75	2.38	4.00	2.21	2.75	4.50	3.56	3.81	2		
1435MSSB ¹	1435SSB ¹	1435MS16B ¹	1435S16B ¹	2	5.75	3.25	2.75	2.38	6.25	2.21	5.00	6.75	3.56	6.06	3		
1435MSSC ¹	1435SSC ¹	1435MS16C ¹	1435S16C ¹	3	8.00	3.25	2.75	2.38	8.50	2.21	7.25	9.00	3.56	8.31	3		
1435MSSD ¹	1435SSD ¹	1435MS16D ¹	1435S16D ¹	4	10.25	3.25	2.75	2.38	10.75	2.21	9.50	11.25	3.56	10.56	4		
1435MSSH	1435SSH	1435MS16H	1435S16H	6	9.50	6.25	3.00	5.38	10.00	5.21	8.75	10.50	6.56	9.81	6		
1435MSSK	1435SSK	1435MS16K	1435S16K	9	9.50	8.50	3.00	7.63	10.00	7.46	8.75	10.50	8.81	9.81	7		
1435MSSO	1435SSO	1435MS16O	1435S16O	12	11.75	8.50	3.00	7.63	12.25	7.46	11.00	12.75	8.81	12.06	8		

¹ Not Hinged

Technical references and CAD downloads available at www.hammondmfg.com All dimensions in inches unless specified otherwise

Quality Products. Service Excellence.