



# Simple, Trip-less and Environment-friendly Compact Inverter!

# X200 Series

## VARIABLE FREQUENCY DRIVE



## Environment-friendly Inverter

RoHS compliance for all models.



## Integrated EMC Filter

Cost and space reduction compared with external EMC filter. (European version only)

Single-phase input : EN61800-3 cat.C1  
Three-phase input : EN61800-3 cat.C2

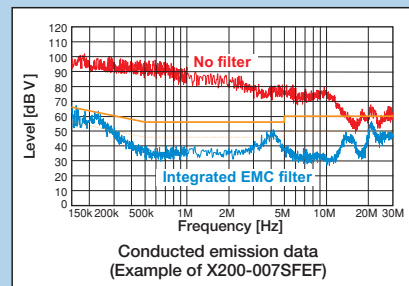

## Emergency Stop Function

Shut off INV output by hardware without software(CPU) high quality emergency stop.



## Improved Trip Avoidance Function

Over current and over voltage suppressing function is incorporated. This function reduces inverter tripping. The X200 decelerates and stops the motor using regenerative energy from the motor even though the power is not supplied.

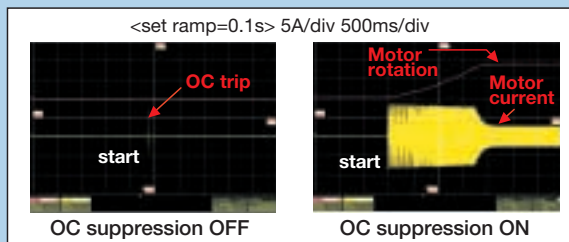

## Non-stop operation at IPF

This can achieve smooth retry even when the IPF (Instantaneous Power Failure) occurs. This is useful especially in Fan and pump application.

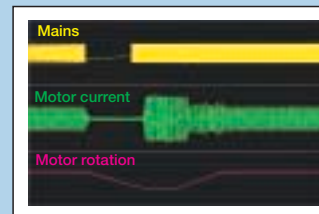

## Model Configuration

| Applicable Motor kW (HP) | 1-/3-phase 200V class |                  |                  | 3-phase 400V class |                  |
|--------------------------|-----------------------|------------------|------------------|--------------------|------------------|
|                          | US version            | European version | Japanese version | US version         | European version |
| 0.2(1/4)                 | X200-002NFU           | X200-002SFEF     | X200-002LFRF     |                    |                  |
| 0.4(1/2)                 | X200-004NFU           | X200-004SFEF     | X200-004LFRF     | X200-004HFU        | X200-004HFEF     |
| 0.55(3/4)                |                       | X200-005SFEF     |                  |                    |                  |
| 0.75(1)                  | X200-007NFU           | X200-007SFEF     | X200-007LFRF     | X200-007HFU        | X200-007HFEF     |
| 1.1(1.5)                 |                       | X200-011SFEF     |                  |                    |                  |
| 1.5(2)                   | X200-015NFU           | X200-015SFEF     | X200-015LFRF     | X200-015HFU        | X200-015HFEF     |
| 2.2(3)                   | X200-022NFU           | X200-022SFEF     | X200-022LFRF     | X200-022HFU        | X200-022HFEF     |
| 3.0(4)                   |                       |                  |                  |                    | X200-030HFEF     |
| 3.7(5)                   | X200-037LFU           |                  | X200-037LFRF     |                    |                  |
| 4.0(5)                   |                       |                  |                  | X200-040HFU        | X200-040HFEF     |
| 5.5(7.5)                 | X200-055LFU           |                  | X200-055LFRF     | X200-055HFU        | X200-055HFEF     |
| 7.5(10)                  | X200-075LFU           |                  | X200-075LFRF     | X200-075HFU        | X200-075HFEF     |

# 6

## Automatic Energy-saving Function

The X200 delivers "real-time" energy-saving operation for your fan and pump applications. This function insures that motor operates at minimum current in response to the torque required by the load.

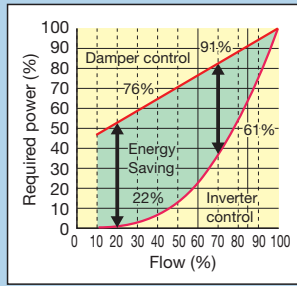

# 7

## Micro Surge Voltage suppress function (Patent registered in Japan,USA & Korea)

Hitachi original PWM control suppressing Motor terminal Voltage less than 2 times of INV DC voltage E.  
Lower than Hitachi motor Max. insulation voltage (1,250V)  
(during regenerating operation increase the DC bus voltage may over motor max. insulation voltage)

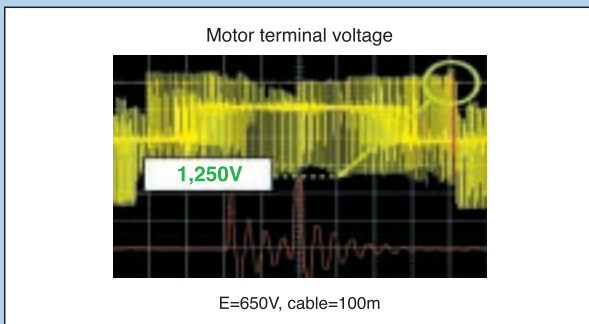

# 8

## Network Compatibility

RS-485 is provided as standard for Modbus-RTU serial communication PROFIBUS, CANopen option modules are available soon.

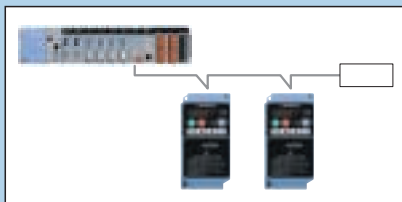

# 9

## Side-by-side installation

Since an inverter can be stuck and installed in a horizontal direction, a space can be used effectively.

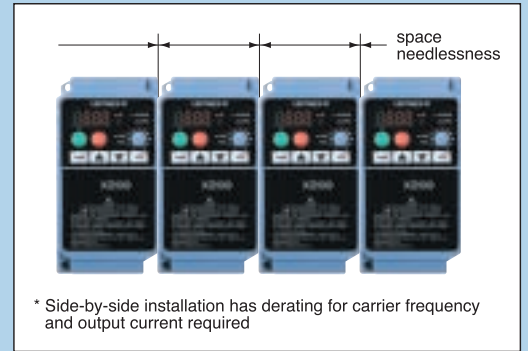

# 10

## Versatile Functions

- Pure analog monitor output(10-bit, 0-10VDC)
- Low load detection
- External thermistor terminal (PTC)
- Cooling-fan on/off
- Instantaneous power failure recovery
- Second motor setting
- 3-wire control
- Analog input selection
- Second acceleration/deceleration setting
- Jogging
- Auto-carrier frequency reduction
- Unattended start protection (USP)
- Analog input wire-break detection

# 11

## Global Performance

- Conformity to global standards CE, UL, c-UL and c-Tick approvals



|                                       |   |
|---------------------------------------|---|
| <p><b>ISO 14001</b><br/>EC97J1095</p> | <p>Hitachi variable frequency drives (inverters) in this brochure are produced at the factory registered under the ISO 14001 standard for environmental management system and the ISO 9001 standard for inverter quality management system.</p> |
| <p><b>ISO 9001</b><br/>JQA-1153</p>   |   |

## Model Name Indication

### X200-004 H F E F

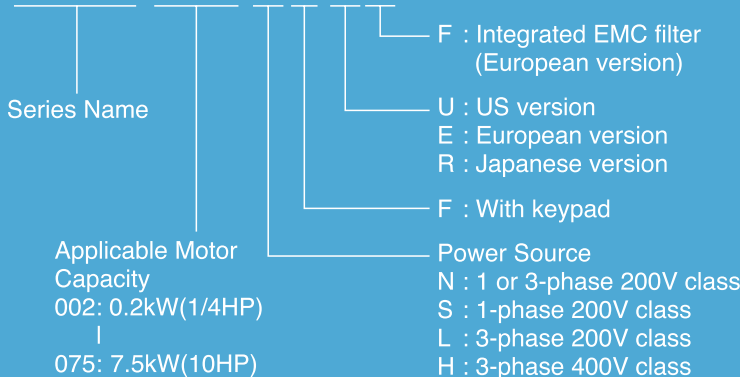

## CONTENTS

|  |       |
|--|-------|
| Features                               | 1-2   |
| Standard Specifications                | 3     |
| Dimensions                             | 4     |
| Operation and Programming              | 5     |
| Operation / Terminal Functions         | 6     |
| Function List                          | 7-9   |
| Protective Functions                   | 10    |
| Connecting Diagram                     | 11-12 |
| Wiring and Accessories                 | 13    |
| Torque characteristics/Derating Curves | 14    |
| For Correct Operation                  | 15-16 |

# Standard Specifications

## 1-/3-phase 200V class

| Model X200-           |   | European Version | 002SFEF   | 004SFEF  | 005SFEF   | 007SFEF | 011SFEF  | 015SFEF | 022SFEF | -                 | -        | -       |  |  |
|-----------------------|---|------------------|---|----------|-----------|---------|----------|---------|---------|-------------------|----------|---------|--|--|
|                       |   | US Version       | 002NFU  | 004NFU   | -         | 007NFU  | -        | 015NFU  | 022NFU  | 037LFU            | 55LFU    | 075LFU  |  |  |
| Output Ratings        | Applicable motor size, 4-pole kW(HP) *1 |                  | 0.2(1/4)  | 0.4(1/2) | 0.55(3/4) | 0.75(1) | 1.1(1.5) | 1.5 (2) | 2.2(3)  | 3.7(5)            | 5.5(7.5) | 7.5(10) |  |  |
|                       | Rated capacity                          | 230V             | 0.5   | 1.0      | 1.1       | 1.5     | 1.9      | 2.8     | 3.9     | 6.3               | 9.6      | 12.7    |  |  |
|                       |   | 240V             | 0.5   | 1.0      | 1.2       | 1.6     | 2.0      | 2.9     | 4.1     | 6.6               | 9.9      | 13.3    |  |  |
|                       | Rated output current (A) *2             |                  | 1.4   | 2.6      | 3.0       | 4.0     | 5.0      | 7.1     | 10.0    | 15.9              | 24.0     | 32.0    |  |  |
|                       | Overload capacity/output current)       |                  | 150% for 60 sec.  |          |           |         |          |         |         |                   |          |         |  |  |
|                       | Rated output voltage (V)                |                  | 3-phase (3-wire) 200 to 240V (corresponding to input voltage) |          |           |         |          |         |         |                   |          |         |  |  |
| Input Rating          | Rated input voltage (V)                 |                  | SFEF: 1-phase 200 to 240V+10%, -15%, 50/60Hz±5%               |          |           |         |          |         |         |                   |          |         |  |  |
|                       |   |                  | NFU: 1-/3-phase 200 to 240V+10%, -15%, 50/60Hz±5%             |          |           |         |          |         |         |                   |          |         |  |  |
|                       |   |                  | LFU: 3-phase 200 to 240V+10%, -15%, 50/60Hz±5%                |          |           |         |          |         |         |                   |          |         |  |  |
| Enclosure *4          |   |                  | Self-cooling  |          |           |         |          | IP20    |         | Force ventilation |          |         |  |  |
| Cooling method        |   |                  | Self-cooling  |          |           |         |          | IP20    |         | Force ventilation |          |         |  |  |
| Integrated EMC filter | -SFEF                                   |                  | EN61800-3 category C1 filter                                  |          |           |         |          |         |         |                   |          |         |  |  |
|                       | -NFU/LFU                                |                  | -   |          |           |         |          |         |         |                   |          |         |  |  |
| Weight (kg)           | -SFEF                                   |                  | 0.8   | 1.0      | 1.5       | 1.5     | 2.4      | 2.4     | 2.5     | -                 | -        | -       |  |  |
|                       | -NFU/LFU                                |                  | 0.8   | 0.9      | -         | 1.5     | -        | 2.3     | 2.4     | 2.3               | 4.2      | 4.2     |  |  |

## 3-phase 400V class

| Model X200-           |   | European Version | 004HFEF   | 007HFEF | 015HFEF | 022HFEF | 030HFEF | 040HFEF | 055HFEF  | 075HFEF           |     |  |  |  |
|-----------------------|---|------------------|---|---------|---------|---------|---------|---------|----------|-------------------|-----|--|--|--|
|                       |   | US Version       | 004HFU  | 007HFU  | 015HFU  | 022HFU  | -       | 040HFU  | 055HFU   | 075HFU            |     |  |  |  |
| Output Ratings        | Applicable motor size, 4-pole kW(HP) *1 |                  | 0.4(1/2)  | 0.75(1) | 1.5 (2) | 2.2(3)  | 3(4)    | 4(5)    | 5.5(7.5) | 7.5(10)           |     |  |  |  |
|                       | Rated capacity                          | 400V             | 1.0   | 1.7     | 2.6     | 3.8     | 5.4     | 5.9     | 9.0      | 11.1              |     |  |  |  |
|                       |   | 480V             | 1.2   | 2.0     | 3.1     | 4.5     | 6.4     | 7.1     | 10.8     | 13.3              |     |  |  |  |
|                       | Rated output current (A) *2             |                  | 1.5   | 2.5     | 3.8     | 5.5     | 7.8     | 8.6     | 13.0     | 16.0              |     |  |  |  |
|                       | Overload capacity/output current)       |                  | 150% for 60 sec.  |         |         |         |         |         |          |                   |     |  |  |  |
|                       | Rated output voltage (V)                |                  | 3-phase (3-wire) 380 to 480V (corresponding to input voltage) |         |         |         |         |         |          |                   |     |  |  |  |
| Input Rating          | Rated input voltage (V)                 |                  | 3-phase 380 to 480V +10%, -15%, 50/60Hz±5%                    |         |         |         |         |         |          |                   |     |  |  |  |
|                       |   |                  | IP20  |         |         |         |         |         |          |                   |     |  |  |  |
| Enclosure *4          |   |                  | Self-cooling  |         |         |         |         | IP20    |          | Force ventilation |     |  |  |  |
| Cooling method        |   |                  | Self-cooling  |         |         |         |         | IP20    |          | Force ventilation |     |  |  |  |
| Integrated EMC filter | -HFEF                                   |                  | EN61800-3 category C2 filter                                  |         |         |         |         |         |          |                   |     |  |  |  |
|                       | -HFU                                    |                  | -   |         |         |         |         |         |          |                   |     |  |  |  |
| Weight (kg)           | -HFEF                                   |                  | 1.5   | 2.3     | 2.4     | 2.4     | 2.4     | 2.4     | 4.2      | 4.2               | 4.2 |  |  |  |
|                       | -HFU                                    |                  | 1.4   | 2.2     | 2.3     | 2.3     | -       | 2.3     | 4.2      | 4.2               | 4.2 |  |  |  |

## General Specifications

| Item            |                                  | General Specifications  |  |
|-----------------|----------------------------------|---|--|
| Control         | Control method                   | Line-to-line sine wave pulse-width modulation (PWM) control   |  |
|                 | Output frequency range *5        | 0.5 to 400Hz  |  |
|                 | Frequency accuracy *6            | Digital command ±0.01%, Analog command±0.4% (25±10°C)   |  |
|                 | Frequency setting resolution     | Digital: 0.1Hz, Analog: (max frequency)/1000  |  |
|                 | Voltage/Frequency Characteristic | V/f control, V/f variable (constant torque, reduced torque)   |  |
|                 | Acceleration/deceleration time   | 0.01 to 3000 sec. (linear, sigmoid), two-stage accel./decel.  |  |
|                 | Starting torque *7               | 100%/6Hz  |  |
|                 | Carrier frequency range          | 2.0 to 12kHz  |  |
| Input terminal  | Protective functions             | Over-current, over-voltage, under-voltage, overload, overheat, ground fault at power-on, input over-voltage, external trip, EEPROM error, CPU error, USP error, Termistor error, Driver error, Emergency stop   |  |
|                 | Specification                    | 10kohm input impedance, sink/source logic selectable  |  |
| Output signal   | Intelligent output terminal      | Functions   | FW(Forward), RV(Reverse), CF1-CF4(Multispeed command), JG(Jogging), DB(External DC braking), SET(Second motor constants setting), 2CH(Second accel./decel.), FRS(Free-run stop), EXT(External trip), USP(Unattended start protection), SFT(Software lock), AT(Analog input selection), RS(Reset), PTC(Thermistor input) *8, STA(3-wire start), STP(3-wire stop), F/R(3-wire fwd./rev.), PID(PID On/Off), PIDC(PID reset), UP/DWN(Remote-controlled accel./decel.), UDC(Remote-controlled data clearing), OPE(Operator control), ADD(ADD frequency enable), F-TM(force terminal mode), RDY(quick start enable), S-ST(Special-Set 2nd Motor Data), EMR(Emergency stop), NO(Not selected) |
|                 |                                  | Specification   | 27V DC 50mA max open collector output, 1 terminals<br>1c output 250V AC/30V DC 2.5A relay (ALO, AL1, AL2 terminals)  |
| Operator        | Display                          | Function  | RUN(run signal), FA1(Frequency arrival type 1 - constant speed), FA2(Frequency arrival type 2 - over-frequency), OL(overload advance notice signal), OD(Output deviation for PID control), AL(alarm signal), DC(Wire brake detect on analog input), FBV(PID Second Stage Output), NDC(ModBus Network Detection Signal), LOG(Logic Output Function), ODC(Option Card Detection Signal), LOC(Low load)   |
|                 |                                  | Specification   | 0 to 10V DC  |
| Operation       | Status LED Interface             | Function  | Analog Frequency monitor, analog current monitor   |
|                 |                                  | Specification   | 4-digits 7 segment LEDs  |
|                 | Frequency setting                | Operator keypad   | Up and Down keys / Value settings or analog setting via potentiometer on operator keypad   |
|                 |                                  | External signal   | 0 to 10 V DC, 4 to 20 mA   |
| FW/RV Run       | Operator Keypad                  | RS485 interface (Modbus RTU)  |  |
|                 | External signal                  | Run key / Stop key (change FW/RV by function command)   |  |
| Environment     | Operating temperature            | Serial port   | Run key / Stop key (change FW/RV by function command)  |
|                 |                                  | External signal   | FW Run/Stop (NO contact), RV set by terminal assignment (NC/NO), 3-wire input available  |
|                 | Storage temperature              | Serial port   | RS485 interface (Modbus RTU)   |
|                 | Humidity                         |   |  |
| Vibration       |                                  |   |  |
| Location        |                                  |   |  |
| Other functions |                                  | AVR (Automatic Voltage Regulation), V/f characteristic selection, accel./decel. curve selection, frequency upper/lower limit, 16 stage multispeed, PID control, frequency jump, external frequency input bias start/end, jogging, cooling fan On/Off, trip history etc. |  |
| Coating color   |                                  | Blue  |  |
| Options         |                                  | Remote operator with copy function (SRW-0EX), input/output reactors, DC reactors, radio noise filters, braking resistors, braking units, LCR filter, communication cables (ICS-1, 3)  |  |

Note 1: The applicable motor refers to Hitachi standard 3-phase motor (4-pole). When using other motors, care must be taken to prevent the rated motor current (50/60 Hz) from exceeding the rated output current of the inverter.

Note 2: The output voltage decreases as the main supply voltage decreases (except when using the AVR function). In any case, the output voltage cannot exceed the input power supply voltage.

Note 3: The braking torque via capacitive feedback is the average deceleration torque at the shortest deceleration (stopping from 50/60 Hz as indicated). It is not continuous regenerative braking torque. The average decel torque varies with motor loss. This value decreases when operating beyond 50 Hz. If a large regenerative torque is required, the optional regenerative braking resistor should be used.

Note 4: The protection method conforms to JEM 1030.

Note 5: To operate the motor beyond 50/60 Hz, consult the motor manufacturer for the maximum allowable rotation speed.

Note 6: The output frequency may exceed the maximum frequency setting (A004 or A204) for automatic stabilization control.

Note 7: At the rated voltage when using a Hitachi standard 3-phase, 4pole motor.

Note 8: Only terminal 5 is assignable the PTC (thermistor) function.

# Dimensions

[Unit: mm(inch)]  
Inches for reference only

## • X200-002SFEF, NFU

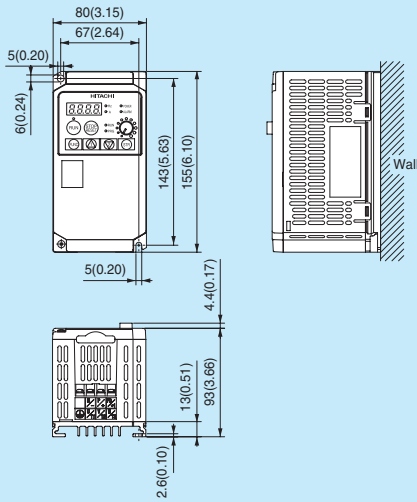

## • X200-004SFEF, NFU

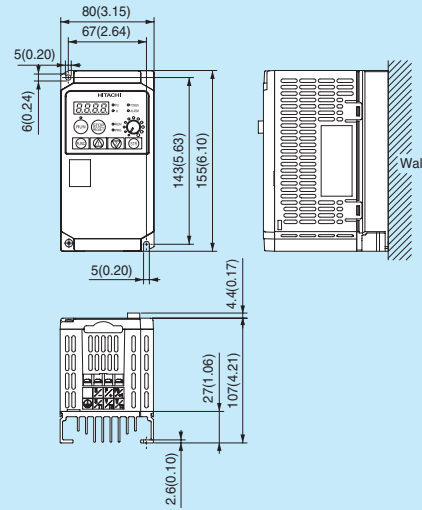

## • X200-005SFEF • X200-004HFEF, HFU

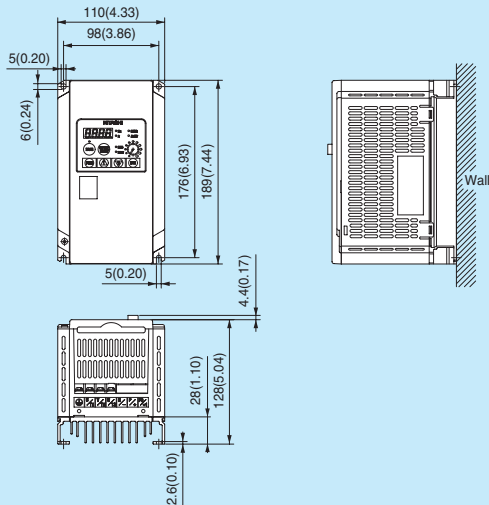

## • X200-007SFEF, NFU

## • X200-011SFEF • X200-015~022SFEF, NFU • X200-037LFU • X200-007~040HFEF, HFU

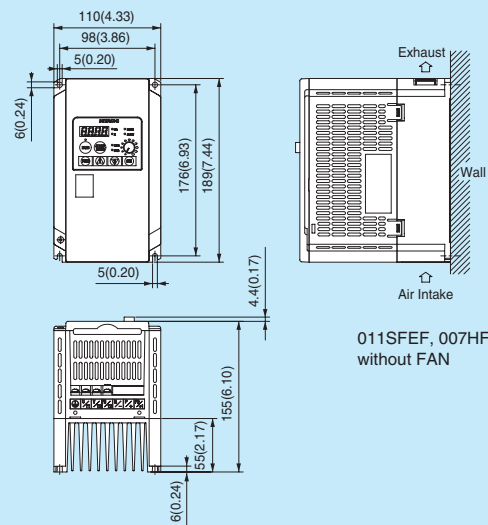

011SFEF, 007HFEF, HFU:  
without FAN

## • X200-055~075LFU, HFU • X200-055~075HFEF

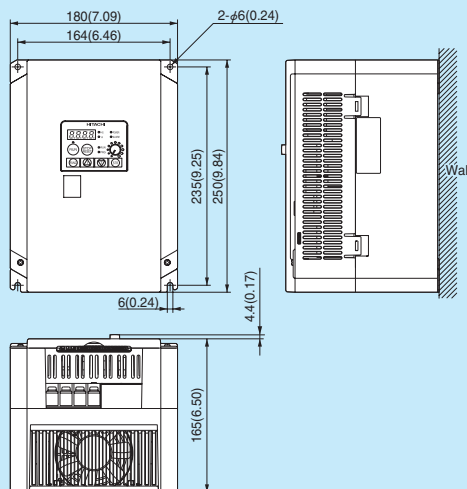

# Operation and Programming

The X200 series can be easily operated with the digital operator provided as standard. The digital operator can also be detached and used for remote-control. An operator with copy function is also available as an option.

## Parameter Display

Displays frequency, motor current, rotational speed of the motor, and an alarm code.

## RUN Key

Press to run the motor.

## STOP/RESET Key

Press to stop the drive or reset an alarm.

## Function Key

Press to set or monitor a parameter value.

## Up/Down Keys

Press up or down to sequence through parameters and functions shown on the display, and increment/decrement values.



## Power LED

Lights when the power input to the drive is ON.

## Display Unit LEDs

Indicates the unit associated with the parameter display.

## Monitor LEDs

Shows drive's status.

## Potentiometer

## Store Key

Press to write the new value to the EEPROM.

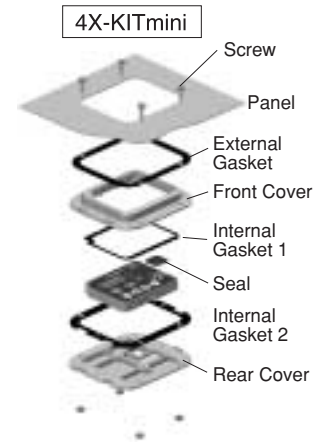

You can mount an optional keypad with the potentiometer part no. OPE-SRmini for a NEMA1 rated installation. The kit also provides for removing the potentiometer knob to meet NEMA 4X requirements, as shown (part no. 4X-KITmini).

## 1. Setting the maximum output frequency

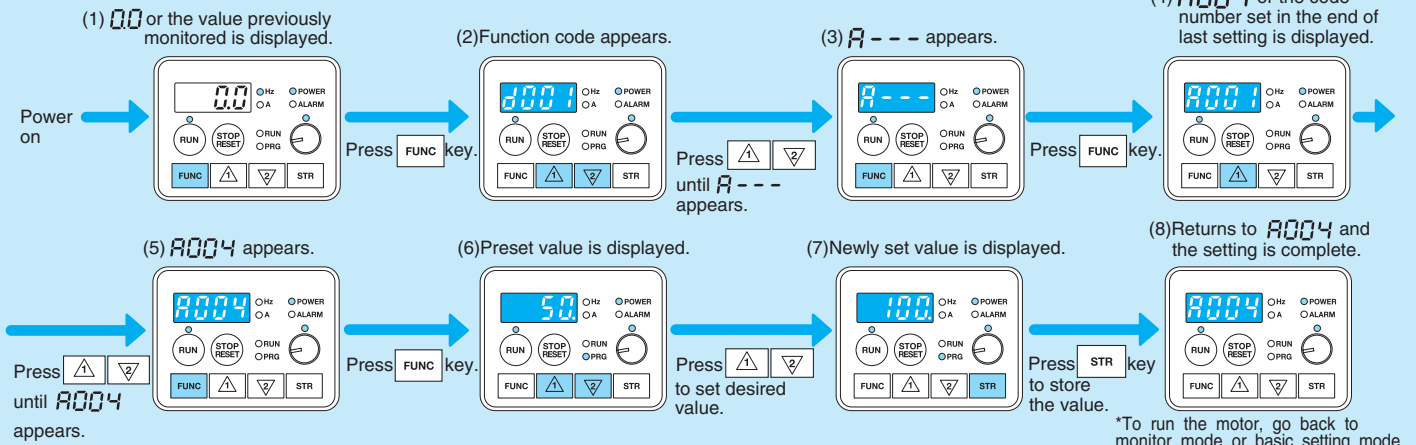

## 2. Running the motor (by potentiometer)

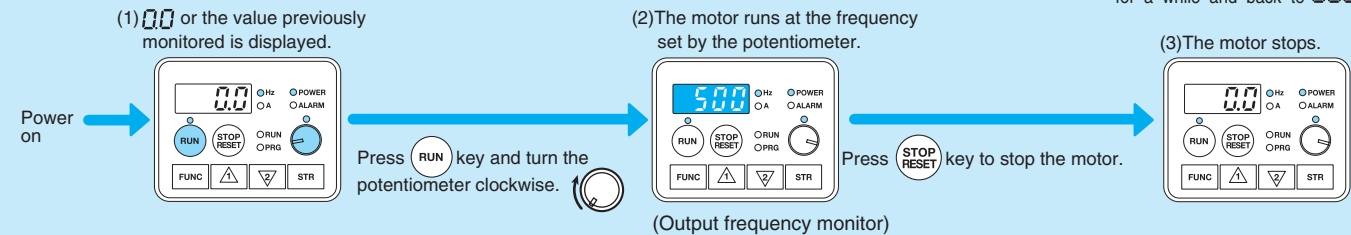

## 3. Monitoring output current value

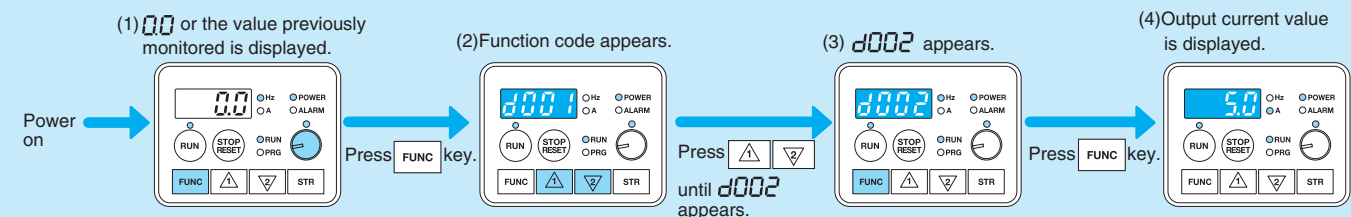

# Operation / Terminal Functions

## Hardware switches

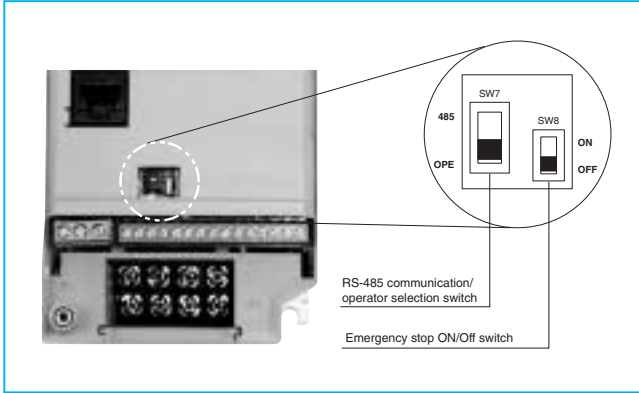

| Switch symbol | Switch Name                                   | Switch Name Description   |
|---------------|---|---|
| SW7           | RS-485 communication/key pad selection switch | Select communication connector destination. *1  |
|               |   | 485 RS-485 communication via Modbus protocol  |
|               |   | OPE [default] Keypad (option)   |
| SW8           | Emergency stop ON/OFF                         | Select frequency and run command input source.<br>The SW8 is for the emergency signal input. If you turn this DIP switch ON, the inverter is ready to receive emergency signal from the dedicated terminal #3. Inverter shuts off the output by means of pure hardware when a signal is given to the terminal. Each signals related to this emergency input must be in accordance with the norm. Additionally, the logic input terminal assign will be changed automatically if the SW8 is made ON. |

Note 1: The standard keypad OPE (OPE-SRmini) can be used either the switch is set to 485 or OPE.

Note 2: Input terminal selection (EMR) cannot be chosen from an operator. If the slide switch SW8 is turned ON, it divides automatically and is attached.

## Terminal Description

### Terminal Symbol

| Terminal Symbol | Terminal Name                              |
|-----------------|--|
| L1,L2,N/L3      | Main power supply input terminals          |
| U/T1,V/T2,W/T3  | Inverter output terminals                  |
| +1,+            | DC reactor connection terminals            |
| + -             | External braking unit connection terminals |
| ⊕               | Ground connection terminal                 |

### Screw Diameter and Terminal Width

| Model                | Screw diameter (mm) | Terminal width W (mm) |
|----------------------|---------------------|-----------------------|
| 002 - 004NFU/SFEF    | M3.5                | 7.1                   |
| 007- 022NFU, 037LFU  | M4                  | 9.2                   |
| 005 - 022SFEF        |                     |                       |
| 004- 040HFU/HFEF     |                     |                       |
| 055- 075LFU/HFU/HFEF | M5                  | 12                    |



### Terminal arrangement

• X200-002~004SFEF, 002~004NFU

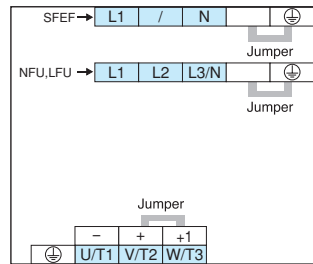

• X200-005~022SFEF, 007~022NFU, 037LFU  
004~040HFEF, 004~040HFU  
055~075LFU, 055~075HFU  
055~075HFEF

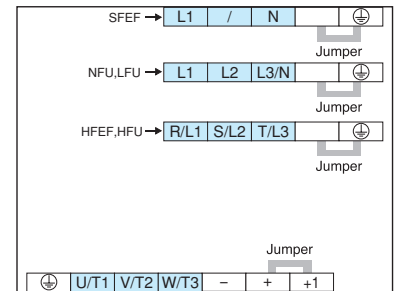

## Control circuit terminals

### Terminal arrangement

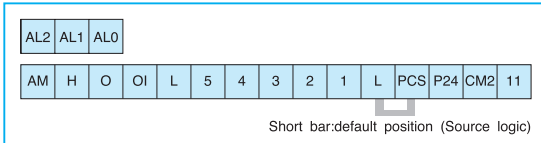

## Terminal function

|                       | Terminal name | Description  | Ranges and Notes  |
|-----------------------|---------------|--|---|
| Input/monitor signals | AM            | Voltage analog output  | 0 to10V DC, 1mA max.  |
|                       | L             | Common for inputs  | -   |
|                       | P24           | +24V for logic inputs  | 24V DC, 30mA (do not short to terminal L)   |
|                       | PCS           | Intelligent input common   | -   |
|                       | 5             | Intelligent (programmable) input terminals, selection from:  |   |
|                       | 4             | FW(Forward), RV(Reverse), CF1-CF4(Multispeed command), JG(Jogging), DB(External DC braking), SET(Second motor constants setting), 2CH(Second accel./decel.), FRS(Free-run stop), EXT(External trip), USP(Unattended start protection), SFT(Software lock), AT(Analog input selection), RS(Reset), PTC(Thermistor input), STA(3-wire start), STP(3-wire stop), F/R(3-wire fwd./rev.), PID(PID On/Off), PIDC(PID reset), UP/DWN(Remote-controlled accel./decel.), UDC(Remote-controlled data clearing), OPE(Operator control), ADD(Frequency setpoint), F-TM(Force terminal enable), RDY(Quick start enable), S-ST(Special-Set 2nd Motor Data), EMR(Emergency stop) or NO(Not selected). |   |
|                       | 3             |  |   |
| 2                     |               |  |   |
| Frequency setting     | H             | +10V analog reference  | 10V DC, 10mA max  |
|                       | O             | Analog input, voltage  | 0 to 10V DC, input impedance10kohm  |
|                       | OI            | Analog input, current  | 4 to 20mA DC, input impedance 250ohm  |
|                       | L             | Common for inputs  | -   |
| Output signals        | 11            | Intelligent (programmable) output terminals, selection from: RUN(run signal), FA1(Frequency arrival type 1 -constant speed), FA2(Frequency arrival type 2 -over-frequency), OL(overload advance notice signal), OD(Output deviation for PID control), AL(alarm signal), DC(Wire brake detect on analog input), FBV(Feedback voltage comparison), NDc(Network Disconnection), LOG(Logic operation result), ODC(Option Card Detection signal), LOC(Low Load Detection).  | Open collector output<br>L level at operation (ON)<br>27V DC, 50mA max.   |
|                       | CM2           | Common for intelligent output terminals  | -   |
| Relay output          | AL2           |  | AC250V 2.5A (Resistive load)<br>0.2A (cosφ=0.4)<br>DC30V 3.0A (Resistive load)<br>0.7A (cosφ=0.4)<br>(minimum) AC100V 10mA<br>DC 5V 100mA |
|                       | AL1           |  |   |
|                       | AL0           |  |   |

# Function List

The parameter tables in this chapter have a column titled "Run Mode Edit." An Ex mark x means the parameter cannot be edited; a Check mark ✓ means the parameter can be edited. The table example to the right contains two adjacent marks "x ✓". These two marks (that can also be "xx" or "✓ ✓") correspond to low-access or high-access levels to Run Mode edits (note *Lo* and *Hi* in column heading).

## Monitoring and main profile parameters

✓: Allowed  
X: Not allowed

| Function Code           | Name                       | Range                                   | Default   | Unit | Run mode edit |    |   |
|-------------------------|----------------------------|---|---|------|---------------|----|---|
|                         |                            |   |   |      | Lo            | Hi |   |
| Monitor                 | d001                       | Output frequency monitor                | 0.0 to 400.0  | —    | Hz            | —  | — |
|                         | d002                       | Output current monitor                  | 0.0 to 999.9  | —    | A             | —  | — |
|                         | d003                       | Rotation direction monitor              | F(Forward)/o(Stop)/r(Reverse)   | —    | —             | —  | — |
|                         | d004                       | Process variable, PID feedback monitor  | 0.00 to 99.99/100.0 to 999.9/1000. to 9999.                               | —    | —             | —  | — |
|                         | d005                       | Intelligent input terminal status       | ON e.g. :1,2 : ON<br>OFF 3,4,5 : OFF                                      | —    | —             | —  | — |
|                         | d006                       | Intelligent output terminal status      | ON e.g. :11 : ON<br>OFF AL : OFF  | —    | —             | —  | — |
|                         | d007                       | Scaled output frequency monitor         | 0.00 to 99.99/100.0 to 999.9/1000. to 9999./1000 to 9999.(10000 to 99999) | —    | —             | —  | — |
|                         | d013                       | Output voltage monitor                  | 0.0 to 600.0  | —    | V             | —  | — |
|                         | d016                       | Cumulative operation RUN time monitor   | 0. to 9999./1000 to 9999./ [100 to ] [999 (10000 to 99900)]               | —    | hr            | —  | — |
|                         | d017                       | Cumulative power-on time monitor        | 0. to 9999./1000 to 9999  | —    | hr            | —  | — |
|                         | d018                       | Cooling fin temperature monitor         | 0.0 to 200.0  | —    | °C            | —  | — |
|                         | d080                       | Trip counter                            | 0. to 9999.   | —    | events        | —  | — |
|                         | d081                       | Trip monitor 1                          | —   | —    | —             | —  | — |
|                         | d082                       | Trip monitor 2                          | Displays trip event information   | —    | —             | —  | — |
| d083                    | Trip monitor 3             | —                                       | —   | —    | —             | —  |   |
| d102                    | DC bus voltage monitor     | 0.0 to 999.9                            | —   | V    | —             | —  |   |
| d104                    | Electronic thermal monitor | 0.0 to 100.0                            | —   | %    | —             | —  |   |
| Main Profile Parameters | F001                       | Output frequency setting                | 0.0/start freq. to 400.0  | 0.0  | Hz            | ✓  | ✓ |
|                         | F002                       | Acceleration time (1) setting           | 0.01 to 99.99/100.0 to 999.9/1000. to 3000.                               | 10.0 | sec           | ✓  | ✓ |
|                         | F202                       | Acceleration time (2) setting           | 0.01 to 99.99/100.0 to 999.9/1000. to 3000.                               | 10.0 | sec           | ✓  | ✓ |
|                         | F003                       | Deceleration time (1) setting           | 0.01 to 99.99/100.0 to 999.9/1000. to 3000.                               | 10.0 | sec           | ✓  | ✓ |
|                         | F203                       | Deceleration time (2) setting           | 0.01 to 99.99/100.0 to 999.9/1000. to 3000.                               | 10.0 | sec           | ✓  | ✓ |
| F004                    | Keypad Run key routing     | 00(Forward)/01(Reverse)                 | 00  | —    | X             | X  |   |
| Expanded functions      | A--                        | A Group: Standard functions             | —   | —    | —             | —  | — |
|                         | b--                        | b Group: Fine-tuning functions          | —   | —    | —             | —  | — |
|                         | C--                        | C Group: Intelligent terminal functions | —   | —    | —             | —  | — |
|                         | H--                        | H Group: Motor constants functions      | —   | —    | —             | —  | — |
|                         | P--                        | P Group: Expansion Card Functions       | —   | —    | —             | —  | — |

## A Group: Standard functions

✓: Allowed  
X: Not allowed

| Function Code                      | Name                                     | Range  | Default   |        | Unit | Run mode edit |     |
|------------------------------------|--|--|---|--------|------|---------------|-----|
|                                    |  |  | -EF(CE)   | -U(UL) |      | Lo            | Hi  |
| Basic setting                      | A001                                     | Frequency source setting                                   | 00(Keypad potentiometer)/01(Control terminal)/              | 01     | 00   | —             | X X |
|                                    | A201                                     | Frequency source setting, 2nd motor                        | 02(Function F001 setting)/03(RS485)/10(Calculation result)  | 01     | 00   | —             | X X |
|                                    | A002                                     | Run command source setting                                 | 01(Control terminal)/02(Run key on keypad)/03(RS485)        | 01     | 02   | —             | X X |
|                                    | A202                                     | Run command source setting, 2nd motor                      | 01(Control terminal)/02(Run key on keypad)/03(RS485)        | 01     | 02   | —             | X X |
|                                    | A003                                     | Base frequency setting                                     | 30 to maximum freq.   | 50.    | 60.  | Hz            | X X |
|                                    | A203                                     | Base frequency setting, 2nd motor                          | 30 to maximum freq.   | 50.    | 60.  | Hz            | X X |
| Analog input setting               | A004                                     | Maximum frequency setting                                  | 30 to 400   | 50.    | 60.  | Hz            | X X |
|                                    | A204                                     | Maximum frequency setting, 2nd motor                       | 30 to 400   | 50.    | 60.  | Hz            | X X |
|                                    | A005                                     | [AT] selection   | 02(O/VR)/03(OI/VR)/04(O)/05(OI)                             | 02     | 02   | —             | X ✓ |
|                                    | A011                                     | [O]-[L] input active range start frequency                 | 0.0 to maximum freq.  | 0.0    | 0.0  | Hz            | X ✓ |
|                                    | A012                                     | [O]-[L] input active range end frequency                   | 0.0 to maximum freq.  | 0.0    | 0.0  | Hz            | X ✓ |
|                                    | A013                                     | [O]-[L] input active range start voltage                   | 0 to 100  | 0.0    | 0.0  | %             | X ✓ |
| Multi-speed and jogging            | A014                                     | [O]-[L] input active range end voltage                     | 0 to 100  | 100.   | 100. | %             | X ✓ |
|                                    | A015                                     | [O]-[L] input start frequency enable                       | 00(use set value)/01(use 0 Hz)                              | 01     | 01   | —             | X ✓ |
|                                    | A016                                     | External frequency filter time constant                    | 1 to 17   | 8.     | 8.   | —             | X ✓ |
|                                    | A020 - A035                              | Multi-speed frequency setting (0-15)                       | 0.0/start freq. to maximum freq.                            | 0.0    | 0.0  | Hz            | ✓ ✓ |
|                                    | A220                                     | Multi-speed frequency (2nd), setting 2nd motor             | 0.0/start freq. to maximum freq.                            | 0.0    | 0.0  | Hz            | ✓ ✓ |
|                                    | A038                                     | Jog frequency setting                                      | 0.0/start freq. to 9.99                                     | 1.00   | 1.00 | Hz            | ✓ ✓ |
| V/f Characteristic                 | A039                                     | Jog stop mode  | 00(free-run stop)/01(deceleration and stop)/02 (DC braking) | 00     | 00   | —             | X ✓ |
|                                    | A041                                     | Torque boost select  | 00(Manual)/01(Automatic)                                    | 00     | 00   | —             | X X |
|                                    | A241                                     | Torque boost select 2nd motor                              | 00(Manual)/01(Automatic)                                    | 00     | 00   | —             | X X |
|                                    | A042                                     | Manual torque boost value                                  | 0.0 to 20.0   | 1.8    | 1.8  | %             | ✓ ✓ |
|                                    | A242                                     | Manual torque boost value, 2nd motor                       | 0.0 to 20.0   | 0.0    | 0.0  | %             | ✓ ✓ |
|                                    | A043                                     | Manual torque boost frequency adjustment                   | 0.0 to 50.0   | 10.0   | 10.0 | %             | ✓ ✓ |
| DC braking                         | A243                                     | Manual torque boost frequency adjustment, 2nd motor        | 0.0 to 50.0   | 0.0    | 0.0  | %             | ✓ ✓ |
|                                    | A044                                     | V/f characteristic curve selection                         | 00(VC)/01(Reduced torque)/06 (Reduced torque 1)             | 00     | 00   | —             | X X |
|                                    | A244                                     | V/f characteristic curve selection, 2nd motor              | 00(VC)/01(Reduced torque)/06 (Reduced torque 1)             | 00     | 00   | —             | X X |
|                                    | A045                                     | V/f gain setting   | 20 to 100   | 100.   | 100. | %             | X ✓ |
|                                    | A245                                     | V/f gain setting, 2nd motor                                | 20 to 100   | 100.   | 100. | %             | X ✓ |
|                                    | A051                                     | DC braking enable  | 00(Disable)/01(Enable)/02(Frequency detection)              | 00     | 00   | —             | X ✓ |
| Frequency limit and jump frequency | A052                                     | DC braking frequency setting                               | 0.0 to 60.0   | 0.5    | 0.5  | Hz            | X ✓ |
|                                    | A053                                     | DC braking wait time                                       | 0.0 to 5.0  | 0.0    | 0.0  | sec           | X ✓ |
|                                    | A054                                     | DC braking force during deceleration                       | 0. to 100.  | 0.     | 0.   | %             | X ✓ |
|                                    | A055                                     | DC braking time for deceleration                           | 0.0 to 60.0   | 0.0    | 0.0  | sec           | X ✓ |
|                                    | A056                                     | DC braking / edge or level detection for [DB] input        | 00(Edge)/01(Level)  | 01     | 01   | —             | X ✓ |
|                                    | A061                                     | Frequency upper limit setting                              | 0.0/Freq. lower limit setting to maximum freq.              | 0.0    | 0.0  | Hz            | X ✓ |
| A261                               | Frequency upper limit setting, 2nd motor | 0.0/Freq. lower limit setting (2nd) to maximum freq. (2nd) | 0.0   | 0.0    | Hz   | X ✓           |     |
| A062                               | Frequency lower limit setting            | 0.0/Start freq. to freq. upper limit setting               | 0.0   | 0.0    | Hz   | X ✓           |     |
| A262                               | Frequency lower limit setting, 2nd motor | 0.0/Start freq. (2nd) to freq. upper limit setting (2nd)   | 0.0   | 0.0    | Hz   | X ✓           |     |
| A063                               | Jump (center) frequency setting 1        | 0.0 to 400.  | 0.0   | 0.0    | Hz   | X ✓           |     |
| A064                               | Jump (hysteresis) frequency setting 1    | 0.0 to 10.0  | 0.5   | 0.5    | Hz   | X ✓           |     |
| A065                               | Jump (center) frequency setting 2        | 0.0 to 400.  | 0.0   | 0.0    | Hz   | X ✓           |     |
| A066                               | Jump (hysteresis) frequency setting 2    | 0.0 to 10.0  | 0.5   | 0.5    | Hz   | X ✓           |     |
| A067                               | Jump (center) frequency setting 3        | 0.0 to 400.  | 0.0   | 0.0    | Hz   | X ✓           |     |
| A068                               | Jump (hysteresis) frequency setting 3    | 0.0 to 10.0  | 0.5   | 0.5    | Hz   | X ✓           |     |



# Function List

## A Group: Standard functions

✓: Allowed  
✗: Not allowed

| Function Code                         | Name                                | Range   | Default  |        | Unit | Run mode edit |    |
|---------------------------------------|-------------------------------------|---|--|--------|------|---------------|----|
|                                       |                                     |   | -EF(CE)  | -U(UL) |      | Lo            | Hi |
| PID Control                           | A071                                | PID Enable  | 00(Disable)/01(Enable)   |        | -    | ✗             | ✓  |
|                                       | A072                                | PID proportional gain                                   | 0.2 to 5.0   |        | -    | ✓             | ✓  |
|                                       | A073                                | PID integral time constant                              | 0.0 to 150.0   |        | sec  | ✓             | ✓  |
|                                       | A074                                | PID derivative time constant                            | 0.00 to 100.0  |        | sec  | ✓             | ✓  |
|                                       | A075                                | PV scale conversion                                     | 0.01 to 99.99  |        | -    | ✗             | ✓  |
|                                       | A076                                | PV source setting                                       | 00([O] terminal)/01([O] terminal)/02(RS485)/10(Calculation result)     |        | -    | ✗             | ✓  |
|                                       | A077                                | Reverse PID action                                      | 00(OFF)/01(ON)   |        | -    | ✗             | ✓  |
|                                       | A078                                | PID output limit  | 0.0 to 100.0   |        | %    | ✗             | ✓  |
| AVR function                          | A081                                | AVR function select                                     | 00(Enable)/01(Disable)/02(Enabled except during deceleration)          |        | -    | ✗             | ✗  |
|                                       | A082                                | AVR voltage select                                      | 200V class: 200/215/220/230/240<br>400V class: 380/400/415/440/460/480 |        | V    | ✗             | ✗  |
| Automatic Energy Saving               | A085                                | Operation mode selection                                | 00(Normal)/01(Energy-saver)  |        | -    | ✗             | ✗  |
|                                       | A086                                | Energy saving mode tuning                               | 0.0 to 100.0   |        | sec  | ✗             | ✗  |
| Operation mode and acc./dec. function | A092                                | Acceleration (2) time setting                           | 0.01 to 99.99/100.0 to 999.9/1000. to 3000.                            |        | sec  | ✓             | ✓  |
|                                       | A292                                | Acceleration (2) time setting, 2nd motor                | 0.01 to 99.99/100.0 to 999.9/1000. to 3000.                            |        | sec  | ✓             | ✓  |
|                                       | A093                                | Deceleration (2) time setting                           | 0.01 to 99.99/100.0 to 999.9/1000. to 3000.                            |        | sec  | ✓             | ✓  |
|                                       | A293                                | Deceleration (2) time setting, 2nd motor                | 0.01 to 99.99/100.0 to 999.9/1000. to 3000.                            |        | sec  | ✓             | ✓  |
|                                       | A094                                | Select method to switch to Acc2/Dec2 profile            | 00(2CH from input terminal)/01(transition freq.)                       |        | -    | ✗             | ✗  |
|                                       | A294                                | Select method to switch to Acc2/Dec2 profile, 2nd motor | 00(2CH from input terminal)/01(transition freq.)                       |        | -    | ✗             | ✗  |
|                                       | A095                                | Acc1 to Acc2 frequency transition point                 | 0.0 to 400.0   |        | Hz   | ✗             | ✗  |
|                                       | A295                                | Acc1 to Acc2 frequency transition point, 2nd motor      | 0.0 to 400.0   |        | Hz   | ✗             | ✗  |
|                                       | A096                                | Dec1 to Dec2 frequency transition point                 | 0.0 to 400.0   |        | Hz   | ✗             | ✗  |
|                                       | A296                                | Dec1 to Dec2 frequency transition point, 2nd motor      | 0.0 to 400.0   |        | Hz   | ✗             | ✗  |
| External freq. tuning                 | A097                                | Acceleration curve selection                            | 00(Linear)/01(S-curve)   |        | -    | ✗             | ✗  |
|                                       | A098                                | Deceleration curve selection                            | 00(Linear)/01(S-curve)   |        | -    | ✗             | ✗  |
|                                       | A101                                | [O]-[L] input active range start frequency              | 0.0 to 400.0   |        | Hz   | ✗             | ✓  |
|                                       | A102                                | [O]-[L] input active range end frequency                | 0.0 to 400.0   |        | Hz   | ✗             | ✓  |
|                                       | A103                                | [O]-[L] input active range start current                | 0. to 100.   |        | %    | ✗             | ✓  |
| Frequency calculation                 | A104                                | [O]-[L] input active range end current                  | 0. to 100.   |        | %    | ✗             | ✓  |
|                                       | A105                                | [O]-[L] input start frequency enable                    | 00(Use setting value)/01(0Hz)  |        | -    | ✗             | ✓  |
|                                       | A141                                | A input select for calculate function                   | 00(Digital operator)/01(Keypad potentiometer)                          |        | -    | ✗             | ✓  |
|                                       | A142                                | B input select for calculate function                   | 02(O input)/03(OI input)/04(RS485)                                     |        | -    | ✗             | ✓  |
|                                       | A143                                | Calculation symbol                                      | 00(A141+A142)/01(A141-A142)/02(A141*A142)                              |        | -    | ✗             | ✓  |
|                                       | A145                                | ADD frequency   | 0.0 to 400.0   |        | Hz   | ✓             | ✓  |
|                                       | A146                                | ADD direction select                                    | 00(Plus)/01(Minus)   |        | -    | ✗             | ✓  |
|                                       | A151                                | Pot. input active range start frequency                 | 0.0 to 400.0   |        | Hz   | ✗             | ✓  |
|                                       | A152                                | Pot. input active range end frequency                   | 0.0 to 400.0   |        | Hz   | ✗             | ✓  |
|                                       | A153                                | Pot. input active range start current                   | 0.0 to 100.0   |        | %    | ✗             | ✓  |
| A154                                  | Pot. input active range end current | 0.0 to 100.0  |  | %      | ✗    | ✓             |    |
| A155                                  | Pot.input start frequency enable    | 00(Use effect (A151 value))/01(Use 0Hz)                 |  | -      | ✗    | ✓             |    |

## b Group: Fine-tuning functions

✓: Allowed  
✗: Not allowed

| Function Code                             | Name | Range   | Default   |        | Unit | Run mode edit |    |
|---|------|---|---|--------|------|---------------|----|
|   |      |   | -EF(CE)   | -U(UL) |      | Lo            | Hi |
| Restart after instantaneous power failure | b001 | Selection of automatic restart mode                             | 00(Alarm output)/01(Restart at 0Hz)/02(Resume after freq. matching)/03(Resume freq. matching then trip)   |        | -    | ✗             | ✓  |
|   | b002 | Allowable under-voltage power failure time                      | 0.3 to 25.0   |        | sec  | ✗             | ✓  |
|   | b003 | Retry wait time before motor restart                            | 0.3 to 100.0  |        | sec  | ✗             | ✓  |
|   | b004 | Instantaneous power failure / under-voltage trip alarm enable   | 00(Disable)/01(Enable)  |        | -    | ✗             | ✓  |
|   | b005 | Number of restarts on power failure / under-voltage trip events | 00(Restart 16 times)/01(Always restart)   |        | -    | ✗             | ✓  |
|   | b011 | Start frequency to be used in case of frequency pull-in restart | 00(frequency at previous shutoff)/01(Max. Hz)/02(Set frequency)   |        | -    | ✗             | ✗  |
|   | b012 | Electronic thermal setting                                      | 0.2*Rated current to 1.0*Rated current  |        | A    | ✗             | ✓  |
|   | b212 | Electronic thermal setting, 2nd motor                           | 0.2*Rated current to 1.0*Rated current  |        | A    | ✗             | ✓  |
| Overload restriction                      | b013 | Electronic thermal characteristic                               | 00(Reduced torque)/01(Constant torque)/02(Reduced torque 2)   |        | -    | ✗             | ✓  |
|   | b213 | Electronic thermal characteristic, 2nd motor                    | 00(Reduced torque)/01(Constant torque)/02(Reduced torque 2)   |        | -    | ✗             | ✓  |
|   | b021 | Overload restriction operation mode                             | 00(Disable)/01(Enable)/02(Enable for during acceleration)   |        | -    | ✗             | ✓  |
|   | b221 | Overload restriction operation mode, 2nd motor                  | 00(Disable)/01(Enable)/02(Enable for during acceleration)   |        | -    | ✗             | ✓  |
|   | b022 | Overload restriction setting                                    | 0.2*Rated current to 1.5*Rated current  |        | A    | ✗             | ✓  |
|   | b222 | Overload restriction setting, 2nd motor                         | 0.2*Rated current to 1.5*Rated current  |        | A    | ✗             | ✓  |
|   | b023 | Deceleration rate at overload restriction                       | 1.0 to 3000.0   |        | sec  | ✗             | ✓  |
|   | b223 | Deceleration rate at overload restriction, 2nd motor            | 1.0 to 3000.0   |        | sec  | ✗             | ✓  |
|   | b028 | Overload restriction source selection                           | 00(b022/b222 setting level)/01([O]-[L] analog input)  |        | -    | ✗             | ✓  |
|   | b228 | Overload restriction source selection, 2nd motor                | 00(b022/b222 setting level)/01([O]-[L] analog input)  |        | -    | ✗             | ✓  |
| Lock                                      | b029 | Deceleration rate of frequency pull-in restart                  | 0.1 to 3000.0   |        | sec  | ✗             | ✗  |
|   | b030 | Current level of frequency pull-in restart                      | 0.2*Rated current to 2.0*Rated current  |        | A    | ✗             | ✗  |
| Others                                    | b031 | Software lock mode selection                                    | 00([SFT] input blocks all edits)/01([SFT] input blocks edits except F001 and Multispeed parameters)/02(No access to edits except F001 and Multi-speed parameters)/10(High-level access, including b031) |        | -    | ✗             | ✓  |
|   | b050 | Selection of the non stop operation                             | 00(Disabled)/01(Enabled stop)/02(Enabled restart)   |        | -    | ✗             | ✗  |
|   | b051 | Non stop operation start voltage setting                        | 0.0 to 1000.0   |        | V    | ✗             | ✗  |
|   | b052 | OV-LAD Stop level of non stop operation setting                 | 0.0 to 1000.0   |        | V    | ✗             | ✗  |
|   | b053 | Deceleration time of non stop operation setting                 | 0.01 to 3000  |        | sec  | ✗             | ✗  |
|   | b054 | Frequency width of quick deceleration setting                   | 0.0 to 10.0   |        | Hz   | ✗             | ✗  |
|   | b055 | DC bus AVR P-gain   | 0.2 to 5.0  |        | -    | ✗             | ✗  |
|   | b056 | DC bus AVR I-time   | 0.0 to 150.0  |        | sec  | ✗             | ✗  |
|   | b057 | DC bus AVR D-time   | 0.0 to 100.0  |        | sec  | ✗             | ✗  |
|   | b080 | [AM] terminal analog meter adjustment                           | 0. to 255.  |        | -    | ✓             | ✓  |
|   | b082 | Start frequency adjustment                                      | 0.5 to 9.9  |        | Hz   | ✗             | ✓  |
|   | b083 | Carrier frequency setting                                       | 2.0 to 12.0   |        | kHz  | ✗             | ✗  |

# Function List

| Function Code | Name | Range  | Default  |         | Unit    | Run mode edit |    |   |
|---------------|------|--|--|---------|---------|---------------|----|---|
|               |      |  | -EF(CE)  | -U(UL)  |         | Lo            | Hi |   |
| Others        | b084 | Initialization mode (parameters or trip history) | 00(Trip history clear)/01(Parameter initialization)/02(Trip history clear and parameter initialization)  | 00      | 00      | –             | X  | X |
|               | b085 | Country code for initialization                  | 00(JP)/01(CE)/02(US)   | 01      | 02      | –             | X  | X |
|               | b086 | Frequency scaling conversion factor              | 0.1 to 99.9  | 1.0     | 1.0     | –             | ✓  | ✓ |
|               | b087 | STOP key enable                                  | 00(Enable)/01(Disable)   | 00      | 00      | –             | X  | ✓ |
|               | b088 | Restart mode after FRS                           | 00(Restart from 0Hz)/01(Restart with frequency detection)  | 00      | 00      | –             | X  | ✓ |
|               | b089 | Monitor display select for networked inverter    | 01(Output frequency)/02(Output current)/03(Rotation direction)/04(PV, PID feedback)/05(Input terminal status)/06(Output terminal status)/07(Scaled output frequency) | 01      | 01      | –             | ✓  | ✓ |
|               | b091 | Stop mode selection                              | 00(Deceleration and stop)/01(Free-run stop)  | 00      | 00      | –             | X  | X |
|               | b092 | Cooling fan control (see note below)             | 00(Always ON)/01(ON during RUN, OFF during STOP)/02(Temperature controlled)  | 00      | 00      | –             | X  | X |
|               | b130 | Over-voltage LADSTOP enable                      | 00(Disable)/01(Enable)   | 00      | 00      | –             | X  | ✓ |
|               | b131 | Over-voltage LADSTOP level                       | 330 to 395V/660 to 790V  | 380/760 | 380/760 | V             | ✓  | ✓ |
|               | b133 | DC bus AVR selection                             | 00(Disabled)/01(Enabled)   | 00      | 00      | –             | X  | ✓ |
|               | b134 | Threshold voltage of DC bus AVR setting          | 330 to 395V/660 to 790V  | 380/760 | 380/760 | V             | X  | ✓ |
|               | b140 | Over-current trip suppression                    | 00(Disable)/01(Enable)   | 01      | 01      | –             | X  | ✓ |
|               | b150 | Carrier mode                                     | 00(Disable)/01(Enable)   | 00      | 00      | –             | X  | ✓ |
|               | b151 | Quick start enable                               | 00(Disable)/01(Enable)   | 00      | 00      | –             | ✓  | ✓ |

## C Group: Intelligent terminal functions

[✓: Allowed  
[X: Not allowed]

| Function Code              | Name                             | Range                                      | Default  |               | Unit          | Run mode edit |    |   |
|----------------------------|----------------------------------|--|--|---------------|---------------|---------------|----|---|
|                            |                                  |  | -EF(CE)  | -U(UL)        |               | Lo            | Hi |   |
| Intelligent input terminal | C001                             | Terminal [1] function                      | 00(FW:Forward, 01(RV:Reverse), 02-05(CF1-CF4:Multispeed command), 06(JG:Jogging), 07(DB:External DC braking), 08(SET:Second motor constants setting), 09(2CH:Second accel./decel.), 11(FRS:Free-run stop), 12(EXT:External trip), 13(USP:Unattended start protection), 15(SFT:Software lock), 16(AT:Analog input selection), 18(RS:Reset), 19(PTC:Thermistor input), 20(STA:3-wire start), 21(STP:3-wire stop), 22(F/R:3-wire fwd./rev.), 23(PID:PID On/Off), 24(PIDC:PID reset), 27(UP:Remote-controlled accel.), 28(DWN:Remote-controlled decel.), 29(UDC:Remote-controlled data clearing), 31(OPE:Operator control), 50(ADD: Frequency setpoint), 51(F-TM: Force terminal enable), 52(RDY: Quick Start Enable), 53(S-ST: Special-Set (select) 2nd Motor Data), 64(EMR:Emergency stop), 255(NO:Not selected) | 00            | 00            | –             | X  | X |
|                            | C201                             | Terminal [1] function, 2nd motor           | 06(JG:Jogging), 07(DB:External DC braking), 08(SET:Second motor constants setting), 09(2CH:Second accel./decel.), 11(FRS:Free-run stop), 12(EXT:External trip), 13(USP:Unattended start protection), 15(SFT:Software lock), 16(AT:Analog input selection), 18(RS:Reset), 19(PTC:Thermistor input), 20(STA:3-wire start), 21(STP:3-wire stop), 22(F/R:3-wire fwd./rev.), 23(PID:PID On/Off), 24(PIDC:PID reset), 27(UP:Remote-controlled accel.), 28(DWN:Remote-controlled decel.), 29(UDC:Remote-controlled data clearing), 31(OPE:Operator control), 50(ADD: Frequency setpoint), 51(F-TM: Force terminal enable), 52(RDY: Quick Start Enable), 53(S-ST: Special-Set (select) 2nd Motor Data), 64(EMR:Emergency stop), 255(NO:Not selected)   | 00            | 00            | –             | X  | X |
|                            | C002                             | Terminal [2] function                      | 00(FW:Forward, 01(RV:Reverse), 02-05(CF1-CF4:Multispeed command), 06(JG:Jogging), 07(DB:External DC braking), 08(SET:Second motor constants setting), 09(2CH:Second accel./decel.), 11(FRS:Free-run stop), 12(EXT:External trip), 13(USP:Unattended start protection), 15(SFT:Software lock), 16(AT:Analog input selection), 18(RS:Reset), 19(PTC:Thermistor input), 20(STA:3-wire start), 21(STP:3-wire stop), 22(F/R:3-wire fwd./rev.), 23(PID:PID On/Off), 24(PIDC:PID reset), 27(UP:Remote-controlled accel.), 28(DWN:Remote-controlled decel.), 29(UDC:Remote-controlled data clearing), 31(OPE:Operator control), 50(ADD: Frequency setpoint), 51(F-TM: Force terminal enable), 52(RDY: Quick Start Enable), 53(S-ST: Special-Set (select) 2nd Motor Data), 64(EMR:Emergency stop), 255(NO:Not selected) | 01            | 01            | –             | X  | X |
|                            | C202                             | Terminal [2] function, 2nd motor           | 06(JG:Jogging), 07(DB:External DC braking), 08(SET:Second motor constants setting), 09(2CH:Second accel./decel.), 11(FRS:Free-run stop), 12(EXT:External trip), 13(USP:Unattended start protection), 15(SFT:Software lock), 16(AT:Analog input selection), 18(RS:Reset), 19(PTC:Thermistor input), 20(STA:3-wire start), 21(STP:3-wire stop), 22(F/R:3-wire fwd./rev.), 23(PID:PID On/Off), 24(PIDC:PID reset), 27(UP:Remote-controlled accel.), 28(DWN:Remote-controlled decel.), 29(UDC:Remote-controlled data clearing), 31(OPE:Operator control), 50(ADD: Frequency setpoint), 51(F-TM: Force terminal enable), 52(RDY: Quick Start Enable), 53(S-ST: Special-Set (select) 2nd Motor Data), 64(EMR:Emergency stop), 255(NO:Not selected)   | 01            | 01            | –             | X  | X |
|                            | C003                             | Terminal [3] function                      | 00(FW:Forward, 01(RV:Reverse), 02-05(CF1-CF4:Multispeed command), 06(JG:Jogging), 07(DB:External DC braking), 08(SET:Second motor constants setting), 09(2CH:Second accel./decel.), 11(FRS:Free-run stop), 12(EXT:External trip), 13(USP:Unattended start protection), 15(SFT:Software lock), 16(AT:Analog input selection), 18(RS:Reset), 19(PTC:Thermistor input), 20(STA:3-wire start), 21(STP:3-wire stop), 22(F/R:3-wire fwd./rev.), 23(PID:PID On/Off), 24(PIDC:PID reset), 27(UP:Remote-controlled accel.), 28(DWN:Remote-controlled decel.), 29(UDC:Remote-controlled data clearing), 31(OPE:Operator control), 50(ADD: Frequency setpoint), 51(F-TM: Force terminal enable), 52(RDY: Quick Start Enable), 53(S-ST: Special-Set (select) 2nd Motor Data), 64(EMR:Emergency stop), 255(NO:Not selected) | 02            | 16            | –             | X  | X |
|                            | C203                             | Terminal [3] function, 2nd motor           | 06(JG:Jogging), 07(DB:External DC braking), 08(SET:Second motor constants setting), 09(2CH:Second accel./decel.), 11(FRS:Free-run stop), 12(EXT:External trip), 13(USP:Unattended start protection), 15(SFT:Software lock), 16(AT:Analog input selection), 18(RS:Reset), 19(PTC:Thermistor input), 20(STA:3-wire start), 21(STP:3-wire stop), 22(F/R:3-wire fwd./rev.), 23(PID:PID On/Off), 24(PIDC:PID reset), 27(UP:Remote-controlled accel.), 28(DWN:Remote-controlled decel.), 29(UDC:Remote-controlled data clearing), 31(OPE:Operator control), 50(ADD: Frequency setpoint), 51(F-TM: Force terminal enable), 52(RDY: Quick Start Enable), 53(S-ST: Special-Set (select) 2nd Motor Data), 64(EMR:Emergency stop), 255(NO:Not selected)   | 02            | 16            | –             | X  | X |
|                            | C004                             | Terminal [4] function                      | 00(FW:Forward, 01(RV:Reverse), 02-05(CF1-CF4:Multispeed command), 06(JG:Jogging), 07(DB:External DC braking), 08(SET:Second motor constants setting), 09(2CH:Second accel./decel.), 11(FRS:Free-run stop), 12(EXT:External trip), 13(USP:Unattended start protection), 15(SFT:Software lock), 16(AT:Analog input selection), 18(RS:Reset), 19(PTC:Thermistor input), 20(STA:3-wire start), 21(STP:3-wire stop), 22(F/R:3-wire fwd./rev.), 23(PID:PID On/Off), 24(PIDC:PID reset), 27(UP:Remote-controlled accel.), 28(DWN:Remote-controlled decel.), 29(UDC:Remote-controlled data clearing), 31(OPE:Operator control), 50(ADD: Frequency setpoint), 51(F-TM: Force terminal enable), 52(RDY: Quick Start Enable), 53(S-ST: Special-Set (select) 2nd Motor Data), 64(EMR:Emergency stop), 255(NO:Not selected) | 03            | 13            | –             | X  | X |
|                            | C204                             | Terminal [4] function, 2nd motor           | 06(JG:Jogging), 07(DB:External DC braking), 08(SET:Second motor constants setting), 09(2CH:Second accel./decel.), 11(FRS:Free-run stop), 12(EXT:External trip), 13(USP:Unattended start protection), 15(SFT:Software lock), 16(AT:Analog input selection), 18(RS:Reset), 19(PTC:Thermistor input), 20(STA:3-wire start), 21(STP:3-wire stop), 22(F/R:3-wire fwd./rev.), 23(PID:PID On/Off), 24(PIDC:PID reset), 27(UP:Remote-controlled accel.), 28(DWN:Remote-controlled decel.), 29(UDC:Remote-controlled data clearing), 31(OPE:Operator control), 50(ADD: Frequency setpoint), 51(F-TM: Force terminal enable), 52(RDY: Quick Start Enable), 53(S-ST: Special-Set (select) 2nd Motor Data), 64(EMR:Emergency stop), 255(NO:Not selected)   | 03            | 13            | –             | X  | X |
|                            | C005                             | Terminal [5] function                      | 00(FW:Forward, 01(RV:Reverse), 02-05(CF1-CF4:Multispeed command), 06(JG:Jogging), 07(DB:External DC braking), 08(SET:Second motor constants setting), 09(2CH:Second accel./decel.), 11(FRS:Free-run stop), 12(EXT:External trip), 13(USP:Unattended start protection), 15(SFT:Software lock), 16(AT:Analog input selection), 18(RS:Reset), 19(PTC:Thermistor input), 20(STA:3-wire start), 21(STP:3-wire stop), 22(F/R:3-wire fwd./rev.), 23(PID:PID On/Off), 24(PIDC:PID reset), 27(UP:Remote-controlled accel.), 28(DWN:Remote-controlled decel.), 29(UDC:Remote-controlled data clearing), 31(OPE:Operator control), 50(ADD: Frequency setpoint), 51(F-TM: Force terminal enable), 52(RDY: Quick Start Enable), 53(S-ST: Special-Set (select) 2nd Motor Data), 64(EMR:Emergency stop), 255(NO:Not selected) | 18            | 18            | –             | X  | X |
|                            | C205                             | Terminal [5] function, 2nd motor           | 06(JG:Jogging), 07(DB:External DC braking), 08(SET:Second motor constants setting), 09(2CH:Second accel./decel.), 11(FRS:Free-run stop), 12(EXT:External trip), 13(USP:Unattended start protection), 15(SFT:Software lock), 16(AT:Analog input selection), 18(RS:Reset), 19(PTC:Thermistor input), 20(STA:3-wire start), 21(STP:3-wire stop), 22(F/R:3-wire fwd./rev.), 23(PID:PID On/Off), 24(PIDC:PID reset), 27(UP:Remote-controlled accel.), 28(DWN:Remote-controlled decel.), 29(UDC:Remote-controlled data clearing), 31(OPE:Operator control), 50(ADD: Frequency setpoint), 51(F-TM: Force terminal enable), 52(RDY: Quick Start Enable), 53(S-ST: Special-Set (select) 2nd Motor Data), 64(EMR:Emergency stop), 255(NO:Not selected)   | 18            | 18            | –             | X  | X |
| C011-C015                  | Terminal [1] to [5] active state | 00(NO)/01(NC)                              | 00   | 00*           | –             | X             | X  |   |
| Intelligent input terminal | C021                             | Terminal [11] function                     | 00(RUN:run signal), 01(FA1:Frequency arrival type 1 - constant speed), 02(FA2:Frequency arrival type 2 - over-frequency), 03(OL:overload advance notice signal), 04(OD:Output deviation for PID control), 05(AL:alarm signal), 06(DC:Wire brake detect on analog input), 07(FBV: Feedback voltage comparison), 08(NDC: Network Disconnection), 09(LOG: Logic operation result), 10(ODC: Option Card Detection Signal), 43(LOC:Low load detection)  | 01            | 01            | –             | X  | X |
|                            | C026                             | Alarm relay function                       | 00(Output frequency)/01(Output current)  | 05            | 05            | –             | X  | X |
|                            | C028                             | [AM] signal selection                      | 00(NO)/01(NC)  | 00            | 00            | –             | X  | ✓ |
|                            | C031                             | Terminal [11] active state                 | 00(NO)/01(NC)  | 00            | 00            | –             | X  | X |
|                            | C036                             | Alarm relay active state                   | 00(NO)/01(NC)  | 01            | 01            | –             | X  | X |
|                            | C038                             | Output mode of low load detection signal   | 00(Disabled)/01(During acceleration, deceleration and constant speed)/02(During constant speed only)   | 01            | 01            | –             | X  | ✓ |
|                            | C039                             | Low load detection level                   | 0.0 to 2.0*Rated current   | Rated current | Rated current | A             | X  | ✓ |
|                            | C041                             | Overload level setting                     | 0.0 to 2.0*Rated current   | Rated current | Rated current | A             | X  | ✓ |
|                            | C241                             | Overload level setting, 2nd motor          | 0.0*Rated current to 2.0*Rated current   | Rated current | Rated current | A             | X  | ✓ |
|                            | C042                             | Frequency arrival setting for acceleration | 0.0 to 400.0   | 0.0           | 0.0           | Hz            | X  | ✓ |
|                            | C043                             | Frequency arrival setting for deceleration | 0.0 to 400.0   | 0.0           | 0.0           | Hz            | X  | ✓ |
|                            | C044                             | PID deviation level setting                | 0.0 to 100.0   | 3.0           | 3.0           | %             | X  | ✓ |
|                            | C052                             | Feedback comparison upper level            | 0.0 to 100.0   | 100           | 100           | %             | X  | ✓ |
|                            | C053                             | Feedback comparison lower level            | 0.0 to 100.0   | 0.0           | 0.0           | %             | X  | ✓ |
| Serial communication       | C070                             | SELECTION OF OPE/MODBUS                    | 02(OPE or option)/03(485)  | 02            | 02            | –             | X  | ✓ |
|                            | C071                             | Communication speed selection              | 04(4800bps)/05(9600bps)/06(19200bps)   | 06            | 04            | –             | X  | ✓ |
|                            | C072                             | Node allocation                            | 1. to 32.  | 1.            | 1.            | –             | X  | ✓ |
|                            | C074                             | Communication parity selection             | 00(No parity)/01(Even parity)/02(Odd parity)   | 00            | 00            | –             | X  | ✓ |
|                            | C075                             | Communication stop bit selection           | 1(1-bit)/2(2-bit)  | 1             | 1             | bit           | X  | ✓ |
|                            | C076                             | Communication error mode                   | 00(Trip)/01(Trip after deceleration stop)/02(Disable)/03(FRS)/04(Deceleration stop)  | 02            | 02            | –             | X  | ✓ |
|                            | C077                             | Communication error time                   | 0.00 to 99.99  | 0.00          | 0.00          | sec           | X  | ✓ |
| Analog meter setting       | C078                             | Communication wait time                    | 0. to 1000.  | 0.            | 0.            | msec          | X  | ✓ |
|                            | C081                             | [O] input span calibration                 | 0. to 200.   | 100.          | 100.          | %             | ✓  | ✓ |
|                            | C082                             | [O] input span calibration                 | 0. to 200.   | 100.          | 100.          | %             | ✓  | ✓ |
|                            | C086                             | [AM] terminal offset tuning                | 0.0 to 10.0  | 0.0           | 0.0           | V             | ✓  | ✓ |
| Others                     | C091                             | Reserved (for factory adjustment)          | 00 (must not be changed)   | 00            | 00            | –             | ✓  | ✓ |
|                            | C101                             | Up/Down memory mode selection              | 00(Clear last frequency)/01(Keep last frequency adjusted by UP/DWN)  | 00            | 00            | –             | X  | ✓ |
|                            | C102                             | Reset mode selection                       | 00(Cancel trip state at input signal ON transition)/ 01(Cancel trip state at signal OFF transition)/ 02(Cancel trip state at input signal ON transition)   | 00            | 00            | –             | X  | ✓ |
|                            | C141                             | Input A select for logic output 1          | 00(RUN)/01(FA1)/02(FA2)/03(OL)/04(OD)  | 00            | 00            | –             | X  | X |
|                            | C142                             | Input A select for logic output 2          | 05(AL)/06(Dc)/07(FBV)/08(NDC)/10(ODC)/43(LOC)  | 01            | 01            | –             | X  | X |
|                            | C143                             | Logic function select                      | 00(AND)/01(OR)/02(XOR)   | 00            | 00            | –             | X  | X |
|                            | C144                             | ON delay time, output terminal 11          | 0.0 to 100.0   | 0.0           | 0.0           | sec           | X  | ✓ |
|                            | C145                             | OFF delay time, output terminal 11         | 0.0 to 100.0   | 0.0           | 0.0           | sec           | X  | ✓ |
|                            | C148                             | ON delay time, relay                       | 0.0 to 100.0   | 0.0           | 0.0           | sec           | X  | ✓ |
|                            | C149                             | OFF delay time, relay                      | 0.0 to 100.0   | 0.0           | 0.0           | sec           | X  | ✓ |

Note: C014: 01 for UL version.

## H Group: Motor constants functions

[✓: Allowed  
[X: Not allowed]

| Function Code            | Name | Range                                   | Default                                   |             | Unit        | Run mode edit |    |   |
|--------------------------|------|---|---|-------------|-------------|---------------|----|---|
|                          |      |   | -EF(CE)                                   | -U(UL)      |             | Lo            | Hi |   |
| Motor constants and gain | H003 | Motor capacity, 1st motor               | 0.2/0.4/0.55/0.75/1.1/1.5/2.2/3.0/4.0/5.5 | Factory set | Factory set | kW            | X  | X |
|                          | H203 | Motor capacity, 2nd motor               |   | set         | set         | kW            | X  | X |
|                          | H004 | Motor poles setting, 1st motor          | 2/4/6/8                                   | 4           | 4           | poles         | X  | X |
|                          | H204 | Motor poles setting, 2nd motor          |   | 4           | 4           | poles         | X  | X |
|                          | H006 | Motor stabilization constant, 1st motor | 0. to 255.                                | 100         | 100         | –             | ✓  | ✓ |
|                          | H206 | Motor stabilization constant, 2nd motor |   | 100         | 100         | –             | ✓  | ✓ |

# Function List

## P Group: Expansion Card Functions

✓: Allowed  
✗: Not allowed

| Function Code  | Name                                | Range                                 | Default  |        | Unit | Run mode edit |    |   |
|----------------|-------------------------------------|---------------------------------------|--|--------|------|---------------|----|---|
|                |                                     |                                       | -EF(CE)  | -U(UL) |      | Lo            | Hi |   |
| Option Setting | P044                                | Network comm watchdog timer           | 0.00 to 99.99  | 1.00   | 1.00 | sec.          | ✗  | ✗ |
|                | P045                                | Inverter action on network comm error | 00(Trip (Error Code E70))<br>01(Decelerate to stop and trip (Error Code E70))<br>02(Hold last speed), 03(Free run stop), 04(Decelerate and stop) | 01     | 01   | -             | ✗  | ✗ |
|                | P046                                | Polled I/O output instance number     | 20/21/100  | 21     | 21   | -             | ✗  | ✗ |
|                | P047                                | Polled I/O input instance number      | 70/71/101  | 71     | 71   | -             | ✗  | ✗ |
|                | P048                                | Inverter action on network idle mode  | 00(Trip (Error Code E70))<br>01(Decelerate to stop and trip (Error Code E70))<br>02(Hold last speed), 03(Free run stop), 04(Decelerate and stop) | 01     | 01   | -             | ✗  | ✗ |
| P049           | Network motor poles setting for RPM | 00 to 38                              | 0  | 0      | -    | ✗             | ✗  |   |

Note: The "P" Group parameters do not appear in the parameter list shown on the keypad display unless the expansion card is installed on the inverter.

# Protective Functions

## Error Codes

| Name                    | Cause(s)  | Display on digital operator                 | Display on remote operator/copy unit       |
|-------------------------|---|---|--|
| Over current            | The inverter output was short-circuited, or the motor shaft is locked or has a heavy load. These conditions cause excessive current for the inverter, so the inverter output is turned OFF.                         | While at constant speed                     | <input type="text" value="E 01"/> OC.Drive |
|                         |   | During deceleration                         | <input type="text" value="E 02"/> OC.Decel |
|                         |   | During acceleration                         | <input type="text" value="E 03"/> OC.Accel |
|                         |   | Others                                      | <input type="text" value="E 04"/> Over.C   |
| Overload protection *1  | When a motor overload is detected by the electronic thermal function, the inverter trips and turns OFF its output.  | <input type="text" value="E 05"/> Over.L    | <input type="text" value="Over.L"/>        |
| Over voltage protection | When the DC bus voltage exceeds a threshold, due to regenerative energy from the motor.   | <input type="text" value="E 07"/> Over.V    | <input type="text" value="Over.V"/>        |
| EEPROM error *2,3       | When the built-in EEPROM memory has problems due to noise or excessive temperature, the inverter trips and turns OFF its output to the motor.   | <input type="text" value="E 08"/> EEPROM    | <input type="text" value="EEPROM"/>        |
| Under-voltage error     | A decrease of internal DC bus voltage below a threshold results in a control circuit fault. This condition can also generate excessive motor heat or cause low torque. The inverter trips and turns OFF its output. | <input type="text" value="E 09"/> Under.V   | <input type="text" value="Under.V"/>       |
| CPU error               | A malfunction in the built-in CPU has occurred, so the inverter trips and turns OFF its output to the motor.  | <input type="text" value="E 11"/> CPU       | <input type="text" value="CPU"/>           |
| External trip           | A signal on an intelligent input terminal configured as EXT has occurred. The inverter trips and turns OFF the output to the motor.   | <input type="text" value="E 12"/> EXTERNAL  | <input type="text" value="EXTERNAL"/>      |
| USP *4                  | When the Unattended Start Protection (USP) is enabled, an error occurred when power is applied while a Run signal is present. The inverter trips and does not go into Run Mode until the error is cleared.          | <input type="text" value="E 13"/> USP       | <input type="text" value="USP"/>           |
| Ground fault *5         | The inverter is protected by the detection of ground faults between the inverter output and the motor during powerup tests. This feature protects the inverter, and does not protect humans.                        | <input type="text" value="E 14"/> GND.Fit   | <input type="text" value="GND.Fit"/>       |
| Input over-voltage      | When the input voltage is higher than the specified value, it is detected 100 seconds after powerup and the inverter trips and turns OFF its output.  | <input type="text" value="E 15"/> OV.SRC    | <input type="text" value="OV.SRC"/>        |
| Inverter thermal trip   | When the inverter internal temperature is above the threshold, the thermal sensor in the inverter module detects the excessive temperature of the power devices and trips, turning the inverter output OFF.         | <input type="text" value="E 21"/> OH.FIN    | <input type="text" value="OH.FIN"/>        |
| Driver error            | An internal inverter error has occurred at the safety protection circuit between the CPU and main driver unit. Excessive electrical noise may be the cause. The inverter has turned OFF the IGBT module output.     | <input type="text" value="E 30"/> DRIV      | <input type="text" value="DRIV"/>          |
| Thermistor              | When a thermistor is connected to terminals [PTC] and [CM1] and the inverter has sensed the temperature is too high, the inverter trips and turns OFF the output.   | <input type="text" value="E 35"/> TH        | <input type="text" value="TH"/>            |
| Emergency Stop          | Emergency stop signal given.  | <input type="text" value="E 37"/> EMERGENCY | <input type="text" value="EMERGENCY"/>     |
| Communications error    | The inverter's watchdog timer for the communications network has timed out.   | <input type="text" value="E 60"/> COMM      | <input type="text" value="COMM"/>          |

Note 1: Reset operations acceptable 10 seconds after the trip.

Note 2: If an EEPROM error (E08) occurs, be sure to confirm the parameter data values are still correct.

Note 3: EEPROM error may occur at power-on after shutting down the power while copying data with remote operator or initializing data. Shut down the power after completing copy or initialization.

Note 4: USP error occurs at resetting trip after under-voltage error (E09) if USP is enabled. Reset once more to recover.

Note 5: Ground fault error (E14) cannot be released with resetting. Shut the power and check wiring.

## How to access the details about the present fault

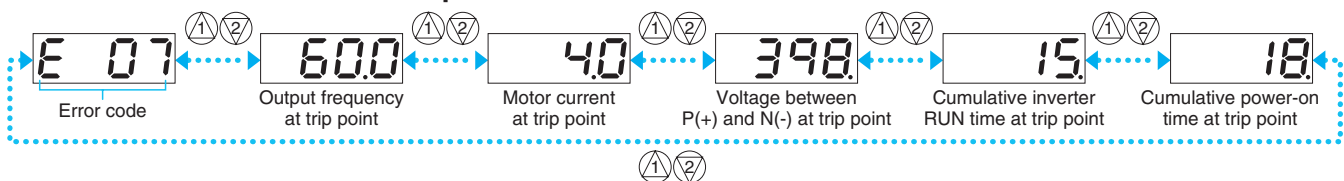

# Connecting Diagram

## Source type logic

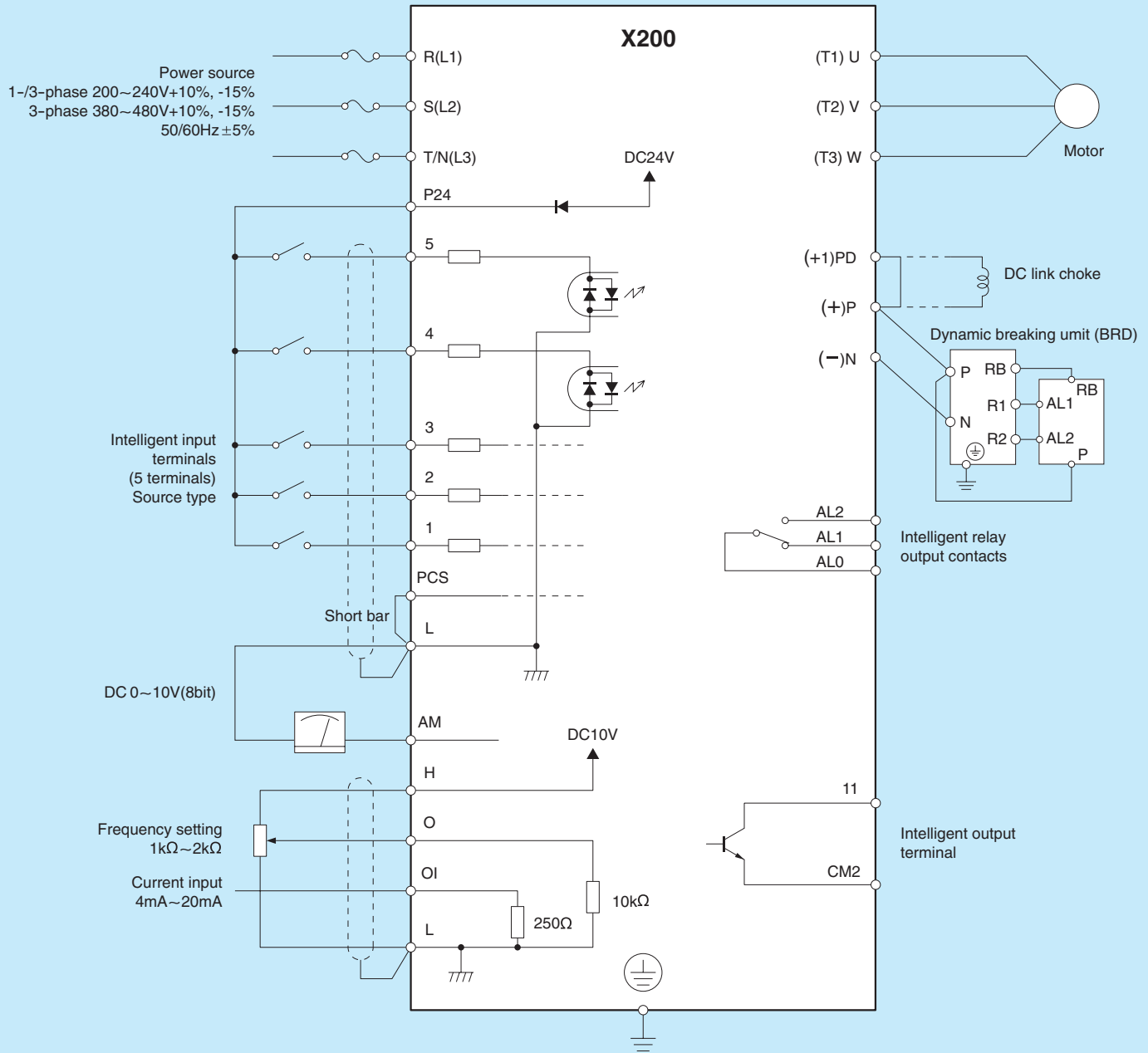

Note 1: Common terminals are depend on logic.

| Terminal | 1,2,3,4,5          | H,O,OI | 11  |
|----------|--------------------|--------|-----|
| Common   | Sink logic : L     | L      | CM2 |
|          | Source logic : PCS |        |     |

Note 2: Please choose proper inverter input volotage rating.

# Connecting Diagram

## Sink type logic

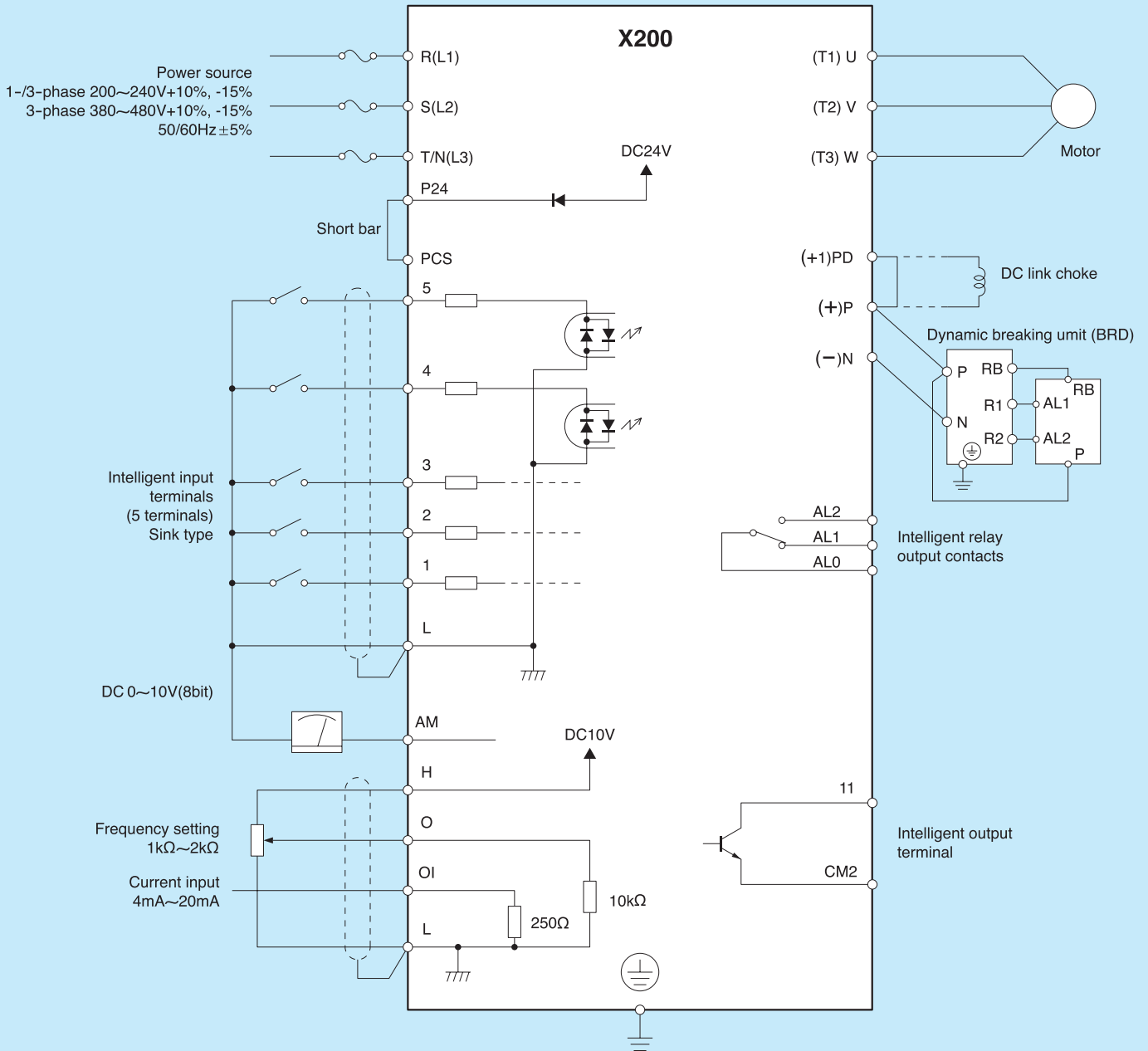

Note 1: Common terminals are depend on logic.

| Terminal | 1,2,3,4,5          | H,O,OI | 11  |
|----------|--------------------|--------|-----|
| Common   | Sink logic : L     | L      | CM2 |
|          | Source logic : PCS |        |     |

Note 2: Please choose proper inverter input volotage rating.

# Wiring and Accessories

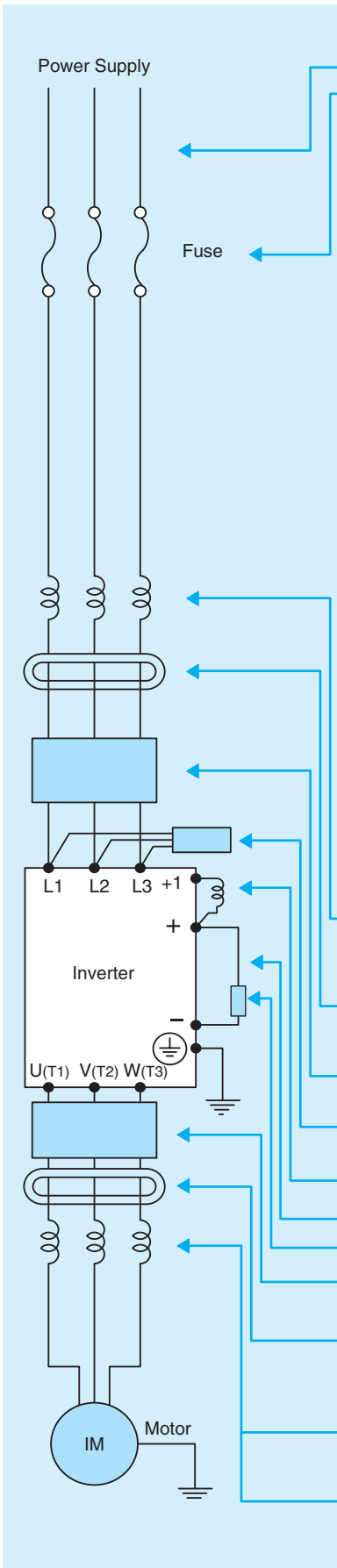

| Input Voltage | Applicable Motor (kW(HP)) | Model            | Wiring      |                 | Signal Lines  | Fuse (Class J)   |
|---------------|---------------------------|------------------|-------------|-----------------|---|------------------|
|               |                           |                  | Power Lines |                 |   |                  |
|               |                           |                  | AWG         | mm <sup>2</sup> |   |                  |
| 200V          | 0.2(1/4)                  | X200-002NFU/SFEF | 14          | 2.0             | 18 to 28 AWG<br>0.14 to 0.75mm <sup>2</sup><br>shelded wire | No fuse required |
|               | 0.4(1/2)                  | X200-004NFU/SFEF | 14          | 2.0             |   |                  |
|               | 0.55(3/4)                 | X200-005SFEF     | 14          | 2.0             |   |                  |
|               | 0.75(1)                   | X200-007NFU/SFEF | 14          | 2.0             |   |                  |
|               | 1.1(1.5)                  | X200-011SFEF     | 10          | 5.5             |   |                  |
|               | 1.5(2)                    | X200-015NFU/SFEF | 10          | 5.5             |   |                  |
|               | 2.2(3)                    | X200-022NFU/SFEF | 10          | 5.5             |   |                  |
|               | 3.7(5)                    | X200-037LFU      | 12          | 3.5             |   |                  |
|               | 5.5(7.5)                  | X200-055LFU      | 10          | 5.3             |   |                  |
| 7.5(10)       | X200-075LFU               | 8                | 8.4         |                 |   |                  |
| 400V          | 0.4(1/2)                  | X200-004HFU/HFEF | 16          | 1.25            | 18 to 28 AWG<br>0.14 to 0.75mm <sup>2</sup><br>shelded wire | 3                |
|               | 0.75(1)                   | X200-007HFU/HFEF | 16          | 1.25            |   | 6                |
|               | 1.5(2)                    | X200-015HFU/HFEF | 16          | 1.25            |   | 10               |
|               | 2.2(3)                    | X200-022HFU/HFEF | 14          | 2.0             |   | 10               |
|               | 3(4)                      | X200-030HFEF     | 14          | 2.0             |   | 15               |
|               | 4.0(5)                    | X200-040HFU/HFEF | 14          | 2.0             |   | 15               |
|               | 5.5(7.5)                  | X200-055HFU/HFEF | 12          | 3.3             |   | 20               |
|               | 7.5(10)                   | X200-075HFU/HFEF | 12          | 3.3             |   | 25               |

Note 1: Field wiring connection must be made by a UL and c-UL listed closed-loop terminal connector sized for the wire gauge involved. Connector must be fixed using the crimping tool specified by the connector manufacturer.

Note 2: Be sure to use large wire gauges for power wiring if the distance exceeds 20m (66ft).

Note 3: Use 0.75mm<sup>2</sup> /18 AWG wire for the relay terminals (AL0, AL1 and AL2) signal wire.

| Name                                  | Function   |
|---------------------------------------|--|
| Input side AC reactor                 | This is useful in suppressing harmonics induced on the power supplylines, or when the main power voltage imbalance exceeds 3% (and power source capacity is more than 500kVA), or to smooth out line fluctuations. It also improves the power factor.                            |
| Radio noise filter                    | Electrical noise interference may occur on nearby equipment such as a radio receiver. This magnetic choke filter helps reduce radiat-ed noise (can also be used on output).  |
| EMC filter                            | Reduces the conducted noise on the power supply wiring generated by the inverter. Connect to the inverter input side.  |
| Radio noise filter (Capacitor filter) | This capacitor filter reduces radiated noise from the main power wires in the inverter input side.   |
| DC link choke                         | Suppresses harmonics generated by the inverter.  |
| Braking resistor                      | This is useful for increasing the inverter's control torque for high duty-cycle (on-off) applications, and improving the decelerating capability.  |
| Braking unit                          |  |
| Output side noise filter              | Reduces radiated noise from wiring in the inverter output side.  |
| Radio noise filter                    | Electrical noise interference may occur on nearby equipment such as a radio receiver. This magnetic choke filter helps reduce radiated noise (can also be used on input).  |
| AC reactor                            | This reactor reduces the vibration in the motor caused by the inver-ter's switching waveforms, by smoothing the waveforms to approximate commercial power quality. It is also useful when wiring from the inverter to the motor is more than 10m in length, to reduce harmonics. |
| LCR filter                            | Sine wave shaping filter for the output side.  |

# Torque characteristics/Derating Curves

## Torque characteristics

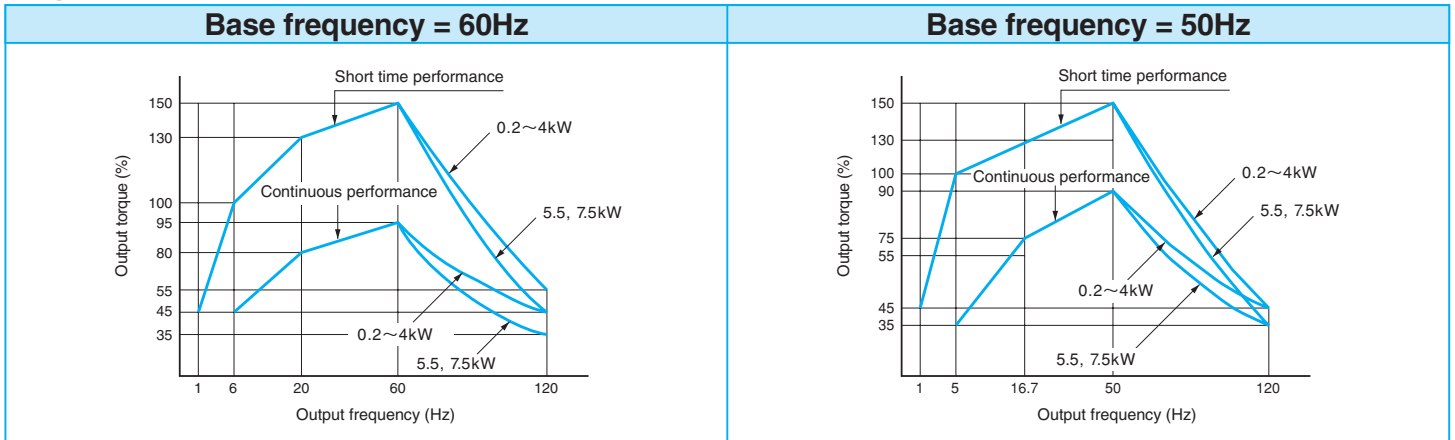

## Derating Curves

Use the following derating curves to help determine the optimal carrier frequency setting for your inverter and find the output current derating. Be sure to use the proper curve for your particular X200 inverter model number.

① Ambient temperature 40°C max., side-by-side mounting

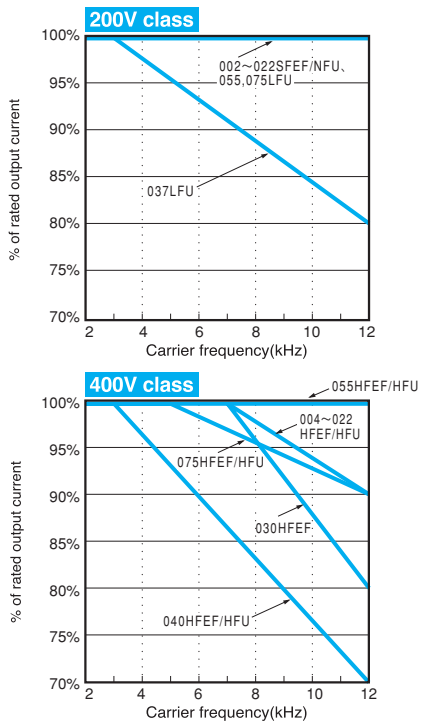

② Ambient temperature 50°C max., individual mounting

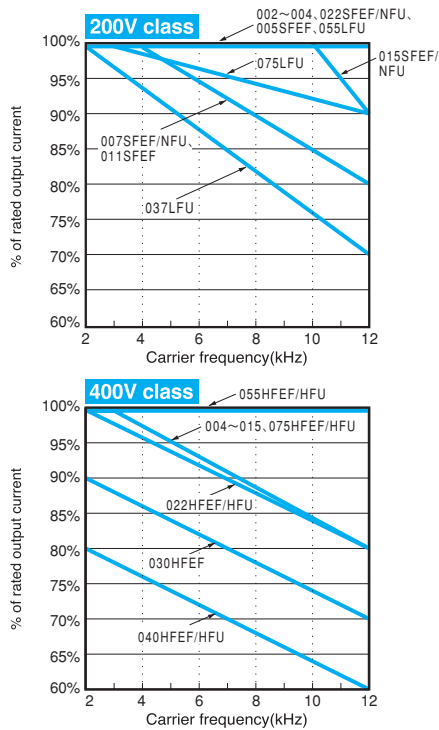

③ Ambient temperature 40°C max., individual mounting

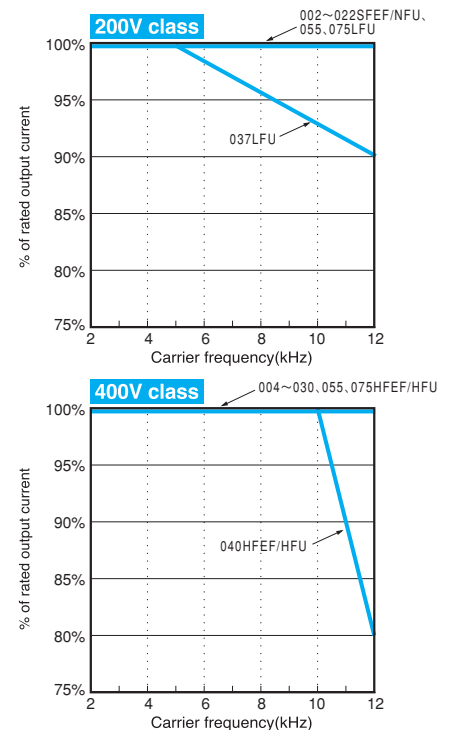

# For Correct Operation

## Application to Motors

### Application to general-purpose motors

|                                     |   |
|-------------------------------------|---|
| Operating frequency                 | The overspeed endurance of a general-purpose motor is 120% of the rated speed for 2 minutes (JIS C4,004). For operation at higher than 60Hz, it is required to examine the allowable torque of the motor, useful life of bearings, noise, vibration, etc. In this case, be sure to consult the motor manufacturer as the maximum allowable rpm differs depending on the motor capacity, etc.  |
| Torque characteristics              | The torque characteristics of driving a general-purpose motor with an inverter differ from those of driving it using commercial power (starting torque decreases in particular). Carefully check the load torque characteristic of a connected machine and the driving torque characteristic of the motor.  |
| Motor loss and temperature increase | The torque characteristics of driving a general-purpose motor with an inverter differ from those of driving it using commercial power   |
| Noise                               | When run by an inverter, a general-purpose motor generates noise slightly greater than with commercial power.   |
| Vibration                           | When run by an inverter at variable speeds, the motor may generate vibration, especially because of (a) unbalance of the rotor including a connected machine, or (b) resonance caused by the natural vibration frequency of a mechanical system. Particularly, be careful of (b) when operating at variable speeds a machine previously fitted with a constant speed motor. Vibration can be minimized by (1) avoiding resonance points using the frequency jump function of the inverter, (2) using a tire-shaped coupling, or (3) placing a rubber shock absorber beneath the motor base. |
| Power transmission mechanism        | Under continued, low-speed operation, oil lubrication can deteriorate in a power transmission mechanism with an oil-type gear box (gear motor) or reducer. Check with the motor manufacturer for the permissible range of continuous speed. To operate at more than 60Hz, confirm the machine's ability to withstand the centrifugal force generated.   |

### Application to special motors

|  |  |
|--|--|
| Gear motor                                       | The allowable rotation range of continuous drive varies depending on the lubrication method or motor manufacturer. (Particularly in case of oil lubrication, pay attention to the low frequency range.)  |
| Brake-equipped motor                             | For use of a brake-equipped motor, be sure to connect the braking power supply from the primary side of the inverter.  |
| Pole-change motor                                | There are different kinds of pole-change motors (constant output characteristic type, constant torque characteristic type, etc.), with different rated current values. In motor selection, check the maximum allowable current for each motor of a different pole count. At the time of pole changing, be sure to stop the motor. Also see: Application to the 400V-class motor. |
| Submersible motor                                | The rated current of a submersible motor is significantly larger than that of the general-purpose motor. In inverter selection, be sure to check the rated current of the motor.   |
| Explosion-proof motor                            | Inverter drive is not suitable for a safety-enhanced explosion-proof type motor. The inverter should be used in combination with a pressure-proof explosion-proof type of motor.<br>*Explosion-proof verification is not available for X200 Series.  |
| Synchronous (MS) motor<br>High-speed (HFM) motor | In most cases, the synchronous (MS) motor and the high-speed (HFM) motor are designed and manufactured to meet the specifications suitable for a connected machine. As to proper inverter selection, consult the manufacturer.   |
| Single-phase motor                               | A single-phase motor is not suitable for variable-speed operation by an inverter drive. Therefore, use a three-phase motor.  |

### Application to the 400V-class motor

A system applying a voltage-type PWM inverter with IGBT may have surge voltage at the motor terminals resulting from the cable constants including the cable length and the cable laying method. Depending on the surge current magnification, the motor coil insulation may be degraded. In particular, when a 400V-class motor is used, a longer cable is used, and critical loss can occur, take the following countermeasures:

- (1) install the LCR filter between the inverter and the motor,
- (2) install the AC reactor between the inverter and the motor, or
- (3) enhance the insulation of the motor coil.

## Notes on Use

### Drive

|                      |   |
|----------------------|---|
| Run/Stop             | Run or stop of the inverter must be done with the keys on the operator panel or through the control circuit terminal. Do not operate by installing an electromagnetic contactor (MC) in the main circuit.   |
| Emergency motor stop | When the protective function is operating or the power supply stops, the motor enters the free run stop state. When an emergency stop is required or when the motor should be kept stopped, use of a mechanical brake should be considered.   |
| High-frequency run   | A max. 400Hz can be selected on the X200 Series. However, a two-pole motor can attain up to approx. 24,000 rpm, which is extremely dangerous. Therefore, carefully make selection and settings by checking the mechanical strength of the motor and connected machines. Consult the motor manufacturer when it is necessary to drive a standard (general-purpose) motor above 60Hz. A full line of high-speed motors is available from Hitachi. |

### Installation location and operating environment

Avoid installation in areas of high temperature, excessive humidity, or where moisture can easily collect, as well as areas that are dusty, subject to corrosive gasses, mist of liquid for grinding, or salt. Install the inverter away from direct sunlight in a well-ventilated room that is free of vibration. The inverter can be operated in the ambient temperature range from -10 to 50°C. (Carrier frequency and output current must be reduced in the range of 40 to 50°C.)



# For Correct Operation

## Main power supply

|  |  |
|--|--|
| <p>Installation of an AC reactor on the input side</p> | <p>In the following examples involving a general-purpose inverter, a large peak current flows on the main power supply side, and is able to destroy the converter module. Where such situations are foreseen or the connected equipment must be highly reliable, install an AC reactor between the power supply and the inverter. Also, where influence of indirect lightning strike is possible, install a lightning conductor.</p> <p>(A) The unbalance factor of the power supply is 3% or higher. (Note)<br/>         (B) The power supply capacity is at least 10 times greater than the inverter capacity (the power supply capacity is 500 kVA or more).<br/>         (C) Abrupt power supply changes are expected.</p> <p>Examples:<br/>         (1) Several inverters are interconnected with a short bus.<br/>         (2) A thyristor converter and an inverter are interconnected with a short bus.<br/>         (3) An installed phase advance capacitor opens and closes.</p> <p>In cases (A), (B) and (C), it is recommended to install an AC reactor on the main power supply side.<br/>         Note: Example calculation with <math>V_{RS} = 205V</math>, <math>V_{ST} = 201V</math>, <math>V_{TR} = 200V</math><br/> <math>V_{RS}</math> : R-S line voltage, <math>V_{ST}</math> : S-T line voltage, <math>V_{TR}</math> : T-R line voltage</p> |
| <p>Using a private power generator</p>                 | <p>An inverter run by a private power generator may overheat the generator or suffer from a deformed output voltage waveform of the generator. Generally, the generator capacity should be five times that of the inverter (kVA) in a PWM control system, or six times greater in a PAM control system.</p>  |

## Notes on Peripheral Equipment Selection

|  |   |
|--|---|
| <p>Wiring connections</p>                | <p>(1) Be sure to connect main power wires with R(L1), S(L2), and T(L3) terminals (input) and motor wires to U(T1), V(T2), and W(T3) terminals (output). (Incorrect connection will cause an immediate failure.)<br/>         (2) Be sure to provide a grounding connection with the ground terminal (⊕).</p>   |
| <p>Wiring between inverter and motor</p> | <p>Electromagnetic contactor<br/>         When an electromagnetic contactor is installed between the inverter and the motor, do not perform on-off switching during running operation.</p>  |
|  | <p>Thermal relay<br/>         When used with standard applicable output motors (standard three-phase squirrel-cage four-pole motors), the X200 Series does not need a thermal relay for motor protection due to the internal electronic protective circuit. A thermal relay, however, should be used:<br/>         • during continuous running outside a range of 30 to 60 Hz.<br/>         • for motors exceeding the range of electronic thermal adjustment (rated current).<br/>         • when several motors are driven by the same inverter; install a thermal relay for each motor.<br/>         • The RC value of the thermal relay should be more than 1.1 times the rated current of the motor. Where the wiring length is 10 m or more, the thermal relay tends to turn off readily. In this case, provide an AC reactor on the output side or use a current sensor.</p> |
| <p>Installing a circuit breaker</p>      | <p>Install a circuit breaker on the main power input side to protect inverter wiring and ensure personal safety. Choose an inverter-compatible circuit breaker. The conventional type may malfunction due to harmonics from the inverter. For more information, consult the circuit breaker manufacturer.</p>   |
| <p>Wiring distance</p>                   | <p>The wiring distance between the inverter and the remote operator panel should be 20 meters or less. When this distance is exceeded, use CVD-E (current-voltage converter) or RCD-E (remote control device). Shielded cable should be used on the wiring. Beware of voltage drops on main circuit wires. (A large voltage drop reduces torque.)</p>   |
| <p>Earth leakage relay</p>               | <p>If the earth leakage relay (or earth leakage breaker) is used, it should have a sensitivity level of 15 mA or more (per inverter).</p>   |
| <p>Phase advance capacitor</p>           | <p>Do not use a capacitor for power factor improvement between the inverter and the motor because the high-frequency components of the inverter output may overheat or damage the capacitor.</p>  |

## High-frequency Noise and Leakage Current

- (1) High-frequency components are included in the input/output of the inverter main circuit, and they may cause interference in a transmitter, radio, or sensor if used near the inverter. The interference can be minimized by attaching noise filters (option) in the inverter circuitry.
- (2) The switching action of an inverter causes an increase in leakage current. Be sure to ground the inverter and the motor.

## Lifetime of Primary Parts

Because a DC bus capacitor deteriorates as it undergoes internal chemical reaction, it should normally be replaced every five years. Be aware, however, that its life expectancy is considerably shorter when the inverter is subjected to such adverse factors as high temperatures or heavy loads exceeding the rated current of the inverter. The approximate lifetime of the capacitor is as shown in the figure at the right when it is used 12 hours daily (according to the "Instructions for Periodic Inspection of General-Purpose Inverter" (JEMA).) Also, such moving parts as a cooling fan should be replaced. Maintenance inspection and parts replacement must be performed by only specified trained personnel.

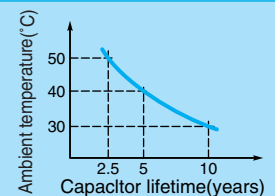

## Precaution for Correct Usage

- Before use, be sure to read through the Instruction Manual to insure proper use of the inverter.
- Note that the inverter requires electrical wiring; a trained specialist should carry out the wiring.
- The inverter in this catalog is designed for general industrial applications. For special applications in fields such as aircraft, outer space, nuclear power, electrical power, transport vehicles, clinics, and underwater equipment, please consult with us in advance.
- For application in a facility where human life is involved or serious losses may occur, make sure to provide safety devices to avoid a serious accident.
- The inverter is intended for use with a three-phase AC motor. For use with a load other than this, please consult with us.



# MEMO

A series of horizontal dashed lines for writing.

