

Series 41 and 81 Modutrol IV™ Motors

PRODUCT DATA



FEATURES

- Replaces M445, M845 and M865 motors.
- Models rated for 60 lb.-in. torque.
- Fixed torque throughout the entire voltage range.
- Integral spring return returns motor to normal position when power is interrupted.
- Integral junction box provides NEMA 3 weather protection.
- Motor and circuitry operate from 24 Vac. Models available with factory installed transformer, or a field added internal transformer.
- Quick-connect terminals are standard—screw terminal adapter is available.
- Adapter bracket for matching shaft height of older motors is available.
- Motors have field adjustable stroke (90° to 160°).
- Die-cast aluminum housing.
- Motors are designed for either normally open or normally closed valves and dampers.
- All models have auxiliary switch cams.
- Integral auxiliary switches are available factory mounted, or can be field added.
- Motors can operate valve linkages from the power end or auxiliary end shafts for normally closed or normally open valve applications.
- All models have dual shafts (slotted and tapped on both ends).
- Nominal timing standard of 30 seconds (90° stroke), and 60 seconds (160° stroke). Other timings available.

APPLICATION

The Series 41 and Series 81 Modutrol IV Motors are 2-position (line- and low- voltage control, respectively) spring-return motors. They are used to operate dampers or valves in applications where it is necessary or desirable to have the controlled element return to the starting position in the event of power failure or interruption.

Contents

Application	1
Features	1
Specifications	2
Ordering Information	2
Installation	4
Operation and Checkout	10
Replacement	10



SPECIFICATIONS

Models: TRADELINE models are selected and packaged to provide ease of stocking, ease of handling and maximum replacement value. TRADELINE model specifications are the same as those of standard models unless specified otherwise.

Dimensions: See Fig. 2.

Crankshaft: 3/8 in. (9.5 mm) square.

Electrical Ratings: See Table 2.

Modutrol IV Order Number Guide: See Table 1.

Table 1. Series 41 and Series 81 Modutrol IV Model Number Guide.

M	Motor					
	41	Series 41, line voltage, two-position control				
	81	Series 81, low voltage, two-position control				
	8	60 lb-in. torque				
	5	Normally Closed Spring Return, dual-ended shaft				
	A	0 Auxiliary Switches	Adjustable Stroke	Normally Closed		
	B	1 Auxiliary Switch				
C	2 Auxiliary Switches					
D	0 Auxiliary Switch					

M	81	8	5	A	XXXX	See Catalog for Complete O.S. Number
----------	-----------	----------	----------	----------	-------------	--------------------------------------

Table 2. Power Consumption Ratings.

Model Number	VA Rating
M4185	20

Controller Type: Two wire, on-off switching action.

Dead Weight Load On Shaft (maximum):
 Power or Auxiliary End: 200 lb. [90.8 kg].
 Combined Load: 300 lb. [136 kg]. (Dual-stroke motors only.)

Auxiliary Switch Ratings: See Table .

Maximum Damper Rating [B Dimension]:
 60 lb.-in. Models: 34 in.

NOTE: The B dimension is the length of the damper side perpendicular to the drive shaft.

Ambient Temperature Ratings:
 Maximum: 150°F (66°C).
 Minimum: -40°F (-40°C).

Stroke:
 90° Stroke: 30 seconds.
 160° Stroke: 60 seconds.

Torque: 60 lb-in. (6.8 N•m).

Table 3. Primary 50017460-001 Color Code

Lead Color	Primary Voltage
Brown	24 VAC
White	120 VAC
Blue	230 VAC
Black	Common

Table 4. Auxiliary Switch Ratings.

One Contact Rating ^a (Amps)	120 V	240 V
Full Load	7.2	3.6
Locked Rotor	43.2	21.6

^a 40 VA pilot duty, 120/240 Vac on opposite contact.

Approvals:
 Underwriters Laboratories Inc. Listed: File No. E4436, Guide No. XAPX for USA and Canada.
 U.S. Patents: pending.

ORDERING INFORMATION

When purchasing replacement and modernization products from your TRADELINE® wholesaler or distributor, refer to the TRADELINE® Catalog or price sheets for complete ordering number.

If you have additional questions, need further information, or would like to comment on our products or services, please write or phone:

1. Your local Honeywell Automation and Control Products Sales Office (check white pages of your phone directory).
2. Honeywell Customer Care
 1885 Douglas Drive North
 Minneapolis, Minnesota 55422-4386

International Sales and Service Offices in all principal cities of the world. Manufacturing in Australia, Canada, Finland, France, Germany, Japan, Mexico, Netherlands, Spain, Taiwan, United Kingdom, U.S.A.

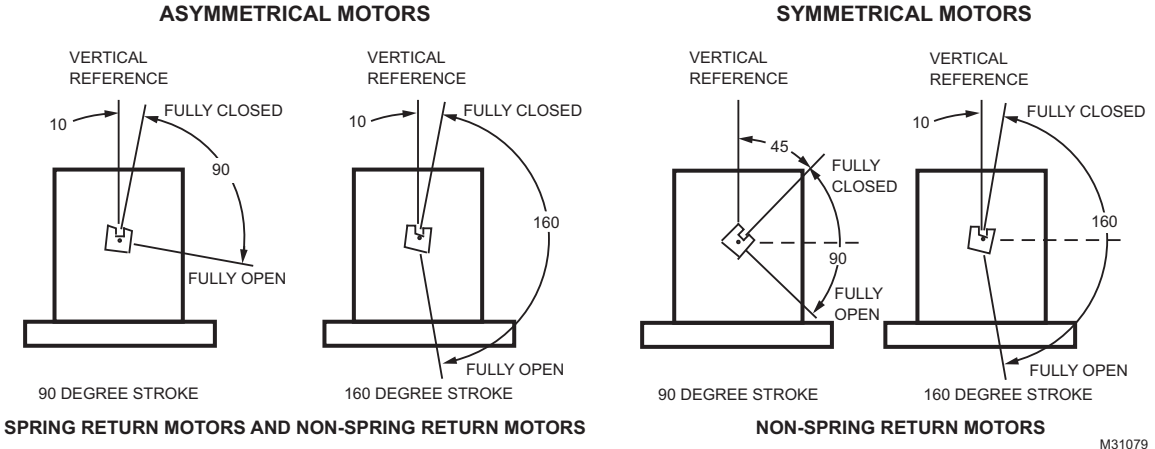

M31079

Fig. 1. Stroke

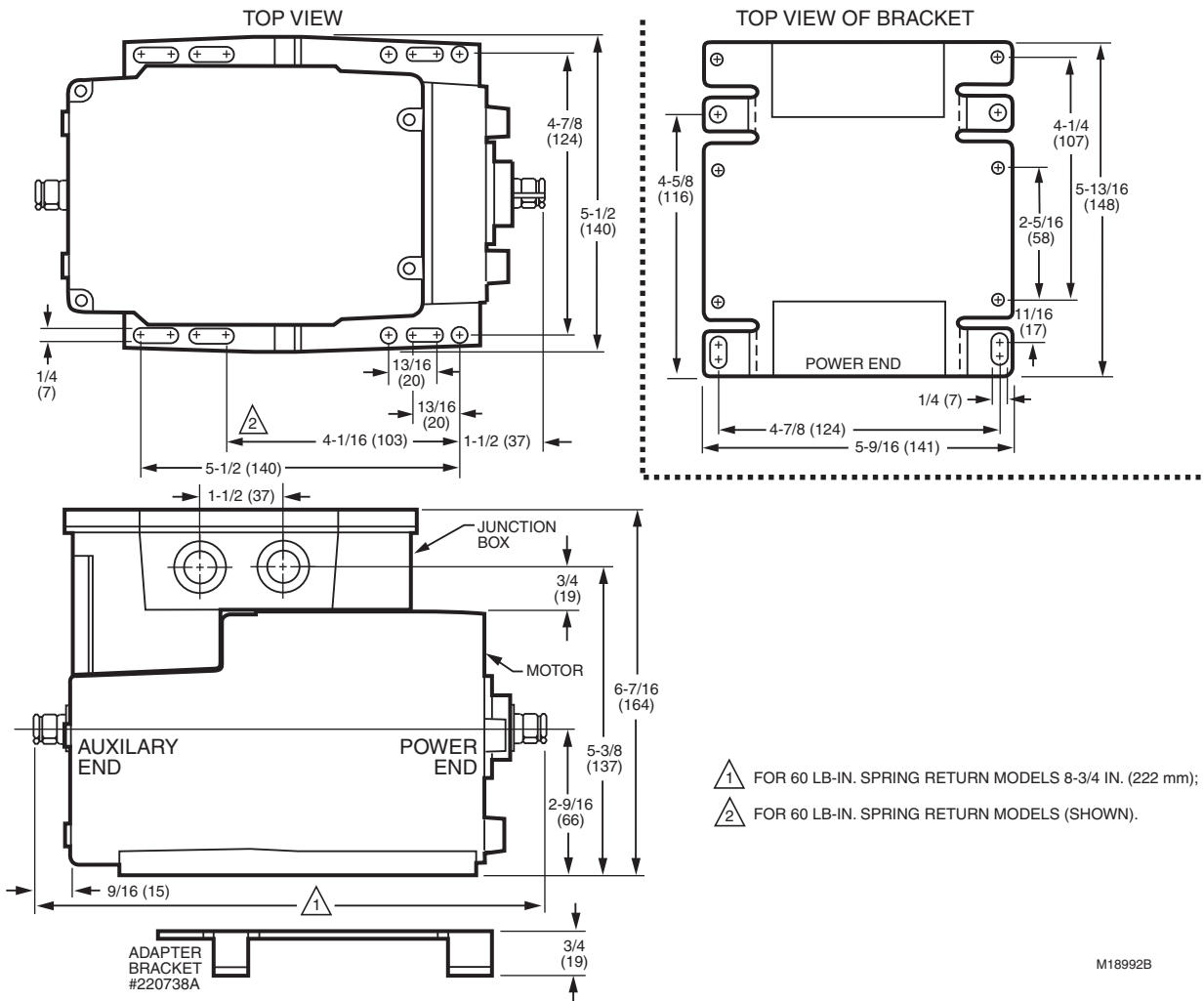

M18992B

Fig. 2. Series 41 and Series 81 Modutrol IV Motor mounting dimensions in inches (mm).

Accessories:

- 220736 Internal Auxiliary Switch Kit can be field-installed. One-(220736A) and Two- (220736B) switch kits available.
- 220738A Adapter Bracket raises motor shaft height by 3/4 in. (19 mm) to match that of previous Modutrol Motor models.
- 220741A Screw Terminal Adapter converts the standard quick-connect terminals to screw terminals.
- 221455A Infinitely Adjustable Crank Arm approximately 3/4 in. shorter than the 4074ELY Crank Arm, can rotate through downward position and clear motor base without requiring adapter bracket.
- 4074ERU Weatherproofing Kit provides NEMA 3 rating for Modutrol IV Motors mounted in position other than upright.
- 50017460-001 Internal Transformer; 24/120/230 Vac 50/60 Hz primary, 24 Vac secondary, quick connect terminals.
- 50017460-003 Internal Transformer; 120 Vac 50/60 Hz primary, 24 Vac secondary, quick connect terminals.
- 7617ADW Crank Arm approximately 3/4 in. shorter than 7616BR Crank Arm. Can rotate through downward position and clear motor base without requiring adapter bracket.
- Q100 Linkage connects Modutrol Motor to V51 Butterfly Valve. Requires the 220738A Adapter Bracket.
- Q5001 Bracket and Linkage Assembly connects Modutrol motor to a water or steam globe valve.
- Q605 Damper Linkage connects motor to damper. Includes motor crank arm.
- Q607 External Auxiliary Switch controls auxiliary equipment as a function of motor position.
- ES650-117 Explosion-Proof Housing encloses motor for use in explosive atmospheres. Also required, a 7617DM coupling assembly from Honeywell to use with the cover. Not for use with Q5001 (or any other valve linkages). To order ES650-117 contact EGS Enclosures at (281) 449-6271, ask for the sales department and for distribution in your area.

INSTALLATION

When Installing this Product...

1. Read these instructions carefully. Failure to follow them could damage the product or cause a hazardous condition.
2. Check the ratings given in the instructions and on the product to make sure the product is suitable for your application.

3. Installer must be a trained, experienced service technician.
4. After installation is complete, check out product operation as provided in these instructions.



CAUTION

Electrical Shock or Equipment Damage Hazard.
Can shock individuals or short equipment circuitry.

Disconnect all power supplies before installation. Motors with auxiliary switches can have more than one disconnect.



CAUTION

Equipment Damage Hazard.
Can damage the motor beyond repair.

Never turn the motor shaft by hand or with a wrench. Forcibly turning the motor shaft damages the gear train and stroke limit contacts.

Location

Allow enough clearance for installing accessories and motor servicing when selecting a location (see Fig. 2). If located outdoors, use liquid-tight conduit connectors with the junction box to provide NEMA 3 weather protection. If mounted outdoors in a position other than upright, install a 4074ERU Weatherproofing Kit and liquid-tight connectors to provide NEMA 3 protection.



CAUTION

Motor Damage Hazard.
Deteriorating vapors and acid fumes can damage metal parts.

Install motor in areas free of acid fumes and other deteriorating vapors.

In excessive salt environments, mounting base and screws should be zinc or cadmium plated, not stainless steel or brass. Use the 220738A Adapter Bracket for mounting on these surfaces.

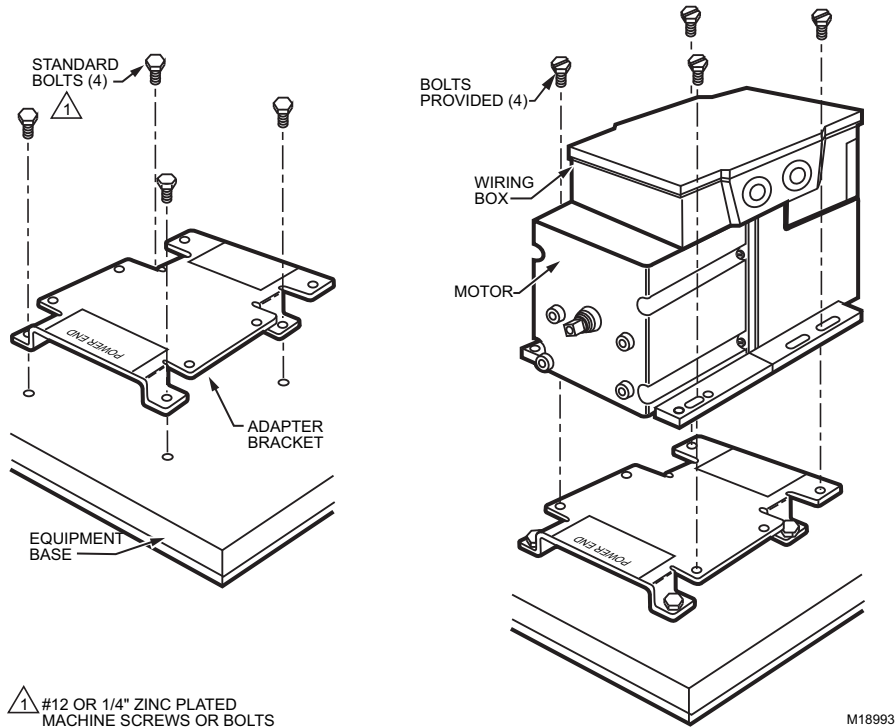

Fig. 3. Mounting the motor with an adapter bracket.

Mounting

Use the following guidelines for proper motor mounting:

- Always install motors with the crankshaft horizontal.
- Mounting flanges extending from motor housing base are drilled for 6.4 mm machine screws or bolts.
- Motors are shipped from the factory in their normal position:
 - Normally closed models are shipped at the counter-clockwise rotation limit (viewed from the power end).

NOTE: Refer to Fig. 1 for graphical representation of fully-open and fully-closed positions.

Adapter Bracket

The 220738A Adapter Bracket, positioned between the motor and the equipment, raises motor shaft height by 19 mm to match that of previous Modutrol Motor models.

The following applications require this bracket:

- Q607 External Auxiliary Switch.
- Damper linkage applications require added clearance to allow:
 - Crank arm rotation through the downward position.
 - Sufficient damper linkage to reach the motor shaft.
- All valve linkages except the Q5001.

NOTE: When the bracket is not used in a replacement application, the damper linkage can require adjustment for the new shaft position.

To mount the motor with the bracket:

1. Mount the bracket to the equipment with existing or standard bolts.
2. Using the provided bolts, mount the motor to the bracket threaded holes. See Fig. 3.

For valve linkage applications (other than the Q5001):

1. Mount the bracket to the linkage.
2. Position the motor on the bracket to align the motor shaft with the linkage.
3. Attach the motor to the bracket with the four bolts (provided).

NOTE: The bolts go through the motor flange holes and into the threaded holes of the bracket.

Damper Linkages

Use of the 220738A Adapter Bracket is optional for many damper applications. This bracket or a 221455A Crank Arm might be needed in applications that require the crank arm to rotate through the motor bottom plane.

NOTE: Replacement applications where the shaft height changes require damper linkage adjustment.

The motor is supplied without a crank arm. The crank arm is included in the Q605 Linkage or can be ordered separately (see Accessories in the Specifications section).

For detailed instructions on specific linkage assembly, refer to the instruction sheet packed with the linkage. In general, however, check the following points of operation when installing a motor and linkage:

- The motor must be permitted to complete its full stroke. Damper or valve induced motor stall can damage the motor. Adjust valve and louver-type damper linkages so that the damper or valve moves through no more than the maximum required distance when the motor moves through its full stroke.
- Maximum damper opening should be no more than 60°. Little additional airflow is provided beyond this point.
- Do not exceed the motor ratings in any installation.

— Do not turn the motor shaft manually or with a wrench.
This damages the motor.

Valve Linkages

Use the 220738A Adapter Bracket with the Q100 Linkage in all valve applications. The 220738A Adapter Bracket is not required with the Q5001 Valve Linkage (see Fig. 4).

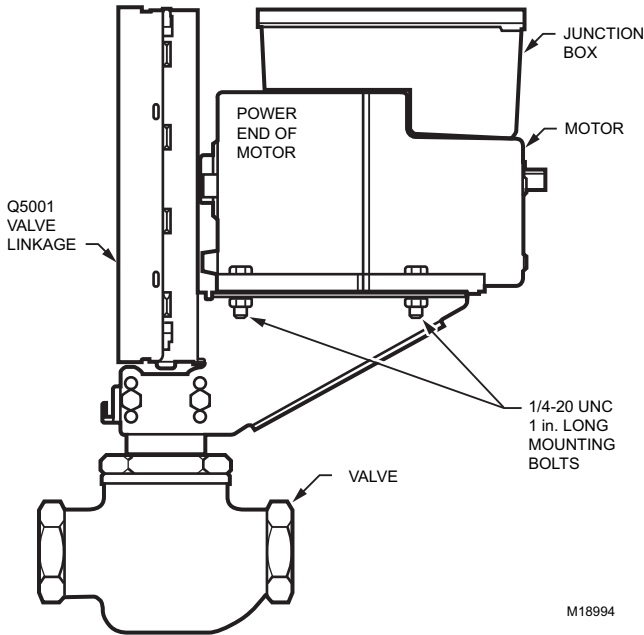

M18994

Fig. 4. Mounting the motor on a Q5001 valve linkage.

Wiring

⚠ CAUTION

Electrical Shock or Equipment Damage Hazard.
Can shock individuals or short equipment circuitry.

Disconnect all power supplies before installation.
Motors with auxiliary switches can have more than one disconnect.

IMPORTANT

All wiring must comply with applicable codes, ordinances and regulations.

Make sure that the voltage and frequency stamped on the motor correspond to the power supply characteristics.

Fig. 5 shows the motor terminals (quick-connects located on top of the printed circuit board). Wiring compartment access is gained by removing the four screws from the junction box top and lifting off the cover.

See Fig. 6 through 10 for typical system wiring. Fig. 12 shows auxiliary switch connections.

Junction Box

When used with liquid-tight conduit connectors, the junction box provides NEMA 3 weather protection for the motor. The box also provides knockouts for wiring conduits and encloses terminals. The junction box is required for housing an internal transformer or internal auxiliary switches.

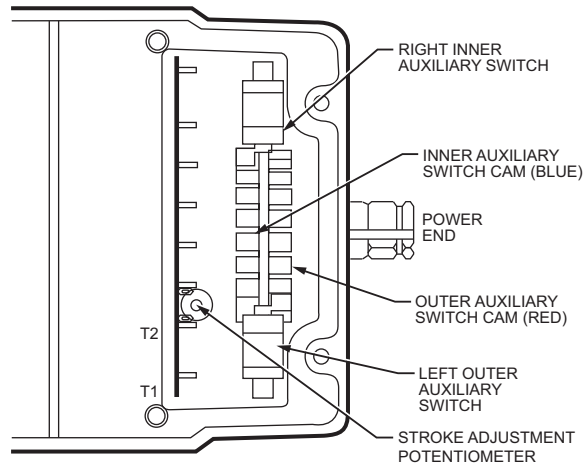

NOTE: FEATURES AVAILABLE ON SOME MODELS ONLY.

M18995A

Fig. 5. Terminals and adjustments.

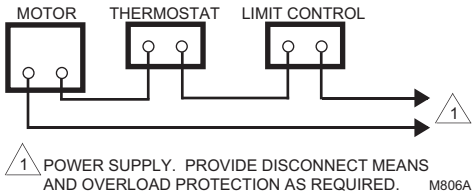

Fig. 6. Typical connections for Series 41 Motors.

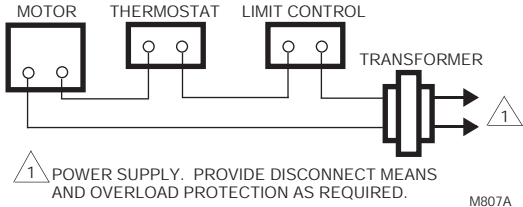

Fig. 7. Typical connections for Series 81 Motors.

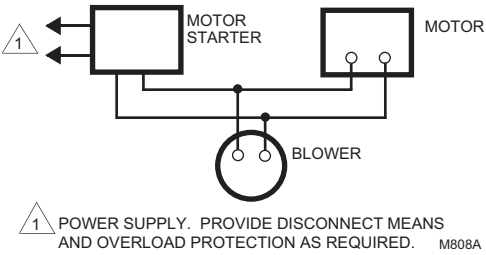

Fig. 8. Power connections for Series 41 Line Voltage Motors controlling two-position outside air dampers.

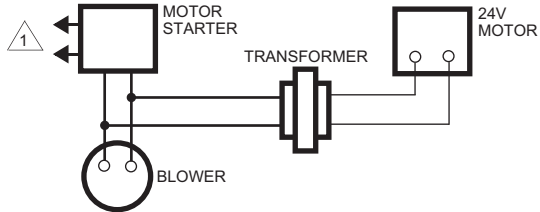

Fig. 9. Power connections for Low Voltage Motors controlling two-position outside air dampers.

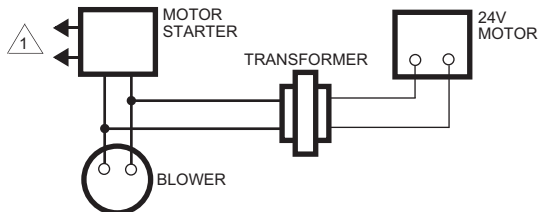

Fig. 10. Wiring connections for Series 81 Motors controlling two-position pre-heat coil valves.

SETTINGS AND ADJUSTMENTS



Before Setting Stroke

1. Remove the top cover from the motor.
2. Disconnect the controller from the motor.
3. For models with an internal transformer (line voltage motors), ensure that power (and nothing else) remains connected to the motor.

IMPORTANT

Detach linkage from motor before adjusting stroke.

Adjustable Stroke

When viewing from the power end of the motor, the stroke potentiometer is to the far left. To set the stroke to 160° (maximum position) turn the potentiometer fully clockwise , using a 1/8 in. straight-blade screwdriver. To set the stroke at 90° (minimum position) turn the potentiometer fully counter-clockwise . Setting the potentiometer anywhere between fully clockwise and fully counter-clockwise will set the stroke between 160° and 90°.

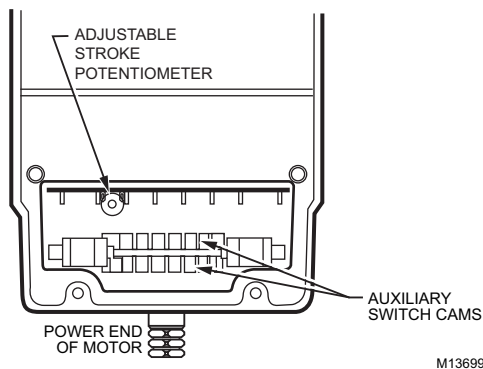

Fig. 11. Stroke adjustments.



CAUTION

Careless Installation Hazard.

Use of excessive force while adjusting cams damages the motor.

To avoid damaging motor end switches, set cams by moving only the screwdriver top.



CAUTION

Equipment Damage Hazard.

Can damage the motor beyond repair.

Never turn the motor shaft by hand or with a wrench. Forcibly turning the motor shaft damages the gear train and stroke limit contacts.

Auxiliary Switches

The auxiliary switches are spdt switches that are actuated by adjustable cams. The cams are factory-mounted on the motor shaft at the power end of the motor. The cam settings determine the point in motor shaft rotation at which the auxiliary equipment will be switched on or off. These cams can be set to actuate the switches at any angle within the motor stroke.

NOTE: Series 2 Motors are shipped with auxiliary switch cams that permit acceptance of 220736A,B Internal Auxiliary Switch Kits. Refer to Form no. 63-2228 for 220736A,B Installation Instructions.

For auxiliary switch wiring, see Fig. 12.

With a 1° differential, the N.C. switch contacts make and the N.O. switch contacts break on a counterclockwise (closed) rotation. If a 10° differential is chosen, the operation is reversed, the N.O. switch contacts make and the N.C. switch contacts open on a counterclockwise (closed) rotation.

NOTE: When the slow-rise portion of the cam is used, the switching differential is approximately 10° of rotation. When the fast-rise portion of the cam is used, the switching differential is approximately 1° of rotation. Do not use the fast rise portion of the cam if fast cycling of auxiliary equipment is undesirable.

Switching action is different depending on whether 1° or 10° differential is chosen. See Table .

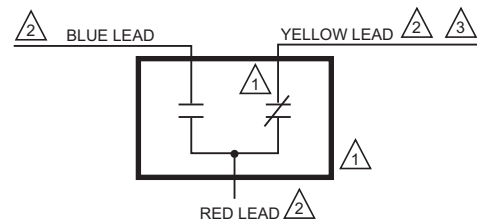

- ① USE NEC CLASS 1 WIRING UNLESS POWER SUPPLY MEETS CLASS 2 REQUIREMENTS. TAPE UNUSED LEADS. ENSURE THE CURRENT DRAW OF THE EXTERNAL CIRCUIT IS LESS THAN SWITCH CONTACT RATING.
- ② ON TWO-SWITCH MOTORS, SECOND SWITCH HAS BLACK LEADS WITH BLUE, YELLOW, AND RED TRACERS.
- ③ SOME AUXILIARY SWITCH ASSEMBLIES INCLUDE ONLY RED AND YELLOW LEADS. SOME OTHERS DO NOT INCLUDE THE YELLOW LEAD.

M17099

Fig. 12. Auxiliary switch schematic.



WARNING

Fire or Explosion Hazard.

Incorrect auxiliary switch wiring can allow the burner to come on at high fire causing severe injury or death.

Check auxiliary switch wiring and cam adjustment before turning on the system.

Watch controlled equipment through a complete cycle. Shut the system down immediately if switches do not sequence the equipment correctly.

Auxiliary Switch Adjustment

Adjustable cams actuate the auxiliary switches. These cams can be set to actuate the switches at any angle within the stroke of the motor. Select switch differential of 1° or 10°.

NOTES:

- Auxiliary switches can only be added to motors that include auxiliary switch cams. (These cams cannot be field-added.)
- Normally Closed motors are shipped in the closed position (counterclockwise, viewed from the power end) with auxiliary switch cams set to operate switches 30° from closed position with a 1° differential. With motor in fully closed position, the N.C. auxiliary switch contacts are closed.
- See Fig. 12 (or the auxiliary switch Instruction Sheet) for auxiliary switch wiring.
- Motors are shipped with auxiliary switch cams.

To rotate a cam, insert a small screwdriver (1/8 in. or 3 mm blade) through the junction box into the slot on the cam and move the screwdriver at the top of the handle. The inner cam

actuates the right switch and the outer cam actuates the left switch (viewed from the power end). Refer to Fig. 11. Each division on the cam represents 15° of motor rotation.

1. Turn off the power and remove the junction box cover.
2. Determine the amount of shaft rotation, in degrees, desired before the switch is to be energized.
3. Note the cam slot positions.
4. With a screwdriver, rotate the cam to the desired angle for switching action. As noted above, each cam division represents 15° of motor rotation. Therefore, if 60° of motor rotation is desired before the switch operates, rotate the cam four divisions from the reference point.
5. Turn on the power.
6. Check for proper switch differential and switching of auxiliary equipment by driving the motor through full stroke (in both directions). If necessary, repeat steps 3 and 4 until correct switching action is obtained, turning off the power before readjusting the cam.
7. When adjustments are complete, replace the junction box cover.

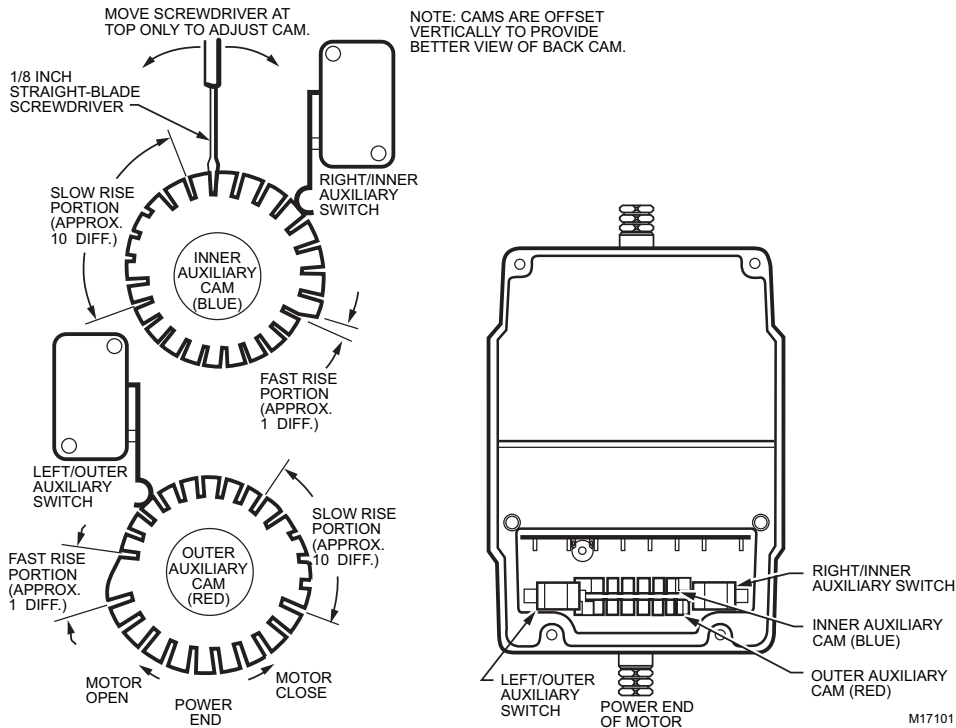

Fig. 13. Auxiliary switch adjustments.

Table 5. Auxiliary Switch Position with Motor Shaft Rotated to Either Side of Auxiliary Switch Operating Point

Switch Differential	Auxiliary Switch Contact Positions (Viewed from the Power End)			
	N.O. Contact		N.C. Contact	
	Shaft Rotated ccw of Switch Point	Shaft Rotated cw of Switch Point	Shaft Rotated ccw of Switch Point	Shaft Rotated cw of Switch Point
1°	Open	Closed	Closed	Open
10°	Closed	Open	Open	Closed

OPERATION AND CHECKOUT

Operation

In an operational circuit, a single-pole, single-throw controller or fan starter (line voltage for Series 41, or low voltage for Series 81) is wired in series with the motor circuit. When the controller switch closes, the motor is energized and runs to the end of its stroke. When the motor reaches its full stroke, it holds this position as long as it is energized. When the controller opens, the spring returns to the starting position.

Checkout

After the installation is complete, check the entire system for the following points of operation:

- Motor operates the load properly.
- Motor responds properly to the controller.
- Motor returns to starting position when power is interrupted.

Damper Application

1. Check the entire motor-damper linkage to ensure that the mechanical connections are secure and properly made. Be certain the ball joint on the damper crank arm is properly placed to give the required amount of travel.
2. Energize the motor and run it to the end of its stroke. Check the damper linkage while the motor is running to see that there are no loose or binding connections.
3. If the motor does not run, check the control circuit for an open or short, the presence of power, and voltage at the motor. Voltage at the motor must be at least 85 percent of the rated voltage (specified on nameplate.) Ensure that the maximum motor net load is not exceeded.
4. Interrupt the power to de-energize the motor and allow the spring to return the motor to the starting position. If the motor does not return, check to ensure that power is actually interrupted and that the return load is not exceeding the rated motor load.

Valve Application

1. Check entire motorized valve assembly to ensure that the mechanical connections (among motor, linkage, and valve) are proper and secure. Be certain that the linkage is adjusted according to the linkage instructions. Leave the linkage cover off until the checkout is completed.
2. Be certain the load does not exceed the motor rating. When using a Q5001 Linkage, no lubrication is required. Install the plastic washer on the motor shaft between the motor and cam to avoid motor binding and stalling. Check to ensure that the linkage spring compression is within the limits specified in the Q5001 Installation Instructions.
3. Energize the motor by setting the controller so that its contacts close.

NOTES: The motor should start and run smoothly, moving the valve stem to the opposite end of its stroke. If this is not the case:

- Ensure there is power to the motor.
- If there is not power, check the controller circuit for open or short circuits.
- If the trouble still cannot be found, measure the voltage at the source.
- Line voltage must be at least 85 percent of rated voltage stamped on motor nameplate.

4. De-energize motor by resetting the controller so its contacts open, or remove one wire from a controller terminal. Spring power should return the valve to normal position. If this does not happen, check the linkage for binding, or in the case of normally closed valves, check for fluid pressure in excess of the close-off rating.
5. Replace the linkage cover.

REPLACEMENT

Damper Application

1. Turn off power and remove wiring from the old motor.
2. Remove crank arm from the old motor shaft and remove the old motor.
3. Check to determine whether or not the mounting bracket is needed. If the linkage can reach the new motor lower shaft position and the crank arm has clearance for the necessary rotation, then the bracket is not required. Use the 220738A Adapter Bracket or the 221455A Crank Arm if the crank arm must rotate through the motor bottom plane.
4. If no bracket is required, mount the new motor directly to the equipment and refer as necessary to Installation, Settings and Adjustments, and Operation and Checkout sections of these instructions.
5. If the bracket is required, refer to the Adapter Bracket section and see Fig. 3 in addition to the Installation, Settings and Adjustments, and the Operation and Checkout sections of these instructions.
6. Use old mounting bolts to mount the new motor.
7. Mount the damper crank arm and linkage to the shaft of the new motor.
8. Use the Checkout procedures to test proper adjustment of the crank arm and linkage.

Valve Application

When replacing a motor in a valve application that has a Q100, Q601 or Q618 Linkage, it will be necessary to use the 220738A Adapter Bracket provided to raise the motor shaft to the same height as that of the old motor. In valve applications that have a Q5001 Linkage, the 220738A Adapter Bracket is unnecessary. Ensure motor stroke is 160° to operate Honeywell V5011 Two-way or V5013 Three-way Valves.

By using this Honeywell literature, you agree that Honeywell will have no liability for any damages arising out of your use or modification to, the literature. You will defend and indemnify Honeywell, its affiliates and subsidiaries, from and against any liability, cost, or damages, including attorneys' fees, arising out of, or resulting from, any modification to the literature by you.

Automation and Control Solutions

Honeywell International Inc.
1985 Douglas Drive North
Golden Valley, MN 55422
customer.honeywell.com

© U.S. Registered Trademark
© 2012 Honeywell International Inc.
63-2627—02 M.S. Rev. 10-12
Printed in United States

Honeywell