

Wire Management Products

Cord and Cable Reels

Weatherproof Cord Reels

Features

- Durable, Corrosion Resistant Cast Aluminum Construction
- UL Type 4
- Multi-Position Guide Arm can be mounted in two different positions
- Positive Latch mechanism automatically maintains desired cord length
- Ratchet Lock can be disengaged in field for constant tension applications

Ordering Information

Description	UPC	Catalog Number
White Weatherproof Reel, UL Type 4, 40 Ft, #12/4 SOW, 20 A, 600 VAC	783585585987	HBLW40124W

Listings

cULus Listed

Specifications

Spool	Aluminum
Guide Frame	Thermoplastic
Cord	Copper
Internal Terminals	Copper Alloy
Ball Stopper	Thermoplastic
Fitting	Aluminum

Performance

Electrical	
Amperage	20 A
Max. Working Voltage	600V AC
Number of Wires	4-Wire

Environmental

Moisture Resistance	Dry, Indoor and Wet and Damp Outdoor, Non-Hazardous Locations - UL Type 4
---------------------	---

HUBBELL

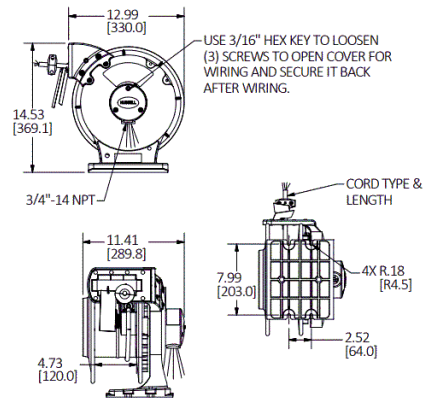

Complementary Products

Pivot Base	HBLI340PB
Mounting Bracket	HBLIMB
Ball Stop	HBLI10BS

Online Resources

Customer Sales Drawing
eCatalog
Installation Instructions

Dimensions in Inches (mm)

Specifications subject to change without notice.

