

**SLC30 Series – Panel Mounted Annunciators**

**SLC Series Panel Mounted Annunciators – an Ideal Alternative to Mounting Multiple Pilot Devices**

**Cluster mounting simplifies panel cutouts and offers a variety of window combination sizes!**

Available with incandescent or Superbright LED illumination.

Key features of the SLC30 series include:

- Custom configurations with up to 200 windows
- Five window sizes based on a 30mm grid
- Non-reflective clear lenses
- Incandescent or Superbright LED illumination
- Wide variety of input voltages
- Two color alternate illumination in Red/Green LED

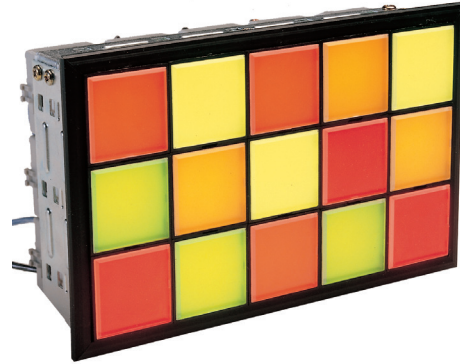

**Style F**  
(30mm x 30mm)



**Style H**  
(30mm x 60mm)



**Style L**  
(30mm x 90mm)



**Style V**  
(60mm x 30mm)



**Style G**  
(60mm x 60mm)

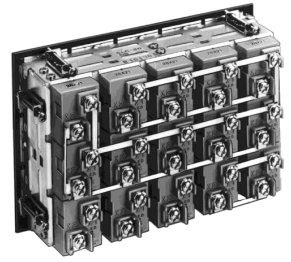

**Staggered Terminals:**  
increased safety  
and serviceability

Switches & Pilot Lights

Signaling Lights

Relays & Sockets







Timers

Contactors

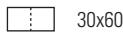
Terminal Blocks

Circuit Breakers

## Specifications



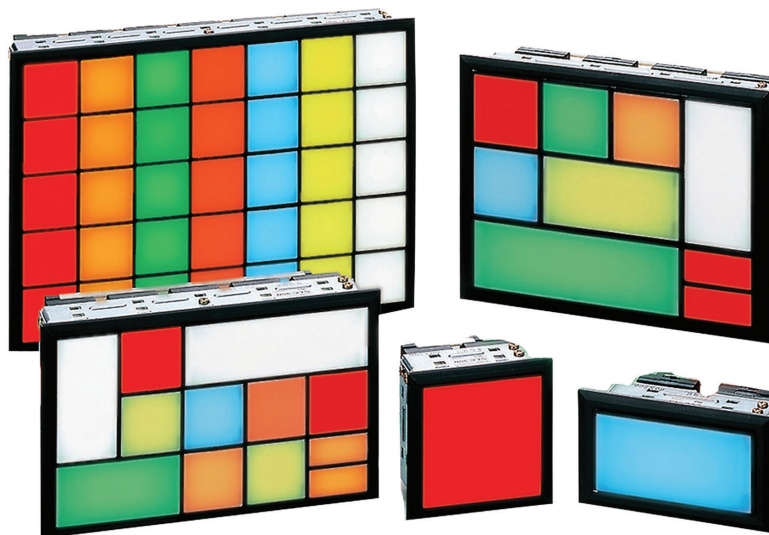

Light Source		LED	Incandescent
Nominal Voltages	Full Voltage	6, 12, 24V AC/DC	6, 12, 18, 24, 30V AC/DC
	Transformer	120, 240V AC	120, 240V AC
	DC-DC Conv.	110V DC	110V DC
Colors		Amber, Green, Red, Yellow, Blue (24V only), White, dual color Red/Green (24V only)	Amber, Green, Red, Yellow, Blue, White
Lamp Type		Surface (Chip type) LED cluster	BA9S/13 (T3-1/4) bayonet base (1W)
Current Consumption	6V DC	Red (R), Green (G), Yellow (Y), Amber (A), White (W): 80mA	
	12V DC	Red (R), Green (G), Yellow (Y), Amber (A), White (W): 40mA	
	24V DC	Red (R), Green (G), Yellow (Y), Amber (A), White (W), Blue (S): 20mA	
Available Window Sizes		<div style="display: flex; justify-content: space-around; align-items: flex-end;"> <div style="text-align: center;"> <p>"F"</p>  <p>30x30mm</p> </div> <div style="text-align: center;"> <p>"H"</p>  <p>30x60mm</p> </div> <div style="text-align: center;"> <p>"L"</p>  <p>30x90mm</p> </div> <div style="text-align: center;"> <p>"V"</p>  <p>60x30mm</p> </div> <div style="text-align: center;"> <p>"G"</p>  <p>60x60mm</p> </div> </div>	
Insulation Resistance		More than 100 MΩ by a 500V DC megger	
Degree of Protection		IP20 (for indoor use only)	
Dielectric Strength		2,000V AC direct (2,500V AC transformer, 1 minute)	
Operating Temperature		- 20° to +40°C; 15-90% relative humidity (- 10° to +40°C DC-DC converter)	
Material of Marking Plate and Color Screen		Polycarbonate	
Termination		M3.5 screw with captive sems plate (Check terminals: M3 screw with captive sems plate on applicable units)	
Maximum Size		Full voltage 10 rows, 20 columns (200 windows) Transformer and DC/DC converter (50 windows)	
Recommended Wire Size		22-14 AWG x2 (2mm <sup>2</sup> x 2)	
Approvals		<div style="display: flex; justify-content: space-around; align-items: center;"> <div style="text-align: center;">  <p>Cert. No. B970213332375</p> </div> <div style="text-align: center;">  <p>UL Recognized File No. E68961</p> <p><b>ABS</b> American Bureau of Shipping</p> </div> <div style="text-align: center;">  <p>CSA Certified File No. LR48366</p> </div> </div>	

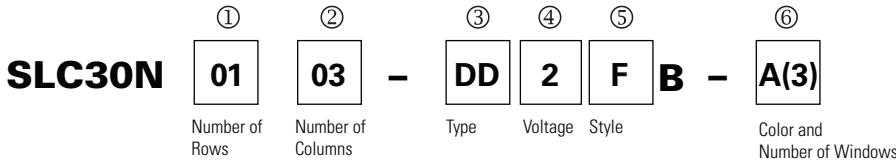

Part Numbers (assembled)

Part Number Guide



Description		Code	Remark	
① Number of Rows		01, 02, 03, 04, 05, 06, 07, 08, 09, 10	10 row maximum (always expressed in terms of "F" size windows)	
② Number of Columns		01, 02, 03, 04, 05, 06, 07, 08, 09, 10, 11, 12, 13, 14, 15, 16, 17, 18, 19, 20	20 column maximum (always expressed in terms of "F" size windows)	
③ Type	LED	Full voltage	DD	6V, 12V, 24V
		Full voltage with check terminal	DHM	24V only
		Full voltage 2 color (Red/Green)	DW	24V only
		Transformer	TD	120V, 240V AC
		DC-DC converter	CD	110V DC only
	Incandescent	Full voltage	DS	6V, 12V, 18V, 24V, 30V
		Transformer	TS	120V, 240V
④ Voltage	6V AC/DC	6	Type DD or DS	
	12V AC/DC	1	With Type DD or DS	
	18V AC/DC	8	Type DS only	
	24V AC/DC	2	Type DD, DW, DS or DHM	
	30V AC/DC	3	Type DS only	
	120V AC	12	Type TD or TS	
	240V AC	24	Type TD or TS	
	110V DC	1	With Type CD	
	No lamp	99	Type DS only	
⑤ Style	Square	F	 30x30mm	
	Horizontal rectangle	H	 30x60mm	
	Horizontal rectangle with barrier	H2		
	Large horizontal rectangle	L	 30x90mm	
	Vertical rectangle	V	 60x30mm	
	Large square	G	 60x60mm	
	Combination	M	Fill out order form on next page	
⑥ Color (number of windows)	Amber	A	After each color, specify the number of windows Example... A(3), G(2), R(1)	
	Green	G		
	Red	R		
	Blue	S (LED version: 24V only)		
	White	W		
	Yellow	Y		

- Secondary voltage on transformers and DC-DC converters is 24V.
- To specify arrangement of varying window sizes and colors, use the order form on the next page.
- Drawing required for any units ordered with engraving.
- Incandescent models use color screen and marking plate, LED models use 2 marking plates (no color screen).

Order Form

Purchase Order No. \_\_\_\_\_ Date \_\_\_\_\_ Sheet  of

Fill in Part Number Below:

Number of Amber  
 Number of Green  
 Number of Red  
 Number of Blue  
 Number of White  
 Number of Yellow

Contact \_\_\_\_\_  
 Company \_\_\_\_\_  
 Phone # \_\_\_\_\_  
 Ship to \_\_\_\_\_  
 City/State/Zip \_\_\_\_\_

SLC30N

Number of Rows     
 Number of Columns

Type Code   
 Operating Voltage   
 Style Code

B- Black Frame

Note: Convert all window styles to the style F (basic unit size).

- F = One Window
- H = Two Windows Wide
- L = Three Windows Wide
- V = Two Windows High
- G = Two x Two
- M = Multiple Combination

Remarks:

\_\_\_\_\_

First Window (upper, left-hand corner of panel)

Basic Unit Size (style F)

THIS SIDE UP

COLUMNS

ROWS

Quantity \_\_\_\_\_

Note: All units ordered with one order form must be identical

For engraving information, see page 715.

For information on how to complete the order form or to view examples, see the following page.

THIS SIDE UP

1. For part number development, see the previous page.
2. Panel cutout dimensions are on page 697.
3. Additional ordering information is on page 696.



**How to complete SLC30N Series annunciator order form:**

1. Draw the SLC30N layout in the Order Form as per customer requirements. Define the boundaries of each window (F, V, H, L or G Style) and of complete annunciator panel by heavy border lines. Specify each window color with appropriate designation (eg: G for Green, R for Red, etc). See Example 1 below:

**Example 1**

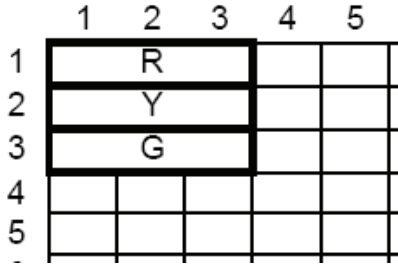

2. Count number of rows and columns. eg: Example 1, Rows: 03 and Columns: 03

**SLC30N-0303**

3. Determine the type of illumination required. eg: "DD" for LED full voltage type illumination.

**SLC30N-0303-DD**

4. Determine the voltage code. eg: "2" for 24V AC/DC.

**SLC30N-0303-DD2**

5. Determine window style. eg: "L" style windows as shown in Example 1.

**SLC30N-0303-DD2LB\***

\*B denotes black frame

6. Count the number of different colored windows in the annunciator. Example 1 has 1 Red L-style (30x90mm) window, 1 Yellow L-style window and 1 Green L-style window.

**SLC30N-0303-DD2LB-R(1)Y(1)G(1)**

7. Now your part number is complete, please fill out contact information and fax or email the form to IDEC Customer Service for order processing. If you would like to get annunciator windows engraved, please see the information on page 828 and send us your engraving information. If you have any questions, please contact IDEC Technical Support or for additional information, view examples 2 and 3:

**Example 2**

Rows=03; Columns= 03; F Style Windows (30x30mm); LED Full Voltage 24V AC/DC Illumination. Part number **SLC30N-0303-DD2FB-R(3)Y(3)G(3)**.

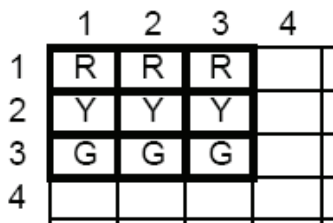

**Example 3:**

Rows = 04; Columns = 05; M = combination of various window styles(F, H, L V and G Style) ; LED Full Voltage 24V AC/DC Illumination.

Part number **SLC30N-0405-DD2MB-A(1)R(2)Y(1)G(1)W(2)S(2)**.

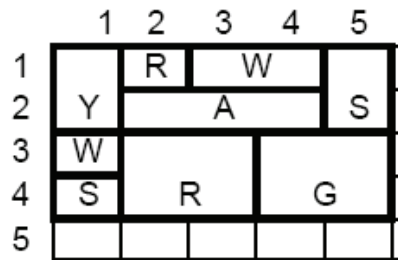

Dimensions

Panel Cut-Out Dimensions

No. of Rows	No. of Columns		1	2	3	4	5	6	7	8	9	10	11	12	13	14	15	16	17	18	19	20
	Overall Panel Width Dimension →		1.654" (42mm)	2.853" (72mm)	4.016" (102mm)	5.197" (132mm)	6.378" (162mm)	7.559" (192mm)	8.740" (222mm)	9.921" (252mm)	11.102" (282mm)	12.283" (312mm)	13.465" (342mm)	14.646" (372mm)	15.827" (402mm)	17.008" (432mm)	18.189" (462mm)	19.370" (492mm)	20.551" (522mm)	21.732" (552mm)	22.913" (582mm)	24.094" (612mm)
	Overall Height ↓	Cut-out Ht ↓	Cut-out Wd ↓	1.378" (35mm)	2.559" (65mm)	3.740" (95mm)	4.921" (125mm)	6.102" (155mm)	7.283" (185mm)	8.465" (215mm)	9.646" (245mm)	10.827" (275mm)	12.008" (305mm)	13.189" (335mm)	14.370" (365mm)	15.551" (395mm)	16.732" (425mm)	17.913" (455mm)	19.094" (485mm)	20.276" (515mm)	21.457" (545mm)	22.638" (575mm)
1	1.654" (42mm)	1.378" (35mm)	1	2	3	4	5	6	7	8	9	10	11	12	13	14	15	16	17	18	19	20
2	2.853" (72mm)	2.559" (65mm)	2	4	6	8	10	12	14	16	18	20	22	24	26	28	30	32	34	36	38	40
3	4.016" (102mm)	3.740" (95mm)	3	6	9	12	15	18	21	24	27	30	33	36	39	42	45	48	51	54	57	60
4	5.197" (132mm)	4.921" (125mm)	4	8	12	16	20	24	28	32	36	40	44	48	52	56	60	64	68	72	76	80
5	6.378" (162mm)	6.102" (155mm)	5	10	15	20	25	30	35	40	45	50	55	60	65	70	75	80	85	90	95	100
6	7.559" (192mm)	7.283" (185mm)	6	12	18	24	30	36	42	48	54	60	66	72	78	84	90	96	102	108	114	120
7	8.740" (222mm)	8.465" (215mm)	7	14	21	28	35	42	49	56	63	70	77	84	91	98	105	112	119	126	133	140
8	9.921" (252mm)	9.646" (245mm)	8	16	24	32	40	48	56	64	72	80	88	96	104	112	120	128	136	144	152	160
9	11.102" (282mm)	10.827" (275mm)	9	18	27	36	45	54	63	72	81	90	99	108	117	126	135	144	153	162	171	180
10	12.283" (312mm)	12.008" (305mm)	10	20	30	40	50	60	70	80	90	100	110	120	130	140	150	160	170	180	190	200

Total Number of Windows (equivalent to style F—basic unit size)



- The number of rows and columns refers to styles equivalent to style F (basic unit size).  
For styles H, L, V, and G, convert into style F (basic unit size) equivalents.  
Style H: 1 window high (1 row) x 2 windows wide (2 columns)  
Style V: 2 windows high (2 rows) x 1 window wide (1 column)  
Style L: 1 window high (1 row) x 3 windows wide (3 columns)  
Style G: 2 windows high (2 rows) x 2 windows wide (2 columns)  
Example: 18 windows = 3 windows high (3 rows) x 6 windows wide (6 columns)  
Overall dimension (H x W): 4.016" x 7.559" (102 x 192mm)  
Panel cut-out (H x W): 3.740" x 7.283" (95 x 185mm)  
Tolerance: +0.039" (1mm), -0
- For part numbering information, see page 806.

Window Dimensions

Window Style	Style F	Style H	Style L	Style V	Style G	
Appearance						
Window Size	Illumination Face (H x W)	1.181" x 1.181" (30 x 30mm)	1.181" x 2.362" (30 x 60mm)	1.181" x 3.543" (30 x 90mm)	2.362" x 1.181" (60 x 30mm)	2.362" x 2.362" (60 x 60mm)
	Lens (H x W)	1.102" x 1.102" (28 x 28mm)	1.102" x 2.283" (28 x 58mm)	1.102" x 3.432" (28 x 88mm)	2.283" x 1.102" (58 x 28mm)	2.283" x 2.283" (58 x 58mm)
	Marking Plate (H x W x t)	1.062" x 1.062" x 0.04" (27 x 27 x 1.0mm)	1.062" x 2.244" x 0.04" (27 x 57 x 1.0mm)	1.062" x 3.425" x 0.04" (27 x 87 x 1.0mm)	2.244" x 1.062" x 0.04" (57 x 27 x 1.0mm)	2.244" x 2.244" x 0.04" (57 x 57 x 1.0mm)
	Color Screen (H x W x t)	1.062" x 1.062" x 0.04" (27 x 27 x 1.0mm)	1.062" x 2.244" x 0.04" (27 x 57 x 1.0mm)	1.062" x 3.425" x 0.04" (27 x 87 x 1.0mm)	2.244" x 1.062" x 0.04" (57 x 27 x 1.0mm)	2.244" x 2.244" x 0.04" (57 x 57 x 1.0mm)
	Engraving Area	0.984" x 0.984" (25 x 25mm)	0.984" x 2.165" (25 x 55mm)	0.984" x 3.346" (25 x 85mm)	2.165" x 0.984" (55 x 25mm)	2.165" x 2.165" (55 x 55mm)

Switches & Pilot Lights

Signaling Lights

Relays & Sockets

Timers

Contactors

Terminal Blocks

Circuit Breakers

Dimensions, continued

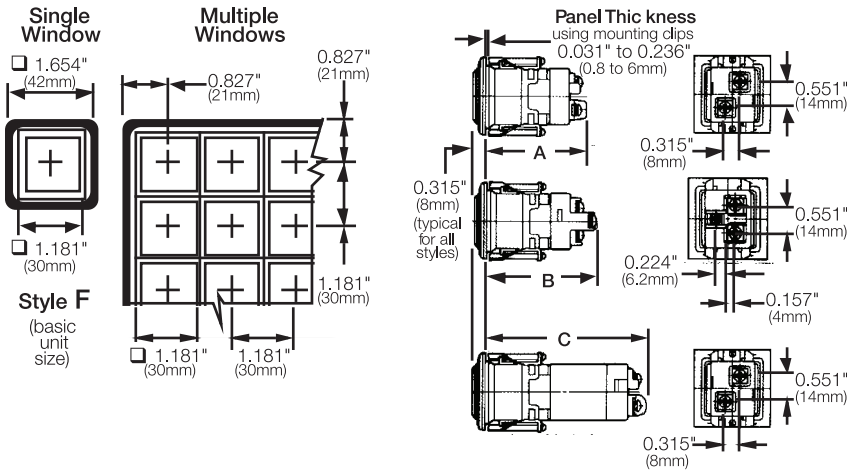

Styles F, H, L, V, G:  
Single Window (right)  
Multiple Windows (below)

	Description	LED	Incandescent
A	Full voltage	2.146" (54.5mm)	2.264" (57.5mm)
	Full voltage LED 2-color alternate	2.343" (59.5mm)	—
C	Transformer	3.228" (82mm)	—
	DC-DC converter	3.228" (82mm)	—
	Transformer	—	3.228" (82mm)
Terminals (X1, X2)		M3.5 screw	
Check terminal (C)		M3 screw	
Same terminals, adjacent windows		1.181" (30mm) centers	

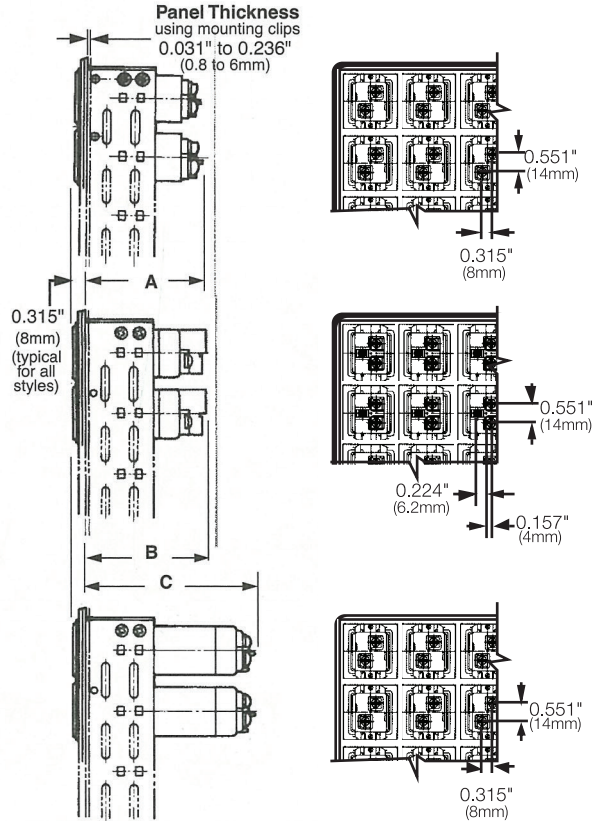
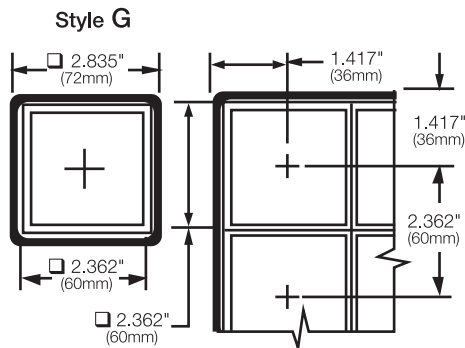
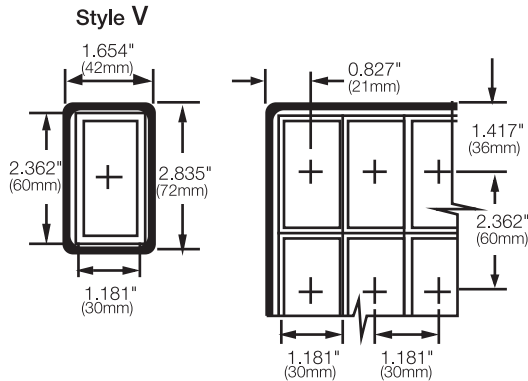
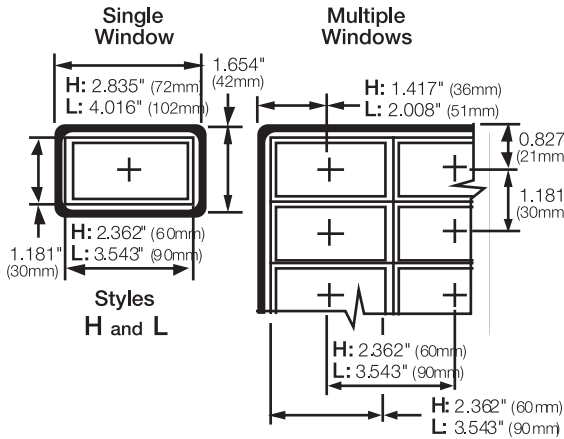

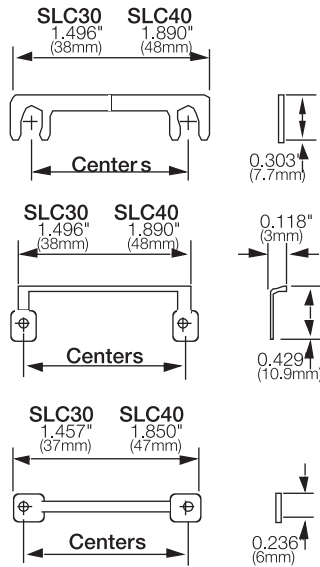

## Dimensions, continued

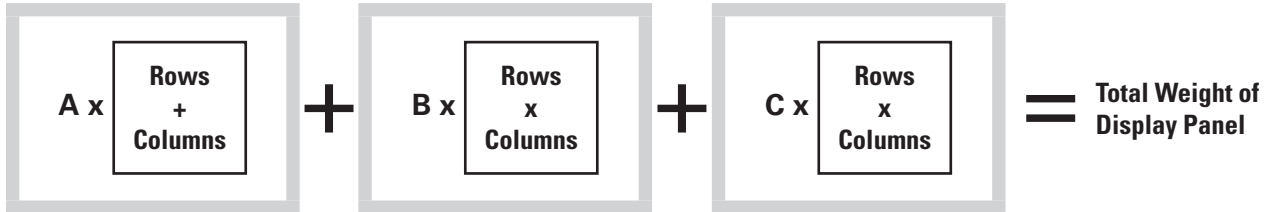

## Instructions

### Estimating Weights



 1. Make sure that the panel thickness is sufficient to support the total weight of the display panel(s).

A Frame Weight	B Housing Weight	Full Voltage	Transformer (incandescent/LED)	DC-DC Converter (LED only)
		C Lamp/LED Weight (includes lamp/LED)		
0.68oz (22g)	0.53oz (17g)	0.65oz (21g)	2.36oz (76g)	1.77oz (52g)

 2. Weights are approximate.

Example:  
 SLC30N-0304-DD2FB  
 Total weight = A (rows + columns) + B (rows x columns) + C (rows x columns)  
 Total weight = 0.68 (3+4) + 0.53 (3x4) + 0.65 (3x4) = 19.92 oz