

SPECIFICATIONS MINI-LINE STYLE I RECEPTACLES (2-6 POLE)

- Male and Female Receptacles
- Standard Color Code
- 16 AWG Pigtail Leads
- 600V 105°C
- Straight and Right Angle Versions
- Hardware Options Below
- Meets Current SAE #H1738-2 Specifications



TECHNICAL DATA

Agency Approvals

UL Recognition:
CSA Certification:

File #E169897
File #LR13963

Electrical Data

Contact Resistance:
Current Rating:

$\leq 5m\Omega$
See chart with part
number detail

Voltage Rating:
Dielectric Withstand Voltage:

600 VAC / 600 VDC
2200 VAC

Environmental Data

Protection:
Temperature Range:
High Pressure Water Test:

NEMA 1, 3, 4, 6P and 13; IEC IP 68
-30°C to +105°C
1200 PSI spray

Material Data

Insert:
Pigtail leads:
Contacts:
Receptacle Shell:



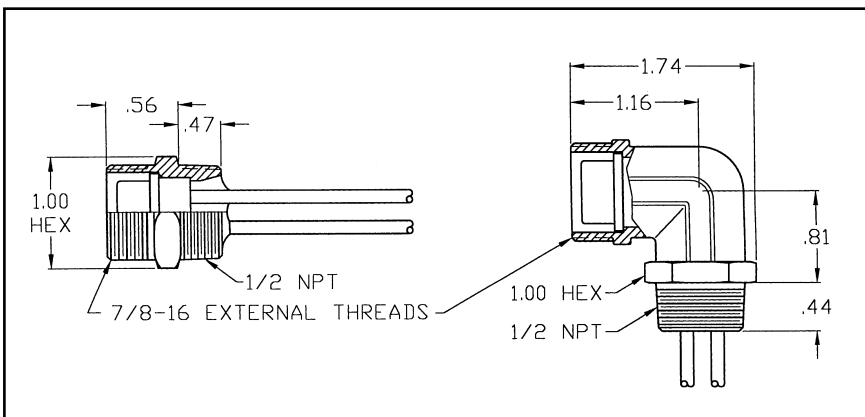

Yellow, 90A durometer, flame resistant PVC
Color Coded type MTW or AWM style 1015/1230
Machined Brass per ASTM B-16
Diecast Zamak 5 Zinc plated with clear sealer
Nylon 6/6 weather stabilized
303 Stainless Steel (except right angle design)
Black rigid epoxy

Potting Compound:

DIMENSIONS



MINI-LINE FEMALE RECEPTACLE WITH ZINC DIECAST RECEPTACLE SHELL





POLES	FACE VIEW FEMALE	COLOR CODE	RATING	AWG	LEAD LENGTH	STRAIGHT	RIGHT ANGLE
2		1. White 2. Black	600V, 13A	16	10"	5000108-9	5000108-17
3		1. Green 2. Black 3. White	600V, 13A	16	10"	5000109-9	5000109-17
4		1. Black 2. White 3. Red 4. Green	600V, 10A	16	10"	5000110-9	5000110-17
5		1. White 2. Red 3. Green 4. Orange 5. Black	600V, 8A	16	10"	5000111-9	5000111-17
6		1. White 2. Red 3. Green 4. Orange 5. Black 6. Blue	600V, 6A	16	10"	5000120-9	5000120-17

MINI-LINE MALE RECEPTACLE WITH ZINC DIECAST RECEPTACLE SHELL





POLES	FACE VIEW MALE	COLOR CODE	RATING	AWG	LEAD LENGTH	STRAIGHT	RIGHT ANGLE
2		1. White 2. Black	600V, 13A	16	10"	5000108-10	5000108-18
3		1. Green 2. Black 3. White	600V, 13A	16	10"	5000109-10	5000109-18
4		1. Black 2. White 3. Red 4. Green	600V, 10A	16	10"	5000110-10	5000110-18
5		1. White 2. Red 3. Green 4. Orange 5. Black	600V, 8A	16	10"	5000111-10	5000111-18
6		1. White 2. Red 3. Green 4. Orange 5. Black 6. Blue	600V, 6A	16	10"	5000120-10	5000120-18

Note: Special lead lengths available upon request — consult factory.

MINI-LINE FEMALE RECEPTACLE WITH *NYLON* RECEPTACLE SHELL





POLES	FACE VIEW FEMALE	COLOR CODE	RATING	AWG	LEAD LENGTH	STRAIGHT	RIGHT ANGLE
2		1. White 2. Black	600V, 13A	16	10"	5000108-9N	5000108-17N
3		1. Green 2. White 3. Black	600V, 13A	16	10"	5000109-9N	5000109-17N
4		1. Black 2. White 3. Red 4. Green	600V, 10A	16	10"	5000110-9N	5000110-17N
5		1. White 2. Red 3. Green 4. Orange 5. Black	600V, 8A	16	10"	5000111-9N	5000111-17N
6		1. White 2. Red 3. Green 4. Orange 5. Black 6. Blue	600V, 6A	16	10"	5000120-9N	5000120-17N

MINI-LINE MALE RECEPTACLE WITH *NYLON* RECEPTACLE SHELL





POLES	FACE VIEW MALE	COLOR CODE	RATING	AWG	LEAD LENGTH	STRAIGHT	RIGHT ANGLE
2		1. White 2. Black	600V, 13A	16	10"	5000108-10N	5000108-18N
3		1. Green 2. Black 3. White	600V, 13A	16	10"	5000109-10N	5000109-18N
4		1. Black 2. White 3. Red 4. Green	600V, 10A	16	10"	5000110-10N	5000110-18N
5		1. White 2. Red 3. Green 4. Orange 5. Black	600V, 8A	16	10"	5000111-10N	5000111-18N
6		1. White 2. Red 3. Green 4. Orange 5. Black 6. Blue	600V, 6A	16	10"	5000120-10N	5000120-18N

Note: Special lead lengths available upon request — consult factory.

MINI-LINE FEMALE RECEPTACLE WITH STAINLESS STEEL RECEPTACLE SHELL

POLES	FACE VIEW FEMALE	COLOR CODE	RATING	AWG	LEAD LENGTH	STRAIGHT
2		1. White 2. Black	600V, 13A	16	10"	5000108-9X
3		1. Green 2. White 3. Black	600V, 13A	16	10"	5000109-9X
4		1. Black 2. White 3. Red 4. Green	600V, 10A	16	10"	5000110-9X
5		1. White 2. Red 3. Green 4. Orange 5. Black	600V, 8A	16	10"	5000111-9X
6		1. White 2. Red 3. Green 4. Orange 5. Black 6. Blue	600V, 6A	16	10"	5000120-9X

MINI-LINE MALE RECEPTACLE WITH STAINLESS STEEL RECEPTACLE SHELL

POLES	FACE VIEW MALE	COLOR CODE	RATING	AWG	LEAD LENGTH	STRAIGHT
2		1. White 2. Black	600V, 13A	16	10"	5000108-10X
3		1. Green 2. Black 3. White	600V, 13A	16	10"	5000109-10X
4		1. Black 2. White 3. Red 4. Green	600V, 10A	16	10"	5000110-10X
5		1. White 2. Red 3. Green 4. Orange 5. Black	600V, 8A	16	10"	5000111-10X
6		1. White 2. Red 3. Green 4. Orange 5. Black 6. Blue	600V, 6A	16	10"	5000120-10X

Note: Special lead lengths available upon request — consult factory.