

CHANGE-OUT CONNECTORS

**“THE
TOUGH LINE
FOR TOUGH
JOBS”**

Crouse-Hinds Change-Out connectors provide superior service for your tough industrial environments. Our factory molded-to-cable design provides rugged, sealed construction. The resilient one-piece molded construction shrugs off heavy physical abuse while maintaining an environmental seal.

Cable and hardware options allow easy design improvements to meet your application requirements. Connector and receptacle pigtail lead lengths available to meet your specific requirements upon request.

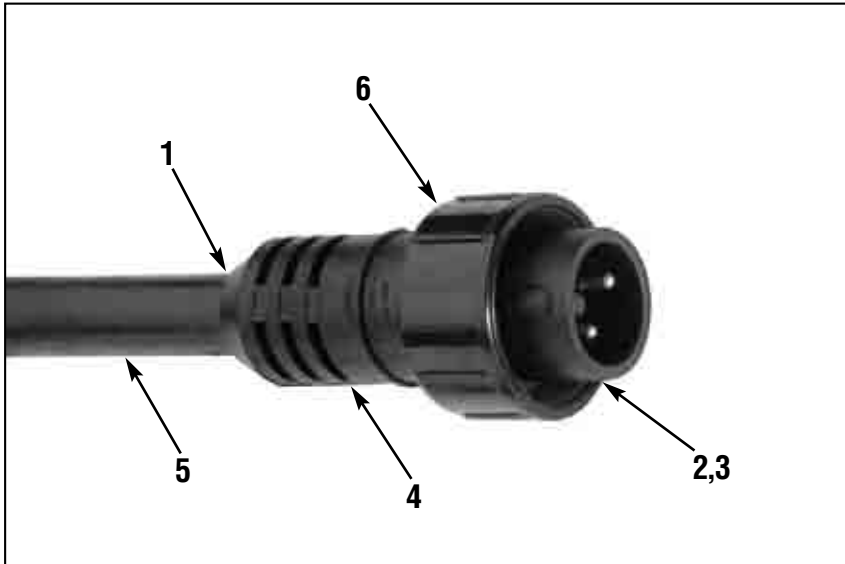

FEATURES & BENEFITS

- 1 **Connector-to-cable molded junction** securely bonds for excellent reliability
- 2 **Molded keyway** design facilitates proper alignment reducing mismatching damage
- 3 **Shroud and cork** design seals out moisture ensuring environmental protection to IP-68 and NEMA-6P requirements
- 4 **Thermoplastic or thermoset** compound options available to support your most severe environment applications for oils, acids, coolants and other contaminants
- 5 **Easy stripping PVC jacketed cable** with “fillerless” design allows fast stripping with simple hand tools.
Cable options available for industrial applications with the following types:
 - **STOOW cable** with PVC jacket having oil resistant jacket and conductors
 - **SEOW “TPE” cable** with oil resistant jacket/conductors having elastomer jacket
 - **“SO” cable** with oil resistant and low temperature jacket
- 6 Hardware available with **zinc diecast or nylon** coupling nuts/receptacle shells
- 7 **Receptacle shells** available with 1/2 and 3/4 pipe threads for 2 through 9 pin configurations.
- 8 Every unit is **100% electrically tested** using state of the art automated test equipment.

SPECIFICATIONS CHANGE-OUT PLUGS

Series A

- 2-9 Pole Configurations
- 2-4 Pole; #14 AWG, 12 AWG, 10 AWG
- 5-9 Pole; #18 AWG
- Nylon or Zinc Diecast Hardware

Series B

- 2-8 Pole Configurations
- 2-7 Pole; #10 AWG
- 8 Pole; #14 AWG
- Anodized Aluminum Hardware



TECHNICAL DATA

Agency Approvals

UL Recognition:
CSA Recognition:

File #E169897
File #LR13963

Electrical Data

Current Rating:
Voltage Rating:
Dielectric Withstand Voltage:

See chart with part number detail
See chart with part number detail
2200 VAC

Environmental Data

Protection:

Temperature Range:

NEMA 1, 3, 4, 6P and 13; IEC IP 68
(Nylon: NEMA 4X, Hose down pressure 1000 PSI)
-20°C to +105°C

Material Data



Body:
Cable:
Contacts:
Coupling Nut:

Black flame resistant PVC, Neoprene
STOOW, SO
Series A Machined Brass; Series B copper
Series A Zamak, nylon 6/6 weather stabilized
Series B Machined Aluminum

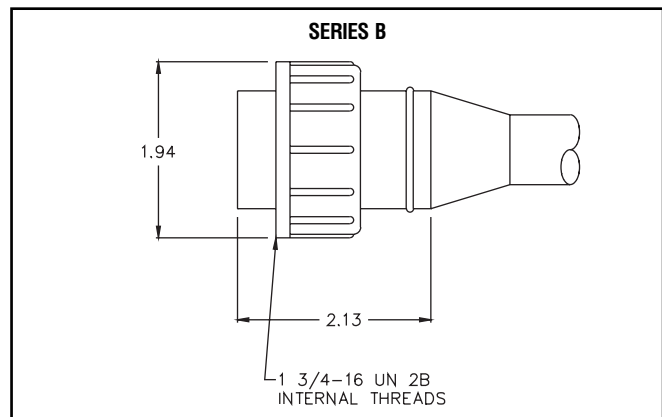
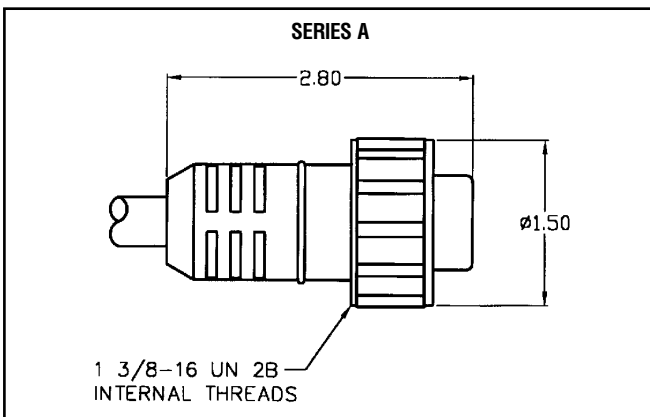

DIMENSIONS





CHANGE-OUT SERIES A STOOW FEMALE PLUGS WITH ZINC DIECAST COUPLING NUT

POLES	FACE VIEW FEMALE	COLOR CODE	RATING	AWG	CABLE LENGTH	PART NUMBER
2		1. Black 2. White	600V, 18A	14	6' 12' 18'	X8651-49P X8651-50P X8651-51P
3		1. Black 2. White 3. Green	600V, 18A	14	6' 12' 18'	X8652-48P X8652-49P X8652-50P
4		1. Black 2. Green 3. Red 4. White	600V, 15A	14	6' 12' 18'	X8653-44P X8653-45P X8653-46P

CHANGE-OUT SERIES A STOOW MALE PLUGS WITH ZINC DIECAST COUPLING NUT



POLES	FACE VIEW MALE	COLOR CODE	RATING	AWG	CABLE LENGTH	PART NUMBER
2		1. Black 2. White	600V, 18A	14	6' 12' 18'	X8651-52P X8651-53P X8651-54P
3		1. Black 2. White 3. Green	600V, 18A	14	6' 12' 18'	X8652-51P X8652-52P X8652-53P
4		1. Black 2. Green 3. Red 4. White	600V, 15A	14	6' 12' 18'	X8653-47P X8653-48P X8653-49P

CHANGE-OUT SERIES A STOOW FEMALE PLUGS WITH NYLON COUPLING NUT



POLES	FACE VIEW FEMALE	COLOR CODE	RATING	AWG	CABLE LENGTH	PART NUMBER
2		1. Black 2. White	600V, 18A	14	6' 12' 18'	X8651-78P X8651-80P X8651-82P
3		1. Black 2. White 3. Green	600V, 18A	14	6' 12' 18'	X8652-92P X8652-94P X8652-96P
4		1. Black 2. Green 3. Red 4. White	600V, 15A	14	6' 12' 18'	X8653-92P X8653-94P X8653-96P

Note: Special lengths available upon request — consult factory.



CHANGE-OUT SERIES A STOOW MALE PLUGS WITH NYLON COUPLING NUT

POLES	FACE VIEW MALE	COLOR CODE	RATING	AWG	CABLE LENGTH	PART NUMBER
2		1. Black 2. White	600V, 18A	14	6' 12' 18'	X8651-79P X8651-81P X8651-83P
3		1. Black 2. White 3. Green	600V, 18A	14	6' 12' 18'	X8652-93P X8652-95P X8652-97P
4		1. Black 2. Green 3. Red 4. White	600V, 15A	14	6' 12' 18'	X8653-93P X8653-95P X8653-97P

CHANGE-OUT SERIES A STOOW FEMALE PLUGS WITH ZINC DIECAST COUPLING NUT



POLES	FACE VIEW FEMALE	COLOR CODE	RATING	AWG	CABLE LENGTH	PART NUMBER
2		1. Black 2. White	600V, 25A	12	6' 12' 18'	X8651-528P X8651-529P X8651-644P
3		1. Black 2. White 3. Green	600V, 25A	12	6' 12' 18'	X8652-528P X8652-529P X8652-644P
4		1. Black 2. Green 3. Red 4. White	600V, 20A	12	6' 12' 18'	X8653-528P X8653-529P X8653-644P

CHANGE-OUT SERIES A STOOW MALE PLUGS WITH ZINC DIECAST COUPLING NUT



POLES	FACE VIEW MALE	COLOR CODE	RATING	AWG	CABLE LENGTH	PART NUMBER
2		1. Black 2. White	600V, 25A	12	6' 12' 18'	X8651-516P X8651-517P X8651-640P
3		1. Black 2. White 3. Green	600V, 25A	12	6' 12' 18'	X8652-516P X8652-517P X8652-640P
4		1. Black 2. Green 3. Red 4. White	600V, 20A	12	6' 12' 18'	X8653-516P X8653-517P X8653-640P

Note: Special lengths available upon request — consult factory.



CHANGE-OUT SERIES A STOOW FEMALE PLUGS WITH NYLON COUPLING NUT

POLES	FACE VIEW FEMALE	COLOR CODE	RATING	AWG	CABLE LENGTH	PART NUMBER
2		1. Black 2. White	600V, 25A	12	6' 12' 18'	X8651-1528P X8651-1529P X8651-1644P
3		1. Black 2. White 3. Green	600V, 25A	12	6' 12' 18'	X8652-1528P X8652-1529P X8652-1644P
4		1. Black 2. Green 3. Red 4. White	600V, 20A	12	6' 12' 18'	X8653-1528P X8653-1529P X8653-1644P

CHANGE-OUT SERIES A STOOW MALE PLUGS WITH NYLON COUPLING NUT



POLES	FACE VIEW MALE	COLOR CODE	RATING	AWG	CABLE LENGTH	PART NUMBER
2		1. Black 2. White	600V, 25A	12	6' 12' 18'	X8651-1516P X8651-1517P X8651-1640P
3		1. Black 2. White 3. Green	600V, 25A	12	6' 12' 18'	X8652-1516P X8652-222P X8652-1640P
4		1. Black 2. Green 3. Red 4. White	600V, 20A	12	6' 12' 18'	X8653-1516P X8653-1517P X8653-1640P

CHANGE-OUT SERIES A STOOW FEMALE PLUGS WITH ZINC DIECAST COUPLING NUT



POLES	FACE VIEW FEMALE	COLOR CODE	RATING	AWG	CABLE LENGTH	PART NUMBER
2		1. Black 2. White	600V, 30A	10	6' 12' 18'	X8651-645P X8651-646P X8651-647P
3		1. Black 2. White 3. Green	600V, 30A	10	6' 12' 18'	X8652-645P X8652-646P X8652-647P
4		1. Black 2. Green 3. Red 4. White	600V, 25A	10	6' 12' 18'	X8653-645P X8653-646P X8653-647P

Note: Special lengths available upon request — consult factory.



CHANGE-OUT SERIES A STOOV MALE PLUGS WITH ZINC DIECAST COUPLING NUT

POLES	FACE VIEW MALE	COLOR CODE	RATING	AWG	CABLE LENGTH	PART NUMBER
2		1. Black 2. White	600V, 30A	10	6' 12' 18'	X8651-641P X8651-642P X8651-643P
3		1. Black 2. White 3. Green	600V, 30A	10	6' 12' 18'	X8652-641P X8652-642P X8652-643P
4		1. Black 2. Green 3. Red 4. White	600V, 25A	10	6' 12' 18'	X8653-641P X8653-642P X8653-643P

CHANGE-OUT SERIES A STOOV FEMALE PLUGS WITH NYLON COUPLING NUT



POLES	FACE VIEW FEMALE	COLOR CODE	RATING	AWG	CABLE LENGTH	PART NUMBER
2		1. Black 2. White	600V, 30A	10	6' 12' 18'	X8651-1645P X8651-1646P X8651-1647P
3		1. Black 2. White 3. Green	600V, 30A	10	6' 12' 18'	X8652-1645P X8652-1646P X8652-1647P
4		1. Black 2. Green 3. Red 4. White	600V, 25A	10	6' 12' 18'	X8653-1645P X8653-1646P X8653-1647P

CHANGE-OUT SERIES A STOOV MALE PLUGS WITH NYLON COUPLING NUT



POLES	FACE VIEW MALE	COLOR CODE	RATING	AWG	CABLE LENGTH	PART NUMBER
2		1. Black 2. White	600V, 30A	10	6' 12' 18'	X8651-1641P X8651-1642P X8651-1643P
3		1. Black 2. White 3. Green	600V, 30A	10	6' 12' 18'	X8652-1641P X8652-1642P X8652-1643P
4		1. Black 2. Green 3. Red 4. White	600V, 25A	10	6' 12' 18'	X8653-1641P X8653-1642P X8653-1643P

Note: Special lengths available upon request — consult factory.

CHANGE-OUT SERIES A "SO" FEMALE PLUGS WITH ZINC DIECAST COUPLING NUT





POLES	FACE VIEW FEMALE	COLOR CODE	RATING	AWG	CABLE LENGTH	PART NUMBER
5		1. Red	300V, 6A	18	6'	X8872-5A
		2. White			12'	X8872-7A
		3. Black			18'	X8872-9A
6		1. Red	300V, 6A	18	6'	X8871-5A
		2. White			12'	X8871-7A
		3. Black			18'	X8871-9A
7		1. Red	300V, 5A	18	6'	X8870-5A
		2. White			12'	X8870-8A
		3. Black			18'	X8870-10A
		4. Blue				
		5. Orange				
		6. Green				
		7. White-Black				

CHANGE-OUT SERIES A "SO" MALE PLUGS WITH ZINC DIECAST COUPLING NUT





POLES	FACE VIEW MALE	COLOR CODE	RATING	AWG	CABLE LENGTH	PART NUMBER
5		1. Red	300V, 6A	18	6'	X8872-6A
		2. White			12'	X8872-8A
		3. Black			18'	X8872-10A
6		1. Red	300V, 6A	18	6'	X8871-6A
		2. White			12'	X8871-8A
		3. Black			18'	X8871-10A
7		1. Red	300V, 5A	18	6'	X8870-6A
		2. White			12'	X8870-9A
		3. Black			18'	X8870-11A
		4. Blue				
		5. Orange				
		6. Green				
		7. White-Black				

Note: Special lengths available upon request — consult factory.

CHANGE-OUT SERIES A "SO" FEMALE PLUGS WITH NYLON COUPLING NUT

POLES	FACE VIEW FEMALE	COLOR CODE	RATING	AWG	CABLE LENGTH	PART NUMBER
5		1. Red	300V, 6A	18	6'	X8872-15A
		2. White			12'	X8872-17A
		3. Black			18'	X8872-19A
		4. Orange				
		5. Green				
6		1. Red	300V, 6A	18	6'	X8871-21A
		2. White			12'	X8871-23A
		3. Black			18'	X8871-25A
		4. Blue				
		5. Orange				
		6. Green				
7		1. Red	300V, 5A	18	6'	X8870-16A
		2. White			12'	X8870-18A
		3. Black			18'	X8870-20A
		4. Blue				
		5. Orange				
		6. Green				
		7. White-Black				
9		1. Green	110V, 3A	18	6'	X8980-7
		2. Red				
		3. White				
		4. Black				
		5. Red-Black				
		6. White-Black				
		7. Blue				
		8. Orange				
		9. Green-Black				

CHANGE-OUT SERIES A "SO" MALE PLUGS WITH NYLON COUPLING NUT

POLES	FACE VIEW MALE	COLOR CODE	RATING	AWG	CABLE LENGTH	PART NUMBER
5		1. Red	300V, 6A	18	6'	X8872-16A
		2. White			12'	X8872-18A
		3. Black			18'	X8872-20A
		4. Orange				
		5. Green				
6		1. Red	300V, 6A	18	6'	X8871-22A
		2. White			12'	X8871-24A
		3. Black			18'	X8871-26A
		4. Blue				
		5. Orange				
		6. Green				
7		1. Red	300V, 5A	18	6'	X8870-17A
		2. White			12'	X8870-19A
		3. Black			18'	X8870-21A
		4. Blue				
		5. Orange				
		6. Green				
		7. White-Black				
9		1. Green	110V, 3A	18	6'	X8980-10
		2. Red				
		3. White				
		4. Black				
		5. Red-Black				
		6. White-Black				
		7. Blue				
		8. Orange				
		9. Green-Black				

Note: Special lengths available upon request — consult factory.

CHANGE-OUT SERIES B "SO" FEMALE PLUGS WITH MACHINED ALUMINUM COUPLING NUT

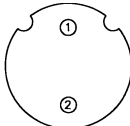
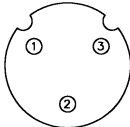
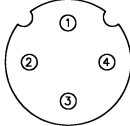
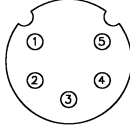
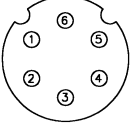
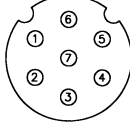
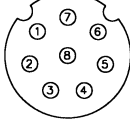
POLES	FACE VIEW FEMALE	COLOR CODE	RATING	AWG	CABLE LENGTH	PART NUMBER
2		1. White 2. Black	600V, 25A	10	6' 12' 18'	X8881-5 X8881-7 X8881-9
3		1. Black 2. White 3. Green	600V, 25A	10	6' 12' 18'	X8880-5 X8880-7 X8880-9
4		1. Red 2. White 3. Black 4. Green	600V, 20A	10	6' 12' 18'	X8879-5 X8879-7 X8879-9
5		1. Red 2. White 3. Black 4. Orange 5. Green	600V, 20A	10	6' 12' 18'	X8878-5 X8878-7 X8878-9
6		1. Red 2. White 3. Black 4. Blue 5. Orange 6. Green	600V, 20A	10	6' 12' 18'	X8877-7 X8877-9 X8877-11
7		1. Red 2. White 3. Black 4. Blue 5. Orange 6. Green 7. White-Black	600V, 18A	10	6' 12' 18'	X8876-7 X8876-9 X8876-11
8		1. Red 2. White 3. Black 4. White-Black 5. Blue 6. Orange 7. Green 8. Red-Black	600V, 11A	14	6' 12' 18'	X8916-5 X8916-6 X8916-7

Note: Special lengths available upon request — consult factory.

CHANGE-OUT SERIES B "SO" MALE PLUGS WITH DIECAST ALUMINUM COUPLING NUT

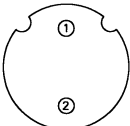
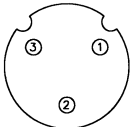
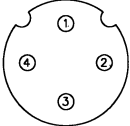
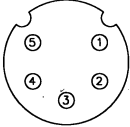
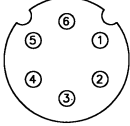
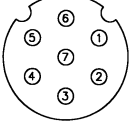
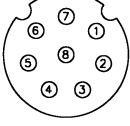
POLES	FACE VIEW MALE	COLOR CODE	RATING	AWG	CABLE LENGTH	PART NUMBER
2		1. White 2. Black	600V, 25A	10	6' 12' 18'	X8881-6B X8881-8B X8881-10B
3		1. Black 2. White 3. Green	600V, 25A	10	6' 12' 18"	X8880-6B X8880-8B X8880-10B
4		1. Red 2. White 3. Black 4. Green	600V, 20A	10	6' 12' 18'	X8879-6B X8879-8B X8879-10B
5		1. Red 2. White 3. Black 4. Orange 5. Green	600V, 20A	10	6' 12' 18'	X8878-6B X8878-8B X8878-10B
6		1. Red 2. White 3. Black 4. Blue 5. Orange 6. Green	600V, 20A	10	6' 12' 18'	X8877-8B X8877-10B X8877-12B
7		1. Red 2. White 3. Black 4. Blue 5. Orange 6. Green 7. White-Black	600V, 18A	10	6' 12' 18'	X8876-8B X8876-10B X8876-12B
8		1. Red 2. White 3. Black 4. White-Black 5. Blue 6. Orange 7. Green 8. Red-Black	600V, 11A	14	6' 12' 18'	X8916-8B X8916-9B X8916-10B

Note: Special lengths available upon request — consult factory.



SPECIFICATIONS CHANGE-OUT RECEPTACLES

Series A

- 2-9 Pole Configurations
- 2-4 Pole; #14 AWG, 12 AWG, 10 AWG
- 5-9 Pole; #18 AWG
- Lexan™ or Zinc Diecast Hardware

Series B

- 2-8 Pole Configurations
- 2-7 Pole; #10 AWG
- 8 Pole; #14 AWG
- Anodized Aluminum Hardware



TECHNICAL DATA

Agency Approvals

UL Recognition:

CSA Recognition:

File #E169897

File #LR13963

Electrical Data

Current Rating:

Voltage Rating:

Dielectric Withstand Voltage:

See chart with part number detail

See chart with part number detail

2200 VAC

Environmental Data

Protection:

Temperature Range:

NEMA 1, 3, 4, 6P and 13; IEC IP 68

-20°C to +105°C

Material Data

Body:

Pigtail Leads:

Contacts:

Receptacle Shell:

Series A: Black flame resistant PVC; Series B: Neoprene

Color coded type MTW or AWM style 1015/1230

Machined Brass, copper

Series A: Zamak or Lexan™

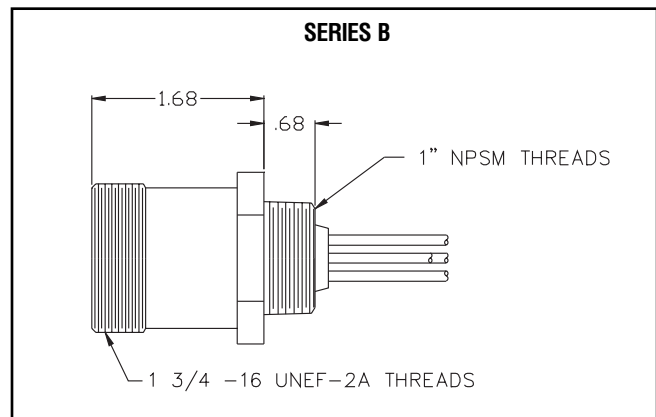
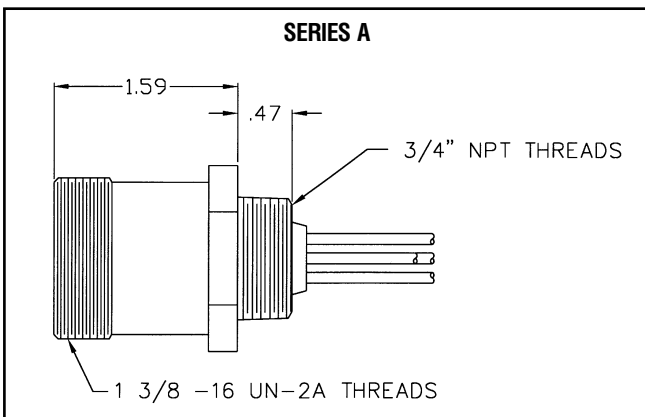

Series B: Machined Aluminum

DIMENSIONS





Lexan is a registered trademark of GE Plastics.



CHANGE-OUT SERIES A FEMALE RECEPTACLES WITH ZINC DIECAST RECEPTACLE SHELL

POLES	FACE VIEW FEMALE	COLOR CODE	RATING	AWG	1/C PIGTAIL	NPT PIPE THREAD	PART NUMBER
2		1. Black 2. White	600V, 18A	14	12"	1/2" 3/4"	X8651-10P X8651-11P
3		1. Black 2. White 3. Green	600V, 18A	14	12"	1/2" 3/4"	X8652-14P X8652-15P
4		1. Black 2. Green 3. Red 4. White	600V, 15A	14	12"	1/2" 3/4"	X8653-15P X8653-16P

CHANGE-OUT SERIES A MALE RECEPTACLES WITH ZINC DIECAST RECEPTACLE SHELL



POLES	FACE VIEW MALE	COLOR CODE	RATING	AWG	1/C PIGTAIL	NPT PIPE THREAD	PART NUMBER
2		1. Black 2. White	600V, 18A	14	12"	1/2" 3/4"	X8651-8P X8651-9P
3		1. Black 2. White 3. Green	600V, 18A	14	12"	1/2" 3/4"	X8652-12P X8652-13P
4		1. Black 2. Green 3. Red 4. White	600V, 15A	14	12"	1/2" 3/4"	X8653-13P X8653-14P

CHANGE-OUT SERIES A FEMALE RECEPTACLES WITH LEXAN RECEPTACLE SHELL



POLES	FACE VIEW FEMALE	COLOR CODE	RATING	AWG	1/C PIGTAIL	NPT PIPE THREAD	PART NUMBER
2		1. Black 2. White	600V, 18A	14	12"	1/2" 3/4"	X8651-76P X8651-84P
3		1. Black 2. White 3. Green	600V, 18A	14	12"	1/2" 3/4"	X8652-90P X8652-98P
4		1. Black 2. Green 3. Red 4. White	600V, 15A	14	12"	1/2" 3/4"	X8653-90P X8653-98P

Note: Special lead lengths available upon request — consult factory.



CHANGE-OUT SERIES A MALE RECEPTACLES WITH LEXAN RECEPTACLE SHELL

POLES	FACE VIEW MALE	COLOR CODE	RATING	AWG	1/C PIGTAIL	NPT PIPE THREAD	PART NUMBER
2		1. Black 2. White	600V, 18A	14	12"	1/2" 3/4"	X8651-77P X8651-85P
3		1. Black 2. White 3. Green	600V, 18A	14	12"	1/2" 3/4"	X8652-91P X8652-99P
4		1. Black 2. Green 3. Red 4. White	600V, 15A	14	12"	1/2" 3/4"	X8653-91P X8653-99P

CHANGE-OUT SERIES A FEMALE RECEPTACLES WITH ZINC DIECAST RECEPTACLE SHELL



POLES	FACE VIEW FEMALE	COLOR CODE	RATING	AWG	1/C PIGTAIL	NPT PIPE THREAD	PART NUMBER
2		1. Black 2. White	600V, 25A	12	12"	1/2" 3/4"	X8651-654P X8651-655P
3		1. Black 2. White 3. Green	600V, 25A	12	12"	1/2" 3/4"	X8652-654P X8652-686P
4		1. Black 2. Green 3. Red 4. White	600V, 20A	12	12"	1/2" 3/4"	X8653-654P X8653-655P

CHANGE-OUT SERIES A MALE RECEPTACLES WITH ZINC DIECAST RECEPTACLE SHELL



POLES	FACE VIEW MALE	COLOR CODE	RATING	AWG	1/C PIGTAIL	NPT THREAD	PART NUMBER
2		1. Black 2. White	600V, 25A	12	12"	1/2" 3/4"	X8651-648P X8651-649P
3		1. Black 2. White 3. Green	600V, 25A	12	12"	1/2" 3/4"	X8652-255P X8652-649P
4		1. Black 2. Green 3. Red 4. White	600V, 20A	12	12"	1/2" 3/4"	X8653-18P X8653-17P

Note: Special lead lengths available upon request — consult factory.



CHANGE-OUT SERIES A FEMALE RECEPTACLES WITH LEXAN RECEPTACLE SHELL

POLES	FACE VIEW FEMALE	COLOR CODE	RATING	AWG	1/C PIGTAIL	NPT PIPE THREAD	PART NUMBER
2		1. Black 2. White	600V, 25A	12	12"	1/2" 3/4"	X8651-1654P X8651-1655P
3		1. Black 2. White 3. Green	600V, 25A	12	12"	1/2" 3/4"	X8652-221P X8652-262P
4		1. Black 2. Green 3. Red 4. White	600V, 20A	12	12"	1/2" 3/4"	X8653-1634P X8653-383P

CHANGE-OUT SERIES A MALE RECEPTACLES WITH LEXAN RECEPTACLE SHELL



POLES	FACE VIEW MALE	COLOR CODE	RATING	AWG	1/C PIGTAIL	NPT PIPE THREAD	PART NUMBER
2		1. Black 2. White	600V, 25A	12	12"	1/2" 3/4"	X8651-1648P X8651-1649P
3		1. Black 2. White 3. Green	600V, 25A	12	12"	1/2" 3/4"	X8652-219P X8652-1649P
4		1. Black 2. Green 3. Red 4. White	600V, 20A	12	12"	1/2" 3/4"	X8653-253P X8653-1649P

CHANGE-OUT SERIES A FEMALE RECEPTACLES WITH ZINC DIECAST RECEPTACLE SHELL



POLES	FACE VIEW FEMALE	COLOR CODE	RATING	AWG	1/C PIGTAIL	NPT PIPE THREAD	PART NUMBER
2		1. Black 2. White	600V, 30A	10	12"	1/2" 3/4"	X8651-656P X8651-657P
3		1. Black 2. White 3. Green	600V, 30A	10	12"	1/2" 3/4"	X8652-656P X8652-657P
4		1. Black 2. Green 3. Red 4. White	600V, 25A	10	12"	1/2" 3/4"	X8653-656P X8653-657P

Note: Special lead lengths available upon request — consult factory.



CHANGE-OUT SERIES A MALE RECEPTACLES WITH ZINC DIECAST RECEPTACLE SHELL

POLES	FACE VIEW MALE	COLOR CODE	RATING	AWG	1/C PIGTAIL	NPT PIPE THREAD	PART NUMBER
2		1. Black 2. White	600V, 30A	10	12"	1/2" 3/4"	X8651-650P X8651-651P
3		1. Black 2. White 3. Green	600V, 30A	10	12"	1/2" 3/4"	X8652-650P X8652-651P
4		1. Black 2. Green 3. Red 4. White	600V, 25A	10	12"	1/2" 3/4"	X8653-650P X8653-651P

CHANGE-OUT SERIES A FEMALE RECEPTACLES WITH LEXAN RECEPTACLE SHELL



POLES	FACE VIEW FEMALE	COLOR CODE	RATING	AWG	1/C PIGTAIL	NPT PIPE THREAD	PART NUMBER
2		1. Black 2. White	600V, 30A	10	12"	1/2" 3/4"	X8651-1656P X8651-1657P
3		1. Black 2. White 3. Green	600V, 30A	10	12"	1/2" 3/4"	X8652-1656P X8652-1657P
4		1. Black 2. Green 3. Red 4. White	600V, 25A	10	12"	1/2" 3/4"	X8653-1656P X8653-384P

CHANGE-OUT SERIES A MALE RECEPTACLES WITH LEXAN RECEPTACLE SHELL



POLES	FACE VIEW MALE	COLOR CODE	RATING	AWG	1/C PIGTAIL	NPT PIPE THREAD	PART NUMBER
2		1. Black 2. White	600V, 30A	10	12"	1/2" 3/4"	X8651-1650P X8651-1651P
3		1. Black 2. White 3. Green	600V, 30A	10	12"	1/2" 3/4"	X8652-1650P X8652-1651P
4		1. Black 2. Green 3. Red 4. White	600V, 25A	10	12"	1/2" 3/4"	X8653-1650P X8653-1651P

Note: Special lead lengths available upon request — consult factory.

CHANGE-OUT SERIES A FEMALE RECEPTACLES WITH ZINC DIECAST RECEPTACLE SHELL





POLES	FACE VIEW FEMALE	COLOR CODE	RATING	AWG	1/C PIGTAIL	NPT PIPE THREAD	PART NUMBER
5		1. Red 2. White 3. Black 4. Orange 5. Green	300V, 6A	18	12"	1/2" 3/4"	X8872-1B X8872-11B
6		1. Red 2. White 3. Black 4. Blue 5. Orange 6. Green	300V, 6A	18	12"	1/2" 3/4"	X8871-1B X8871-11B
7		1. Red 2. White 3. Black 4. Blue 5. Orange 6. Green 7. White-Black	300V, 5A	18	12"	1/2" 3/4"	X8870-12B X8870-2B

CHANGE-OUT SERIES A MALE RECEPTACLES WITH ZINC DIECAST RECEPTACLE SHELL





POLES	FACE VIEW MALE	COLOR CODE	RATING	AWG	1/C PIGTAIL	NPT PIPE THREAD	PART NUMBER
5		1. Red 2. White 3. Black 4. Orange 5. Green	300V, 6A	18	12"	1/2" 3/4"	X8872-3B X8872-12B
6		1. Red 2. White 3. Black 4. Blue 5. Orange 6. Green	300V, 6A	18	12"	1/2" 3/4"	X8871-3B X8871-12B
7		1. Red 2. White 3. Black 4. Blue 5. Orange 6. Green 7. White-Black	300V, 5A	18	12"	1/2" 3/4"	X8870-13B X8870-4B

Note: Special lead lengths available upon request — consult factory.

CHANGE-OUT SERIES A FEMALE RECEPTACLES WITH LEXAN RECEPTACLE SHELL

POLES	FACE VIEW FEMALE	COLOR CODE	RATING	AWG	1/C PIGTAIL	NPT PIPE THREAD	PART NUMBER
5		1. Red 2. White 3. Black 4. Orange 5. Green	300V, 6A	18	12"	1/2" 3/4"	X8872-13B X8872-21B
6		1. Red 2. White 3. Black 4. Blue 5. Orange 6. Green	300V, 6A	18	12"	1/2" 3/4"	X8871-19B X8871-27B
7		1. Red 2. White 3. Black 4. Blue 5. Orange 6. Green 7. White-Black	300V, 5A	18	12"	1/2" 3/4"	X8870-22B X8870-14B
9		1. Green 2. Red 3. White 4. Black 5. Red-Black 6. White-Black 7. Blue 8. Orange 9. Green-Black	110V, 3A	18	12"	3/4"	X8980-3B

CHANGE-OUT SERIES A MALE RECEPTACLES WITH LEXAN RECEPTACLE SHELL

POLES	FACE VIEW MALE	COLOR CODE	RATING	AWG	1/C PIGTAIL	NPT PIPE THREAD	PART NUMBER
5		1. Red 2. White 3. Black 4. Orange 5. Green	300V, 30A	6	12"	1/2" 3/4"	X8872-14B X8872-22B
6		1. Red 2. White 3. Black 4. Blue 5. Orange 6. Green	300V, 30A	6	12"	1/2" 3/4"	X8871-20B X8871-28B
7		1. Red 2. White 3. Black 4. Blue 5. Orange 6. Green 7. White-Black	300V, 25A	5	12"	1/2" 3/4"	X8870-23B X8870-15B
9		1. Green 2. Red 3. White 4. Black 5. Red-Black 6. White-Black 7. Blue 8. Orange 9. Green-Black	110V, 25A	3	12"	3/4"	X8980-5B

Note: Special lead lengths available upon request — consult factory.

CHANGE-OUT SERIES B FEMALE RECEPTACLES WITH MACHINED ALUMINUM RECEPTACLE SHELL

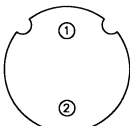
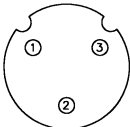
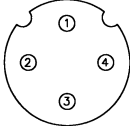
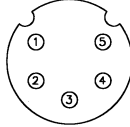
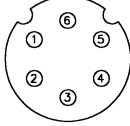
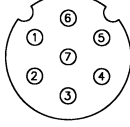
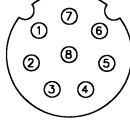
POLES	FACE VIEW FEMALE	COLOR CODE	RATING	AWG	1/C PIGTAIL	NPT PIPE THREAD	PART NUMBER
2		1. White 2. Black	600V, 25A	10	12"	1"	X8881-1
3		1. Black 2. White 3. Green	600V, 25A	10	12"	1"	X8880-1
4		1. Red 2. White 3. Black 4. Green	600V, 20A	10	12"	1"	X8879-1
5		1. Red 2. White 3. Black 4. Orange 5. Green	600V, 20A	10	12"	1"	X8878-1
6		1. Red 2. White 3. Black 4. Blue 5. Orange 6. Green	600V, 20A	10	12"	1"	X8877-1
7		1. Red 2. White 3. Black 4. Blue 5. Orange 6. Green 7. White-Black	600V, 18A	10	12"	1"	X8876-1
8		1. Red 2. White 3. Black 4. White-Black 5. Blue 6. Orange 7. Green 8. Red-Black	600V, 11A	14	12"	1"	X8916-1

Note: Special lead lengths available upon request — consult factory.

CHANGE-OUT SERIES B MALE RECEPTACLES WITH MACHINED ALUMINUM RECEPTACLE SHELL

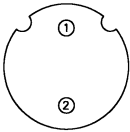
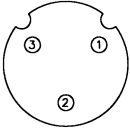
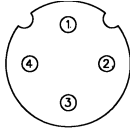
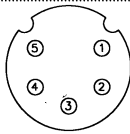
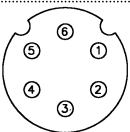
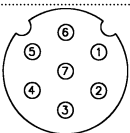
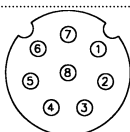
POLES	FACE VIEW MALE	COLOR CODE	RATING	AWG	1/C PIGTAIL	NPT PIPE THREAD	PART NUMBER
2		1. White 2. Black	600V, 25A	10	12"	1"	X8881-3B
3		1. Black 2. White 3. Green	600V, 25A	10	12"	1"	X8880-3B
4		1. Red 2. White 3. Black 4. Green	600V, 20A	10	12"	1"	X8879-3B
5		1. Red 2. White 3. Black 4. Orange 5. Green	600V, 20A	10	12"	1"	X8878-3B
6		1. Red 2. White 3. Black 4. Blue 5. Orange 6. Green	600V, 20A	10	12"	1"	X8877-3B
7		1. Red 2. White 3. Black 4. Blue 5. Orange 6. Green 7. White-Black	600V, 18A	10	12"	1"	X8876-3B
8		1. Red 2. White 3. Black 4. White-Black 5. Blue 6. Orange 7. Green 8. Red-Black	600V, 11A	14	12"	1"	X8916-3B

Note: Special lead lengths available upon request — consult factory.