



LS 96

Throughbeam photoelectric sensors



39m
65m

10 - 30 V
DC



- Throughbeam photoelectric sensors with high performance reserve in visible red light or infrared light
- Robust metal housing with glass cover or plastic housing, protection class IP 67 for industrial application
- Complementary outputs for standard applications and a wide range of input and output variants for optimum adaptation to the application
- Multiple options with warning output, activation input, switching delays and optics heating for use at low temperatures

Dimensioned drawing

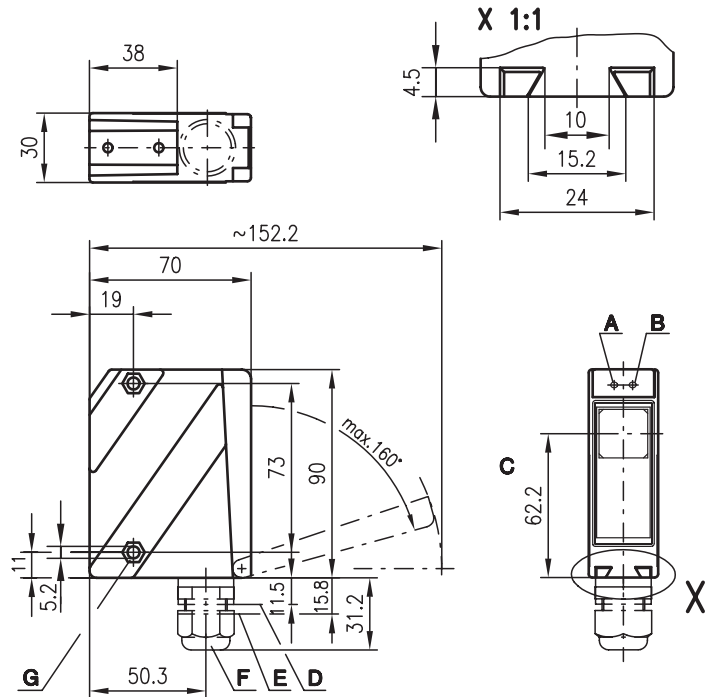

- A Indicator diode green
- B Indicator diode yellow
- C Optical axis
- D Device plug M12x1
- E Device plug M18x1
- F Screwed cable gland M16x1.5 for Ø 5 ... 10mm
- G Countersinking for SK nut M5, 4.2 deep
- H Connection terminals
- I Cable entry
- K Sensitivity adjustment

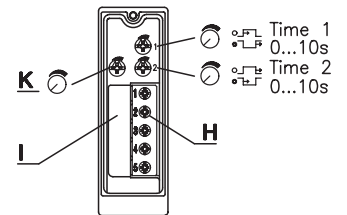

Electrical connection

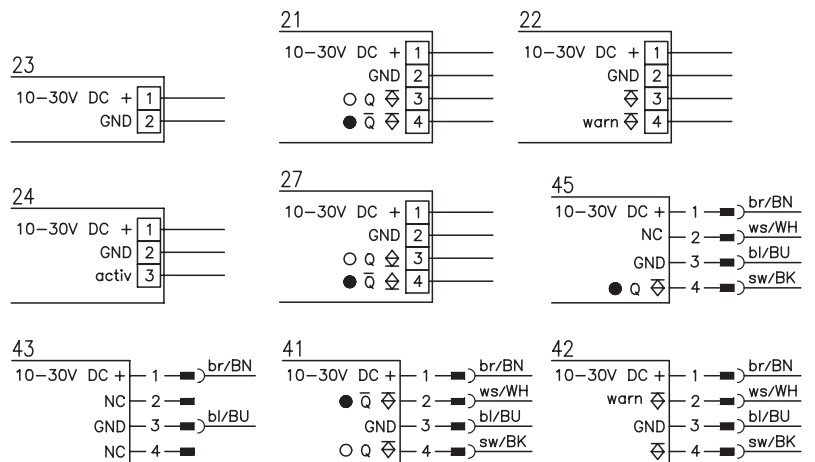

Accessories:

(available separately)

- Mounting systems (BT 96, BT 96.1, UMS 96, BT 450.1-96)
- M12 connectors (KD ...)
- Ready-made cables (K-D ...)
- Alignment aid ARH 96

We reserve the right to make changes • 96_a11e.fm

Specifications

Optical data

Typ. operating range limit ¹⁾
 Operating range ²⁾
 Light source
 Wavelength

Infrared light

0 ... 65m
 0 ... 50m
 LED (modulated light)
 880nm

Red light

0 ... 39m
 0 ... 30m
 LED (modulated light)
 660nm

Timing

Switching frequency 500Hz
 Response time 1ms
 Delay before start-up ≤ 200ms

Electrical data

Operating voltage U_B 10 ... 30VDC (incl. residual ripple)
 Residual ripple ≤ 15% of U_B
 Bias current ≤ 50mA, ≤ 130mA with optional optics heating
 Switching output NPN or PNP transistor
 Function characteristics light/dark switching
 Signal voltage high/low ≥ ($U_B - 2V$) / ≤ 2V (PNP)
 Output current max. 100mA
 Sensitivity adjustable

Indicators

LED green ready
 LED yellow light path free
 LED yellow flashing light path free, no performance reserve

Mechanical data

Housing polycarbonate
 Optics cover plastic
 Weight 150g
 Connection type terminals or M12 connector

Environmental data

Ambient temp. (operation/storage) -20°C ... +60°C / -40°C ... +70°C
 Protective circuit ³⁾ 1, 2, 3
 VDE safety class ⁴⁾ II, all-insulated
 Protection class IP 67
 LED class 1 (acc. to EN 60825-1)
 Standards applied IEC 60947-5-2

Options

Activation input activ ≤ 2V / ≥ 8V ⁵⁾
 Transmitter active/not active ≤ 0.5ms
 Activation/disable delay 47KΩ ± 10%
 Input resistance PNP transistor, 100mA, counting principle
Warning output autoControl warn for temperature changes, prevents fogging
Optics heating to -35°C
Low temperature 0 ... 10s (separately adjustable)
Switching delay (slow oper./release)

- 1) Typ. operating range limit: max. attainable range without performance reserve
- 2) Operating range: recommended range with performance reserve
- 3) 1=transient protection, 2=polarity reversal protection, 3=short-circuit protection for all outputs
- 4) Rating voltage 250VAC
- 5) Active low

Order guide

Selection table		Order code →							
Equipment ↓		LS 96K/P-1010-4 Part No. 500 25254 (Tr) Part No. 500 25258 (Re)	LS 96K/P-1030-2 Part No. 500 25255 (Tr) Part No. 500 25239 (Re)	LS 96K/P-1030-4 Part No. 500 25254 (Tr) Part No. 500 80483 (Re)	LS 96K/P-1140-2 Part No. 500 80657 (Tr) Part No. 500 31295 (Re)	LS 96K/P-1015-4 Part No. 500 25254 (Tr) Part No. 501 03004 (Re)	LS 96K/P-1010-1-4 Part No. 500 25254 (Tr) Part No. 501 03218 (Re)		
Housing	metal								
	plastic	●	●	●	●	●	●		
Light source	red light (30m)				●				
	infrared light (50m)	●	●	●		●	●		
Connection	terminals		●		●				
	M12 connector	●		●		●	●		
Features	switching delay		●	●					
	warning output								
	activation input				● 5)				
	PIN 2 = NC *					●	●		
	PIN 4 = dark switching					●			
	PIN 4 = light/dark reversible							●	

Tables

Red light

0	30	39
---	----	----

Infrared light

0	50	65
---	----	----

□ Operating range [m]
 ■ Typ. operating range limit [m]

Diagrams

Red light

Typ. response behaviour

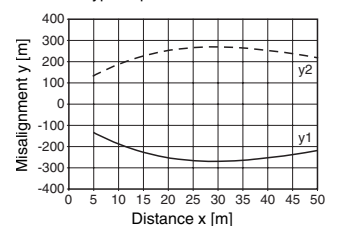

Infrared light

Typ. response behaviour

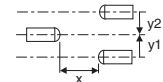
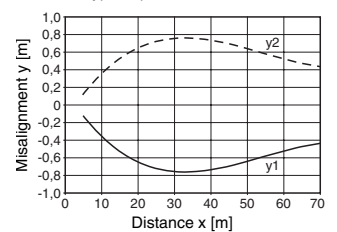

Remarks

- The throughbeam photoelectric sensor is also available with integrated AS-i chip for direct connection to the AS-i system.
- *For direct connection to AS-i I/O coupling modules (LS 96K/P-1015-4 and LS 96K/P-1010.1-4)