



LSIS 472i

Smart camera for compartment fine positioning



© 2015

Leuze electronic GmbH + Co. KG

In der Braike 1

D-73277 Owen / Germany

Phone: +49 7021 573-0

Fax: +49 7021 573-199

<http://www.leuze.com>

1	About this document.	5
1.1	Used symbols and signal words	5
2	Safety	6
2.1	Intended use	6
2.2	Foreseeable misuse	6
2.3	Competent persons	6
2.4	Exemption of liability	7
3	Device description	8
3.1	Device overview.	8
3.1.1	General information	8
3.1.2	Performance characteristics	9
3.1.3	Accessories	10
3.1.4	Device model with heating.	10
3.2	Connection technology	10
3.3	Indicators and operational controls	11
3.3.1	LED indicators	12
3.3.2	Control buttons	12
3.3.3	Display.	12
4	Functions	15
4.1	Functionality of the device	15
4.2	Check programs	15
4.3	Diagnostics – image transfer	16
4.4	Process sequence	16
5	Applications	18
6	Mounting.	19
6.1	Installation instructions	19
6.2	Mounting with BT 56 mounting device	19
6.3	Mounting with BT 59 mounting device	19
6.4	BPS mounting with M4 fastening screws.	20
7	Electrical connection	21
7.1	Overview	21
7.2	PWR (supply voltage and switching inputs IO1 ... IO4)	22
7.3	BUS OUT (RS 232 and switching outputs IO5 ... IO8)	23
7.4	SERVICE.	24
8	Commissioning	25
8.1	Commissioning the device.	25
8.2	Mechanically aligning the device via the display	25
8.3	Teaching-in the position.	27
8.4	Parameter enable	28
9	Extended configuration – Leuze electronic webConfig tool	29
9.1	Establishing an Ethernet connection	29
9.2	Start webConfig tool	30
9.3	Short description of the webConfig tool.	31
9.3.1	Operating modes	31

9.3.2	Configuration via the webConfig tool	31
9.3.3	Selecting the check program	32
9.3.4	Configure compartment fine positioning	32
9.3.5	Calibrating	33
9.3.6	Configuring image acquisition	35
9.3.7	Configuring the BLOB analysis	36
9.3.8	Configuring the measurement	37
9.3.9	Defining changeover of the check programs	38
9.3.10	Configuring the digital switching inputs/outputs	38
9.3.11	Assigning digital switching outputs the measurement values	39
9.3.12	Activating display of the target/actual deviation in the display	41
9.3.13	Configuring the FTP output	42
9.3.14	Configuring the Ethernet output	44
10	Troubleshooting	47
11	Care, maintenance and disposal	48
11.1	Cleaning	48
11.2	Servicing	48
11.3	Disposing	48
12	Service and support	49
12.1	What to do should servicing be required?	49
13	Technical data	50
13.1	General specifications	50
13.2	Dimensioned drawings	52
14	Ordering information and accessories	53
14.1	Type overview LSIS 472i	53
14.2	Cables-Accessories	53
14.3	Other accessories	54
15	EC Declaration of Conformity	55

1 About this document

1.1 Used symbols and signal words

Table 1.1: Warning symbols and signal words

	Symbol indicating dangers to persons
NOTICE	Signal word for property damage Indicates dangers that may result in property damage if the measures for danger avoidance are not followed.

Table 1.2: Other symbols



	Symbol for tips Text passages with this symbol provide you with further information.
	Symbols for action steps Text passages with this symbol instruct you to perform actions.

Table 1.3: Terms and abbreviations

BLOB	Binary Large Object Hole or reflector for positioning
EN	European standard
FE	Functional earth
FOV	Field of View of the smart camera
IO or I/O	Input/Output
MAC address	Media Access Control address; hardware address of a device in the network
PELV	Protective Extra-Low Voltage; protective extra-low voltage with reliable disconnection
HBS	High-bay storage device
ROI	Region of Interest; capture range of the smart camera
UL	Underwriters Laboratories

2 Safety

The smart camera of the LSIS 472i series was developed, manufactured and tested in accordance with the applicable safety standards. It corresponds to the state of the art. The LSIS 472i smart camera without device heating is "UL LISTED" according to American and Canadian safety standards, i.e., satisfies the requirements of Underwriters Laboratories Inc. (UL).

The variant with device heating is being prepared.

2.1 Intended use

The LSIS 472i smart camera for compartment fine positioning is designed for optical, contactless fine positioning of high-bay storage devices in conveyor and storage systems.

Positioning is performed using markings (hole or reflector) in the crossbeams.

NOTICE
Comply with conditions and regulations!
↳ Observe the locally applicable legal regulations and the rules of the employer's liability insurance association.

2.2 Foreseeable misuse

Any use other than that defined under "Intended use" or which goes beyond that use is considered improper use.

In particular, use of the device is not permitted in the following cases:

- Rooms with explosive atmospheres
- Circuits relevant to safety
- operation for medical purposes

NOTICE
Do not modify or otherwise interfere with the device.
↳ Do not carry out modifications or otherwise interfere with the device.
The device must not be tampered with and must not be changed in any way.
The device must not be opened. There are no user-serviceable parts inside.
Repairs must only be performed by Leuze electronic GmbH + Co. KG.

2.3 Competent persons

Connection, mounting, commissioning and adjustment of the device must only be carried out by competent persons.

Prerequisites for competent persons:

- They have a suitable technical education.
- They are familiar with the rules and regulations for occupational safety and safety at work.
- They are familiar with the technical description of the device.
- They have been instructed by the responsible person on the mounting and operation of the device.

Certified electricians

Electrical work must be carried out by a certified electrician.

Due to their technical training, knowledge and experience as well as their familiarity with relevant standards and regulations, certified electricians are able to perform work on electrical systems and independently detect possible dangers.

In Germany, certified electricians must fulfill the requirements of accident-prevention regulations BGV A3 (e.g. electrician foreman). In other countries, there are respective regulations that must be observed.

2.4 Exemption of liability

Leuze electronic GmbH + Co. KG is not liable in the following cases:

- The device is not being used properly.
- Reasonably foreseeable misuse is not taken into account.
- Mounting and electrical connection are not properly performed.
- Changes (e.g., constructional) are made to the device.

3 Device description

3.1 Device overview

3.1.1 General information

The LSIS 472i smart camera facilitates fast and simple positioning of high-bay storage devices in conveyor and storage systems.

- Positioning is designed for a single- or double-deep pallet high-bay warehouse (*Rack Near, Rack Far*).
- The device detects circular holes or reflectors in crossbeams in the rack construction and determines the position deviation in the X- and Y-direction relative to the target position.
- The position deviation is output to the control via four digital outputs or via the interface.
- The device can be operated and configured by means of the integrated webConfig tool via the Ethernet service interface.

The device consists of the following components:

- Camera
- Display and control panel
- Infrared lighting unit
- Evaluation unit with the following interfaces:
 - Digital I/O
 - Ethernet
 - RS 232

The device can optionally be delivered with integrated heater.



- 1 Display and control panel
- 2 Camera and lighting unit
- 3 M4 mounting thread
- 4 Electrical connections
- 5 Fastening groove

Figure 3.1: Device construction

Markings

The smart camera detects the following markings:

- Hole: dark marking on light background
- Reflector: light marking on dark background

Which markings (hole or reflector) need to be present in the crossbeam of the rack is dependent on the working distance and the crossbeam:

- *Rack Near*: compartment fine positioning on hole or reflector
- *Rack Far*: compartment fine positioning on reflector

3.1.2 Performance characteristics

The most important performance characteristics of the smart camera:

- Positioning accuracy up to ± 2 mm
- Reading distance 250 mm to 1900 mm
- Integrated IR illumination (850 nm infrared LED)
- Integrated display with control panel for alignment and for fast teaching of the position marking (hole or reflector).
- Measurement value output:
 - 4 digital outputs
 - Ethernet

- Optionally via MA 2xxi modular connection unit
- Interfaces:
 - RS 232 and Ethernet TCP/IP
 - PROFINET, PROFIBUS, CANopen, DeviceNet and EtherCat via MA 2xxi modular connection unit
- Alignment via display and webConfig tool
- Diagnostics in Process mode through image transfer via FTP transfer
- Optional model with heating for use to -35 °C

3.1.3 Accessories

Special accessories are available for the smart camera. The accessories are optimally matched to the smart camera:

- Ready-made connection and interconnection cables for M12 connectors
- Mounting devices for precise mounting
- Reflectors for *Rack Near* and *Rack Far* compartment depths

3.1.4 Device model with heating

The device is optionally available as a model with integrated heating. In this case, heating is permanently installed ex works.

The heating consists of two parts:

- Optics glass heating
- Housing heater

Features of the integrated heating:

- Extends the application range to -35 °C
- Supply voltage: 24 VDC ± 20 %
- Required conductor cross-section for the power supply: At least 0.75 mm²
Thus, it is not possible to use ready-made cables.

3.2 Connection technology

The device is connected using variously coded M12 connectors.

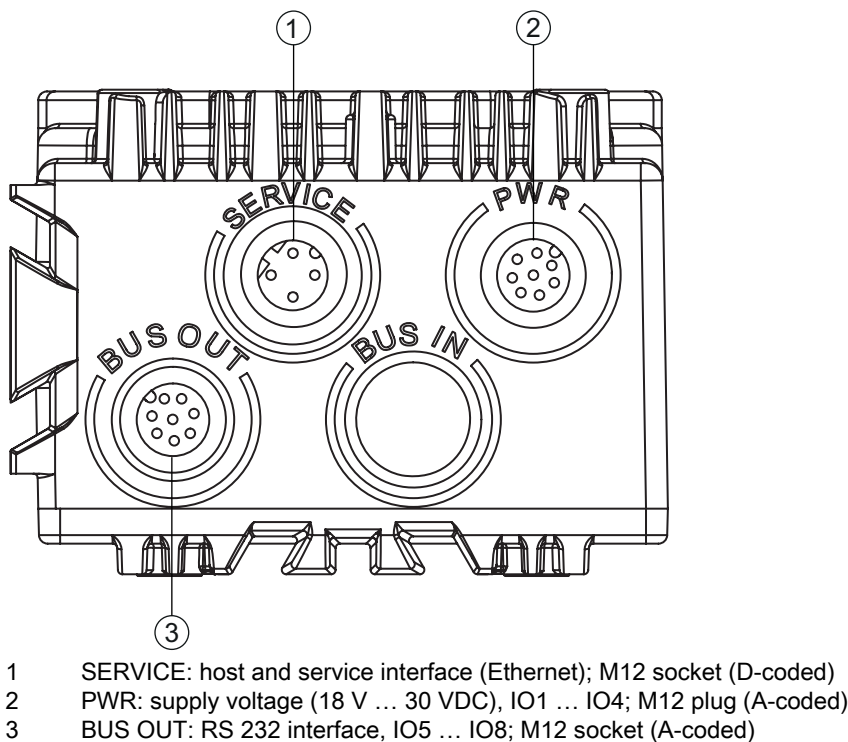

Figure 3.2: Electrical connections



Ready-made cables are available for all connections; see chapter 14.2 "Cables-Accessories".

NOTICE

Shielding connection

The shielding connection is done via the M12 connector housing

3.3 Indicators and operational controls

The device is equipped with the following indicators and operational controls:

- Two LED indicators
- Four control buttons
- Monochromatic display

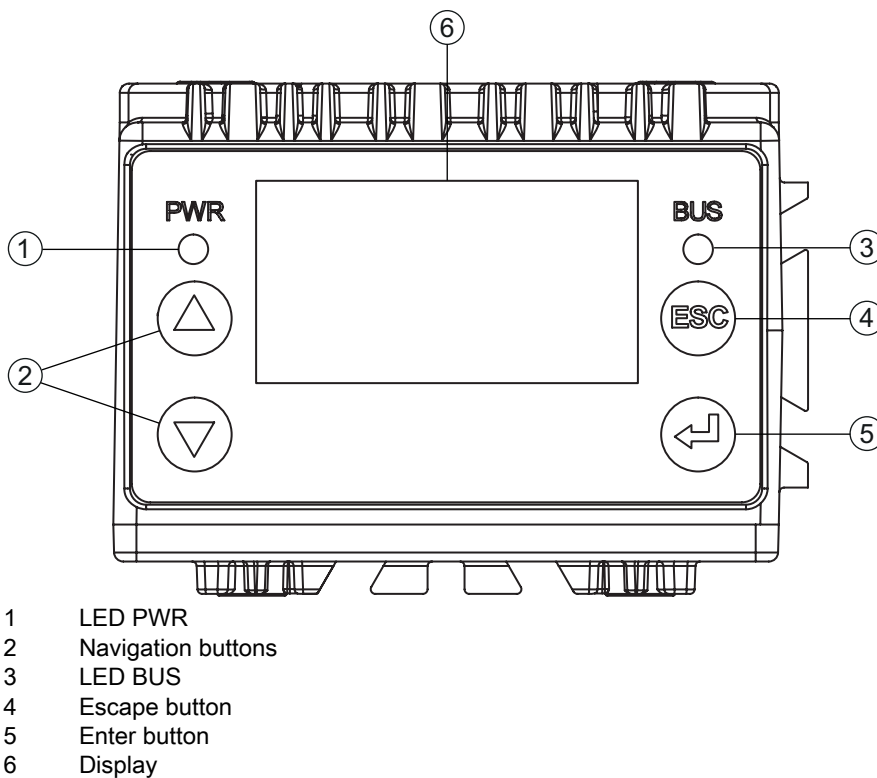

Figure 3.3: Indicators and operational controls





3.3.1 LED indicators

Table 3.1: Meaning of the LED indicators

LED	Color, state	Description
LED PWR	Off	Device is switched off <ul style="list-style-type: none"> • no supply voltage
	Green, flashing	Device is being initialized <ul style="list-style-type: none"> • Supply voltage connected • Self test running • Initialization running
	Green, continuous light	Process mode <ul style="list-style-type: none"> • Initialization finished • Self test successfully finished • Position display activated
	Orange, continuous light	Service mode <ul style="list-style-type: none"> • Alignment via display • Configuration via Ethernet service interface • Configuration via the webConfig tool
	Red, flashing	Warning set <ul style="list-style-type: none"> • Inspection mode • Temporary operating fault
	Red, continuous light	Device error
LED BUS	Off	No supply voltage
	Green, flashing	Bus initialization, a pulse
	Green, continuous light	Device ready for communication
	Red, flashing	Communication error

3.3.2 Control buttons

The display is controlled via the control buttons. You can call up various pieces of information via the control buttons (e.g., the IP address of the device) or make adjustments in the application; e.g., teach-in.

-  - Scrolling through functions (upwards)
-  - Scrolling through functions (downwards)
-  - Escape button: exit the menu item, move up one menu level
-  - Enter button: select function, confirm/enter value



Navigating within the menus

Use the navigation buttons   to move through the menu.

Activate the desired selection with the enter button .

Press the escape button  to move up one menu level.

Selecting options

Set the desired option with the navigation buttons   and the enter button .

3.3.3 Display

Display functions

The following functions can be displayed and activated in the display:

- Device information

- Device type
- *SW*: Software version
- *HW*: Hardware version
- *SN*: Serial number
- Status displays
 - Status display of the switching inputs/outputs
 - Display of warnings and errors
 - Status information for the device interfaces
 - Target/actual position deviation for X- and Y-coordinates in mm
- Statistics

Statistics data for the smart camera:

 - *Tested*
Number of check program runs since the last time the counter was reset
 - *OK*
Number of successful check program runs
 - *NOK*
Number of unsuccessful check program runs
- Position display of the marking (hole or reflector)

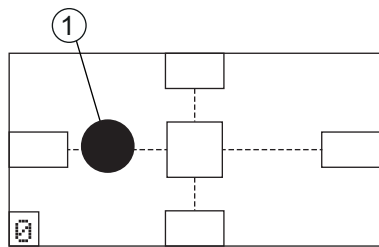

1 Actual position of the marking within the capture range

Figure 3.4: Position display

- Parameter
 - *Parameter handling*
Lock and enable parameter entry on the display
Define password for enabling parameter entry
Reset parameters to factory settings
 - *Display settings*
Rotate the display 180°
Only possible with enabled parameter entry
 - *Program selection*
Activation of the check program via the display for compartment fine positioning: *Rack Near* or *Rack Far*
 - *Ethernet*
Configuration of the host and service interface
- Language
Selection of the language used in the display:
German, English, Spanish, French, Italian
- Service
 - *Status messages*
Only for service purposes by Leuze electronic
 - *Commissioning*
Selection of the check program and position display for alignment; see chapter 8 "Commissioning"
Teaching-in of the position (teach); see chapter 8.3 "Teaching-in the position"



In Service mode, the device is decoupled from Process mode. Triggering via the switching inputs is not possible and the digital switching outputs are not set.

Display during device start-up

During device start-up, a start-up display first appears which is briefly followed by the display with the version information.

After the device starts up, the display shows the position display by default.

4 Functions

4.1 Functionality of the device

Compartment fine positioning is used for the detection of so-called hole positions (hole or reflector) that are set into crossbeams of the high rack.

- Two different hole positions can be detected, *Rack Near* and *Rack Far*.
A check program is stored on the device for each detection position.
The distance between the rack profiles and the lens cover of the device can be specified for each hole position.
- The control uses a signal that is constantly applied at digital switching inputs IO2 and IO3 to determine which check program is active; see chapter 4.4 "Process sequence".

4.2 Check programs

The *Rack Near* and *Rack Far* check programs detect the respective hole position. A BLOB tool and a measuring tool in the check program are used for this purpose.

- With activation, compartment fine positioning for the *Rack Near* or *Rack Far* check program is started or stopped via digital switching input IO1.

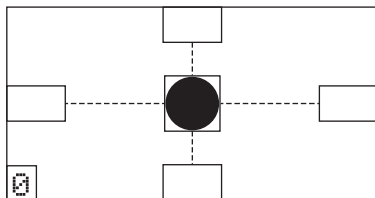

Figure 4.1: Display of the detected hole position

- Digital switching outputs IO5 ... IO8 signal whether the device is within the scan area for *Rack Near* or *Rack Far* in relation to the hole position. Whether or not compartment fine positioning is correct or whether the high-bay storage device is positioned too far to the left or right and/or too far up or down relative to the hole position is displayed.

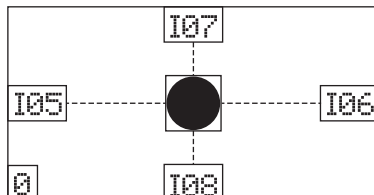

Figure 4.2: Switching outputs IO5 ... IO8 activated

Digital switching outputs IO5 ... IO8 are permanently on as long as the control performs compartment fine positioning via the device.

- To compensate for the difference in position between loading position and unloading position of the high-bay storage device, a shift of the coordinate origin is defined for the current check program by entering an offset value.

On delivery, two check programs are set up in the device for *Rack Near* and *Rack Far*. These check programs are optimized as follows:

- *Rack Near*
Distance: 450 mm
Hole diameter: 15 mm
- *Rack Far*
Distance: 1850 mm
Hole diameter: 15 mm

4.3 Diagnostics – image transfer

For diagnostics, the smart camera images can be stored (parallel to the check program procedure) in the ring buffer.

- Saving the images in the ring buffer is started (IO4=1) and ended (IO4=0) via digital switching input IO4.
- A maximum of 14 images are stored in the ring buffer, with the oldest images being overwritten once the buffer is full.
14 images in the ring buffer correspond to approx. 500 ms of positioning.

The images can be transferred to an FTP server via FTP for diagnostics:

- To transfer the images, an M12 Ethernet connection cable must be connected between the smart camera and a PC or laptop as FTP server.
Alternatively, the smart camera can be connected to a network in which the FTP server can be accessed.
- Data transmission via FTP:
 - The FTP access data must be entered in the webConfig tool.
 - Data transmission via FTP must be activated in the webConfig tool.
The images are not transferred from the ring buffer until after the trigger signal (IO1=0) has been reset.
 - Upon conclusion of diagnostics, data transmission via FTP must be deactivated in the webConfig tool.
The M12 Ethernet connection cable can be removed after completing diagnostics.
 - The FTP access data can be stored in the smart camera for later diagnostics.
 - Details on the settings in the webConfig tool: see chapter 9 "Extended configuration – Leuze electronic webConfig tool".

4.4 Process sequence

Prerequisite: The high-bay storage device knows the hole positions for *Rack Near* and *Rack Far*.

NOTICE

Incoming signals are ignored while changing the check programs!

↪ While the check programs are being changed internally, additional incoming signals are ignored, including the trigger signals.

The internal changeover of the check programs lasts up to 300 ms.

- Shortly before reaching the target position (capture range), a permanently applied signal at switching inputs IO2 and IO3 specifies the check program for the device.
Program 1: IO2=0 and IO3=0, corresponds to *Rack Near*
Program 2: IO2=0 and IO3=1, corresponds to *Rack Far*
- The control activates the test procedure, i.e., compartment fine positioning, by setting switching input IO1=1.
Tool evaluation, i.e., execution of the check program, is started beginning at this point in time. Digital switching outputs IO5 ... IO8 are output statically as long as the specified hole position is detected in the respective tool.
- At the end of check program execution, a check for the presence of the activation signal (IO1=1) is performed.
If the activation signal is still present, the check program is immediately executed again.
- If the activation signal (IO1) is reset while a check program is being executed (IO1=0), this check continues to run. Switching outputs IO5 ... IO8 are then set to 0.
- If switching output IO5 ... IO8=1 and the high-bay storage device has reached the target position, loading or unloading is started.
- Parallel to the test procedure, switching input IO4 can be used to start (IO4=1) or end (IO4=0) the saving of images in the ring buffer. The user can thereby separate the check program procedure from the image.

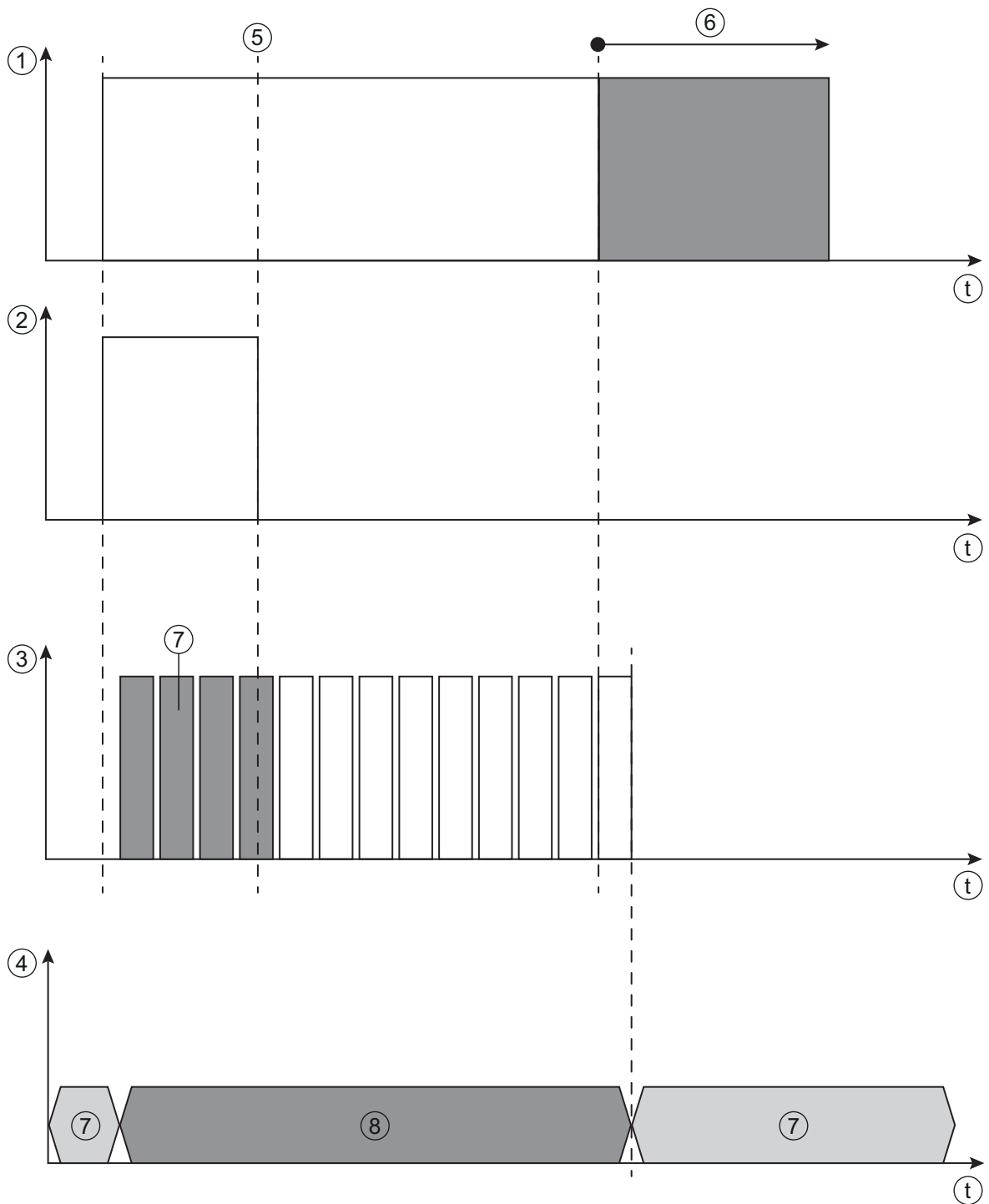

- 1 Activation: IO1
- 2 Image acquisition in ring buffer: IO4
- 3 Program runs
- 4 State IO5 ... IO8
- 5 IO5 ... IO8 stable
- 6 Image transfer via FTP
- 7(3) Images that are written in the ring buffer
- 7(4) IO5 ... IO8: output inactive (low)
- 8 IO5 ... IO8: output active (high), tool result

Figure 4.3: Process sequence

5 Applications

Following rough positioning, the LSIS 472i smart camera is used for the optical, contactless, compartment fine positioning of a high-bay storage device in X- and Y-direction. It is possible to use just one camera in single-deep and double-deep pallet high-bay warehouses.



Figure 5.1: Compartment fine positioning of a high-bay storage device in a double-deep pallet high-bay warehouse

6 Mounting

The device can be mounted in the following ways:

- Mounting using a mounting device on the fastening grooves on the rear of the device or on the narrow side of the device.
 - BT 56: Mounting on a rod
 - BT 59: Wall mounting
- Mounting via M4 mounting thread:
 - on the rear side of the device
 - on the front side of the device
 - on the narrow side of the device

6.1 Installation instructions

NOTICE

Observe during mounting!

- ↪ Make certain that the required environmental conditions (humidity, temperature) are maintained.
- ↪ Affix the markings for compartment fine positioning according to the working distance:
 - Rack Near:* hole or reflector
 - Rack Far:* reflector only
- ↪ Make certain that the area behind a hole is not obstructed.
 - With closed profiles, only reflectors may be used as markings.
 - There must not be a light source behind a hole.
- ↪ Avoid glossy, reflective surfaces behind the holes.
 - The surface surrounding a hole must reflect diffusely, i.e., no glossy surfaces.
- ↪ Avoid interfering contours in the camera's field of view, e.g., stamped numbers.
- ↪ Make certain that there is only one marking (hole or reflector) in the capture range of the smart camera.
 - Screw heads with identical diameter must not be located in the capture range of the smart camera.
- ↪ Make certain that the lens cover of the smart camera is oriented parallel to the marking (hole or reflector).
- ↪ Make certain that the marking (hole or reflector) is located as close to the middle of the capture range of the smart camera as possible.
- ↪ Make certain that the camera window is not soiled, e.g., by leaking fluids, abrasion from boxes or residues from packaging material.

6.2 Mounting with BT 56 mounting device

Mounting with a BT 56 mounting device is intended for rod mounting. For ordering information, see chapter 14.3.

- ↪ Mount the BT 56 on the rod with the clamp profile (system-side).
- ↪ Mount the device with its fastening grooves on the clamping jaws of the BT 56 with limit stop at end.
- ↪ Secure the device with the M6 screw terminal.
 - Maximum tightening torque for the M6 screw terminal: 8 Nm

6.3 Mounting with BT 59 mounting device

Mounting with a BT 59 mounting device is intended for wall mounting. For ordering information, see chapter 14.3.

- ↪ Mount the BT 59 mounting device on the system side with M8 fastening screws (included in delivery contents).
- ↪ Mount the device with its fastening grooves on the clamping jaws of the BT 59 with limit stop at end.
- ↪ Secure the device with the M6 screw terminal.

Maximum tightening torque for the M6 screw terminal: 8 Nm

6.4 BPS mounting with M4 fastening screws

↳ Mount the device on the system with M4 fastening screws (not included in delivery contents).

Max. tightening torque of the fastening screws: 2 Nm

Location and thread depth of the mounting thread: see figure 13.1

7 Electrical connection

7.1 Overview

The electrical connection of the device is performed using M12 connectors.

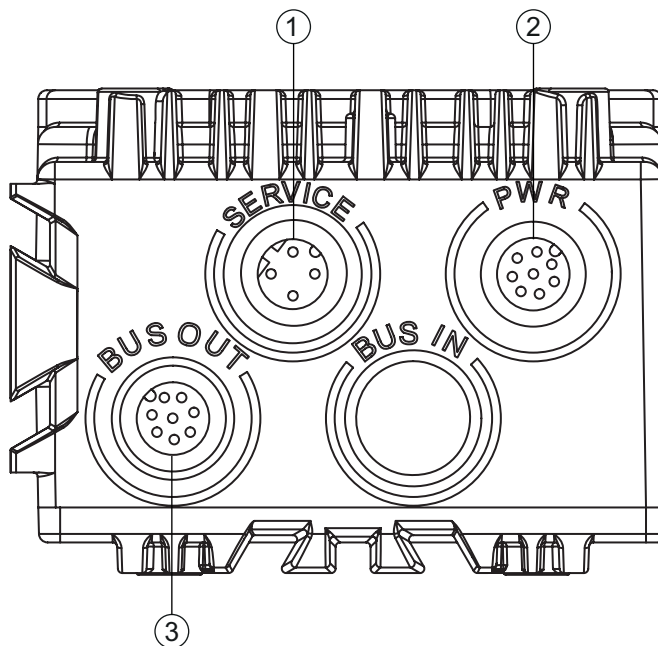

- 1 SERVICE: host and service interface (Ethernet); M12-socket (D-coded)
- 2 PWR: supply voltage (18 V ... 30 VDC), IO1 ... IO4; M12 plug (A-coded)
- 3 BUS OUT: RS 232 interface, IO5 ... IO8; M12 socket (A-coded)

Figure 7.1: Position and designation of the M12 connections



For all connections (connection cable, interconnection cable, etc.), use only the cables listed in the accessories (see chapter 14.2 "Cables-Accessories").

CAUTION

Safety Notices!

- ⚡ Before connecting the device please ensure that the supply voltage matches the value printed on the nameplate.
- ⚡ Only allow competent persons to perform the electrical connection.
- ⚡ The shielding connection is done via the M12 connector housing.
- ⚡ Ensure that the functional earth (FE) is connected correctly.
Fault-free operation is only guaranteed if the functional earth is connected properly.
All electrical disturbances (EMC couplings) are discharged via the functional earth connection.
- ⚡ If faults cannot be rectified, take the device out of operation. Protect the device from accidentally being started.

NOTICE

UL applications

- ⚡ For UL applications, use is only permitted in class 2 circuits in accordance with the NEC (National Electric Code).

NOTICE

Protective Extra-Low Voltage (PELV)

↪ The smart camera of the LSIS 4xxi series is designed in accordance with safety class III for supply by PELV (protective extra-low voltage with reliable disconnection).

NOTICE

Degree of protection IP 65 / IP 67

↪ Degree of protection IP 65 / IP 67 is only achieved with screwed-on connectors.

- ↪ Connect the supply voltage (18 V ... 30 VDC) to the PWR connection.
- ↪ Connect switching inputs IO1 ... IO4 to the PWR connection.
- ↪ Connect switching outputs IO5 ... IO8 to the BUS OUT connection.
- ↪ Connect your RS 232 process interface to the BUS OUT connection.
- ↪ Connect the Ethernet cable for configuration and diagnostics to the SERVICE connection.

7.2 PWR (supply voltage and switching inputs IO1 ... IO4)

8-pin M12 plug (A-coded)

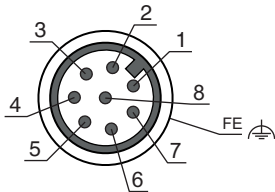

Figure 7.2: Pin assignment of the PWR connection

Table 7.1: PWR pin assignment

Pin	Designation	Assignment
1	VIN	Positive supply voltage +18 ... +30 VDC
2	IO1	Switching input 1 <ul style="list-style-type: none"> • Activation - program start • Function: reading gate start/stop
3	GND	Negative supply voltage 0 VDC
4	IO2	Switching input 2 <ul style="list-style-type: none"> • Program selection 1
5	IO3	Switching input 3 <ul style="list-style-type: none"> • Program selection 2
6	IO4	Switching input 4 <ul style="list-style-type: none"> • Error image memory active • Start: write images in ring buffer
7	NC	Not connected
8	FE	Functional earth
(Thread for M12 connector plug)	FE	Connection cable shield The shield of the connection cable is on the thread of the M12 connector plug. The thread of the M12 connector plug is part of the metallic housing. The housing is at the potential of the functional earth via pin 8.

Connection cables: see table 14.2

NOTICE
Maximum input current
↪ The maximum input current of the switching inputs is 8 mA.

7.3 BUS OUT (RS 232 and switching outputs IO5 ... IO8)

8-pin M12 socket (A-coded)

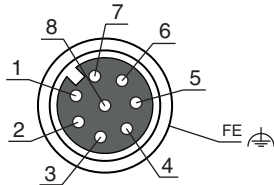

Figure 7.3: Pin assignment of the BUS OUT connection

Table 7.2: BUS OUT pin assignment

Pin	Designation	Assignment
1	IO5	Configurable switching output 1 Compartment fine positioning (-X)
2	IO6	Configurable switching output 2 Compartment fine positioning (+X)
3	GND	Negative supply voltage 0 VDC
4	IO7	Configurable switching output 3 Compartment fine positioning (+Y)
5	IO8	Configurable switching output 4 Compartment fine positioning (-Y)
6	Rx	Rx signal (RS 232)
7	Tx	Tx signal (RS 232)
8	FE	Functional earth
(Thread for M12 connector plug)	FE	Connection cable shield The shield of the connection cable is on the thread of the M12 connector plug. The thread of the M12 connector plug is part of the metallic housing. The housing is at the potential of the functional earth via pin 8.

Connection cables: see table 14.2

NOTICE
Maximum loading of the switching outputs
↪ Do not load the switching outputs with more than 60 mA at +18 ... +30 VDC. The switching outputs are protected against short-circuit, overcurrent, overvoltage, excess temperature and transients.

NOTICE
Maximum cable length 10 m
↪ Operation of the RS 232 interface is only permissible with shielded cables with maximum cable length of 10 m.

7.4 SERVICE

4-pin M12 socket (D-coded)

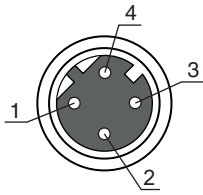

Figure 7.4: Pin assignment of the SERVICE connection

Table 7.3: SERVICE pin assignment

Pin	Designation	Assignment
1	TD+	Transmit Data +
2	RD+	Receive Data +
3	TD-	Transmit Data -
(Thread for M12 connector plug)	FE	Connection cable shield The shield of the connection cable is on the thread of the M12 connector plug. The thread of the M12 connector plug is part of the metallic housing. The housing is at the same potential as functional earth.

Connection cables: see table 14.2

Ethernet cable assignment

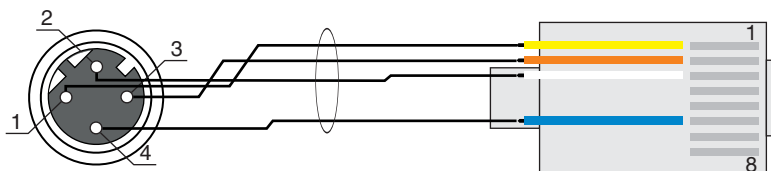

Figure 7.5: Cable assignments - SERVICE on RJ-45

Designed as shielded cable, max. length 100 m.

Pin (M12)	Designation	Pin/core color (RJ-45)
1	TD+	1/yellow
2	RD+	3/white
3	TD-	2/orange
4	RD-	6/blue

NOTICE

Self-configured cables for Ethernet connection!

- ↳ The depicted core colors apply only for interconnection cables from Leuze electronic.
The depicted core colors are not compliant with EIA/TIA 568A and EIA/TIA 568B.
- ↳ Ensure adequate shielding.
- ↳ The entire interconnection cable must be shielded and earthed.
- ↳ The RD+/RD- and TD+/TD- wires must be stranded in pairs.
- ↳ Use CAT 5 cable for the connection.

8 Commissioning

Basic operation of the device is via a multi-language display and control buttons or via the webConfig configuration tool.

For faster commissioning, the most important parameters for compartment fine positioning are set on a connected PC/laptop via a configuration dialog in the webConfig tool.

Commissioning includes the mechanical alignment of the smart camera and the teaching-in of the position via the display and control buttons as well as calibration, i.e., calibration of distance and marking size, via the webConfig tool.

8.1 Commissioning the device

↵ Electrically connect the smart camera and apply the supply voltage.

The smart camera starts up and the position display appears on the display.

↵ Connect the smart camera to a PC/laptop and start the webConfig tool; see chapter 9 "Extended configuration – Leuze electronic webConfig tool".

↵ Make the settings for your application with the webConfig tool; see chapter 9.3.4 "Configure compartment fine positioning".

Disconnect the smart camera from the PC/laptop and from the power source.

↵ Mount the smart camera in your application; see chapter 6 "Mounting".

Electrically connect the smart camera in your application; see chapter 7 "Electrical connection".

Connect the supply voltage.

↵ Mechanically align the smart camera with the marking via the display and control buttons; see chapter 8.2 "Mechanically aligning the device via the display".

NOTICE

Adjusting compartment fine positioning with the webConfig tool!

↵ To align via the display and the control buttons, the current configuration for compartment fine positioning must be set with the webConfig tool and be stored in the device; see chapter 9 "Extended configuration – Leuze electronic webConfig tool".

↵ Teach-in the position of the smart camera; see chapter 8.3 "Teaching-in the position".

↵ Connect a PC/laptop to the smart camera and start the webConfig tool; see chapter 9 "Extended configuration – Leuze electronic webConfig tool".



↵ Calibrate the device for the current check program with the webConfig tool; see chapter 9.3.5 "Calibrating".

8.2 Mechanically aligning the device via the display

Prerequisites:

- The smart camera is correctly mounted; see chapter 6 "Mounting".
The smart camera is correctly connected; see chapter 7 "Electrical connection".
The application data is set via the webConfig tool; see chapter 9.3.4 "Configure compartment fine positioning".
- The lens cover of the smart camera is aligned parallel to the marking (hole or reflector).
- The marking (hole or reflector) is located as close to the middle of the capture range of the smart camera as possible.



Use the navigation buttons   to move through the menu. Activate the desired selection with the enter button .

↵ Press the navigation button  three times.

↵ Press the enter button  to activate *Service* mode.

↵ Select *Commissioning*.

↵ Select the check program for alignment (*Rack Near* or *Rack Far*).

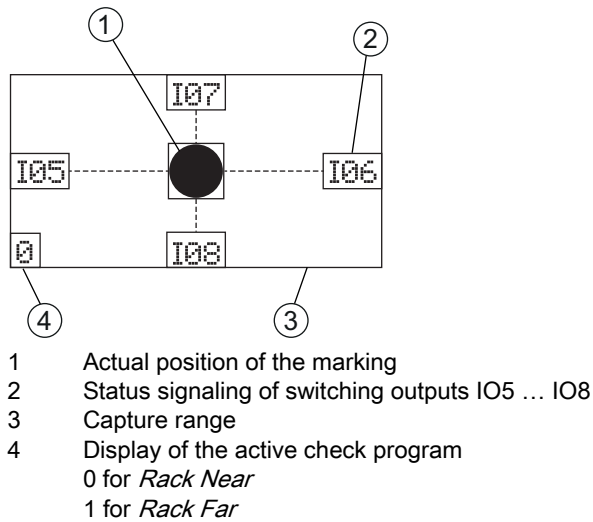

Figure 8.1: Indicators in the display

- A semicircle visible in the position display indicates that the marking is in the field of view of the device but not in the capture range. Turn the device towards the semicircle.

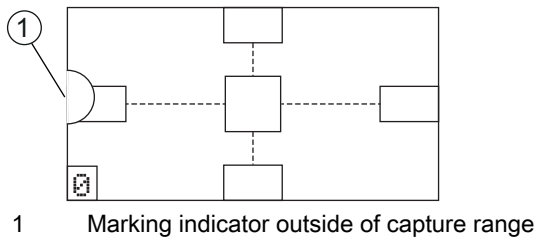

Figure 8.2: Marking in the field of view, but not in the capture range

- A black dot in the position display indicates that the marking is in the capture range of the device. The device is not yet optimally aligned.

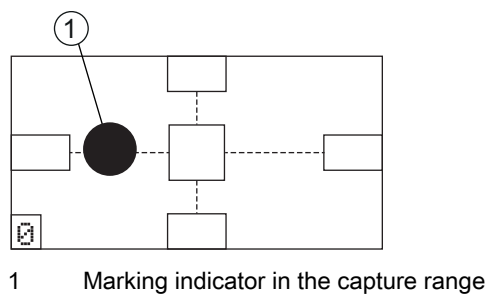

Figure 8.3: Marking in the capture range

- If the marking is not in the field of view of the device (no marking indicator), the device must be mechanically repositioned.
- ☞ Align the device until the marking indicator (black dot) is exactly in the square in the middle of the display.

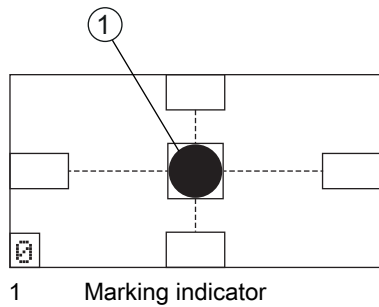

Figure 8.4: Device aligned with the marking

- ↵ Press the escape button to exit *Service* mode.
- ↵ If necessary, teach-in the position for fine adjustment; see chapter 8.3.
- ↵ Calibrate the device for the current check program with the webConfig tool; see chapter 9.3.5 "Calibrating".

8.3 Teaching-in the position

For fine adjustment and, alternatively, for exact mechanical alignment via the *Commissioning* menu, the user can teach-in the position of the device via the display.

While teaching-in the position (teach), a position correction of the coordinate system of the capture range is performed.



Teaching-in of the position is performed separately for each distance.

Reteaching of the position is not performed for a different hole geometry or for different exposure/focal settings.

NOTICE

Align the device before teaching-in the position!

- ↵ The device must be roughly aligned before teaching-in the position.
The capture range must not exit the field of view.
- ↵ For the *Rack Near* distance, the teach range is nearly zero since the field of view is almost the same as the capture range.



Use the navigation buttons to move through the menu. Activate the desired selection with the enter button .

To teach the position for the current alignment, the marking (hole or reflector) must be located within the capture range; see figure 8.3.

- ↵ In *Service* mode, select *Commissioning*.
Select the distance for teaching-in (*Rack Near* or *Rack Far*).
- ↵ Select the *Teach-in* menu.
- ↵ Select *Teach-in*.

If the *Teach-in* menu option is crossed out in the *Teach-in* menu, teaching-in of the position is not possible. Mechanically realign the device; see chapter 8.2 "Mechanically aligning the device via the display".

Possible causes:

- The marking is not in the capture range of the device.
 - The limits of the new capture range ascertained by teaching in are not completely in the field of view.
- ↵ Exit the *Commissioning* menu.
To do this, press the Escape button .



The capture range with the new coordinate origin ascertained by teaching in must be completely in the field of view.

- ↪ Calibrate the device for the current check program with the webConfig tool; see chapter 9.3.5 "Calibrating".



8.4 Parameter enable

During process mode parameters can only be viewed. If parameters are to be changed and for configuration settings via the display, parameter enabling must be activated.

Parameter enabling is activated by default.

If parameter enabling is deactivated, you must activate parameter enabling for the configuration settings via the display.



Use the navigation buttons   to move through the menu. Activate the desired selection with the enter button .

- ↪ In the *Parameter* menu, select the *Parameter handling* option.

- ↪ Select the *Parameter enable* option.

- ↪ Select the *ON* option and press the enter button .

The PWR LED illuminates orange. The device is in Service mode and you can set the configuration parameters via the display.

- ↪ Press the Escape button  to enter the main menu.

9 Extended configuration – Leuze electronic webConfig tool

The smart camera can be operated and configured by means of the integrated webConfig tool via the Ethernet service interface.

With the Leuze electronic webConfig tool, an operating-system independent, web-technology based, graphical user interface is available for the configuration.

The webConfig tool can be run on any Internet-ready PC. The webConfig tool uses HTTP as communication protocol and the client-side restriction to standard technologies (HTML, JavaScript and AJAX) that are supported by modern browsers.



The webConfig tool is offered in the following languages:

German, English, French, Italian, Spanish

9.1 Establishing an Ethernet connection

The Ethernet connection is used as the host interface and for configuring the device via a PC with a browser.



In order for the PC and the smart camera to communicate with one another, both devices must be on the same subnet and have different network addresses.

Address Link Label

The “Address Link Label” is an additional stick-on label that is affixed to the device.

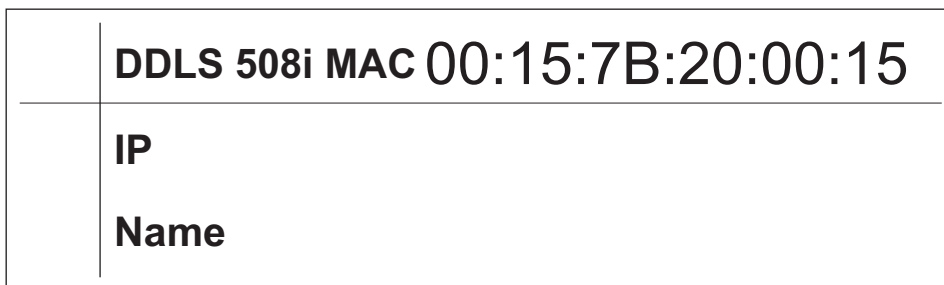

Figure 9.1: Example of an “Address Link Label”; the device type varies depending on series

- The “Address Link Label” contains the MAC address (Media Access Control address) of the device and offers the possibility to enter the IP address and the device name by hand. The area of the “Address Link Label” on which the MAC address is printed can be separated from the remainder of the stick-on label if necessary by means of the perforation.
- To use, the “Address Link Label” is peeled from the device and can be affixed in the installation and layout diagrams to designate the device.
- Once affixed in the documents, the “Address Link Label” establishes a unique reference between mounting location, MAC address or device, as well as the corresponding control program. The time-consuming searching, reading, and manually writing down of the MAC addresses of all devices installed in the system are eliminated.



Each device with Ethernet interface is uniquely identified via the MAC address assigned during production. The MAC address is also listed on the name plate of the device.

If multiple devices are commissioned in a system, the MAC address of each installed device must be correctly assigned, e.g., during programming of the control.

Connecting smart camera to a PC/laptop without network

Check the network address of the smart camera.

↪ On the display, select *Status > Network settings*.

↪ Note the values for *Addr* and *Mask*.

Set the network address on the PC/laptop (example for Windows7).

- ☞ Log in as administrator.
Select *Start > Control Panel > Network and Internet > Network and Sharing Center*.
- ☞ Select *LAN connection* and right-click to open the *Properties* dialog.
- ☞ Select *Internet Protocol Version 4 (TCP/IPv4)* and click on the [Properties] button.
- ☞ Set the *IP address* of the PC/laptop.
The IP address of the PC/laptop must not be identical to the IP address of the smart camera.
Example: IP address of the smart camera: 192.168.060.101
IP address of the PC/laptop: 192.168.060.111
- ☞ Set the subnet mask of the PC/laptop to the same value as on the smart camera.
Example: 255.255.255.0
- ☞ Confirm all of the settings dialogs with [OK] or [Close].
- ☞ Connect the SERVICE interface of the smart camera directly to the LAN port of your PC/laptop.

9.2 Start webConfig tool

Prerequisite: IP address and subnet mask for the LAN connection with the device are set correctly.

- ☞ Connect the operating voltage to the device.
- ☞ Connect the SERVICE interface of the device to the PC.
The connection to the SERVICE interface of the device is made via the LAN port of the PC.
- ☞ Start the webConfig tool via your PC's Internet browser with IP address **192.168.60.101** or with the IP address set by you.

192.168.60.101 is the standard Leuze electronic service address for communication with the smart camera of the LSiS 4xxi series.

The webConfig start page is displayed on your PC.

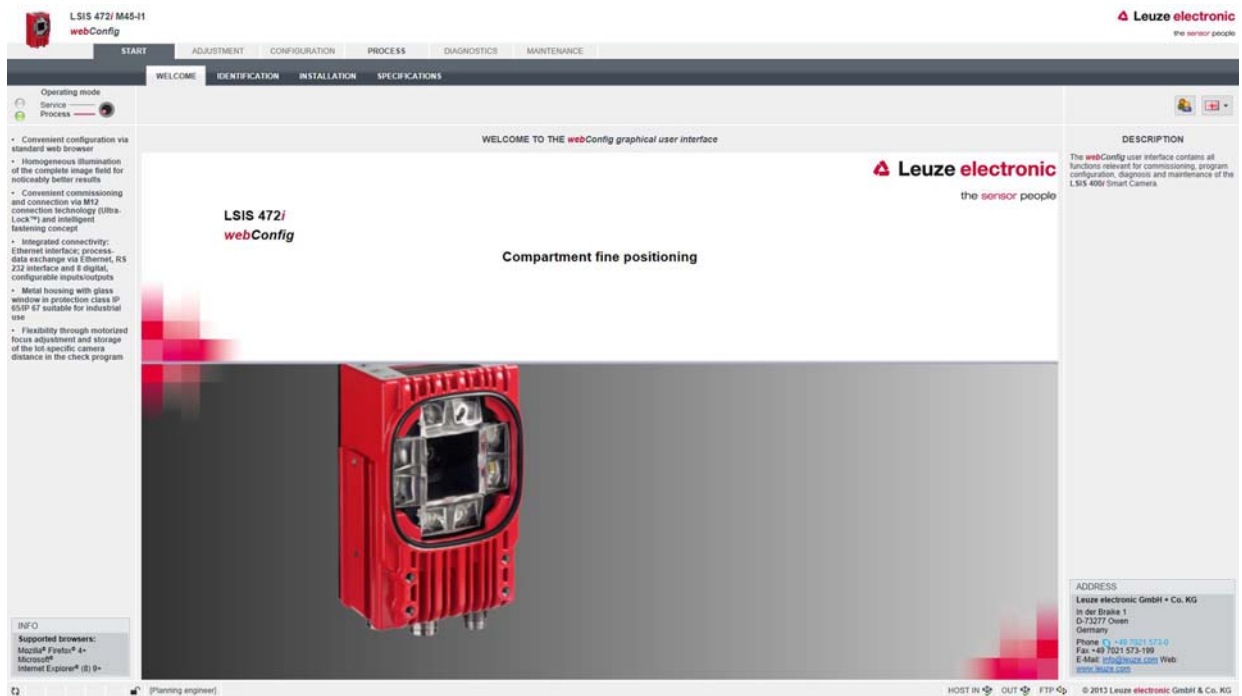

Changing the operating mode (*Process - Service*) (upper left)

Figure 9.2: The start page of the webConfig tool

The user interface of the webConfig tool is largely self-explanatory.



The webConfig tool is completely contained in the firmware of the device.

The pages and functions of the webConfig tool may appear and be displayed differently depending on the firmware version.

Clearing browser history

The cache of the Internet browser is to be cleared if different device types or devices with different firmware were connected to the webConfig tool.

↵ Delete cookies and temporary Internet and website data from the browser cache before starting the webConfig tool.

Example for Internet Explorer 10:

Tools > Delete browsing history > [Delete]

Note limit of Firefox sessions for version 17.0 and higher

If the limited number of Firefox sessions is exceeded, it may no longer be possible to address the device via the webConfig tool.

↵ Do **not** use the refresh functions of the Internet browser:
[Shift] [F5] or [Shift] + mouse click

9.3 Short description of the webConfig tool

The menus and dialog boxes of the webConfig tool are intuitive to operate and offer help texts and tool tips.

9.3.1 Operating modes

For configurations with the webConfig tool, you can switch between the following operating modes:

- *Process*
The device is connected to the control.
 - The process communication to the control is activated.
 - The switching inputs/outputs are activated.
 - The configuration cannot be changed.
 - *PROCESS* function available.
 - *CONFIGURATION* function not available.
- *Service*
 - The process communication to the control is interrupted.
 - The switching inputs/outputs are deactivated.
 - The configuration can be changed.
 - *PROCESS* function not available.
 - *CONFIGURATION* function available.

9.3.2 Configuration via the webConfig tool

Use webConfig tool to set up the device:

- ↵ Select the check program; see chapter 9.3.3.
- ↵ Configure compartment fine positioning for fast commissioning; see chapter 9.3.4.
- ↵ Calibrate the device; see chapter 9.3.5.
- ↵ Configure the image acquisition; see chapter 9.3.6.
- ↵ Define the changeover of the check programs; see chapter 9.3.9.
- ↵ Configure the BLOB analysis; see chapter 9.3.7.
- ↵ Configure the measurement; see chapter 9.3.8.
- ↵ Configure the digital switching input/outputs; see chapter 9.3.10.
- ↵ Assign measurement values to the digital switching outputs; see chapter 9.3.11.
- ↵ Activate the marking display on the display; see chapter 9.3.12.
- ↵ Configure the output via an FTP connection; see chapter 9.3.13.
- ↵ Configure the output via an Ethernet connection; see chapter 9.3.14.

NOTICE

Configuration changes only in the *Service* operating mode!

↳ Changes made using the *CONFIGURATION* function can only be performed in the *Service* operating mode.

9.3.3 Selecting the check program

There is a check program stored on the device for the detection of both the *Rack Near* and *Rack Far* hole positions.

↳ Select *CONFIGURATION > PROGRAMS*.

The *Overview of Check Programs* dialog is displayed.

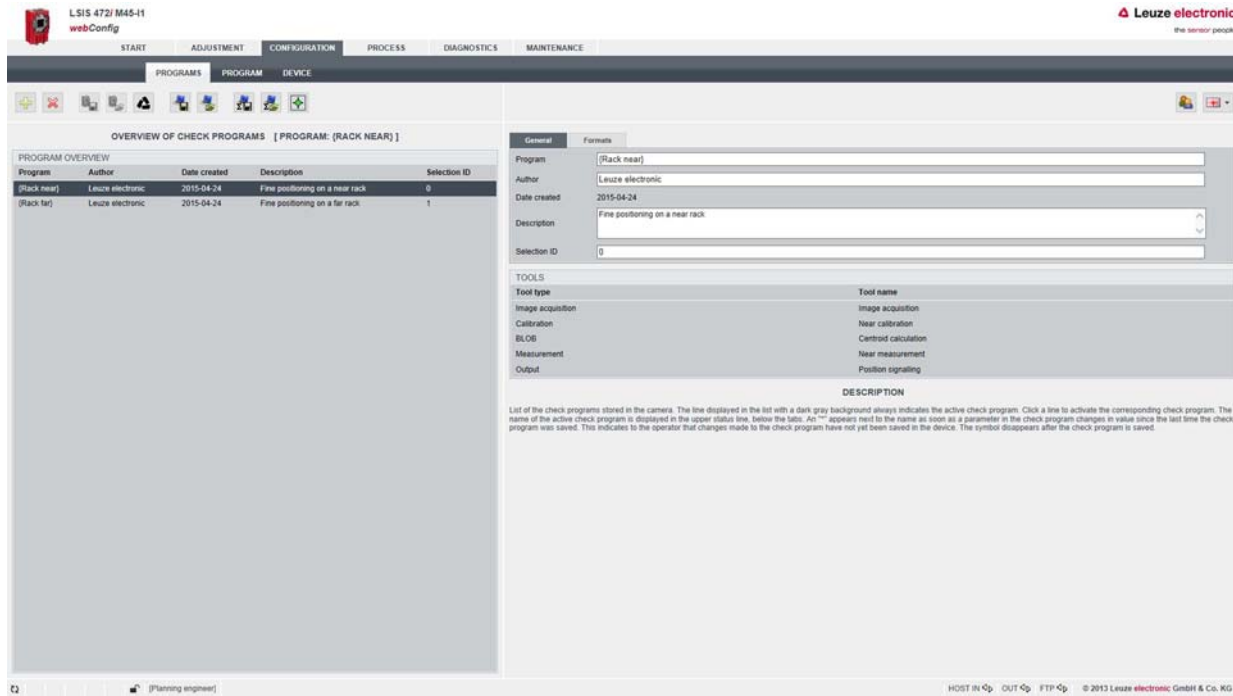

Figure 9.3: *Overview of Check Programs*

↳ Select the check program that you would like to activate (*Rack Near* or *Rack Far*).

Table 9.1: Overview of digital inputs for check programs

Digital input IO2	Digital input IO3	Selection ID	Check program
0	0	0	<i>Rack Near</i>
1	0	1	<i>Rack Far</i>
0	1	2	Not defined
1	1	3	Not defined

9.3.4 Configure compartment fine positioning

To commission more quickly, you can set the most important parameters for the check programs (*Rack Near* and *Rack Far*) via a configuration dialog.

Alternatively, you can make the configuration settings for compartment fine positioning manually; see chapter 9.3.6.



The configuration for compartment fine positioning for faster commissioning is only available if the device is directly connected to the PC/laptop.

↪ Select *CONFIGURATION > PROGRAMS*.

↪ Click on the [Configure compartment fine positioning] button.

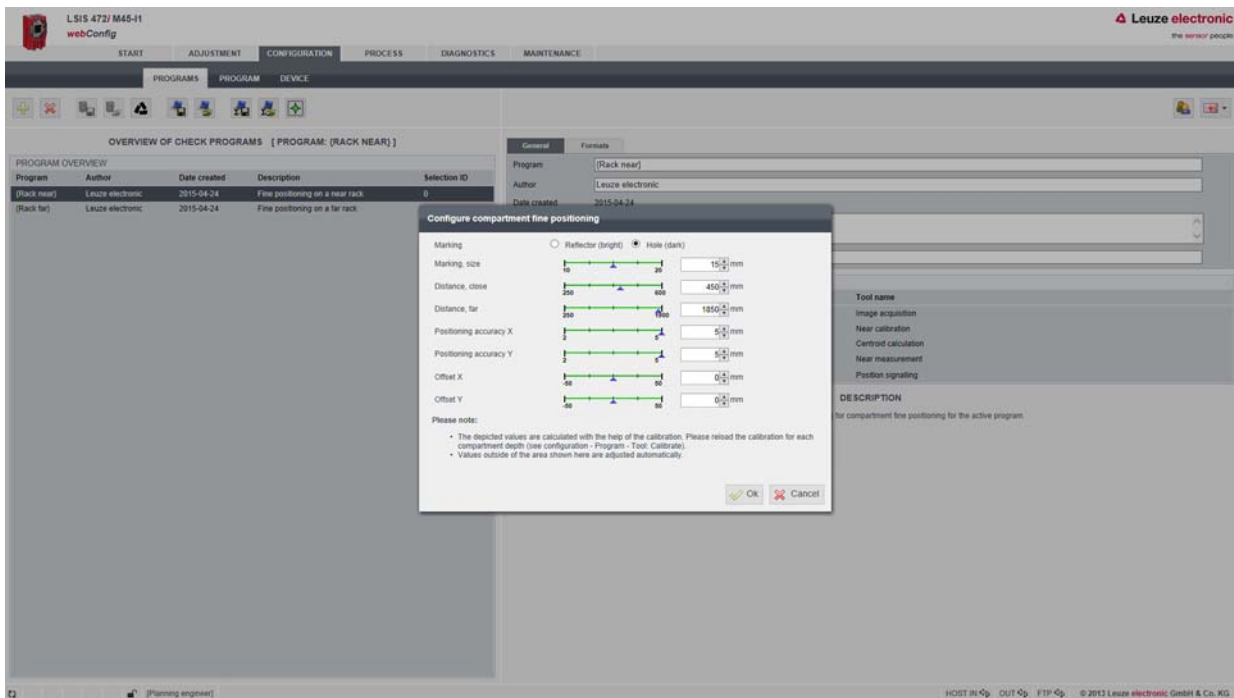

Figure 9.4: *Configure compartment fine positioning* dialog

↪ Enter the type and diameter of the marking.

↪ Enter the distance between rack profile and lens cover of the device.



For a single-depth warehouse, enter the same distance under *Rack Near* and *Rack Far*.

↪ Enter the positioning accuracy for the active check program.

The positioning accuracy is determined over a rectangular positioning area depending on the diameter of the marking. If the device sees the marking within this area, positioning of the high-bay storage device is concluded (IO5 ... IO8 = 1).

Example:

- Diameter of the marking: 15 mm
- Positioning accuracy X: 5 mm
- Positioning accuracy Y: 5 mm

If the device sees the marking within an area of 25 mm x 25 mm around the center of the marking, all switching outputs switch to 1.

↪ Enter the offset values for the active check program.

The offset can be used to enter a deviation of the positioning relative to the middle of the marking, e.g., to take into account the difference in positioning between loading position and unloading position of the high-bay storage device.

↪ Confirm all entries with [OK].

9.3.5 Calibrating

During device calibration, the measurement distance is calibrated with the diameter of the marking.

↪ Select *CONFIGURATION > PROGRAMS*.

↪ Select the active check program (*Rack Near* or *Rack Far*).

↪ Select *CONFIGURATION > PROGRAM > Tools > Calibration*.

The *Tool configuration – Calibration* dialog is displayed.

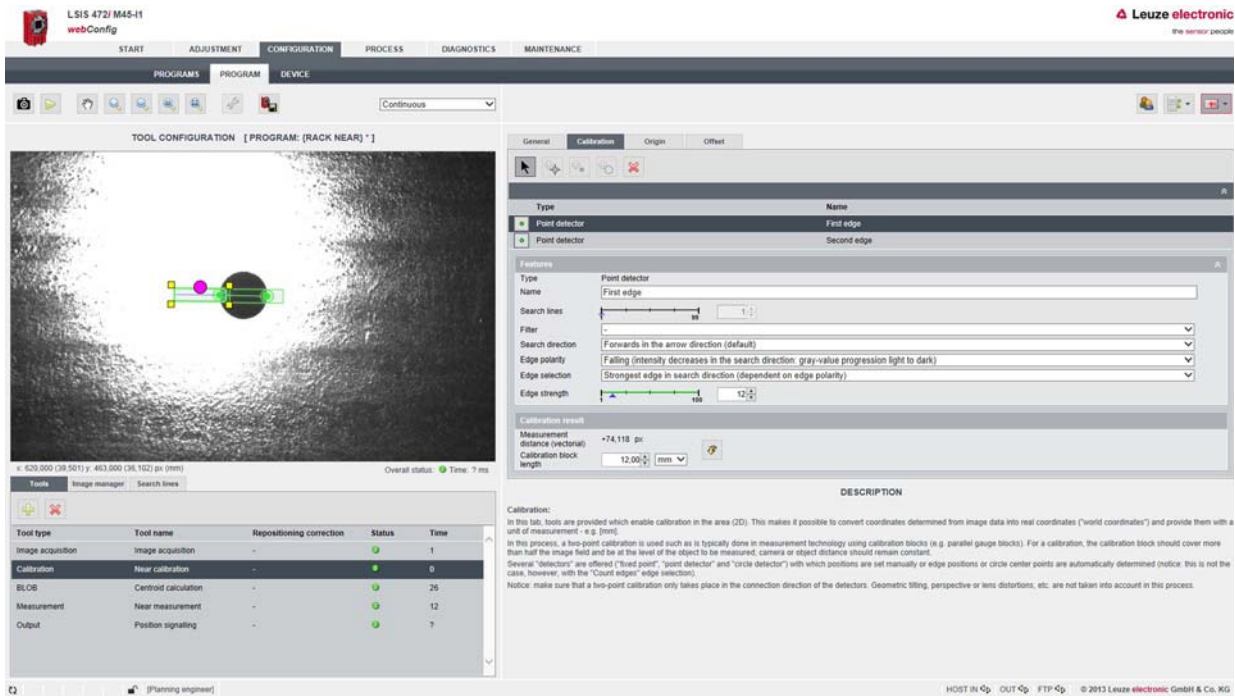

Figure 9.5: Tool configuration – Calibration dialog

NOTICE

Recalibration required if the measurement distance changes!

↪ If the distance for the check program (*Rack Near* or *Rack Far*) changes in the application, the calibration must be adjusted.

↪ Calibrate via the point detectors if necessary.

↪ Enter the diameter of the marking (hole or reflector) in the selection list [Calibration block length].

↪ Click on the [Accept values] button.

Setting the offset

For the current check program, you can set additional distances (offsets) for the positioning. By means of the offset value, it is possible to detect, e.g., the position difference between loading position and unloading position of the high-bay storage device.

- If the offset values are 0, the smart camera positions the high-bay storage device exactly on the marking.
- If offset values are set, the control signals a corresponding position deviation.
Example: with offset Y = 20 mm, the high-bay storage device is positioned 20 mm below the marking.

i The offset is not visualized in the image.

↪ Select *CONFIGURATION > PROGRAMS*.

↪ Select the active check program (*Rack Near* or *Rack Far*).

↪ Select *CONFIGURATION > PROGRAM > Tools > Calibration > Offset*.

The *Tool configuration – Offset* dialog is displayed.

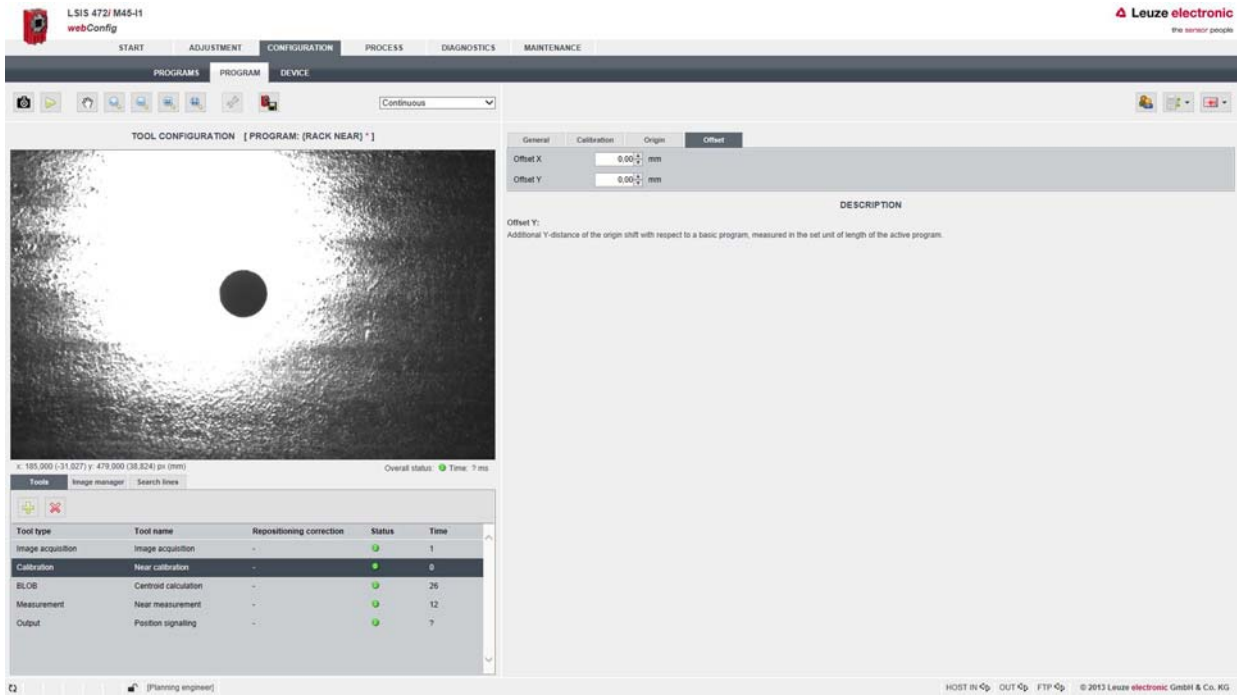

Figure 9.6: Tool configuration – Offset dialog

9.3.6 Configuring image acquisition

As an alternative to configuring compartment fine positioning for faster commissioning (see chapter 9.3.4), you can make the configuration settings for compartment fine positioning manually.

- ↳ Select *CONFIGURATION > PROGRAMS*.
 - ↳ Select the active check program (*Rack Near* or *Rack Far*).
 - ↳ Select *CONFIGURATION > PROGRAM > Tools > Image acquisition*.
- The *Image acquisition – Attributes* dialog is displayed.

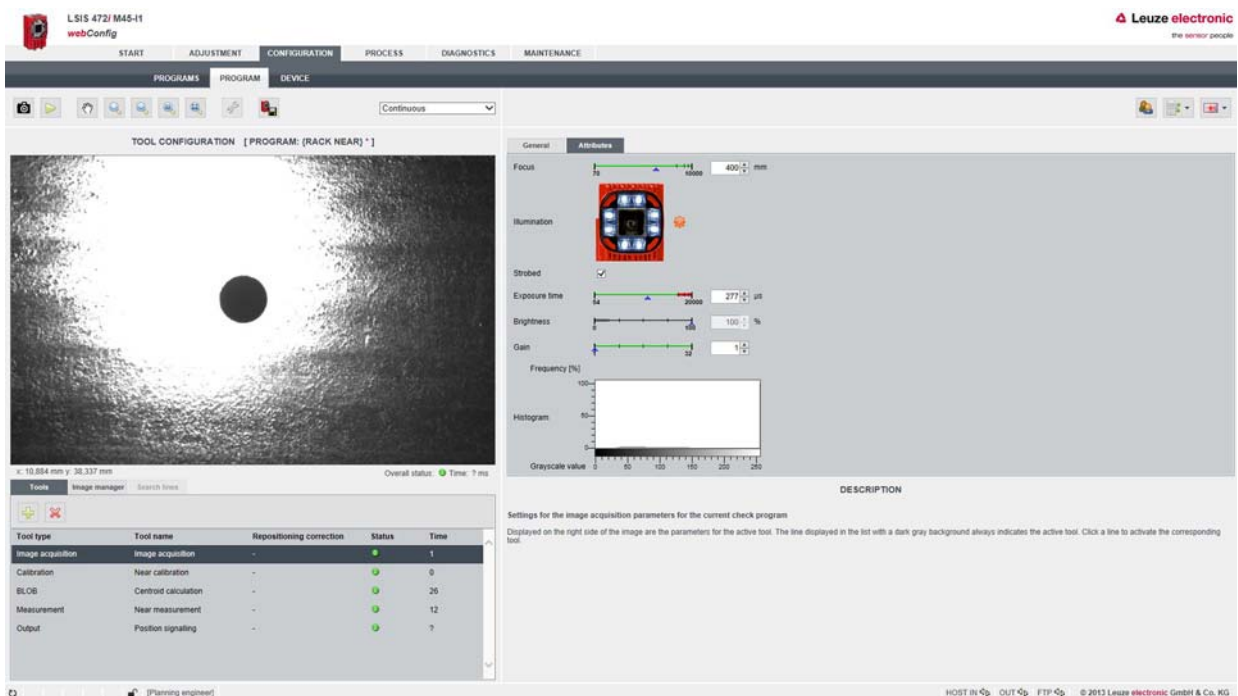

Figure 9.7: Image acquisition – Attributes dialog

- ↳ Set the image acquisition attributes according to the requirements of the application.

NOTICE

Adjust exposure time and focus if the distance is changed!

- ↪ If the distance for the check program (*Rack Near* or *Rack Far*) changes in the application, the exposure time and focus must be checked or adjusted.
 - ↪ When adjusting the focus, the same value must be set for the *Rack Near* and *Rack Far* check programs.
- For two compartments with different distances, use the mathematical average of the distances as the focal distance.

9.3.7 Configuring the BLOB analysis

The centroid of the marking for the display in the image is ascertained via the BLOB analysis.

- ↪ Select *CONFIGURATION > PROGRAMS*.
- ↪ Select the active check program (*Rack Near* or *Rack Far*).

BLOB segmentation

- ↪ Select *CONFIGURATION > PROGRAM > Tools > BLOB > Segmentation*.

The *BLOB segmentation* dialog is displayed.

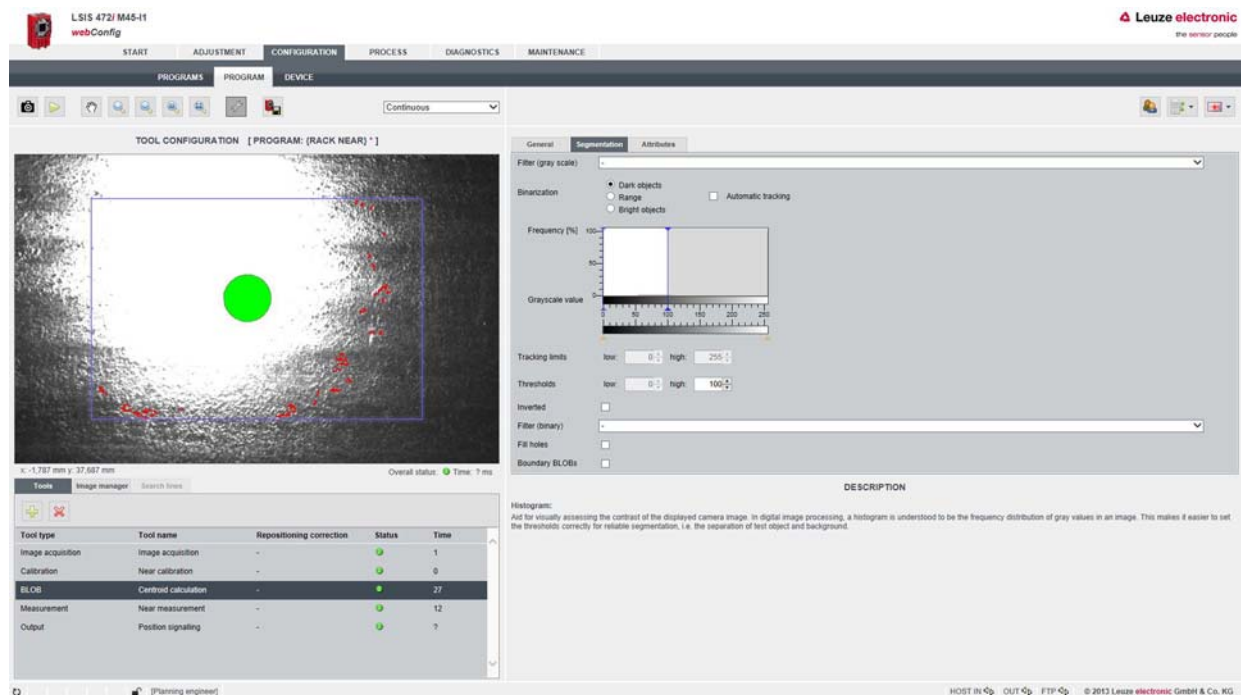

Figure 9.8: *BLOB segmentation* dialog



The display for the marking must lie completely in the capture range (blue frame).

- ↪ Set the attributes for BLOB segmentation according to the requirements of the application.
- ↪ Under *Binarization*, set the type of marking:
 Hole: *Dark objects*
 Reflector: *Bright objects*

BLOB attributes

- ↪ Select *CONFIGURATION > PROGRAM > Tools > BLOB > Attributes*.
- The *BLOB prefiltering* dialog is displayed.

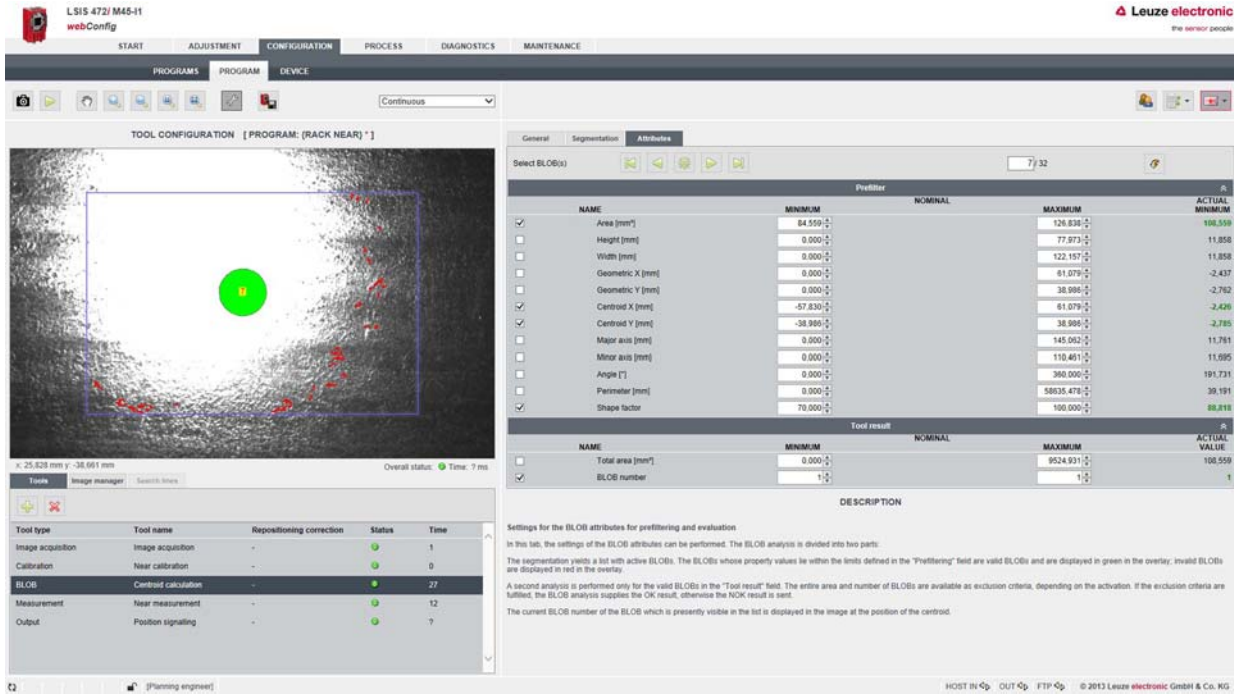

Figure 9.9: BLOB prefiltering dialog

- ↪ Area attribute: adjust the NOMINAL limit values if the geometry of the marking has changed.
- ↪ Shape factor attribute: adjust the NOMINAL limit values if the geometry of the marking has changed.
- ↪ Centroid X, Centroid Y attributes: the limits of the centroid values must not be changed.

9.3.8 Configuring the measurement

- ↪ Select CONFIGURATION > PROGRAMS.
 - ↪ Select the active check program (Rack Near or Rack Far).
 - ↪ Select CONFIGURATION > PROGRAM > Tools > Measurement > Testing.
- The Measurement - Testing dialog is displayed.

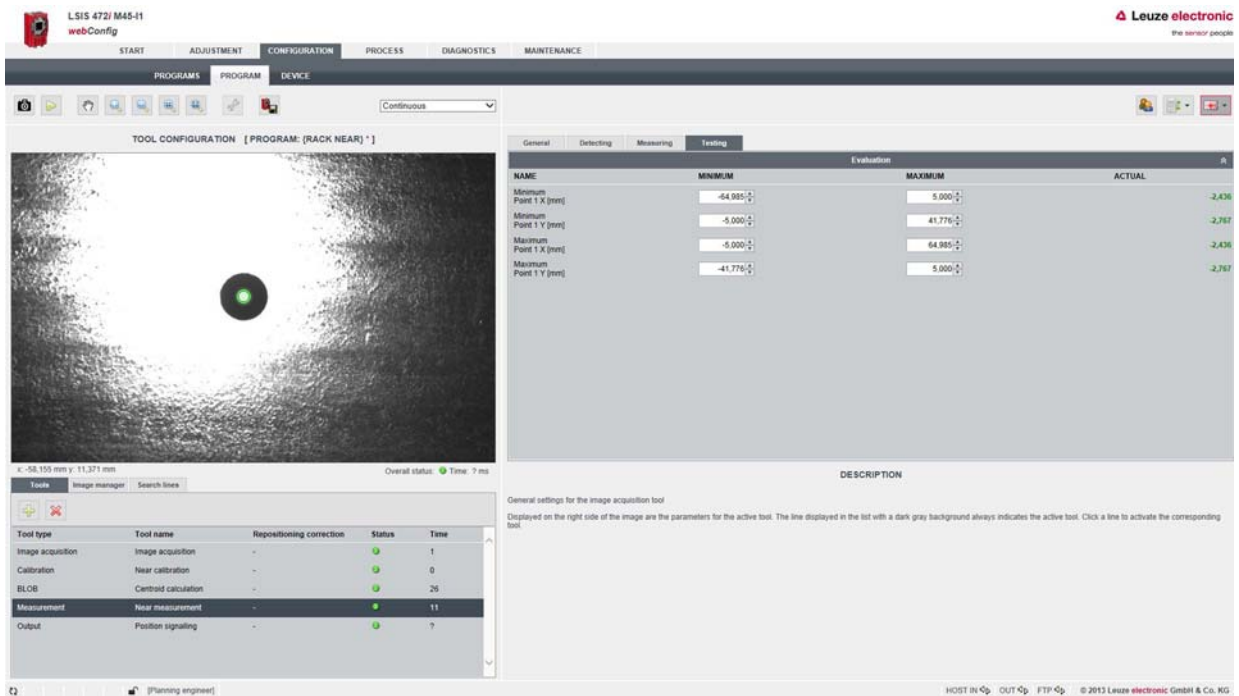

Figure 9.10: Measurement - Testing dialog

- ↪ Define the limits for the measurement.

The MINIMUM values for *Minimum Y* and *Maximum X* and the MAXIMUM values for *Minimum X* and *Maximum Y* correspond to the limits for the positioning accuracy X and Y.

NOTICE

Adjust limit values if the tolerance areas are changed!

↪ If the tolerance areas change in the application, the limit values in the *Measurement - Evaluation* dialog must be checked and adjusted if necessary.

The minimum value for this application is 2 mm.

9.3.9 Defining changeover of the check programs

In Process mode, you can switch between the *Rack Near* and *Rack Far* check programs.

↪ Select *CONFIGURATION > DEVICE > Digital I/Os > General parameters*.

The *CONFIGURATION OF DIGITAL I/Os* dialog is displayed.

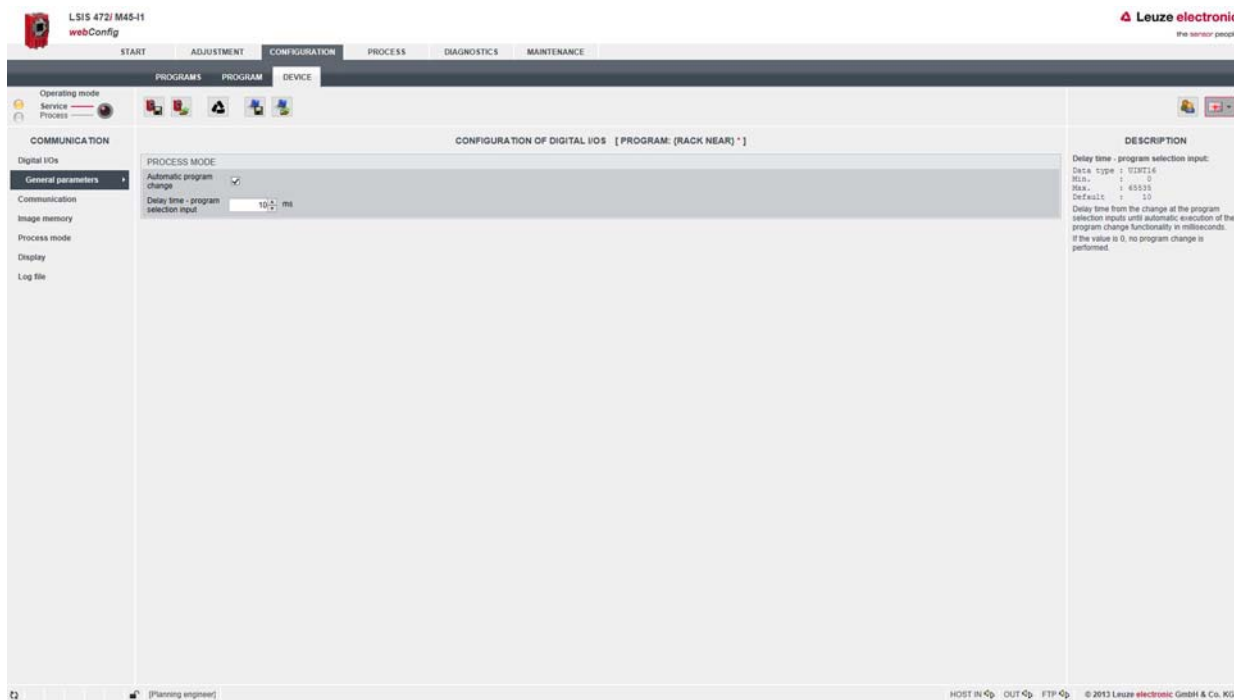

Figure 9.11: *CONFIGURATION OF DIGITAL I/Os* dialog

↪ Activate the *Automatic program change* checkbox for changing the check programs via digital switching inputs IO2 and IO3.

The signals for program selection on the inputs must currently be applied.

- If the signals are removed at the inputs while the *Automatic program change* checkbox is selected, the device interprets this as a “logical low” pending signal and activates the check program with selection ID 0 (*Near Rack*).
- If the *Automatic program change* checkbox is not selected, the check program confirmation must be performed via a “program change” input.

↪ Define the *Delay time - program selection input*.

The delay time defines the time that the input signals must be applied to the device before a change to an edge results in a change of check program. The delay time protects against faulty activations since it takes up to 300 ms for the check program to changeover.

For technical reasons, it is not possible to implement an immediate changeover (delay time = 0 ms). If the delay time is set to 0 ms, the functionality is deactivated. This corresponds to unselecting the *Automatic program change* checkbox.

9.3.10 Configuring the digital switching inputs/outputs

The digital switching inputs/outputs are configured for the active check program via the *DEVICE* configuration dialog.

- ↪ Select *CONFIGURATION > PROGRAMS*.
 - ↪ Select the active check program (*Rack Near* or *Rack Far*).
 - ↪ Select *CONFIGURATION > DEVICE > Digital I/Os*.
- The *CONFIGURATION OF DIGITAL I/Os* dialog is displayed.



Figure 9.12: *CONFIGURATION OF DIGITAL I/Os* dialog

- ↪ Set the configuration of the digital switching inputs/outputs according to the requirements of the application.

Table 9.2: Factory settings of the digital switching inputs/outputs

IO port	IO mode	Function
IO1	Input	Activation - program start Reading gate start/stop
IO2	Input	Program selection 1
IO3	Input	Program selection 2
IO4	Input	Error image memory active Start writing images to ring buffer
IO5 ... IO8	Output	Programmable 1 ... 4 Outputs for compartment fine positioning

9.3.11 Assigning digital switching outputs the measurement values

Check-program-specific assignment of tool results to the programmable digital switching outputs.

- ↪ Select *CONFIGURATION > PROGRAMS*.
 - ↪ Select the active check program (*Rack Near* or *Rack Far*).
 - ↪ Select *CONFIGURATION > PROGRAM > Tools > Output > Digital I/O*.
- The *TOOL CONFIGURATION - Digital I/O* dialog is displayed.

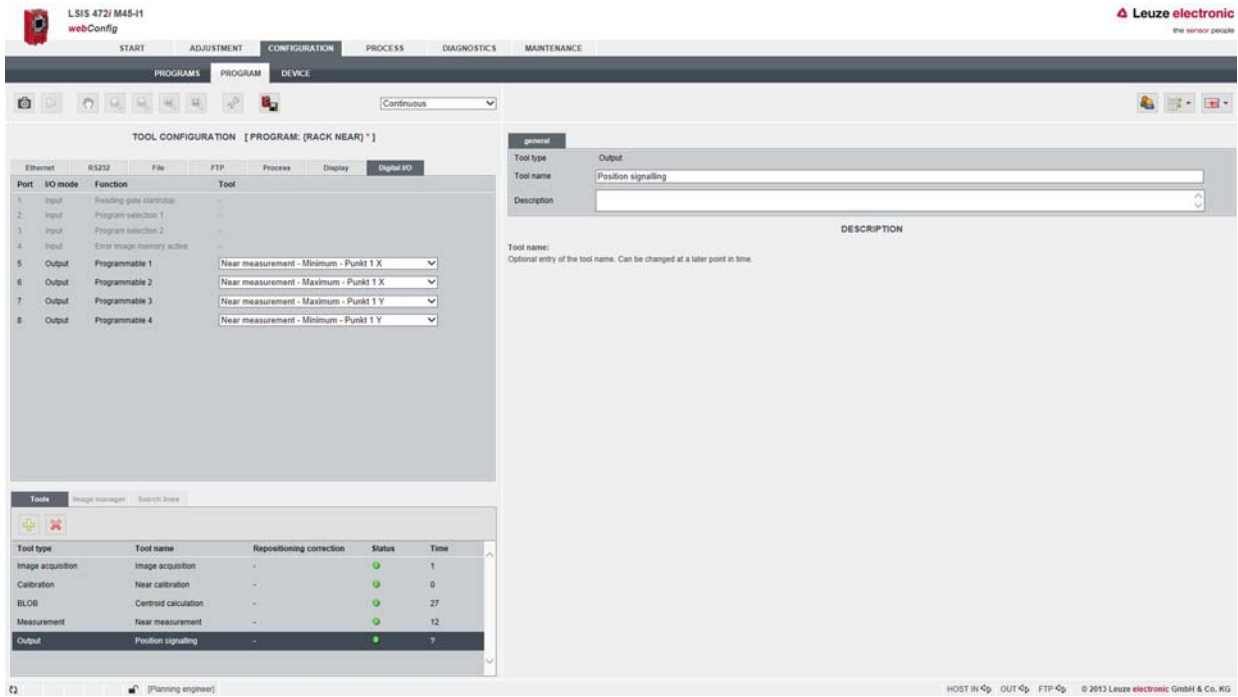

Figure 9.13: *TOOL CONFIGURATION - Digital I/O* dialog

↪ For each switching output, select the desired measurement value that is to be output via the switching output.

↪ Click on the [Save changes] button.

The smart camera makes available digital switching outputs -X, +X, -Y, +Y. In addition, the status of these switching outputs appears on the display.

The target position is located within a rectangular tolerance area. Depending on the X deviations and Y deviations, the switching outputs are switched as follows.

- IO5=-X
- IO6=+X
- IO7=+Y
- IO8=-Y

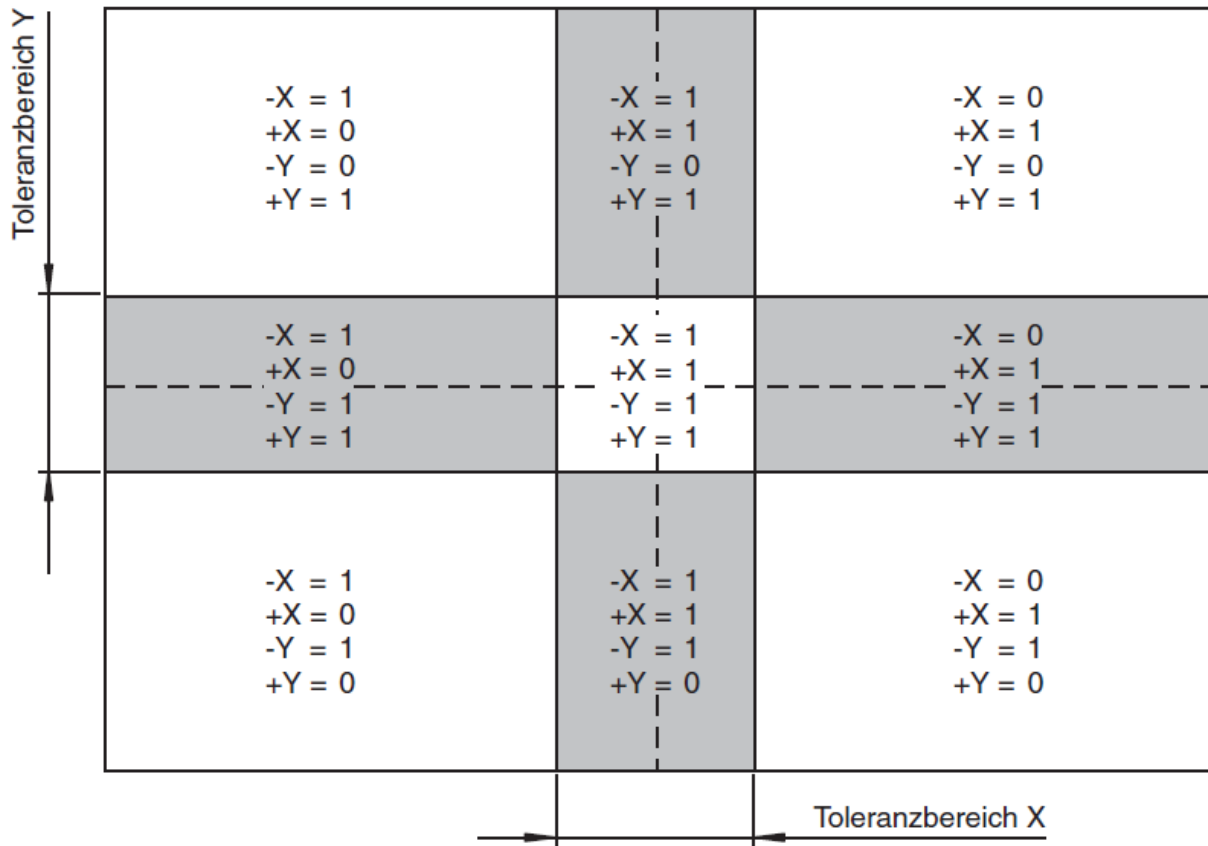

Figure 9.14: Switching of the switching outputs

9.3.12 Activating display of the target/actual deviation in the display

In order for the target/actual deviation for the marking to be shown in the display, the output must be activated via the Ethernet interface.

- ↪ Select *CONFIGURATION > PROGRAMS*.
- ↪ Select the active check program (*Rack Near* or *Rack Far*).
- ↪ Select *CONFIGURATION > PROGRAM > Tools > Output > Display*.

The *TOOL CONFIGURATION - Display* dialog is displayed.

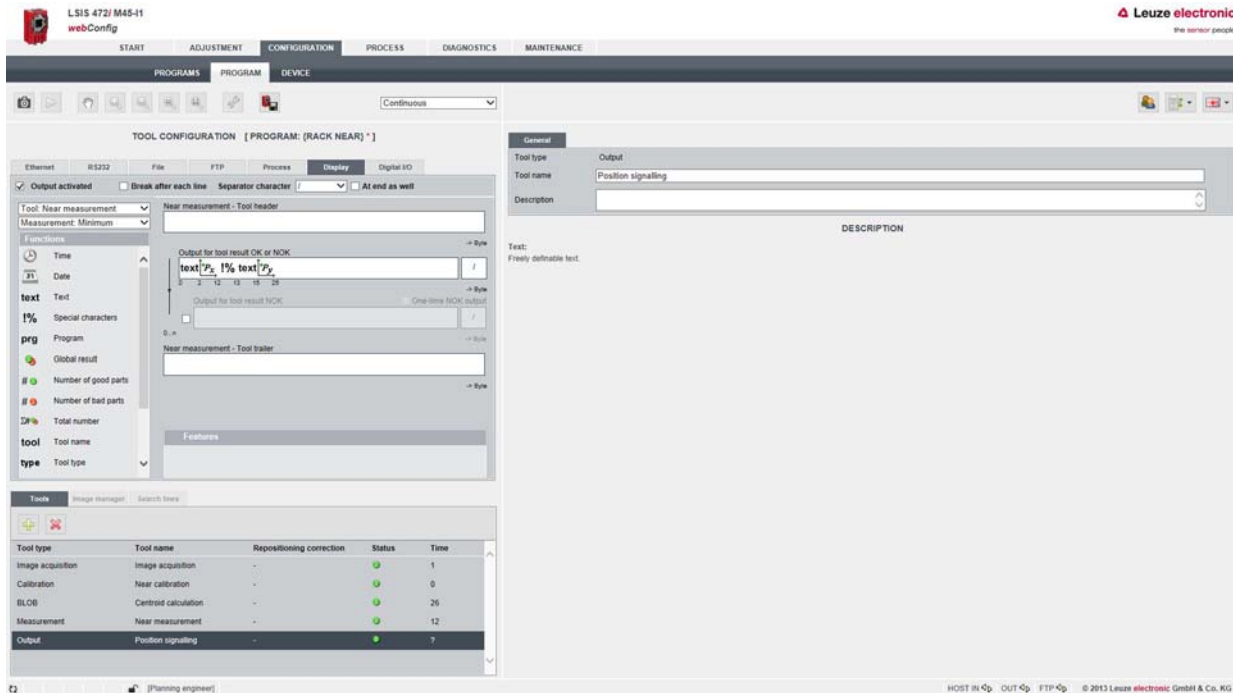

Figure 9.15: *TOOL CONFIGURATION - Display* dialog

- ☞ Select the *Output activated* checkbox.
- ☞ Click on the [Save changes] button.

9.3.13 Configuring the FTP output

Check-program-specific output of test results on the Ethernet interface via the FTP protocol.

- ☞ Select *CONFIGURATION > DEVICE > Communication > FTP client*.
- The *FTP CLIENT* dialog is displayed.

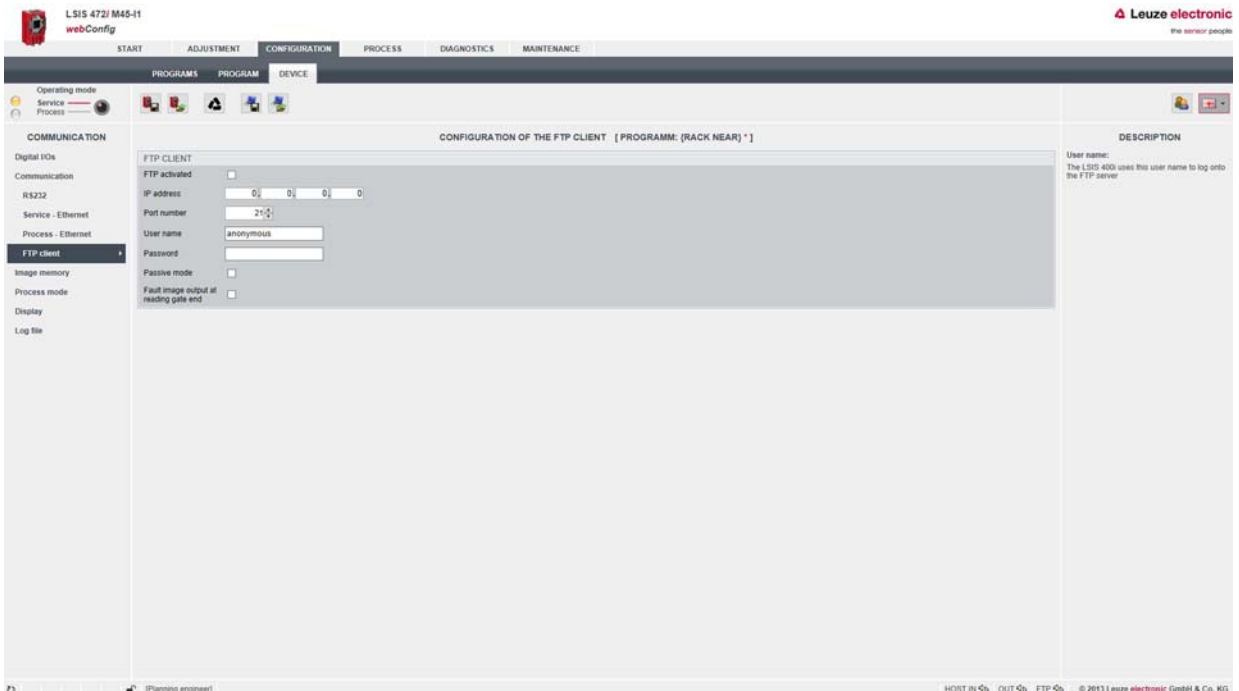

Figure 9.16: *FTP CLIENT* dialog

☞ Make the following entries:

- *IP address*: IP address of the FTP server with which the connection is to be established.
- *Port number*: port number of the FTP server with which the connection is to be established.
Standard setting: port 21
- *User name*: freely selectable user name. The device logs into the FTP server with this user name.
- *Password*: only necessary if required by the FTP server for login.

☞ Select the *Fault image output at reading gate end* checkbox.

☞ Select the *FTP activated* checkbox.

Settings for the FTP connection

NOTICE

Ensure availability of the FTP server

☞ Ensure the availability of your FTP server. If no FTP connection can be established, the device outputs warning messages repeatedly.

☞ Select *CONFIGURATION > PROGRAMS*.

Select the active check program (*Rack Near* or *Rack Far*).

☞ Select *CONFIGURATION > PROGRAM > Tools > Output > FTP*.

The *TOOL CONFIGURATION - FTP* dialog is displayed.

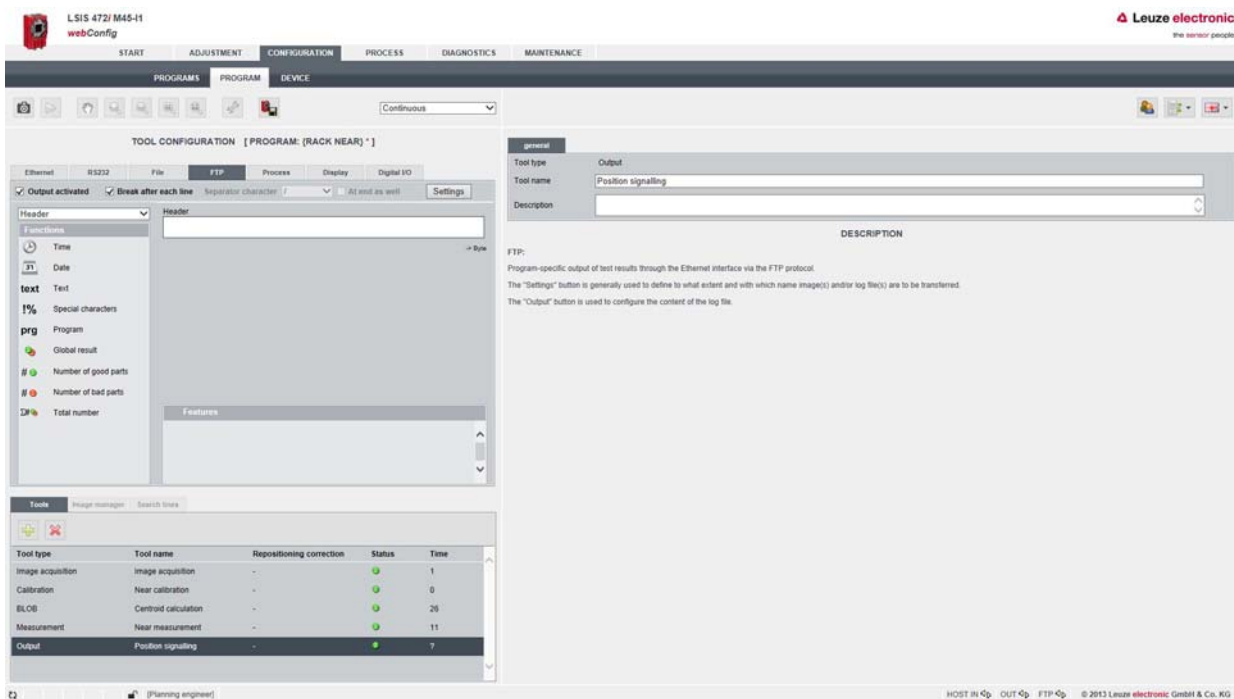

Figure 9.17: *TOOL CONFIGURATION - FTP* dialog

☞ Select the *Output activated* checkbox.

☞ Click on the [Settings] button.

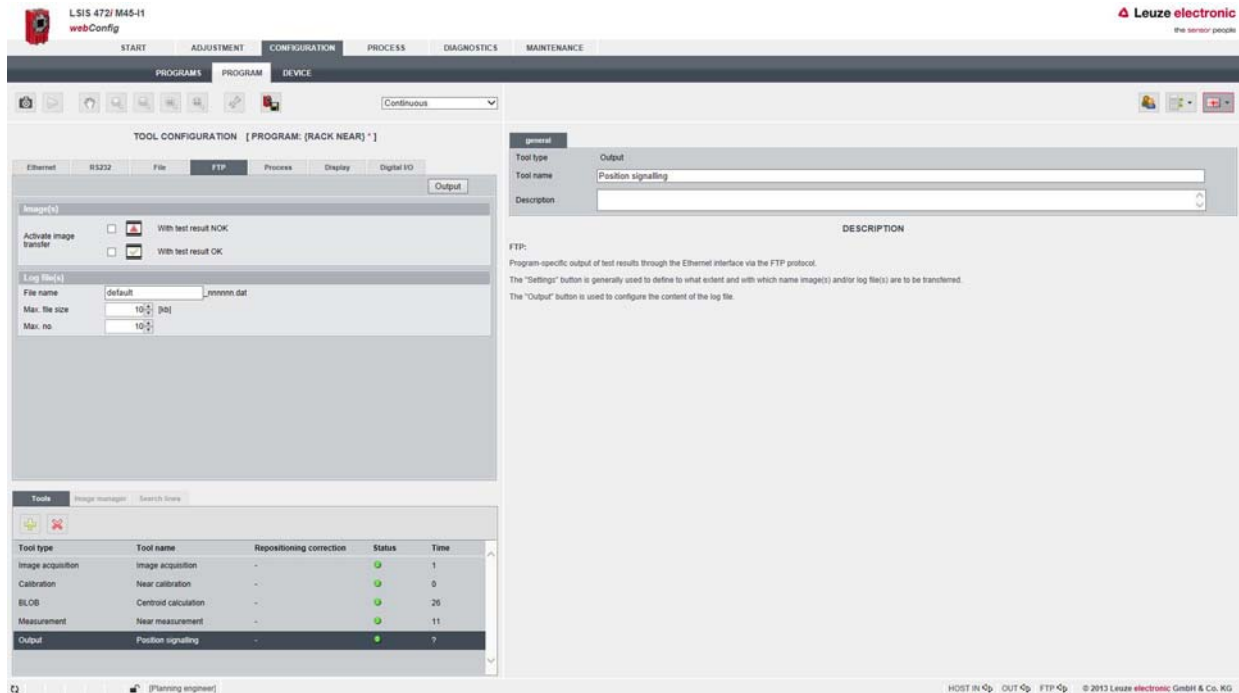

Figure 9.18: Settings for FTP output

☞ Make the following settings:

- *Activate image transfer*: select the two checkboxes.
- *Image name*: assign an image name, e.g., “HBS1_rack1”. The image name must not contain any space characters.
- *Image filing*: select the *with time stamp* option.

☞ Click on the [Save changes] button.

9.3.14 Configuring the Ethernet output

Check-program-specific output of test results on the Ethernet interface via the Ethernet protocol.

☞ Select *CONFIGURATION > DEVICE > Communication > Process - Ethernet*.

The *CONFIGURATION OF ETHERNET COMMUNICATION* dialog is displayed.

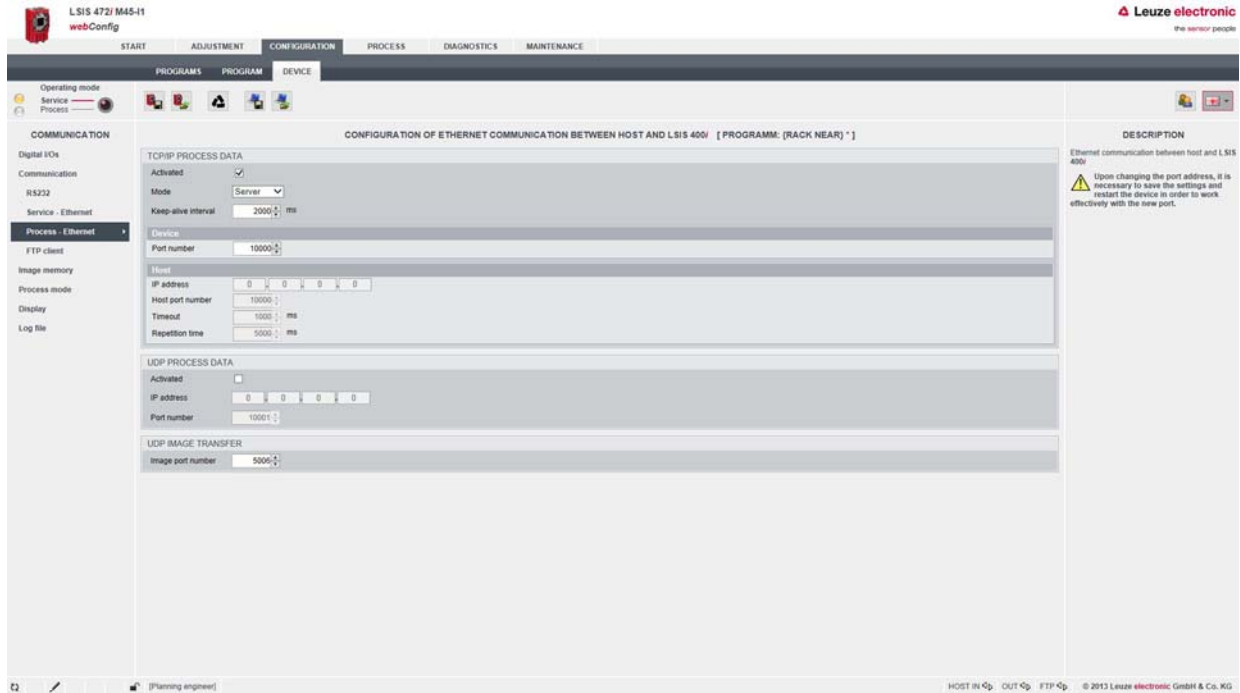

Figure 9.19: CONFIGURATION OF ETHERNET COMMUNICATION dialog

Make the following settings in the *TCP/IP PROCESS DATA* dialog:

- Select the *Activated* checkbox.
- Select *Mode: Server* or *Client*.
If you select *Client* mode, you must configure host communication.

Settings for the Ethernet output of target/actual value deviation

- ↪ Select *CONFIGURATION > PROGRAM*.
 - ↪ Select the active check program (*Rack Near* or *Rack Far*).
 - ↪ Select *CONFIGURATION > PROGRAM > Tools > Output > Ethernet*.
- The *TOOL CONFIGURATION - Ethernet* dialog is displayed.

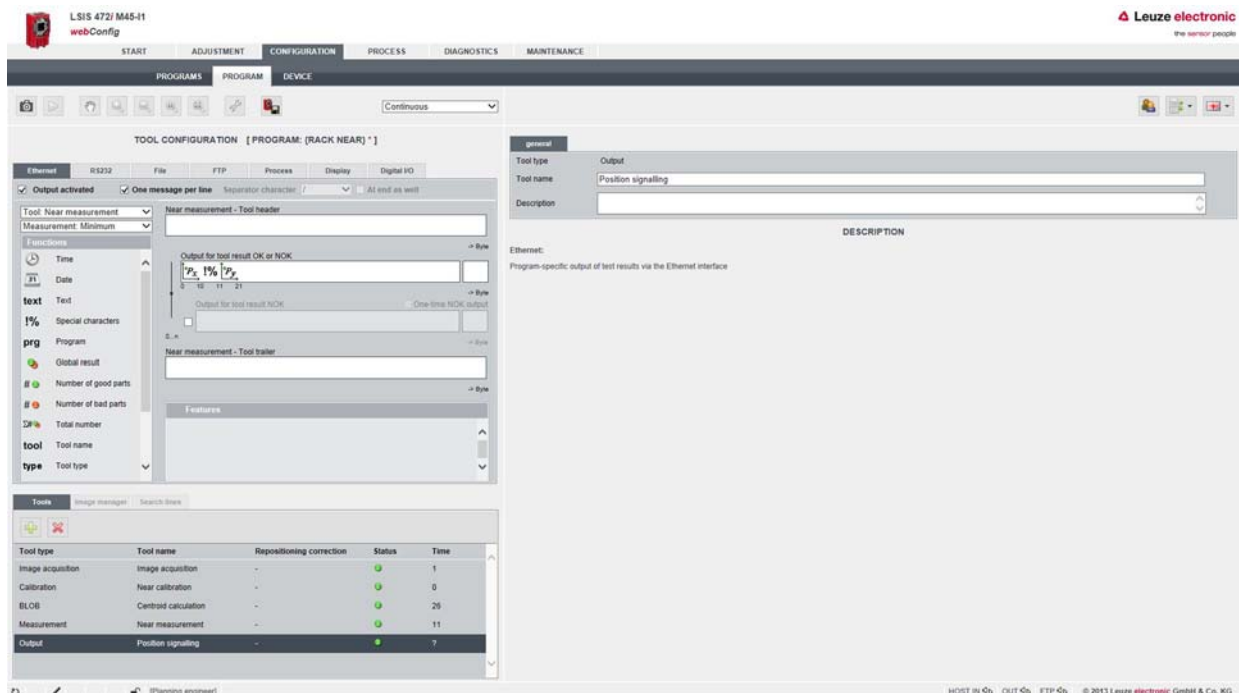

Figure 9.20: TOOL CONFIGURATION - Ethernet dialog

↪ Select the *Output activated* checkbox.

- ↵ In the drop-down lists, select *Tool: Near measurement* and *Measurement: Minimum*.
- ↵ Drag the *Point 1 X* and *Point 1 Y* functions into the *Output for tool result OK or NOK* field.



These settings are stored as standard settings.

- ↵ Click on the [Save changes]button.

10 Troubleshooting

Error signaling via LED

Table 10.1: Meaning of the LED indicators

Faults	Possible error causes	Measures
PWR LED		
Off	<ul style="list-style-type: none"> No supply voltage connected to the device Hardware error 	<ul style="list-style-type: none"> Check supply voltage Contact Leuze electronic customer service(see chapter 12)
Orange, continuous light	Device in Service mode	Reset Service mode via webConfig or display
Red, continuous light	Internal device error	Contact Leuze electronic customer service(see chapter 12)
Red, flashing	Warning set	Query diagnostic data and carry out the resulting measures
BUS LED		
Off	<ul style="list-style-type: none"> No supply voltage connected to the device Hardware error 	<ul style="list-style-type: none"> Check supply voltage Contact Leuze electronic customer service(see chapter 12)
Red, flashing	Communication error	Check interface

11 Care, maintenance and disposal

11.1 Cleaning

If there is dust on the device:

- ↳ Clean the device with a soft cloth; use a cleaning agent (commercially available glass cleaner) if necessary.

NOTICE
<p>Do not use aggressive cleaning agents!</p> <ul style="list-style-type: none"> ↳ Do not use aggressive cleaning agents such as thinner or acetone for cleaning the device. Use of improper cleaning agents can damage the lens cover.

11.2 Servicing

The device does not normally require any maintenance by the operator.

Repairs to the device must only be carried out by the manufacturer.

- ↳ For repairs, contact your responsible Leuze electronic subsidiary or Leuze electronic customer service (see chapter 12 "Service and support").

11.3 Disposing

- ↳ For disposal observe the applicable national regulations regarding electronic components.

12 Service and support

24-hour on-call service at:

+49 (0) 7021 573 - 0

Service hotline:

+49 (0) 7021 573 - 123

Monday to Friday 8.00 a.m. to 5.00 p.m. (UTC+1)

E-mail:

service.identify@leuze.de

Repair service and returns:

Procedure and Internet form can be found at

www.leuze.com/repair

Return address for repairs:

Service center

Leuze electronic GmbH + Co. KG

In der Braike 1

D-73277 Owen / Germany

12.1 What to do should servicing be required?

NOTICE
Please use this chapter as a master copy should servicing be required!
↪ Enter the contact information and fax this form together with your service order to the fax number given below.

Customer data (please complete)

Device type:	
Serial number:	
Firmware:	
Display messages:	
LED states:	
Error description:	
Company:	
Contact person/department:	
Phone (direct):	
Fax:	
Street/No:	
ZIP code/City:	
Country:	

Leuze Service fax number:

+49 7021 573 - 199

13 Technical data

13.1 General specifications

Table 13.1: Optics

Light source	Infrared LED, strobed operation Exempt group (in acc. with EN 62471)
Wavelength	850 nm
Image sensor	Global shutter CMOS
Number of pixels	752 x 480
Focal length	16 mm
Electronic shutter speeds	54 μ s ... 20 μ s
Read distance	From 250 mm (<i>Near Rack</i>) Up to 1900 mm (<i>Far Rack</i>)
Field of view X - Y	From 74 x 48 mm (<i>Near Rack</i> , 250 mm distance) Up to 545 x 348 mm (<i>Far Rack</i> , 1900 mm distance)
Marking size (round)	Diameter 10 mm ... 20 mm <i>Near Rack</i> : minimum marking size 10 mm <i>Far Rack</i> : minimum marking size 13 mm

Table 13.2: Electrical equipment

Operating voltage U_B	18 ... 30 VDC PELV, Class 2 / SELV
Power consumption	8 W maximum
Switching inputs	4 digital switching inputs, protected against polarity reversal 18 ... 30 VDC, depending on supply voltage
Switching outputs	4 digital switching outputs, freely programmable function <ul style="list-style-type: none"> • 18 ... 30 VDC, depending on supply voltage • I_{max}: 60 mA per switching output; 100 mA total current • short-circuit proof, protected against polarity reversal
Process interface	RS 232, Ethernet 10/100 Mbit/s
Service interface	Ethernet 10/100 Mbit/s

Table 13.3: Operating and display elements

Display	Monochromatic graphical display, 128 x 64 pixel, with background lighting
Keyboard	4 control buttons
LEDs	2 LEDs for power (PWR) and bus state (BUS) Green/orange/red

Table 13.4: Mechanical data

Housing	Diecast aluminum
Connection technology	M12 connectors
Degree of protection	IP 65, IP 67 Each with screwed-on M12 connector
Weight	500 g
Dimensions	(H x W x D) 113 mm x 75 mm x 55 mm
Lens cover	Glass

Table 13.5: Environmental data

Ambient temperature (operation)	0 °C ... +45 °C
Temperature range (storage)	-20 °C ... +70 °C
Air humidity	Maximum 90 % rel. humidity, non-condensing
Vibration	IEC 60068-2-6, test Fc
Shock Continuous shock	IEC 60068-2-27, test Ea IEC 60068-2-29, test Eb
Electromagnetic compatibility	EN 61000-6-2, EN 61000-6-4

Device with heating

Table 13.6: Electrical equipment

Operating voltage U_B	24 VDC \pm 20 % Devices with heating do not have UL approval
Power consumption	20 W maximum
Structure of the heating	Housing heating and separate heating of the optics glass
Warmup time	Minimum 30 min at +24 VDC and an ambient temperature of -35 °C
Minimum conductor cross section	Conductor cross section of at least 0.75 mm ² for the supply voltage supply line. Notice: Wiring through of the voltage supply to multiple heating devices is not permissible. Standard, M12 ready-made cable not usable (insufficient conductor cross section).

Table 13.7: Ambient temperature

Ambient temperature (operation)	-35 °C ... +45 °C
Temperature range (storage)	-20 °C ... +70 °C

13.2 Dimensioned drawings

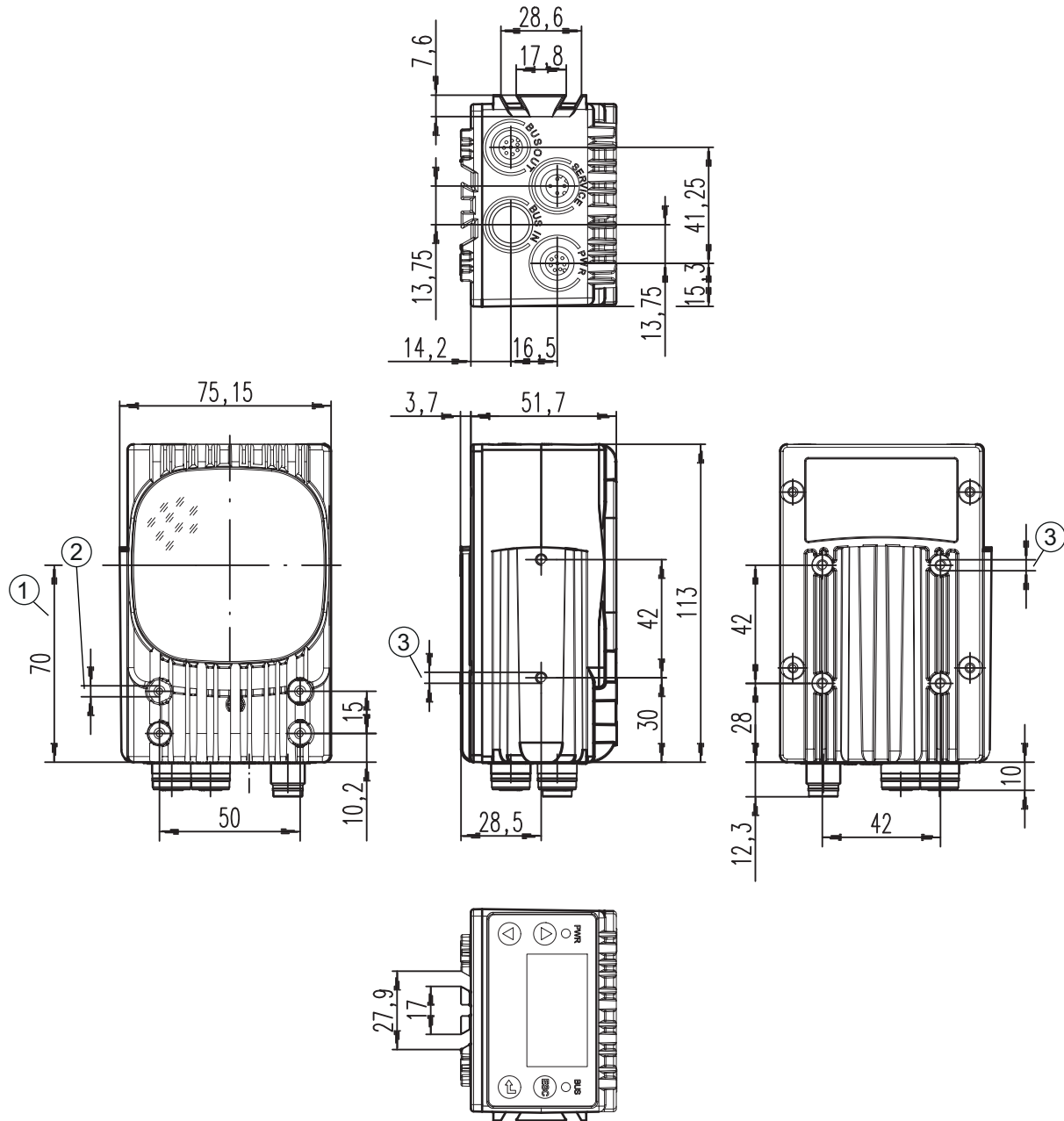

all dimensions in mm

Figure 13.1: Dimensioned drawing LSIS 472i

14 Ordering information and accessories

14.1 Type overview LSIS 472i

Table 14.1: Type overview LSIS 472i

Part no.	Part designation	Description
50128424	LSIS 472i M45-I1	Smart camera for compartment fine positioning
50128425	LSIS 472i M45-I1-H	Smart camera for compartment fine positioning with heating

14.2 Cables-Accessories

Table 14.2:

Part no.	Part designation	Description
PWR-IO connection cable, axial M12 socket, 8-pin, A-coded, open cable end		
50110171	KB M12/8-2000-BA	PWR-IO connection cable, cable length 2 m
50110172	KB M12/8-5000-BA	PWR-IO connection cable, cable length 5 m
50110173	KB M12/8-10000-BA	PWR-IO connection cable, cable length 10 m
50110177	KB M12/8-30000-BA	PWR-IO connection cable, cable length 30 m
IO-DATA connection cable, axial M12 plug, 8-pin, A-coded, open cable end Shielded for line lengths up to and including 10 m; longer lengths unshielded		
50110179	KB M12/8-2000-SA	IO-DATA connection cable, cable length 2 m
50110180	KB M12/8-5000-SA	IO-DATA connection cable, cable length 5 m
50110181	KB M12/8-10000-SA	IO-DATA connection cable, cable length 10 m
50110189	KB M12/8-30000-SA	IO-DATA connection cable, cable length 30 m
Ethernet connection cable, axial M12 plug, 4-pin, D-coded, open cable end		
50106739	KB ET-2000-SA	Ethernet connection cable, cable length 2 m
50106740	KB ET-5000-SA	Ethernet connection cable, cable length 5 m
50106741	KB ET-10000-SA	Ethernet connection cable, cable length 10 m
50106746	KB ET-30000-SA	Ethernet connection cable, cable length 30 m
50113468	KB JST-M12A-8P-Y-3000	Interconnection cable for LSIS 472i to MA 2xxi, axial M12 socket, 8-pin, A-coded, cable length 3 m

14.3 Other accessories

Table 14.3:

Part no.	Part designation	Description
Modular connection units		
50112891	MA 248i	Modular fieldbus connection for field use; interfaces: RS 232 / PROFINET IO
50112892	MA 208i	Modular fieldbus connection for field use; interfaces: RS 232 / Ethernet TCP/IP
50112893	MA 204i	Modular fieldbus connection for field use; interfaces: RS 232 / PROFIBUS DP
50114154	MA 235i	Modular fieldbus connection for field use; interfaces: RS 232 / CANopen
50114155	MA 238i	Modular fieldbus connection for field use; interfaces: RS 232 / EtherCAT
50114156	MA 255i	Modular fieldbus connection for field use; interfaces: RS 232 / DeviceNet
50114157	MA 258i	Modular fieldbus connection for field use; interfaces: RS 232 / EtherNet/IP
Reflectors		
50129309	MTKZ 15-30	Reflector, 1 piece
50129092	MTKZ 15-30 SET	Reflector set with 100 pieces

Table 14.4: Mounting device accessories

Part no.	Part designation	Description
50027375	BT 56	Mounting device for rod
50111224	BT 59	Mounting device for ITEM aluminum profile

15 EC Declaration of Conformity

The LSIS 472i smart camera was developed and manufactured in accordance with the applicable European standards and directives.

The manufacturer of the product, **Leuze electronic GmbH + Co. KG** in D-73277 Owen, possesses a certified quality assurance system in accordance with ISO 9001.

