

Original operating instructions

ODS 9

Laser distance sensor



© 2020

Leuze electronic GmbH + Co. KG

1	About this document	6
1.1	Used symbols and signal words	6
1.2	Important terms.....	8
2	Safety	9
2.1	Intended use	9
2.2	Foreseeable misuse	9
2.3	Competent persons	10
2.4	Disclaimer	10
2.5	Laser safety notices.....	11
3	Device description	14
3.1	Device overview.....	14
3.1.1	General information	14
3.1.2	Operating principle	15
3.1.3	Performance characteristics.....	15
3.1.4	Accessories	15
3.2	Connection technology	16
3.3	Indicators and operational controls.....	16
3.3.1	LED indicators	16
3.3.2	Control buttons	16
3.3.3	Display.....	17
3.3.4	Meaning of the display icons.....	19
3.4	Configuration / menu structure	19
3.4.1	Input menu	20
3.4.2	Output_SSC1 menu	20
3.4.3	Output_SSC2 menu	21
3.4.4	Analog_Output menu	23
3.4.5	Serial Menu	23
3.4.6	Application menu.....	25
3.4.7	Settings menu	30
3.4.8	Ending configuration.....	31
3.5	Configuration example.....	31
4	Applications	34
4.1	Wood width measurement.....	34
4.2	Assembly inspection	35
5	Mounting.....	36
5.1	Mounting with mounting system	36
6	Electrical connection.....	37
6.1	Overview.....	37
6.2	Pin assignment	37
7	Starting up the device	40
7.1	Teaching and configuring output functions	40
7.1.1	Setting the analog output	40
7.1.2	Setting the switching outputs.....	41
7.1.3	Teach-in / teach.....	46
7.1.4	Teaching the output functions via the multifunction input.....	46
7.1.5	Teaching the output functions via the IO-Link system commands	48
7.2	Setting measurement value processing and filtering	50
7.3	Reset to factory settings	50



7.4	IO-Link interface	50
7.4.1	Overview	50
7.4.2	IO-Link process data	52
7.5	Serial interface	53
7.5.1	Measurement value output for various transmission types	53
7.5.2	Commands for remote control operation	55
7.5.3	Termination of data lines	57
7.5.4	Operation on the fieldbus and Ethernet.....	58
8	Connecting to a PC – Sensor Studio	59
8.1	System requirements	60
8.2	Installing Sensor Studio configuration software and IO-Link USB master	60
8.2.1	Downloading configuration software	60
8.2.2	Installing the Sensor Studio FDT frame	61
8.2.3	Installing drivers for IO-Link USB master	61
8.2.4	Connecting IO-Link USB master to the PC	62
8.2.5	Connecting IO-Link USB master to the sensor	62
8.2.6	Installing the DTM and IODD	63
8.2.7	Importing device descriptions	63
8.3	Starting the Sensor Studio configuration software.....	63
8.4	Short description of the Sensor Studio configuration software	65
8.4.1	FDT frame menu	66
8.4.2	IDENTIFICATION function	66
8.4.3	CONFIGURATION function.....	67
8.4.4	PROCESS function	69
8.4.5	DIAGNOSIS function.....	71
8.4.6	Exiting Sensor Studio	71
9	Troubleshooting.....	72
9.1	What to do in case of failure?	72
9.2	LED indicators	72
9.3	Indicators in the display	72
10	Care, maintenance and disposal	73
10.1	Cleaning.....	73
10.2	Servicing	73
10.3	Disposing	73
11	Service and support	74
11.1	What to do should servicing be required?	74
12	Technical data	75
12.1	Measurement data	75
12.2	Optical data.....	77
12.3	Indicators and operational controls.....	78
12.4	Electrical data	78
12.5	Mechanical data.....	78
12.6	Environmental data	79
12.7	Dimensioned drawings	80
12.8	Dimensioned drawings: Accessories	81
13	Order guide and accessories.....	82
13.1	Type overview ODS 9	82
13.2	Accessories – cables and connectors	83

13.3	Other accessories	84
13.3.1	Accessories – PC connection.....	84
13.3.2	Accessories – IO-Link master	84
14	EC Declaration of Conformity	85



1 About this document

1.1 Used symbols and signal words

Tab. 1.1: Warning symbols and signal words

	Symbol indicating dangers to persons
	Symbol indicating dangers from harmful laser radiation
NOTE	Signal word for property damage Indicates dangers that may result in property damage if the measures for danger avoidance are not followed.
CAUTION	Signal word for minor injuries Indicates dangers that may result in minor injury if the measures for danger avoidance are not followed.

Tab. 1.2: Other symbols

	Symbol for tips Text passages with this symbol provide you with further information.
	Symbol for action steps Text passages with this symbol instruct you to perform actions.

Tab. 1.3: Terms and abbreviations

BG	Background Mode in which switching outputs react/switch when an object enters a set distance
DS	Data Storage Data memory of the connected IO-Link master
DSUpload	Data Storage Upload Upload to the data memory of the connected IO-Link master
DTM	Device Type Manager Software device manager of the sensor
FDT	Field Device Tool Software frame for management of device managers (DTM)
FE	Functional earth
IODD	IO Device Description File with information on process data and device parameters
Max. Min.	Maximum Minimum
NEC	National Electric Code
ODS	Optical Distance Sensor Optical distance sensor
OLED	Organic Light Emitting Diode Organic LED
PELV	Protective Extra Low Voltage Protective extra low voltage with reliable disconnection
Pt	Point Switching point
SIO	Standard IO mode Signal transfer without IO-Link
SP	Setpoint Position at which the switching point is set
SSC	Switching Signal Channel Abbreviation for the switching outputs acc. to Smart Sensor Profile
SSP	Smart Sensor Profile Profile acc. to IO-Link standard
UL	Underwriters Laboratories

1.2 Important terms

Tab. 1.4: Important terms

Response time (Response time)	<p>Also integration time or measurement time. Maximum length of time from the occurrence of an erratic change in distance to the steady state of the measurement value.</p> <p>The response time depends on the set average calculation. Although the average calculation increases the response time, it also improves reproducibility.</p>
Resolution	Smallest representable change in measurement value, distance and speed.
Warmup time	<p>Time the sensor needs in order to reach the operating temperature. An optimal measurement is only possible after the end of the warmup time.</p> <p>The warmup time is approximately 20 minutes.</p>
Output resolution	<p>The output resolution describes how the measurement values are presented on the display and digital interfaces.</p> <p>Depending on the device model, the output resolution of the ODS 9 is 0.01 mm or 0.1 mm and cannot be changed.</p>
Output time (Output time)	Time interval of measurement value updating at the interface.
Readiness delay	The delay before start-up indicates the point in time when the first valid measurement can be obtained after switching on.
Data storage IO-Link data storage	Data memory of the connected IO-Link master.
DSUpload	<p>Data Storage Upload.</p> <p>Upload to the data memory of the connected IO-Link master.</p>
Accuracy	Maximum expected deviation of the measurement value between the determined and real distance value within the specified measurement range.
Light switching Dark switching	<p>The behavior of the switching output if an object is within the taught/configured switching distance.</p> <ul style="list-style-type: none"> • Light switching: switching output active (high) • Dark switching: switching output not active (low)
Diffuse reflection	<p>Return and/or degree of reflection of the radiated light. Observe the specifications regarding diffuse reflection (see chapter 12 "Technical data").</p> <ul style="list-style-type: none"> • 90 % is white • 6 % is black
Reproducibility	<p>Also repeatability. Deviation of multiple measurement results relative to each other under identical conditions. Dependent on the measurement distance and the diffuse reflection of the measurement object.</p> <p>The reproducibility can be considered as the measure of measurement value noise and is affected by the configuration of the response time.</p>
Triangulation measurement principle	Distance measuring procedure, which determines the distance of an object by the incidence angle of the light reflected from the object.

2 Safety

This sensor was developed, manufactured and tested in line with the applicable safety standards. It corresponds to the state of the art.

2.1 Intended use

The device is designed as an optoelectronic sensor for the optical, contactless measurement of the distance to objects.

Areas of application

The laser distance sensor is designed for the following areas of application:

- Distance measurement
- Thickness measurement
- Positioning
- Diameter determination
- Fill level indicator

 **CAUTION**

	<p>Observe intended use!</p> <p>The protection of personnel and the device cannot be guaranteed if the device is operated in a manner not complying with its intended use.</p> <ul style="list-style-type: none"> ↳ Only operate the device in accordance with its intended use. ↳ Leuze electronic GmbH + Co. KG is not liable for damages caused by improper use. ↳ Read these operating instructions before commissioning the device. Knowledge of the operating instructions is an element of proper use.
---	---

 **CAUTION**

	<p>UL applications!</p> <p>For UL applications, use is only permitted in Class 2 circuits in accordance with the NEC (National Electric Code).</p>
---	---

NOTICE

	<p>Comply with conditions and regulations!</p> <ul style="list-style-type: none"> ↳ Observe the locally applicable legal regulations and the rules of the employer's liability insurance association.
---	---

2.2 Foreseeable misuse

Any use other than that defined under "Intended use" or which goes beyond that use is considered improper use.

In particular, use of the device is not permitted in the following cases:

- in rooms with explosive atmospheres
- in circuits which are relevant to safety
- for medical purposes

NOTICE

	<p>Do not modify or otherwise interfere with the device!</p> <ul style="list-style-type: none"> ↳ Do not carry out modifications or otherwise interfere with the device. The device must not be tampered with and must not be changed in any way. ↳ The device must not be opened. There are no user-serviceable parts inside. ↳ Repairs must only be performed by Leuze electronic GmbH + Co. KG.
---	--

2.3 Competent persons

Connection, mounting, commissioning and adjustment of the device must only be carried out by competent persons.

Prerequisites for competent persons:

- They have a suitable technical education.
- They are familiar with the rules and regulations for occupational safety and safety at work.
- They are familiar with the original operating instructions of the device.
- They have been instructed by the responsible person on the mounting and operation of the device.

Certified electricians

Electrical work must be carried out by a certified electrician.

Due to their technical training, knowledge and experience as well as their familiarity with relevant standards and regulations, certified electricians are able to perform work on electrical systems and independently detect possible dangers.

In Germany, certified electricians must fulfill the requirements of accident-prevention regulations DGUV (German Social Accident Insurance) provision 3 (e.g. electrician foreman). In other countries, there are respective regulations that must be observed.



2.4 Disclaimer

Leuze electronic GmbH + Co. KG is not liable in the following cases:



- The device is not being used properly.
- Reasonably foreseeable misuse is not taken into account.
- Mounting and electrical connection are not properly performed.
- Changes (e.g., constructional) are made to the device.

2.5 Laser safety notices

Laser class 1 (ODS9L1...)

 ATTENTION	
	<p>LASER RADIATION – CLASS 1 LASER PRODUCT</p> <p>The device satisfies the requirements of IEC/EN 60825-1:2014 safety regulations for a product of laser class 1 and complies with 21 CFR 1040.10 except for conformance with IEC 60825-1 Ed. 3., as described in Laser Notice No. 56, dated May 8, 2019.</p> <ul style="list-style-type: none"> ↪ Observe the applicable statutory and local laser protection regulations. ↪ The device must not be tampered with and must not be changed in any way. There are no user-serviceable parts inside the device. Repairs must only be performed by Leuze electronic GmbH + Co. KG.

Laser class 2 (ODS9L2...)

 ATTENTION	
	<p>LASER RADIATION – CLASS 2 LASER PRODUCT</p> <p>Do not stare into beam!</p> <p>The device satisfies the requirements of IEC/EN 60825-1:2014 safety regulations for a product of laser class 2 and complies with 21 CFR 1040.10 except for conformance with IEC 60825-1 Ed. 3., as described in Laser Notice No. 56, dated May 8, 2019.</p> <ul style="list-style-type: none"> ↪ Never look directly into the laser beam, the laser aperture (1) or in the direction of reflected laser beams! If you look into the beam path over a longer time period, there is a risk of injury to the retina. ↪ Do not point the laser beam of the device at persons! ↪ Interrupt the laser beam using a non-transparent, non-reflective object if the laser beam is accidentally directed towards a person. ↪ When mounting and aligning the device, avoid reflections of the laser beam off reflective surfaces! ↪ CAUTION! Use of controls or adjustments or performance of procedures other than specified herein may result in hazardous light exposure. ↪ Observe the applicable statutory and local laser protection regulations. ↪ The device must not be tampered with and must not be changed in any way. There are no user-serviceable parts inside the device. ↪ Repairs must only be performed by Leuze electronic GmbH + Co. KG. ↪ The laser radiation emitted from the sensor is collimated. The laser is operated in pulse mode. Pulse power, pulse duration and wavelength see chapter 12 "Technical data".

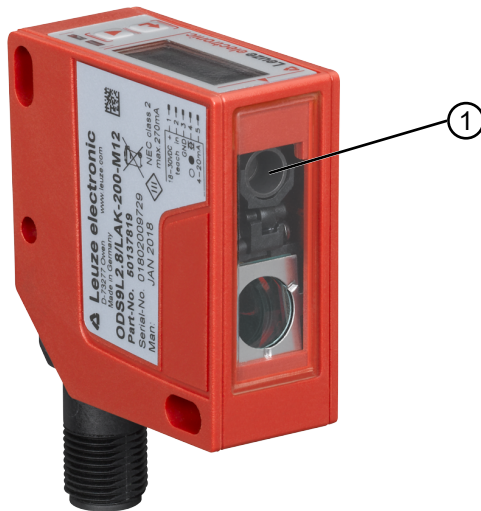

Fig. 2.1: Laser aperture

NOTICE



Affix laser information and warning signs!

Laser information and warning signs attached to the device. Also included with the device are self-adhesive laser warning and laser information signs (stick-on labels) in multiple languages.

- ↪ Affix the laser information sheet to the device in the language appropriate for the place of use.
When using the device in the US, use the stick-on label with the "Complies with 21 CFR 1040.10" notice.
- ↪ Affix the laser information and warning signs near the device if no signs are attached to the device (e.g. because the device is too small) or if the attached laser information and warning signs are concealed due to the installation position.
Affix the laser information and warning signs so that they are legible without exposing the reader to the laser radiation of the device or other optical radiation.



Fig. 2.2: Laser information and warning signs

3 Device description

3.1 Device overview

3.1.1 General information

The laser distance sensor is an optical distance sensor that operates according to the triangulation measurement principle.

The sensor consists of the following components:

- Transmitter: laser spot
- Receiver
- White OLED display
- Control panel with control buttons
- Status LEDs
- Connection for connecting to the control: M12 connector

The sensor can be configured using display and control buttons.

With the *Sensor Studio* configuration software, the sensors can be configured via the IO-Link interface with a PC and the measurement values visualized. Stored parameter sets can be duplicated in other sensors. The connection is made via the IO-Link USB master, which is available as an accessory.

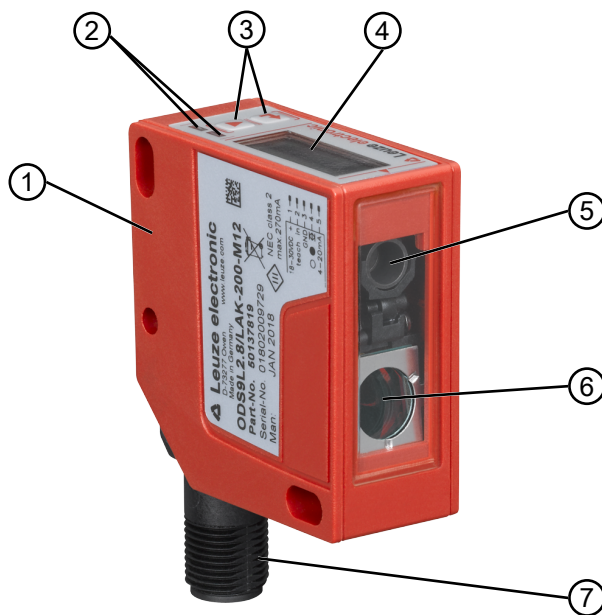

- 1 Device housing
- 2 Status LEDs
- 3 Control buttons
- 4 Display
- 5 Transmitter
- 6 Receiver
- 7 Connection

Fig. 3.1: Device construction

3.1.2 Operating principle

Triangulation measurement principle

Distance measuring procedure, which determines the distance of an object by the incidence angle of the light reflected from the object.

Advantages of the triangulation measurement principle:

- Short response times and, thus, high measurement rates
- High accuracy

3.1.3 Performance characteristics

The most important performance characteristic of the ODS 9 laser distance sensor:

- Measurement ranges:
 - 50 mm ... 650 mm against objects (6 ... 9% diffuse reflection)
- Analog current and voltage output (configurable)
 - Factory setting: current output
- OLED display and control buttons for configuration
- Configurable measurement range and measure mode
- Measurement value display in mm on OLED display
- IO-Link version 1.1
 - Compliant with the "Smart Sensor Profile" specification
 - Dual Channel: the IO-Link interface can be used in parallel with the other output functions.
- Communication interface RS 232/RS 485, depending on the device type
- Optional: multifunction input for deactivating the laser or for teaching the digital switching points (teach-in)
 - Factory setting: input for deactivating the laser
- Optional: second switching output if the IO-Link interface is not used

For measurement against objects:

- Measurement range: 50 mm ... max. 650 mm, dependent on device type
- Measurement against diffusely reflective objects
- Reflection-independent distance information
- Applications:
 - Distance measurement
 - Contour determination
 - Thickness measurement
 - Positioning
 - Diameter determination
 - Sag determination
 - Stack height measurement
 - Loop measurement

3.1.4 Accessories

Special accessories are available for the laser distance sensor (see chapter 13 "Order guide and accessories"):

- Mounting systems for mounting on rods
- Connection cables
- IO-Link USB master set for connecting to a PC
- IO-Link master for cascading or integrating in a higher-level network

3.2 Connection technology

For the electrical connection of the laser distance sensor, the following connection variants are available:

- M12 connector, 5-pin, turns 180°

3.3 Indicators and operational controls

The device housing is provided with the following indicators and operational controls:

- OLED display
- Two control buttons
- Green LED: operating state (PWR)
- Orange LED: switching output information (SSC)

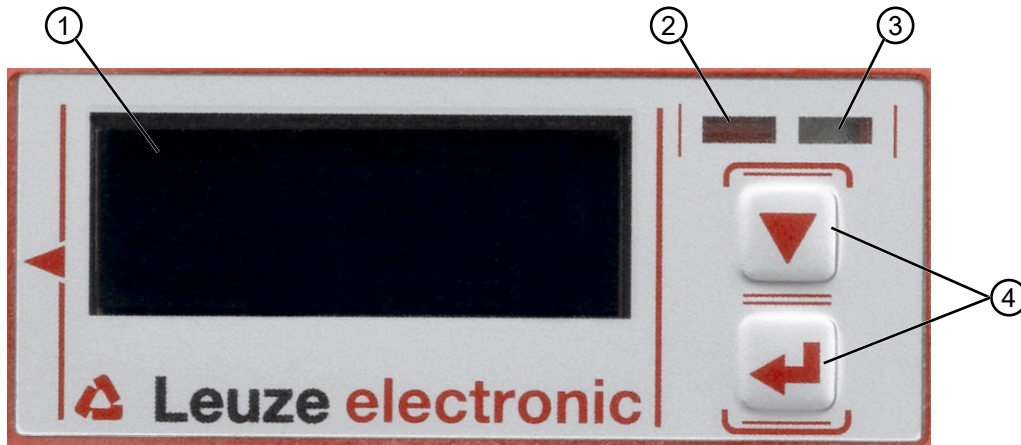

- 1 Display
- 2 Orange LED (SSC1/SSC2)
- 3 Green LED (PWR)
- 4 Control buttons

Fig. 3.2: Indicators and operational controls

3.3.1 LED indicators

Tab. 3.1: Meaning of the LED indicators on the device housing

LED	Color, state	Description
Green LED PWR	Green	Sensor ready
	Off	No supply voltage
Orange LED Switching output SSC1/ SSC2	On	Object detected in the switching range
	Off	No object detected in the switching range

3.3.2 Control buttons

The sensor can be configured using display and control buttons. The display is controlled via the control buttons. You can make adjustments in the application via the control buttons.

- ▼ – Scroll through the functions
- ↵ – Enter button: select function, confirm/enter value

The ▼ and ↵ buttons have different functions depending on the operating situation. These functions are displayed via icons at the right edge of the display (see chapter 3.3.4 "Meaning of the display icons").

Navigating within the menus

Use the navigation button ▼ to move through the menu.

Activate the desired selection with the enter button ↵.

The number of bars at the left edge of the display indicates the current menu level.

Selecting options

Set the desired option with the navigation button ▼ and the enter button ↵.

Resetting to factory settings

↵ While switching on the supply voltage, press the enter button ↵ to reset the sensor configuration to the factory settings.

↵ Press the enter button ↵ again to reset all parameters to factory settings. All parameter settings made previously are permanently lost.

Press the navigation button ▼ to return to process mode without resetting the parameters.

NOTICE



You can also use the menu (see chapter 3.4 "Configuration / menu structure") or the *Sensor Studio* configuration software to reset to factory settings (see chapter 8 "Connecting to a PC – Sensor Studio").

3.3.3 Display

The display changes depending on the current operating mode. The following display modes exist:

- Menu display

Press one of the two control buttons once or twice to access the menu display.

For information on operating via the menu, see chapter 3.4 "Configuration / menu structure" and the configuration example (see chapter 3.5 "Configuration example").

- Process mode

After switching on the supply voltage and error-free initialization of the device, the green LED lights up continuously. The laser distance sensor is in process mode.

In process mode, the current measurement value is displayed in the display, e.g. "267 mm".

NOTICE











In the menu display, the selectable or editable values are shown with inverted text colors (black on white background).

If no key is pressed for approx. 6 minutes in the configuration menu, the device automatically returns to the process mode.

The sensor can be protected against unauthorized configuration change by activating the password query (see chapter 3.4.7 "Settings menu"). The password is permanently set to **165**. In addition, a complete button lock can be activated using the lock function (device access locks, bit 2) (see the table "Status displays on the display").







Status displays in process mode

Tab. 3.2: Status displays on the display

	<p>Object distance in mm</p>
	<p>No measurement value available, e.g. due to a weak or missing reception signal. No object detected or reception signal too weak.</p>
	<p>No object detected or reception signal too weak.</p> <ul style="list-style-type: none"> • Out of Range (+) • Out of Range (-) • +max
	<p>Sensor deactivated, laser switched off</p> <ul style="list-style-type: none"> • Via the input function (see chapter 3.4.1 "Input menu") • Via the IO-Link command
	<p>The current measurement value is less than the lower limit value of the analog output distance.</p>
	<p>The current measurement value is greater than the upper limit value of the analog output distance.</p>
	<p>The measurement value has an offset and/or the gradient is falling (-1)</p>
	<p>Lock function: Button lock activated via IO-Link (device access locks, bit 3) The button lock can also be enabled and set using the configuration software <i>Sensor Studio</i>: Configuration > Local operation</p>



3.3.4 Meaning of the display icons

The ▼ and ↵ buttons have different functions depending on the operating situation. These functions are displayed via icons at the right edge of the display.

Icon	Position	Function
	First line	By pressing the navigation button ▼ you select the next parameter within a menu level.
	Second line	Symbolizes the respective, next menu level that you have not yet selected.
	Second line	Press the enter button ↵ to exit the menu level or the menu.
	Second line	Symbolizes the input mode. The selected (highlighted) option field can be a fixed selection parameter or a multi-digit input field. With a multi-digit input field, you can change the active digit cyclically using the navigation button ▼ and switch from one digit to the next using the enter button ↵. Note: If this icon does not appear, the local configuration lock is set via IO-Link (index: 12, bit 2).
	Second line	Confirmation of the selection. This icon appears when you complete an option field with the enter button ↵ and the previously entered value is valid. Pressing the enter button ↵ again saves and displays the change locally.
	Second line	Reject the selection. This icon is accessed from the previous icon (check mark) by pressing the navigation button ▼. Press the enter button ↵ to reject the current value or option parameter.
	Second line	Return to selection. This icon is accessed from the previous icon (cross) by pressing the navigation button ▼. This icon is also accessed if the value newly entered previously is outside the permissible value range, making correction of the entry necessary. Press the enter button ↵ to reset the current value or option parameter and enter a new value or select a new option parameter.

3.4 Configuration / menu structure

The following chapters show the structure of all menu items. For each sensor model, only the actually available menu items are present for entering values or for selecting settings.

NOTICE	
	Use the navigation button ▼ to move through the menu. Activate the desired selection with the enter button ↵.
NOTICE	
	The number of bars at the left edge of the display indicates the current menu level. For information on the meaning of the display icons, see chapter 3.3.4 "Meaning of the display icons".

3.4.1 Input menu

The function of the switching input on pin 5 is set in the **Input** menu.

NOTICE				
 The Input menu is only available for sensors with multifunction input on pin 5 (ODS9.../LAK-...).				
Level 1	Level 2	Level 3	Description	Default
Input	Input_Mode		Function of the switching input on pin 5 if the supply voltage is applied.	
		No_Function	No input function active	
		Teach	Teach analog output and switching output	X
		Deactivation	Switch off laser transmitter with +24 V on the switching input	
		Activation	Switch on laser transmitter with +24 V on the switching input	
		Trigger_Rising	The measurement value is only updated and output by an edge on input PIN 5.	
	Trigger_Falling			
Important: Activation or deactivation using IO-Link commands or process data (PDOOut) only has an effect if neither <i>Deactivation</i> nor <i>Activation</i> is set as the input function.				

3.4.2 Output_SSC1 menu

The switching behavior of switching output SSC1 is set to pin 4 in the **Output_SSC1** menu.

NOTICE	
 Designation "SSC" corresponds to designation "Q" previously used for switching outputs.	

Level 1	Level 2	Level 3	Description	Default
Output_SSC1	SSC1_SP1_(dist.)		Upper switching point	Depending on the device range: <ul style="list-style-type: none"> • 100 mm: 75 mm • 200 mm: 175 mm • 450 mm: 250 mm • 650 mm: 350 mm
	SSC1_SP2_(near)		Lower switching point	50 mm
	Notice: For the limit values of the measurement range for your sensor, see chapter 12 "Technical data".			
	SSC1_Logic		Behavior of the switching output if an object is within the taught/configured switching distance.	
		High_Active	Switching output active (high)	X
		Low_Active	Switching output not active (low)	
	SSC1_Mode		see chapter 7.1.2 "Setting the switching outputs"	
		Single_Point (Obj)	One switching point on the object	X
		Window	Switching window <i>Window</i>	
		Two_Point	Two switching points on the object	
		Single_Point (BG)	One switching point on the back-ground (BG), also referred to as background-teach. Switching process for objects between back-ground and sensor.	
		Deactivated	Mode deactivated	
	SSC1_Hysteresis		Hysteresis	10 mm

3.4.3 Output_SSC2 menu

- ODS9LA6: The switching behavior of switching output SSC2 is set to pin 5 in the **Output_SSC2** menu.
- ODS9L6X: The switching behavior of switching output SSC2 is set to pin 2 in the **Output_SSC2** menu.

NOTICE	
	<ul style="list-style-type: none"> ↪ The Output_SSC2 can only be used for sensors with a second switching output SSC2. ↪ Designation "SSC" corresponds to designation "Q" previously used for switching outputs.

Level 1	Level 2	Level 3	Description	Default
Output_SSC2	SSC2_SP1_(dist)		Upper switching point	Depending on the device range: <ul style="list-style-type: none"> • 100 mm: 75 mm • 200 mm: 175 mm • 450 mm: 250 mm • 650 mm: 350 mm
	SSC2_SP2_(near)		Lower switching point	50 mm
	Notice: For the limit values of the measurement range for your sensor, see chapter 12 "Technical data".			
	SSC2_Logic		Behavior of the switching output if an object is within the taught/configured switching distance.	
		High_Active	Switching output active (high)	X
		Low_Active	Switching output not active (low)	
	SSC2_Mode		see chapter 7.1.2 "Setting the switching outputs"	
		Single_Point (Obj)	One switching point on the object	X
		Window	Switching window <i>Window</i>	
		Two_Point	Two switching points on the object	
		Single_Point (BG)	One switching point on the back-ground (BG), also referred to as background-teach. Switching process for objects between back-ground and sensor.	
		Deactivated	Mode deactivated	
	SSC2_Hysteresis		Hysteresis	10 mm

3.4.4 Analog_Output menu

The characteristic output curve of the analog output is set to pin 2 in the **Analog Output** menu.

NOTICE				
 The Analog Output menu is only available for sensors with analog output.				
Level 1	Level 2	Level 3	Description	Default
Analog out-put	Position_Max.Val.		Distance measurement value for maximum voltage / maximum current	Upper limit of the measurement range
	Position_Min.Val.		Distance measurement value for minimum voltage / minimum current	50 mm
	Notice: For the limit values of the measurement range for your sensor, see chapter 12 "Technical data".			
	Analog Range		Current/voltage range of the analog output	
		4-20_mA		X
	1-10_V			
	0-10_V			

Spreading the characteristic output curve

You can spread the characteristic output curve of the analog output according to your requirements.

- ↪ Select the current or voltage range of the analog output.
- ↪ Set the distance measurement value that corresponds to the lower limit of the measurement range (4 mA, 1 V, 0 V).
- ↪ Set the distance measurement value that corresponds to the upper limit of the measurement range (20 mA, 10 V).

It is also possible to invert the working range of the analog output, i.e., the lower limit of the measurement range is set to a larger value than the upper limit. This creates a descending characteristic output curve.

3.4.5 Serial Menu

In the **Serial** menu, the function of the serial interface is set to pin 2 and pin 5.

NOTICE	
 The Serial is only available for sensors with a serial interface.	

Level 1	Level 2	Level 3	Description	Default	
Serial	Serial_Function		Format of the measurement value output		
		ASCII	Measurement value output corresponding to the device resolution	X	
		14_Bit	2 byte transfer		
		16_Bit	3 byte transfer		
		24_Bit	4 byte transfer		
		Decimal	Transfer of the measurement value as decimal number		
		Remote_Control	Remote control operation of the ODS via remote commands		
		Reserved			
	Note: For the device resolution for your sensor see chapter 12 "Technical data".				
	Device_Address		Address under which the ODS is addressed		
		0 ... 14			1
	Transmiss._Rate		Transmission rate of the serial interface		
		2400_Baud			
		4800_Baud			
		9600_Baud			X
		19200_Baud			
		28800_Baud			
		38400_Baud			
		57600_Baud			
		115200_Baud			
		230400_Baud			
Parity		Transfer of parity bit			
	None			X	
	Odd				
	Even				
Stop_Bit		Number of stop bits			
	1			X	
	2				
Termination_Byte		If not equal to 0, the corresponding character is appended			
	0 ... 255			0	
Transmiss._Delay		Delay of data transmission in milliseconds			
	0 ... 255			0	

3.4.6 Application menu

The measurement function of the sensor is set in the **Application** menu.

Level 1	Level 2	Level 3	Selection level 3	Description	Default
Application	Process_Settings			Measurement value processing	
		Measuram._Mode			
			Standard	Multi-purpose function for many measurement tasks	X
			Precision	Greater accuracy for less dynamic applications	
			Light_Suppression	Ambient light sensitivity	
		LightSuppr.Limit	2 ... 32	Setting of the maximum number of measurements for preventing the sensor from measuring for too long if the light is too bright and, as a result, not outputting a measurement value.	32
	Filter_Settings			Filter for ascertaining and suppressing outliers	
		Filter_Type			
			None		X
			Averaging	Floating average calculation taking 2 ... 99 measurements into account The response time increases with the number of measurements.	
			Spike_Suppression	Blocked central value filtering across buffer sizes from 5 ... 99 measurements	
		Average_Count		Number of measurements used in averaging	10
		Spike_Supp.Count		Number of measurements used in outlier suppression	10
		Spike_Supp.Depth		Adjustable filter depth for outlier suppression	
			Raw	Averages approx. 75 % of the central measurement values	X
			Medium	Averages approx. 50 % of the central measurement values	
			Fine	Averages approx. 25 % of the central measurement values	
	Dist.Correction			Distance calibration	
		Offset			0 mm
		Gradient			
			Rising		X
			Falling		
		Preset_Position			0 mm
		Preset_Calc.			
			Inactive		X
			Execute		

Measurement value processing and filtering is set according to the given requirements and the application via the display or using the *Sensor Studio* configuration software.

By changing the measurement value processing or filtering, the response time and accuracy can be increased.

NOTICE	
	A higher response time presupposes the possibility of measuring an object for a longer period.

Measurement value processing

Processing settings > Measure mode > Standard/Precision/Ambient light

Tab. 3.3: Measurement value processing

	Accuracy	Measurement time / reload	Ambient light	Varying diffuse reflection
Standard	+	+	+	+
Precision	+ +	- -	+	+
Ambient light	+	- -	+ +	0

Filter

Filter settings > Filter type > Averaging/outlier suppression

A floating average value is calculated over the number of set measurement values.

The measurement value noise decreases, i.e., measurement value fluctuations become smaller.

If the measurement value changes erratically, the output value moves linearly from the old measurement value to the new measurement value over n measurements.

The higher the number of measurements is set, the higher the response time of the sensor. With dynamic applications, averaging should be set to a very low number of measurement values or switched off altogether.

The time of measurement value updating is not affected by the filtering.

Outlier suppression

Filter settings > Degree of suppression > Coarse/Medium/Strong

Measurement results with excessively high or low measurement values (referred to as "outliers" or "spikes") are suppressed or rejected according to the set filter depth.

- The user sets the number of measurements via the display or using the configuration software *Sensor Studio*.
- The sensor performs the set number of measurements on the object, e.g. 100 measurements.

Due to physical reasons, the measurement results are not all the same. The measurement values have a scatter which corresponds to a normal distribution comprising a large number of similar measurement values and a small number of excessively high or low measurement values (outliers, spikes).

The suppression or rejection of the measurement value outliers is configured in the following levels using the filter depth:

- Coarse: A large number of measurement values which do not occur with a high frequency are suppressed or rejected.
 - Falling on one side: 12 %
 - Used center area, averaged: 76 %

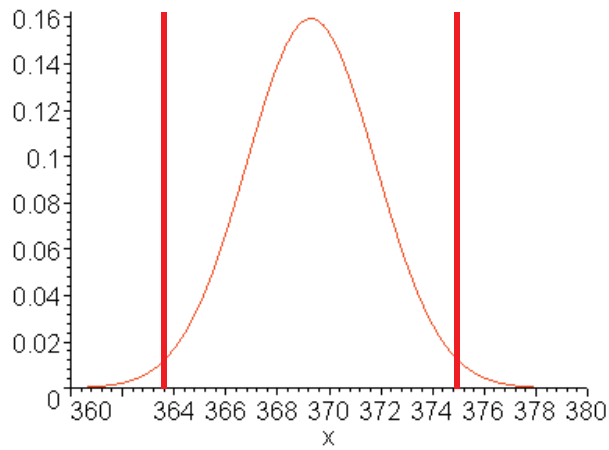

Fig. 3.3: Coarse filter depth

- Medium
 - Falling on one side: 24 %
 - Used center area, averaged: 52 %

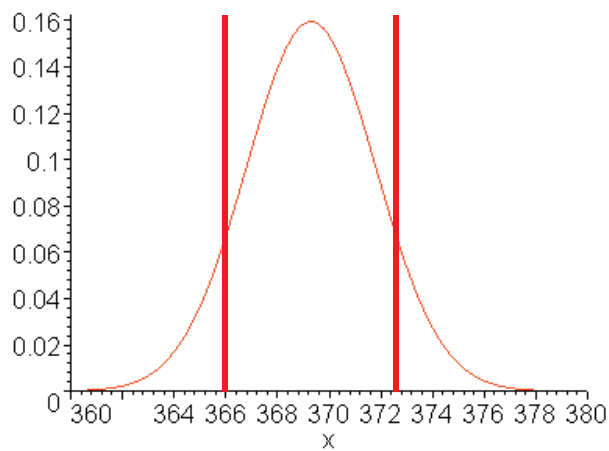

Fig. 3.4: Medium filter depth

- Strong
 - Falling on one side: 36 %
 - Used center area, averaged: 28 %

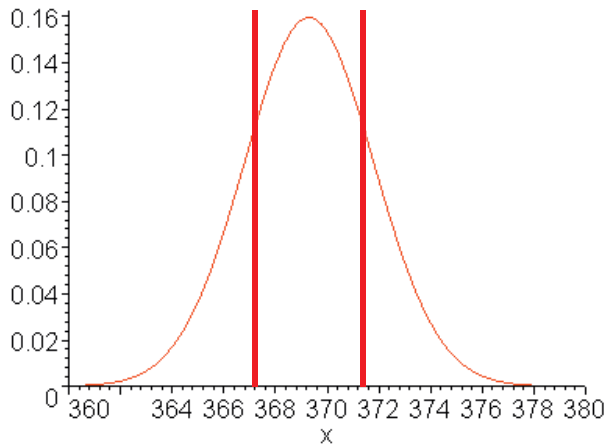



Fig. 3.5: Strong filter depth

NOTICE	
	In the case of dynamic applications with erratic changes in measurement distance, it is recommended to filter by setting the response time.

Distance calibration "Distance correction"

Under the **Distance correction** menu item, you can influence the output of the measured distance value.

Gradient

If the gradient is changed from *rising* to *falling*, the measurement values decrease as the distance from the object to the sensor increases. The distance information is output inverted.

NOTICE	
	Negative measurement values may result if the gradient is reversed.

Offset and Preset

Deviations that arise while mounting and attaching the sensor can be compensated for with the entries for the *Offset* and *Preset* parameters.

NOTICE	
	Negative measurement values may occur if an <i>offset</i> is set.

The *offset/preset* calculation is available as a teach function. The assignment of the teach time frame can be read out via IO-Link (see chapter 7 "Starting up the device").

Specify offset and preset

Under the **Application > Dist.Correction** menu item, you can influence the output of the measured distance value. The *Offset* and *Preset* parameters are used for correcting the measurement value by a fixed amount.

Deviations that arise while mounting and attaching the sensor can be compensated for with the entries for the *Offset* and *Preset* parameters.

- For the *Offset* parameter, a fixed value and sign are specified.
- For the *Preset* parameter, a nominal measurement value is specified; a measurement is then performed using an object located at the desired nominal distance. The *Offset* parameter is changed as a result of this measurement.

NOTICE



If the calculation of the *Offset* parameter results in negative measurement values, zero is output at the interface and on the display.

Setting the offset

↪ Enter an offset value via the display:

Application > Dist.Correction > Offset

⇒ The set offset value is added to the measured distance value of the sensor.

Example:

- Measurement value of the ODS 9: 1,500 mm
- Entry offset-value: -100 mm
- Output on the display and at the interface: 1400 mm

Preset presetting

↪ Enter a Preset value via the display or using the *Sensor Studio* configuration software (**IO-Link**):

Application > Distance correction > Preset position

↪ Position an object at the desired preset distance.

↪ Perform the preset measurement:

Application > Distance correction > Preset calculation > Execute

⇒ The offset value is automatically calculated from the measurement value and nominal measurement value (preset value) and entered as the offset in the configuration.

Example:

- Entry: preset value 350 mm
- Object distance: 300 mm in front of the sensor

Trigger preset measurement

Distance correction > Preset calculation > Execute

An offset of +50 mm is automatically calculated and stored in the configuration.

- Object distance: 300 mm
Output to display and interface: 350 mm
- Object distance: 400 mm
Output to display and interface: 450 mm

3.4.7 Settings menu

You can set the display language and call up information about the sensor in the **Settings** menu.

Level 1	Level 2	Level 3	Description	Default	
Settings	Language		Setting of the display language Note: If the display language is changed, this change only becomes effective when the sensor is restarted.		
		English	Display language English	X	
		Deutsch	Display language German		
	Display		Display settings		
		Auto	After pressing a control button, the display is set to full brightness for approx. one minute. The display is then dimmed slightly for five minutes and then dimmed considerably.	X	
		Auto_Off	The display (measurement value display) is automatically switched off after approx. six minutes.		
		Off	No measurement value display – the display is only active in the menu after pressing a control button.		
		On	The display (measurement value display) is always at full brightness.		
	Factory_Settings		Reset to factory settings		
		Inactive	The sensor is not reset to factory settings.	X	
		Execute	The sensor is reset to factory settings.		
	Password_Lock		Locks access to the menu with the fixed password 165		
		Inactive	Inactive	X	
		Activated	Active		
	Exit_behaviour		Exit the configuration settings		
		Report_to_DS	After making a change in the menu, the change is taken over in the data memory after returning to measurement operation. The <i>DSUpload</i> flag is set. The "Data Storage" (DS) parameter memory is updated.	X	
		Only_lo-cal_changes	The change is only temporary or local on the device or no data memory is used. The <i>DSUpload</i> flag is cleared.		
	Info		Information on the sensor		
		Part_No.	Leuze part number of the sensor		
		Serial_No.	Sensor serial number		
	Firmware_Re-vision	Firmware version			

3.4.8 Ending configuration

With IO-Link data storage, the behavior upon ending the configuration settings can be changed in the following ways in the **Settings** menu.

Tab. 3.4: Settings > Exit behavior

Menu item	Use	Display of the menu item
Report to DS (Report to DS)	Changes in the menu are taken over in the data memory after returning to measurement operation. The <i>DSUpload</i> flag is set.	A change was performed and the data memory updated.
Only local changes (only local changes)	The change is only temporary or local on the device or no data memory is used. The <i>DSUpload</i> flag is cleared.	A change was made only locally on the device.

Central storage of configuration data

If the configuration setting is ended with subsequent adoption of the data in the data memory of a connected IO-Link master, the sensor does not need to be newly configured if a device is changed.

The sensor adopts the configuration from the data memory of the connected IO-Link master, provided that the IO-Link master is capable of doing this and enabled accordingly.

Timeout

If the configuration setting is ended due to a timeout, the previously made changes are always reported by default to the data memory (Data Storage, DS). If an IO-Link master is connected, the changes are transferred to its data memory. The status of the *DSUpload* flag is not changed.



If the *DSUpload* flag is not set and the changes are only stored locally, after reconnection the change is overwritten by the configuration which is stored in the data memory of the connected IO-Link master.

NOTICE	
	If the sensor is not operated via an IO-Link master, these settings do not need to be made.

3.5 Configuration example



To illustrate menu operation, the setting of the lower switching point of switching output SSC1 to 100 mm is explained as an example.

↪ In process mode, press a control button to activate the menu display.



Input	
Output SSC1	

↪ Press the navigation button .

⇒ The display shows "Output SSC1" in the upper menu line.



Output SSC1	
Output	

↪ Press the enter button  to select Output SSC1.

SSC1 SP1 (dist.)	
00250 mm	



↵ Press the navigation button ▼ once.

⇒ The display shows "SSC1 SP2 (near)" in the upper menu line.



SSC1 SP2 (near)	
00050 mm	

↵ Press the enter button ↵ to set the lower switching point.



⇒ The first digit of the switching point value is displayed with inverted colors.

SSC1 SP2 (near)	
0 0050 mm	

↵ Press the enter button ↵ twice until the hundreds digit is inverted.



SSC1 SP2 (near).	
0 0 050 mm	

↵ Press the navigation button ▼ as many times as necessary to set the desired value "1".

SSC1 SP2 (near)	
00 1 50 mm	

↵ Press the enter button ↵ to accept the set value.

↵ Repeat the setting for digit 5 until the complete value "00100" is set.
Press the enter button ↵ to move to the units digit.

SSC1 SP2 (near)	
001 0 0 mm	

After pressing the enter button ↵ again, the  icon appears in the lower right part of the display.



- The  icon indicates that the next time the enter ↵ button is pressed, the set value will be accepted.
- You can change the function of the enter button ↵ by pressing the navigation button ▼ several times. The following icons are displayed in succession:

- : re-edit value
- : reject value



↵ Press the enter button ↵ to accept the set value 00100.

⇒ "SSC1 SP2 (near)" is displayed inverted in the display.



The newly set value "00100 mm", which is stored in non-volatile memory, appears in the display.

SSC1 SP2 (near)	
00100 mm	

↵ Press the navigation button ▼ repeatedly until the ← icon appears in the upper menu line.

←	
SSC1 SP1 (dist.)	

↵ Press the enter button ↵ to access the next-higher menu level.

Output SSC2	
Analog output	

↵ Press the enter button ↵ to exit the menu display and access process mode.

225 mm

Quick exit

If you do not wish to make any further configuration settings, you can exit the menu via Quick exit and return to process mode.

NOTICE	
	The <i>DSUpload</i> upload flag is always set on quick exit. This means that parameter changes are passed on to the connected IO-Link master.

↵ Press and hold down the enter button ↵ for at least 5 s – until the "Exit menu" message appears on the display.

↵ Confirm with the enter button ↵.

4 Applications

The laser distance sensor is designed for the following areas of application:

- Distance measurement
- Thickness measurement
- Positioning
- Diameter determination
- Fill level indicator

4.1 Wood width measurement



Fig. 4.1: Application example: wood width measurement

4.2 Assembly inspection



Fig. 4.2: Application example: assembly inspection

5 Mounting

The sensor can be mounted in the following ways:

- Mount using a mounting system
 - BTU 300M-D10: mounting on rod Ø 10 mm
 - BTU 300M-D12: mounting on rod Ø 12 mm
 - BTU 300M-D14: mounting on rod Ø 14 mm

NOTICE



Observe during mounting!

- ↳ Make certain that the required environmental conditions (humidity, temperature) are maintained.
- ↳ Make certain that the optics cover of the sensor is not soiled, e.g., by leaking fluids, abrasion from boxes or residues from packaging material.
- ↳ When mounting behind a cover: Make certain that the cutout in the cover is at least as large as the lens cover of the sensor. Correct measurement cannot otherwise be ensured.

5.1 Mounting with mounting system





Mounting with a mounting system is intended for rod mounting. For ordering information, see chapter 13.3 "Other accessories".

- ↳ Mount the mounting system on the rod (system-side).
- ↳ Mount the sensor on the mounting system with M4 fastening screws (not included in delivery contents).
Max. tightening torque of the fastening screws: 1.4 Nm

6 Electrical connection

6.1 Overview

The assignment of the electrical connections is dependent on the type of sensor that is used. The type designation of the sensor is specified on the name plate.

 CAUTION	
	<p>Safety notices!</p> <ul style="list-style-type: none"> ↪ Before connecting the device, be sure that the supply voltage agrees with the value printed on the name plate. ↪ Only allow competent persons to perform the electrical connection. ↪ Ensure that the functional earth (FE) is connected correctly. Fault-free operation is only guaranteed if the functional earth is connected properly. ↪ If faults cannot be rectified, take the sensor out of operation. Protect the sensor from accidentally being started.
NOTICE	
	<p>Protective Extra Low Voltage (PELV)</p> <ul style="list-style-type: none"> ↪ The sensor is designed in accordance with protection class III for supply with PELV (protective extra-low voltage with reliable disconnection).
NOTICE	
	<ul style="list-style-type: none"> ↪ For all connections (connection cable, interconnection cable, etc.), use only the cables listed in the accessories (see chapter 13.2 "Accessories – cables and connectors"). ↪ Use shielded cables when using the analog interface. You can thereby prevent interference caused by electromagnetic fields.

6.2 Pin assignment

Pin assignment ODS9L2.8/LAK-...-M12

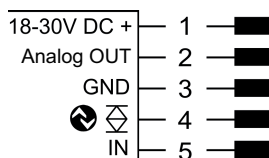



Fig. 6.1: Pin assignment

Pin	Designation	Assignment
1	18-30 V DC +	Supply voltage
2	Analog OUT	Configurable analog output <ul style="list-style-type: none"> • Current: 4 mA ... 20 mA • Voltage: 1 V ... 10 V, 0 V ... 10 V Factory setting: Current
3	GND	Functional earth
4		IO-Link / switching output 1, push-pull
5	IN	Function of the switching input

Pin assignment ODS9L2.8/L6X-...-M12

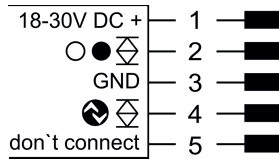



Fig. 6.2: Pin assignment

Pin	Designation	Assignment
1	18-30 V DC +	Supply voltage
2		Switching output 2, push-pull
3	GND	Functional earth
4		IO-Link / switching output 1, push-pull
5	don't connect	don't connect

Pin assignment ODS9L2.8/LA6-...-M12

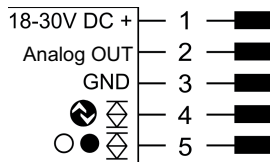



Fig. 6.3: Pin assignment

Pin	Designation	Assignment
1	18-30 V DC +	Supply voltage
2	Analog OUT	Configurable analog output <ul style="list-style-type: none"> • Current: 4 mA ... 20 mA • Voltage: 1 V ... 10 V, 0 V ... 10 V Factory setting: Current
3	GND	Functional earth
4		IO-Link / switching output 1, push-pull
5		Switching output 2, push-pull

Pin assignment ODS9L2.8/LFH-...-M12

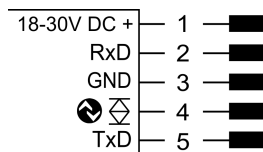



Fig. 6.4: Pin assignment

Pin	Designation	Assignment
1	18-30 V DC +	Supply voltage
2	RxD	Signal RxD of the RS 232 serial interface
3	GND	Functional earth
4		IO-Link / switching output 1, push-pull
5	TxD	Signal TxD of the RS 232 serial interface

Pin assignment ODS9L2.8/LQZ-...-M12

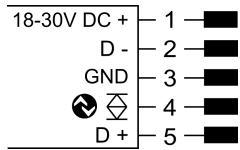

Fig. 6.5: Pin assignment

Pin	Designation	Assignment
1	18-30 V DC +	Supply voltage
2	D –	Signal D – of the RS 485 serial interface
3	GND	Functional earth
4	⚡	Switching output
5	D +	Signal D + of the RS 485 serial interface

7 Starting up the device

7.1 Teaching and configuring output functions

7.1.1 Setting the analog output

The sensors are equipped with an analog output with linear response within the respective measurement range.

Above and below the measurement range linearity is not obtained. If a signal is present, the output values can be used to determine whether the measurement range is exceeded or not met.

In order to achieve the highest resolution possible, set the range of the analog output as small as the application allows. The characteristic output curve can be configured as rising or falling, e.g. for fill level applications.

The output can be switched to current or voltage with the following ranges:

- 4 ... 20 mA
- 1 ... 10 V
- 0 ... 10 V

To configure the analog output, the two distance values *Position Min. Val.* and *Position Max. Val.* are specified at which the respective minimum or maximum analog value is output.

Measurement range **C** is assigned ex works (see figure), e.g., 50 ... 100 mm for device types -100.

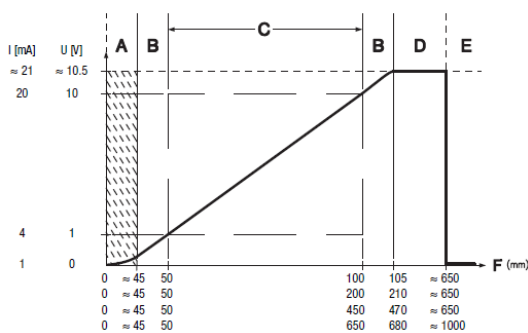

- A Area not defined
- B Linearity not defined
- C Measurement range
- D Object present
- E No object detected (characteristic curve behavior configurable via IO-Link)
- F Measurement distance

Fig. 7.1: Characteristic curve of analog output ODS9L2.8/LA...-M12

Setting the analog output

You can set the characteristic output curve for the analog output as follows:

- Directly changing the parameters:
 - On the device via the OLED display and the control buttons (see chapter 3.4 "Configuration / menu structure")
 - Via the *Sensor Studio* configuration software (see chapter 8 "Connecting to a PC – Sensor Studio").
- Teach-in / teach:
 - Via IO-Link (see chapter 7.1.5 "Teaching the output functions via the IO-Link system commands"), especially using the *Sensor Studio* configuration software (see chapter 8 "Connecting to a PC – Sensor Studio").
 - Via the multifunction input with set *Teach* input function (see chapter 7.1.4 "Teaching the output functions via the multifunction input").

7.1.2 Setting the switching outputs

All sensors are equipped with at least one SSC1 switching output. LA6 model sensors are provided with a second SSC2 switching output.

For each switching output you can configure the following parameters:

- Upper and lower switching point
- Switching hysteresis
- Switching logic
 - Light switching (high active)
 - Dark switching (low active)
- Switching point mode

NOTICE	
	<p>The output state in the hysteresis area is not uniquely defined!</p> <p>The output state in the hysteresis area is dependent on the previous situation.</p> <p>If the output in the hysteresis area is permanently set to <i>high active</i>, a short detection failure (no signal, e.g., due to a target that is marginally dark) results in a change to permanently <i>low active</i> (dark switching).</p>

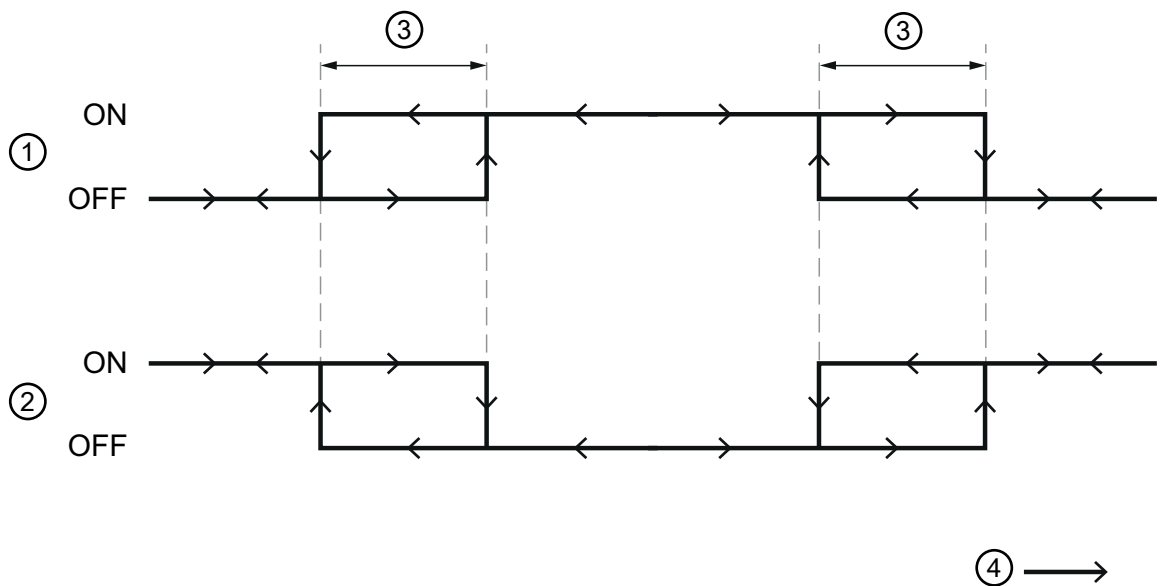

- 1 Light switching
- 2 Dark switching
- 3 Hysteresis
- 4 Measurement distance

Fig. 7.2: Switching output configuration

The switching outputs can be set via the OLED display and the control buttons (see chapter 3.5 "Configuration example"), but also via the multifunction input on pin 5 and via IO-Link system commands.

NOTICE	
	<p>For sensor models with multifunction input, there is only one physically present switching output that can be taught in.</p>

Configuring switching point modes

The following switching point modes can also be configured. These are structured according to the switching profiles of the *Smart Sensor Profile* specification.

- SinglePoint Object mode (SinglePt Obj): single switching point taught on an object
- Window: window mode
- TwoPoint: two-point mode
- SinglePoint Background mode (SinglePt BG): single switching point taught against a background

SinglePoint Object mode (SinglePt Obj)

When teaching setpoint SP1 before or after, the object (Obj) is targeted, i.e., with SP1, the SSC is still active. The SSC becomes inactive only after SP1.

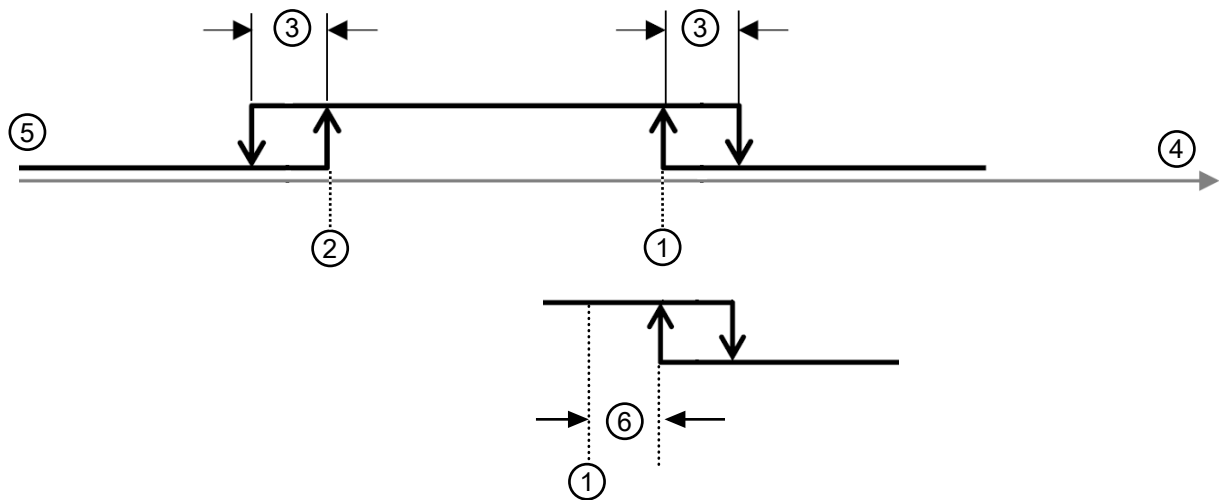

- | | |
|---|---------------------------|
| 1 | Setpoint SP1 |
| 2 | Measurement range minimum |
| 3 | Hysteresis |
| 4 | Signal response |
| 5 | Sensor/SSC |
| 6 | Reserve if >0 |

Fig. 7.3: SinglePoint Object switching point mode

- Only setpoint SP1 (not SP2) is used for calculating the switching edges. The lower switching edges are always at the lower limit value.
- Reserve and hysteresis run from the upper switching point into the distance, so that the switching output has reliably (i.e., with reserve) switched on after the teach event (provided it is light switching *high active*).

Window – window mode

Teach point is midway between the equidistantly shifted setpoints S2 (near) and SP1 (far)

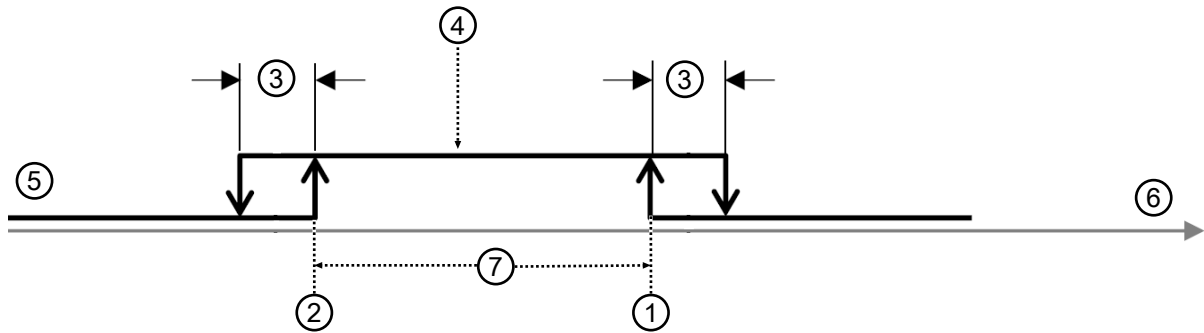

- | | |
|---|---------------------|
| 1 | Setpoint SP1 (far) |
| 2 | Setpoint SP2 (near) |
| 3 | Hysteresis |
| 4 | Teach point |
| 5 | Sensor/SSC |
| 6 | Signal response |
| 7 | Window |

Fig. 7.4: Switching point mode window

- Hysteresis runs to the outside.
- Reserve is not used.

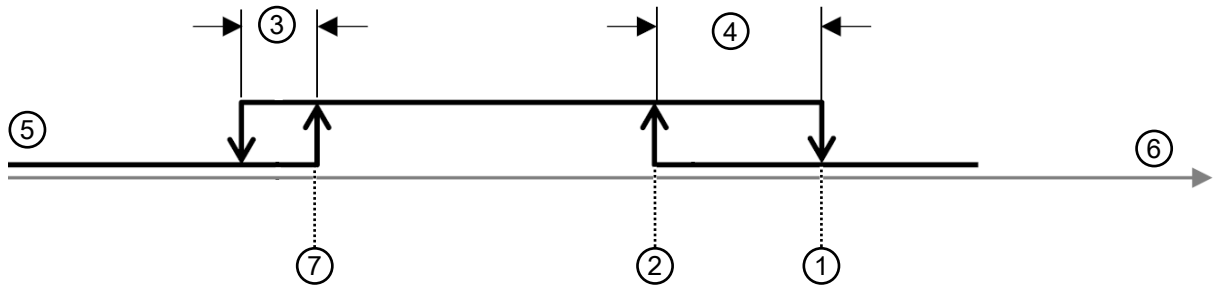

TwoPoint – two-point mode

- Closer than setpoint SP2, the output is set to *high active* (as with the Single Point modes).
- The "far" hysteresis area lies between setpoint SP2 and setpoint SP1; the *Hysteresis* parameter is not used here.
- After setpoint SP1, the output is set to *low active*.



- 1 Setpoint SP1
- 2 Setpoint SP2
- 3 Hysteresis "near"
- 4 Hysteresis "far"
- 5 Sensor/SSC
- 6 Signal response
- 7 Measurement range minimum

Fig. 7.5: TwoPoint switching point mode

NOTICE	
	<p>The <i>Hysteresis</i> parameter is used for the switch-on/switch-off edges at the start of the measurement range.</p> <ul style="list-style-type: none"> ↳ If setpoint SP2 is too close to the switch-on edge, the assigned switching edge is shifted into the distance by the distance of the <i>Hysteresis</i> parameter. ↳ If, afterwards, setpoint SP1 is closer than the shifted edge, the edge assigned to setpoint SP1 is placed on the shifted SP2 edge. The two far switching edges then decrease together.
NOTICE	
	<p>The output state in the hysteresis area is not uniquely defined!</p> <p>The output state in the hysteresis area is dependent on the previous situation.</p> <p>If the output in the hysteresis area is permanently set to <i>high active</i>, a short detection failure (no signal, e.g., due to a target that is marginally dark) results in a change to permanently <i>low active</i> (dark switching).</p>

SinglePoint Background mode (SinglePt BG)

When teaching setpoint SP1 before of after, the background (BG) is targeted, i.e., with setpoint SP1, the SSC must no longer be active. The SSC is only active before setpoint SP1.

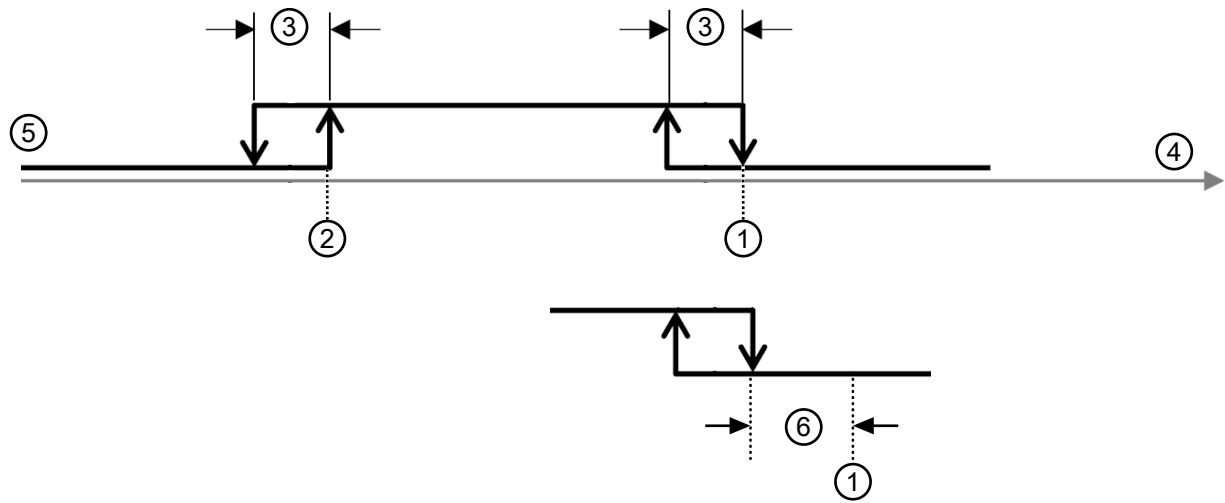

- 1 Setpoint SP1
- 2 Measurement range minimum
- 3 Hysteresis
- 4 Signal response
- 5 Sensor/SSC
- 6 Reserve if >0

Fig. 7.6: SinglePoint BG switching point mode

- Only setpoint SP1 (not SP2) is used for calculating the switching edges. The lower switching edges are always at the lower limit value.
- Reserve and hysteresis run from the upper switching point into the near range, so that the switching output has reliably (i.e., with reserve) switched off after the teach event (provided it is light switching *high active*).

7.1.3 Teach-in / teach

Teaching offers the possibility to adjust certain parameters based on the current measurement situation. Focus here is primarily on settings that affect the output functions, i.e., analog output and the switching output(s).

The teaching action is triggered in the following ways:

- Via the multifunction input when setting the input function to *Teach* (see chapter 7.1.4 "Teaching the output functions via the multifunction input")
- Via IO-Link system commands (see chapter 7.1.5 "Teaching the output functions via the IO-Link system commands")
- Special teach via the device menu (OLED display and control buttons)

When completed, each successful teach returns a so-called teach point (TP), which is formed by averaging multiple individual measurements.

- Prerequisite for successfully teaching is a minimum number of valid measurement values. Objects that are marginally dark and/or distant objects can increase the teach time.
- The teachable areas are limited by model.
- A teach point may only be located within the measurement range described in the table in order for an assignment to the respective, likewise limited parameters to be possible.

Device	Outside of the operating range (-) (Out of Range (-))	Operating range [mm] (measurement value shown on the display)				Outside of the operating range (+) (Out of Range(+))
		Limited accuracy	Measuring range		Limited accuracy	
...-100-...	Directly underneath	47.00	50.00	100.00	110.00	Directly above
...-200-...		47.00	50.00	200.00	220.00	
...-450-...		47.0	50.0	450.0	500.00	
...-650-...		47.0	50.0	650.0	700.00	

7.1.4 Teaching the output functions via the multifunction input

NOTICE	
	The information in this chapter only applies for devices that are equipped with a multifunction input on pin 5 (ODS9.../LAK-...).

To teach, a teach signal is applied to the multifunction input (pin 5). The duration of the teach signal (low level on the teach input) determines the teach-in function.

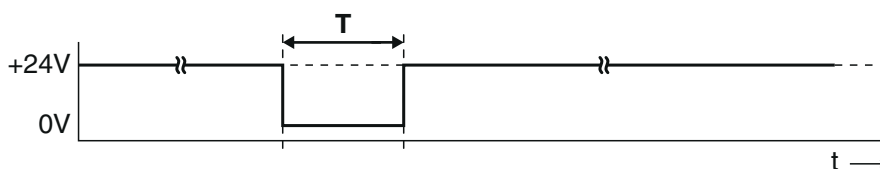

T Duration of the teach signal

Fig. 7.7: Plot of the teach signal

To teach, proceed as follows:

- ↳ In the Configuration menu, activate the input function *Teach* (Default)
Input > Input mode > Teach

☞ Position the measurement object at the desired distance.

NOTICE	
	The teachable area must be located within the measurement range of the sensor.

☞ Apply the teach signal to the multifunction input (pin 5).

- The duration T of the low level at the teach input determines the teach-in function.
- The teach functions assigned to the time frames are preset and can be queried via IO-Link.

Tab. 7.1: Default assignment of the teach functions

Duration T [ms]	Teach function	Function no.
20 ... 80	Object teach of switching output SSC1	14
120 ... 180	Window teach (Window) of switching output SSC1	15
220 ... 280	Analog teach of the distance value for the smallest analog value (4 mA, 1 V, 0 V) on pin 2	6
320 ... 380	Analog teach of the distance value for the largest analog value (20 mA, 10 V) on pin 2	7
420 ... 480	Preset-Offset calculation: determination of an offset value so that the preset Preset value is output as measurement value.	8
520 ... 580	Background-Teach_SSC1	16
620 ... 680	Setpoint 1-Teach SP1_SSC1	12
720 ... 780	Setpoint 2-Teach SP2_SSC1	13
820 ... 880	Alternative setpoint 1-Teach SP1a_SSC1	17
920 ... 980	Logic of SSC1 to 0 "light switching" Light_SSC1	19
1020 ... 1080	Logic of SSC1 to 1 "dark switching" Dark_SSC1	20
1120 ... 1180	Toggle logic of SSC1 "light/dark switching"	18
Corresponding IO-Link object:		
Index 140, teach level assignment (Wire Function Array)		

☞ Detection and averaging of measurement values for forming the teach point TP begins with the rising edge of the input signal.
The parameter or parameters assigned to the time frame for the teach signal is/are updated based on the teach point.

NOTICE	
	<p>☞ With the preset assignment of the teach functions, teaching can only be performed via the multifunction input in <i>SinglePoint Object</i> mode (see chapter 7.1.2 "Setting the switching outputs"). Only the upper setpoint SP1 is then shifted, so that the targeted object is just detected (switching output triggered). More distant objects are no longer detected.</p> <p>☞ Other teach modes are possible via IO-Link system commands (see chapter 7.1.5 "Teaching the output functions via the IO-Link system commands").</p> <p>☞ Alternatively, the assignment table assignments can also be changed or expanded for applicative optimization.</p>

NOTICE	
	A complete process data map of all function indices can be generated via the IODD file. You can find the IODD file on the Internet at www.leuze.com .

- ↪ In the following cases, perform two successive teach actions:
 - Analog output: teach the two positions for start and end of the analog value range
 - Switching output: individually teach setpoints SP1 and SP2 in Window or Two-Point mode
- ↪ Ensure that the taught values are taken over correctly, for example by checking the corresponding entries in the configuration menu.

7.1.5 Teaching the output functions via the IO-Link system commands

A number of output functions can be taught via the IO-Link interface using system commands (see chapter 7.4 "IO-Link interface"). This chapter describes how to teach the analog output and the switching output functions.

Teaching the analog output via IO-Link system commands

To configure the analog output, the two distance values *Position Min. Val.* and *Position Max. Val.* are taught at which the respective minimum or maximum analog value is output.

Value hex / dec	Command	Description
0xC3 / 195	Teach Analog Min	System command: AnalogRangeMin=TP Teaches the distance value to which the lower analog limit value (4 mA, 1 V, 0 V) is assigned (<i>Position Min. Val.</i>).
0xC4 / 196	Teach Analog Max	Teaches the distance value to which the upper analog limit value (20 mA, 10 V) is assigned (<i>Position Max. Val.</i>).

Teaching-in the switching outputs via IO-Link system commands

The teach-in functions are compliant with the *Smart Sensor Profile* specification. Manufacturer-specific extensions are included with two of the three teach-in functions.

NOTICE	
	<p>Detailed descriptions of the teach-in processes can be found in the <i>Smart Sensor Profile</i> specification:</p> <p>http://www.io-link.com/share/Downloads/Smart-Sensor-Profile/IOL-Smart-Sensor-Profile-2ndEd_V10_Mar2017.pdf</p>

Procedure:

- ↪ The so-called "setpoint" (1 and/or 2) is taught.
- ↪ In the second step, the corresponding switching function is defined.

This means that setpoint "SP" is not yet the same as switching point "SSC". Via the switching function / switching mode defined in the second step, the setpoints with the corresponding hystereses become switching points.

If, for example, teaching is performed in Window mode, both setpoints (SP1 and SP2) are taught while retaining the distance to one another.

Tab. 7.2: IO-Link system commands for teaching the switching point modes

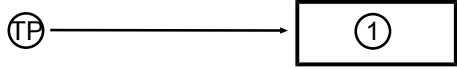
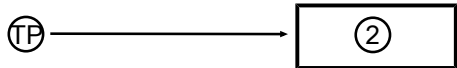
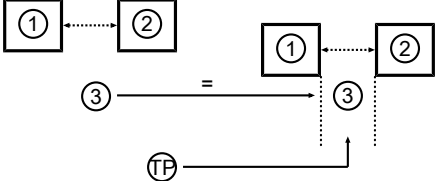
Value hex / dec	Command	Description
0x41 / 65	Teach SP1 IOL_USERCMD_SSP_TEACH_SP1  1: Setpoint SP1 TP: Teachpoint 1	Teaching the far or upper setpoint (SP1): Determine teachpoint 1 for setpoint 1 First select the target (switching point) via command TI select (Index 0x3A = 58): <ul style="list-style-type: none"> • 0 = SSC1 (default) • 1 = SSC1 • 2 = SSC2 • 255 = all together
0x42 / 66	Teach SP2 IOL_USERCMD_SSP_TEACH_SP2  2: Setpoint SP2 TP: Teachpoint 2	Teaching the nearby or lower setpoint (SP2): Determine teachpoint 2 for setpoint 2 First select the target (switching point) via command TI select (Index 0x3A = 58): <ul style="list-style-type: none"> • 0 = SSC1 (default) • 1 = SSC1 • 2 = SSC2 • 255 = all together
0x4B / 75	Custom Teach: window IOL_USERCMD_SSP_CUSTOMTEACH_WINDOW  1: Setpoint SP1 2: Setpoint SP2 3: WindowWidth TP: Teachpoint	Manufacturer-specific teaching of both setpoints SP1 and SP2 together: <ul style="list-style-type: none"> • Retaining the distance between one another • Centered around the teach point (TP) newly determined during the teach event First select the target (switching point) via command TI select (Index 0x3A = 58): <ul style="list-style-type: none"> • 0 = SSC1 (default) • 1 = SSC1 • 2 = SSC2 • 255 = all together Exception: If <i>WindowWidth</i> is not equal to 0, its contents are used instead of the previous distance between the setpoints (SP2-SP1). <i>WindowWidth</i> is a manufacturer-specific extension that is defined additionally for each SSC (Switching Signal Channel or switching output).
0x4C / 76	Custom Teach: SP1a IOL_USERCMD_SSP_CUSTOMTEACH_SP1a	Manufacturer-specific teaching of manufacturer-specific setpoint SP1a. Setpoint SP1a is used instead of SP1 when resetting from <i>Window</i> teach mode to the two <i>SinglePoint</i> teach modes provided its content is not equal to 0.

Teaching the offset value via IO-Link system commands

Value hex / dec	Command	Description
0xD4 / 212	Teach Preset to Offset	At the time the calculation is performed, the offset is corrected so that the nominal value stored under Preset is output.

7.2 Setting measurement value processing and filtering

- ↵ Set the measure mode using the display and the control buttons (Application menu item; see chapter 3.4.6 "Application menu") or using the *Sensor Studio* configuration software (see chapter 8 "Connecting to a PC – Sensor Studio").
 - Standard
Multi-purpose mode (factory setting)
 - Precision
Higher accuracy for measurement tasks with lower dynamics requirements
 - Ambient light
For measurements in which increased ambient light occurs.
 - Less dynamic
 - Increased response times

7.3 Reset to factory settings

Configuration is performed using the OLED display and the keyboard (see chapter 3.4 "Configuration / menu structure") or using the *Sensor Studio* configuration software (see chapter 8 "Connecting to a PC – Sensor Studio").

To reset the sensor via the OLED display and keyboard, proceed as follows:

- ↵ Switch off the voltage supply or disconnect the sensor from the voltage supply.
- ↵ Press the enter button ↵ and hold down the button.
- ↵ Switch on the voltage supply or connect the sensor to the voltage supply.
 - The LEDs for PWR and switching output flash.
- ↵ Press the enter button ↵ again.
- ⇒ The sensor restarts, reset to the factory settings.

7.4 IO-Link interface

7.4.1 Overview

The sensors are equipped with an IO-Link 1.1 interface for configuration and measurement data output.

- The sensor transfers data packets in the TYPE_2_V process data format.
- The process data length is 32 bits. Eight status bits, eight scale bits and 16 measurement value bits are transferred. On the control-side, you can only use the measurement value bits.
- Of the eight possible control input bits, bit 0 is available for deactivation (control signal *Transducer Disable*).
- The sensor cyclically transfers (minCycleTime = 0.5 ms) data packets at a baud rate of 230.4 kBaud (COM3).
- The process data and parameters along with the corresponding system commands are described in the IO Device Description (IODD file).
- ↵ Download the IODD file from the Internet (www.leuze.com).
- ↵ Unpack the ZIP archive to a separate directory. The supplementary HTML files contain a description in tabular form in German and English.
- You can configure the sensor using the *Sensor Studio* configuration software (see chapter 8 "Connecting to a PC – Sensor Studio").

IO-Link system commands

Value hex / dec	Command	Description
0x41 / 65	Teach SP1	Teach the far setpoint.
0x42 / 66	Teach SP2	Teach the near setpoint.
0x4B / 75	Custom Teach: window	Teach both setpoints.
0x4C / 76	Custom Teach: SP1a	Teach the alternative far setpoint.
0x80 / 128	Device Reset	Restart operating software.
0x82 / 130	Restore Factory Settings (Factory Reset)	Reset non-volatile user settings to factory settings.
0xA0 / 160	ClearDsUploadFlag	Delete the <i>DsUpload</i> flag. Delete identifier "Accept sensor configuration in master" again. Counterpart to command 0xA1 ParamDownloadStore. After reconnecting, the sensor configuration is again overwritten by the configuration in the data storage of the master.
0xA1 / 161	ParamDownloadStore	Set the <i>DsUpload</i> flag. End sensor configuration to indicate acceptance in data storage (set <i>DsUpload</i> flag) and, if applicable, trigger data storage via event.
0xB0 / 176	Activation HighPrio	Activation of the sensor (laser or measurement on) with higher priority than the <i>Transducer Disable</i> bit in PDout. If <i>activate</i> or <i>deactivate</i> was selected as the input function, the input has priority over all other requirements.
0xB1 / 177	Deactivation HighPrio	Deactivation of the sensor (laser or measurement on) with higher priority than the <i>Transducer Disable</i> bit in PDout. If <i>activate</i> or <i>deactivate</i> was selected as the input function, the input has priority over all other requirements.
0xB2 / 178	ActivationDeactivation Std-Prio	Resetting of priority to 176 or 177. <i>Transducer Disable</i> in PDout is effective again. Only input functionalities have a higher priority.
0xC3 / 195	Teach Analog Min	Teaching of distance of minimum analog output value (AnalogRangeMin).
0xC4 / 196	Teach Analog Max	Teaching of distance of maximum analog output value (AnalogRangeMax).
0xD4 / 212	Teach Preset to Offset	Teaching of offset to achieve predefined preset value (Offset=Preset TP).

7.4.2 IO-Link process data

Process data format

- Profile: SSP4 (Mixed Measuring Sensor, Switching Measuring Sensor, Disable function)
- M-sequence TYPE_2_V
- PDIn (Sensor -> Master): 32 bits (PDI32.INT16_INT8, 8 status bits, 8 scale bits, 16 measurement value bits)
- PDOOut (Master -> Sensor): 8 control input bits (PDO8.BOOL1)

Status bits

Tab. 7.3: Status bits

Bit	7	6	5	4	3	2	1	0
Value	T	0	W	S	M	0	SSC2	SSC1
0	Reserved, unassigned bits (bit 2 and bit 6) are 0; initialization state is also 0							
M	1: measurement operation 0: during start-up, teaching, deactivation							
S	1: signal OK, reception signal is sufficient for measurement value output							
SSC1	Internally calculated switching states							
SSC2	1: Active							
T	Toggle bit; toggles after a measurement value change due to a trigger edge							
W	1: warning; e.g., weak reception signal During measurement operation, the measurement value is susceptible to interference. The cause for the warning can be read out in ExtStatus Bit2:4.							

Scale bits

Resolution and scaling:

- Measurement value * 10^{Scale} [m]
- Standard resolution (Std): 0xFC = -4 (1/10 mm)
- High resolution (HR): 0xFB = -5 (1/100 mm)

Tab. 7.4: Scale bits

15	14	13	12	11	10	9	8
----	----	----	----	----	----	---	---

Measurement values

16-bit measurement value: distance to the object – between lower and upper limit of the measurement range – in mm. Maximum -32000 ... +32000.

31	30	29	28	27	26	25	24	23	22	21	20	19	18	17	16
----	----	----	----	----	----	----	----	----	----	----	----	----	----	----	----

Special values:

- No measurement values (No Measurement Data): 32764
- Upper limit of the measurement range exceeded (Out of Range (+)): 32760
- Lower limit of the measurement range exceeded (Out of Range (-)): -32760

Control inputs

Tab. 7.5: Control input bits

Bit	7	6	5	4	3	2	1	0
Value	R	R	R	R	R	R	R	Di
Di	Control signal <i>Transducer Disable</i> . 1: Deactivation of the laser							
R	Reserved							

7.5 Serial interface

The ODS9L...8/LFH and ODS9L...8/LQZ sensors are equipped with one switching output and one serial interface, which is implemented either as an RS 232 interface (ODS9L...8/LFH) or as an RS 485 (ODS9L...8/LQZ) interface. The transmission rate can be set to between 2400 baud and 230 kbaud. For configuration and service purposes, the devices with a serial interface have an IO-Link interface on pin 4 (see chapter 7.4 "IO-Link interface").

Serial transmission is performed initially with 1 start bit, 8 data bits and 1 stop bit without parity. The port parameters can be adjusted via the menu or via IO-Link.

For the transmission of the measurement values, 4 different transmission modes may be configured (see chapter 7.5.1 "Measurement value output for various transmission types"):

- ASCII measurement value (6 bytes)
- 14-bit measurement value (2 bytes, ODS 96 compatible)
- 16-bit measurement value (3 bytes, ODSL 30 compatible)
- 24 bit measurement value (4 bytes, measurement value + status byte)
- Decimal measurement value
- Remote control operation

7.5.1 Measurement value output for various transmission types

Object distance	Measurement value output
No evaluable reception signal	65535 (signal too weak)
Below measurement range	Distance value (linearity undefined)
Within measurement range	Linear distance value
Above measurement range	Distance value (linearity undefined)
Device error	65334 (signal error) 65333 (laser error)

Messwert ASCII Übertragung

Übertragungsformat: MMMMM<CR>

MMMMM = Messwert 5-stellig in 0,1 mm (bei 0,1 mm Ausgabeauflösung)

oder = Messwert 5-stellig in 0,01 mm (bei 0,01 mm Ausgabeauflösung)

<CR> = ASCII-Zeichen "Carriage Return" (x0D)

Messwert = 14 Bit

Ausgabeauflösung 0,01 mm / 0,1 mm (typabhängig)

A: Low-Byte (Bit 0=0) B: High-Byte (Bit 0=1)

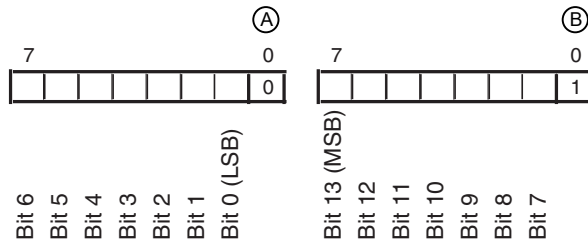

Messwert = 16 Bit

Ausgabeauflösung 0,01 mm / 0,1 mm (typabhängig)

A: Low-Byte (Bit 0=0, Bit 1=0) B: Middle-Byte (Bit 0=1, Bit 1=0) C: High-Byte (Bit 0=0, Bit 1=1)

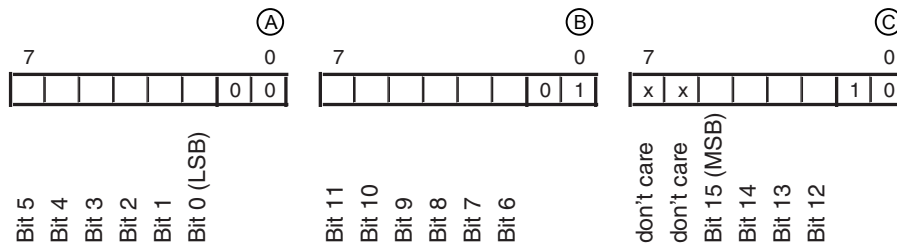

Messwert = 24 Bit

Ausgabeauflösung 0,01 mm / 0,1 mm (typabhängig)

A: Low-Byte (Bit 0=0, Bit 1=0) B: Middle-Byte-1 (Bit 0=1, Bit 1=0) C: Middle-Byte-2 (Bit 0=0, Bit 1=1)

D: High-Byte (Bit 0=1, Bit 1=1) M-Bit: Messwert-Bit S-Bit: Status-Bit

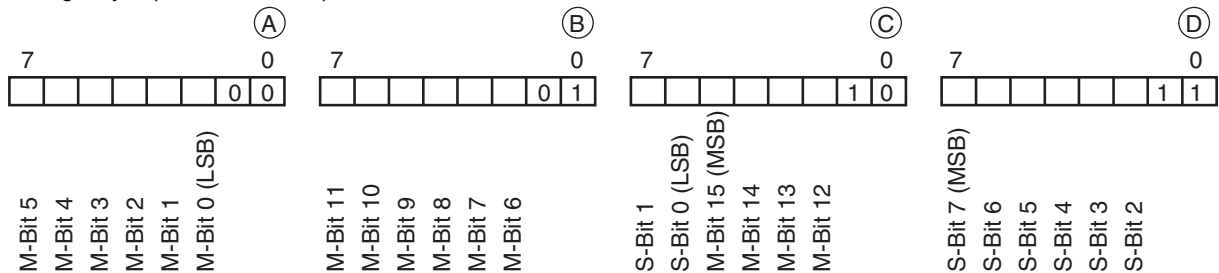

Dezimal-Messwert

Übertragungsformat: (-)MMMMM<CR>

(-) = Minuszeichen bei negativem Wert

MMMMM = Messwert (Länge abhängig von Ausgabeauflösung und Wert)

<CR> = "Carriage Return"

Fernsteuer-Betrieb (Remote Control)

ASCII Übertragung des Messwertes auf Anforderung und Steuerung des ODS
4-stellig (4 Bytes) oder 5-stellig (5 Bytes).

Fig. 7.8: Serial transmission formats ODS 9

7.5.2 Commands for remote control operation

For remote-control operation (**Serial > Com Function > Remote control**), a device address can be set between 0 and 14 (**Serial > Node Address**). In this operating mode, the ODS 9 sensor with serial interface only responds to commands from the control. The following control commands are available:

Measurement value query, 4 digits

		Byte no.								
		0	1	2	3	4	5	6	7	8
Com- mand	Sensor address 0x00 to 0x0E	-	-	-	-	-	-	-	-	-
Sensor re- sponse	"*" (0x2A)	ASCII address		ASCII distance measurement value				"#" (0x23)	-	
		tens	ones	1000's	100's	tens	ones			

The response time of the sensor is maximum 15 ms.

Measurement value query, 5 digits

		Byte no.								
		0	1	2	3	4	5	6	7	8
Com- mand	"*" (0x2A)	ASCII address"0 ... 9", "A... D"	"M" (0x4D)	"#" (0x23)	-	-	-	-	-	-
Sensor re- sponse	"*" (0x2A)	ASCII address"0 ... 9", "A... D"	ASCII distance measurement value					Status	"#" (0x23)	
			10000's	1000's	100's	tens	ones			

The response time of the sensor is maximum 15 ms.

Execute preset measurement

		Byte no.								
		0	1	2	3	4	5	6	7	8
Com- mand	"*" (0x2A)	ASCII address"0 ... 9", "A... D"	"P" (0x52)	"#" (0x23)	-	-	-	-	-	-
Sensor re- sponse	"*" (0x2A)	ASCII address"0 ... 9", "A... D"	Status	"#" (0x23)	-	-	-	-	-	-

The response time of the sensor is maximum 2 s.

Detailed information on Preset/Offset: see chapter 3.4.6 "Application menu"

Activate sensor

	Byte no.								
	0	1	2	3	4	5	6	7	8
Com- mand	"*" (0x2A)	ASCII address"0 ... 9", "A... D"	"A" (0x41)	"#" (0x23)	-	-	-	-	-
Sensor re- sponse	"*" (0x2A)	ASCII address"0 ... 9", "A... D"	Status	"#" (0x23)	-	-	-	-	-

The response time of the sensor is maximum 15 ms.

Deactivate sensor

	Byte no.								
	0	1	2	3	4	5	6	7	8
Com- mand	"*" (0x2A)	ASCII address"0 ... 9", "A... D"	"D" (0x44)	"#" (0x23)	-	-	-	-	-
Sensor re- sponse	"*" (0x2A)	ASCII address"0 ... 9", "A... D"	Status	"#" (0x23)	-	-	-	-	-

The response time of the sensor is maximum 15 ms.

Activate/deactivate sensor via the transducer disable bit

	Byte no.								
	0	1	2	3	4	5	6	7	8
Com- mand	"*" (0x2A)	ASCII address"0 ... 9", "A... D"	"I" (0x49)	"#" (0x23)	-	-	-	-	-
Sensor re- sponse	"*" (0x2A)	ASCII address"0 ... 9", "A... D"	Status	"#" (0x23)	-	-	-	-	-

The response time of the sensor is maximum 15 ms.

Status byte (bitwise processing)

Bit no.	Meaning
7 (MSB)	0 (reserved)
6	0: OK 1: other error (e.g. no measurement possible or preset unsuccessful)
5	1
4	0 (reserved)
3	0 (reserved)
2	0: sensor activated 1: sensor deactivated
1	0: signal OK 1: no or too low signal
0 (LSB)	0: laser OK 1: laser interference

7.5.3 Termination of data lines

The ODS9L...8/LQZ sensor features a combined transmitter and receiver component that can transmit serial data according to the RS 485 standard.

This standard defines some basic rules that should be followed in order to achieve the most reliable data transmission:

- The data lines A and B (which correspond to the pins Tx+ and Tx-) are connected to a characteristic impedance of $Z_0 \approx 120 \Omega$ via a 2-wire twisted pair cable.
- The top and end of the data line are terminated with a 120Ω resistor. The ODS9L...8/LQZ sensor does not have an internal bus termination.
- The RS 485 bus participants are wired in a linear bus topology, i.e., the data line is fed from one bus participant to the next. Stub cables are to be avoided or to be kept as short as possible.
- The RS 485 specification assumes an inactive potential difference of $U_{AB} \geq 200 \text{ mV}$ between the data lines. A bus termination in the form of a voltage divider should be implemented in order to maintain this level. Usually, it is connected to the RS 485 coupling module of the control. If the coupling module does not include a bus termination with voltage divider, the following circuit may be used.

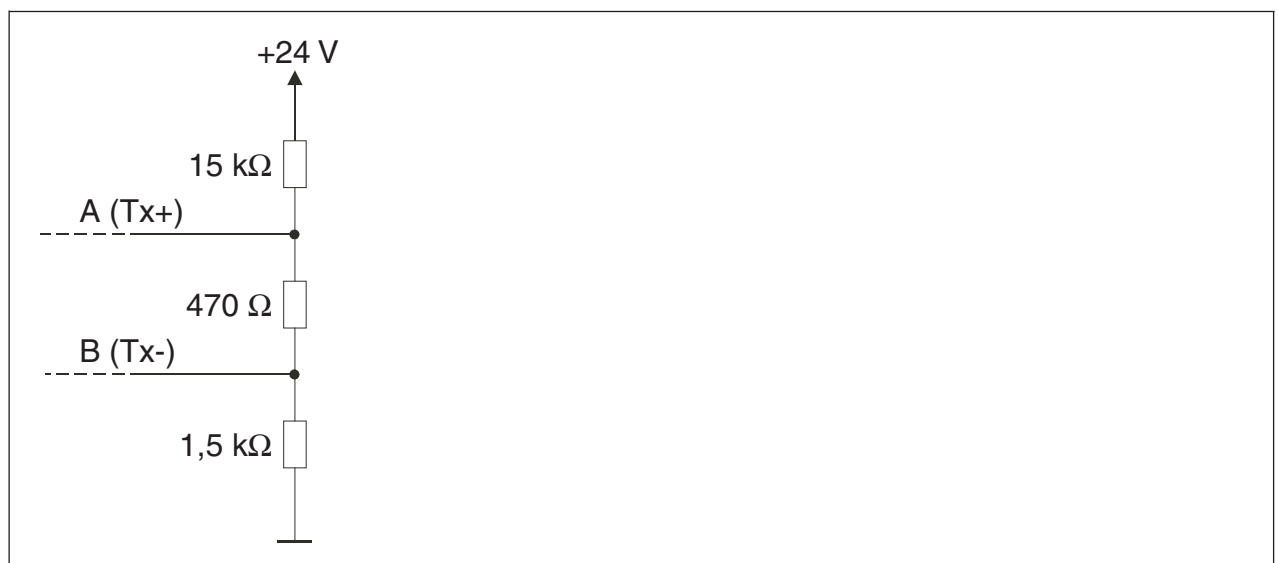

Fig. 7.23: Voltage divider for the RS 485 bus termination

NOTICE

Make sure that the bus bias level ($U_{AB} \geq 200 \text{ mV}$) is observed.

The RS 485 specification permits transmission rates in the megabit range for up to 32 participants. The ODS9L...8/LQZ is designed for a typical data rate of 9,600 baud, 2,400 baud... 230 kBaud can be configured. In practice, this means that the strict requirements regarding the bus termination and the cabling are "softened" for a few bus participants.

7.5.4 Operation on the fieldbus and Ethernet

ODS9L...8/L sensors can be connected to fieldbuses or Ethernet using the IO-Link masters from the Leuze product range (see chapter 13.3.2 "Accessories – IO-Link master").

8 Connecting to a PC – Sensor Studio

The *Sensor Studio* configuration software – in combination with an IO-Link USB master – provides a graphical user interface for the operation, configuration and diagnosis of sensors with IO-Link configuration interface (IO-Link devices), independent of the selected process interface.

Each IO-Link device is described by a corresponding IO Device Description (IODD file). After importing the IODD file into the configuration software, the IO-Link device connected to the IO-Link USB master can be operated, configured and checked – conveniently and in multiple languages. An IO-Link device that is not connected to the PC can be configured offline.

Configurations can be saved and reopened as projects for transferring back to the IO-Link device at a later time.

NOTICE



Only use the *Sensor Studio* configuration software for products manufactured by **Leuze**.

The *Sensor Studio* configuration software is offered in the following languages: German, English, French, Italian and Spanish.

The FDT frame application of the *Sensor Studio* supports all languages; all languages may not be supported in the IO-Link device DTM (Device Type Manager).

The *Sensor Studio* configuration software is designed according to the FDT/DTM concept:

- You make the individual configuration settings for the sensor in the Device Type Manager (DTM).
- The individual DTM configurations of a project can be called up via the frame application of the Field Device Tool (FDT).
- Communication DTM: IO-Link USB master
- Device DTM: I/O-Link Device/IODD for ODS 9

NOTICE



Configuration changes only via the control!

↪ **Always** perform the configuration for process mode via the control and, if applicable, the interface.

In process mode, only the configuration conveyed via the control is active. The configuration changes made via *Sensor Studio* are only active in process mode if they were previously transmitted 1:1 to the control.

Procedure for the installation of the software and hardware:

- ↪ Install the *Sensor Studio* configuration software on the PC.
- ↪ Install the driver for the IO-Link USB master on the PC.
- ↪ Connect the IO-Link USB master to the PC.
- ↪ Connect the OSD 9 (IO-Link device) to the IO-Link USB master.
- ↪ Install IO-Link device DTM with IODD file for ODS 9 in the *Sensor Studio* FDT frame.

8.1 System requirements

To use the *Sensor Studio* configuration software, you need a PC or laptop with the following specifications:

Tab. 8.1: System requirements for Sensor Studio installation

Operating system	Windows 7 or higher
Computer	<ul style="list-style-type: none"> • Processor type: 1 GHz or higher • USB interface • CD-ROM drive • Main memory <ul style="list-style-type: none"> • 1 GB RAM (32-bit operating system) • 2 GB RAM (64-bit operating system) • Keyboard and mouse or touchpad
Graphics card	DirectX 9 graphic device with WDDM 1.0 or higher driver
Additionally required capacity for <i>Sensor Studio</i> and IO-Link device DTM	350 MB hard drive memory 64 MB main memory

NOTICE	
	Administrator privileges on the PC are necessary for installing <i>Sensor Studio</i> .

8.2 Installing Sensor Studio configuration software and IO-Link USB master

NOTICE	
	<p>The installation files of the <i>Sensor Studio</i> configuration software must be downloaded from the Internet at www.leuze.com.</p> <p>For subsequent updates, you can find the most recent version of the installation software on the Internet at www.leuze.com.</p>

8.2.1 Downloading configuration software

- ↗ Call up the Leuze home page: **www.leuze.com**
- ↗ Enter the type designation or part number of the device as the search term.
- ↗ The configuration software can be found on the product page for the device under the *Downloads* tab.

NOTICE	
	On delivery, the device is configured for HID operation (Human Interface Device). The device can thereby be operated directly via the Windows application.

8.2.2 Installing the Sensor Studio FDT frame

NOTICE



First install the software!

- ⤵ Do not yet connect the IO-Link USB master to the PC.
First install the software.

NOTICE



If FDT frame software is already installed on your PC, you do not need the *Sensor Studio* installation.

You can install the communication DTM (IO-Link USB master) and the device DTM (IO-Link device ODS 9) in the existing FDT frame.

- ⤵ Start your PC with administrator privileges and log on.
- ⤵ Download the *Sensor Studio* configuration software from the Internet: www.leuze.com > **Products** > **Measuring sensors** > **Optical distance sensors** > **ODS 9** > **(Device model)** > **Downloads** > **Software/driver**
- ⤵ Copy the file into a suitable folder on your hard drive and unpack the zip file.
- ⤵ Start the *SensorStudioSetup.exe* file and follow the instructions on the screen.
- ⇒ The installation wizard installs the software and places a shortcut on the desktop ().

8.2.3 Installing drivers for IO-Link USB master

- ⤵ Select the **IO-Link USB Master** installation option and follow the instruction on the screen.
- ⇒ The installation wizard installs the software and places a shortcut on the desktop ().

8.2.4 Connecting IO-Link USB master to the PC

The sensor is connected to the PC via the IO-Link USB master (see chapter 13.3.1 "Accessories – PC connection").

☞ Connect the IO-Link USB master to the plug-in power supply unit or the mains supply.

NOTICE	
	<p>Included in the delivery contents of the IO-Link USB master is a USB interconnection cable for connecting the PC to the IO-Link USB master as well as a plug-in power supply unit and a short description.</p> <p>The mains supply of the IO-Link USB master via the plug-in power supply unit is only activated if IO-Link USB master and PC are connected via the USB interconnection cable.</p>

☞ Connect the PC to the IO-Link USB master.

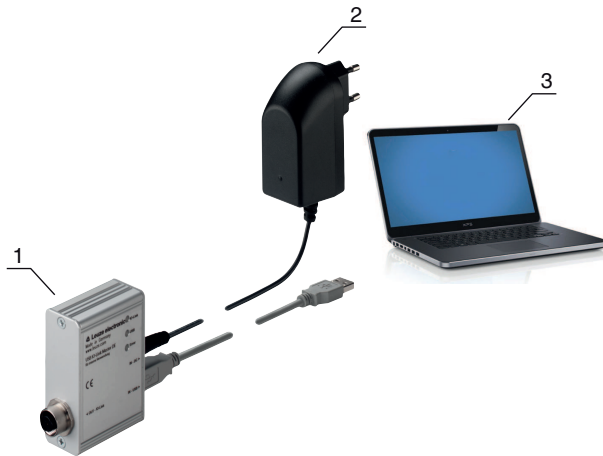

- 1 IO-Link USB master
- 2 Plug-in power supply unit
- 3 PC

Fig. 8.1: PC connection via the IO-Link USB master

⇒ The **wizard for searching for new hardware** starts and installs the driver for the IO-Link USB master on the PC.

8.2.5 Connecting IO-Link USB master to the sensor

Prerequisites:

- IO-Link USB master and PC are connected via the USB interconnection cable.
- IO-Link USB master is connected to the mains supply with the plug-in power supply unit.

NOTICE	
	<p>Connect the plug-in power supply unit for IO-Link USB master!</p> <p>☞ To connect the sensor, the plug-in power supply unit must be connected to the IO-Link USB master and the mains supply.</p> <p>The voltage supply via the USB interface of the PC is permissible only for IO-devices with a current consumption of up to 40 mA at 24 V.</p>

NOTICE	
	<p>Included in the delivery contents of the IO-Link USB master is a USB interconnection cable for connecting the PC to the IO-Link USB master as well as a plug-in power supply unit and a short description.</p> <p>The mains supply of the IO-Link USB master via the plug-in power supply unit is only activated if IO-Link USB master and PC are connected via the USB interconnection cable.</p>

☞ Connect the IO-Link USB master to the M12 connection of the sensor via an interconnection cable. The interconnection cable is not included in the delivery contents and must be ordered separately if needed (see chapter 13.3.1 "Accessories – PC connection").

8.2.6 Installing the DTM and IODD

Prerequisites:

- The sensor is connected to the PC via the IO-Link USB master.
 - FDT frame and driver for IO-Link USB master are installed on the PC.
- ↪ Select the **IO-Link device DTM (User Interface)** installation option and follow the instructions on the screen.
- ⇒ The installation wizard installs the DTM and the IO Device Description (IODD) for the sensor.

NOTICE	
	DTM and IODD for all IO-Link devices currently available from Leuze are installed.

8.2.7 Importing device descriptions

Proceed as follows to manually add device descriptions (DTM and IODD):

- ↪ Unpack the downloaded ZIP file (e.g. *Leuze_ODS9-20180209-IODD1.1.zip*) to a suitable directory on your hard drive, e.g. *ODS9-20180209-IODD1.1*.
- ↪ Copy the directory *ODS9-20180209-IODD1.1* to the following directory:
C:\ProgramData\Leuze\IO-Link Device DTM\IO-Link DDs
- ↪ Open the *Sensor Studio* configuration software. If a project is already open, close it using the menu command **File > New**.
- ↪ Update the DTM general catalog: **Tools > DTM catalog management**:
Click the [Find installed DTMs] button.
Mark the required DTMs in the *Known DTMS* list and move them to the *Current DTM catalog* list ([>] button). You need at least the DTM for the used sensor and the communication DTM IO-Link USB Master 2.0.
- ↪ Click [OK] to exit DTM catalog management.

8.3 Starting the Sensor Studio configuration software

Prerequisites:

- The sensor has been mounted (see chapter 5 "Mounting") and connected (see chapter 6 "Electrical connection") correctly.
 - The *Sensor Studio* configuration software is installed on the PC (see chapter 8.2 "Installing Sensor Studio configuration software and IO-Link USB master").
 - The sensor is connected to the PC via the IO-Link USB master (see chapter 8.2 "Installing Sensor Studio configuration software and IO-Link USB master").
- ↪ Start the *Sensor Studio* configuration software by double-clicking the *Sensor Studio* icon (.
- ⇒ The **mode selection** of the **project wizard** is displayed
- ↪ Select the **Device selection without communication connection (offline)** configuration mode and click on [Next].
- ⇒ The **Project Wizard** displays the **device selection** list of the configurable devices.

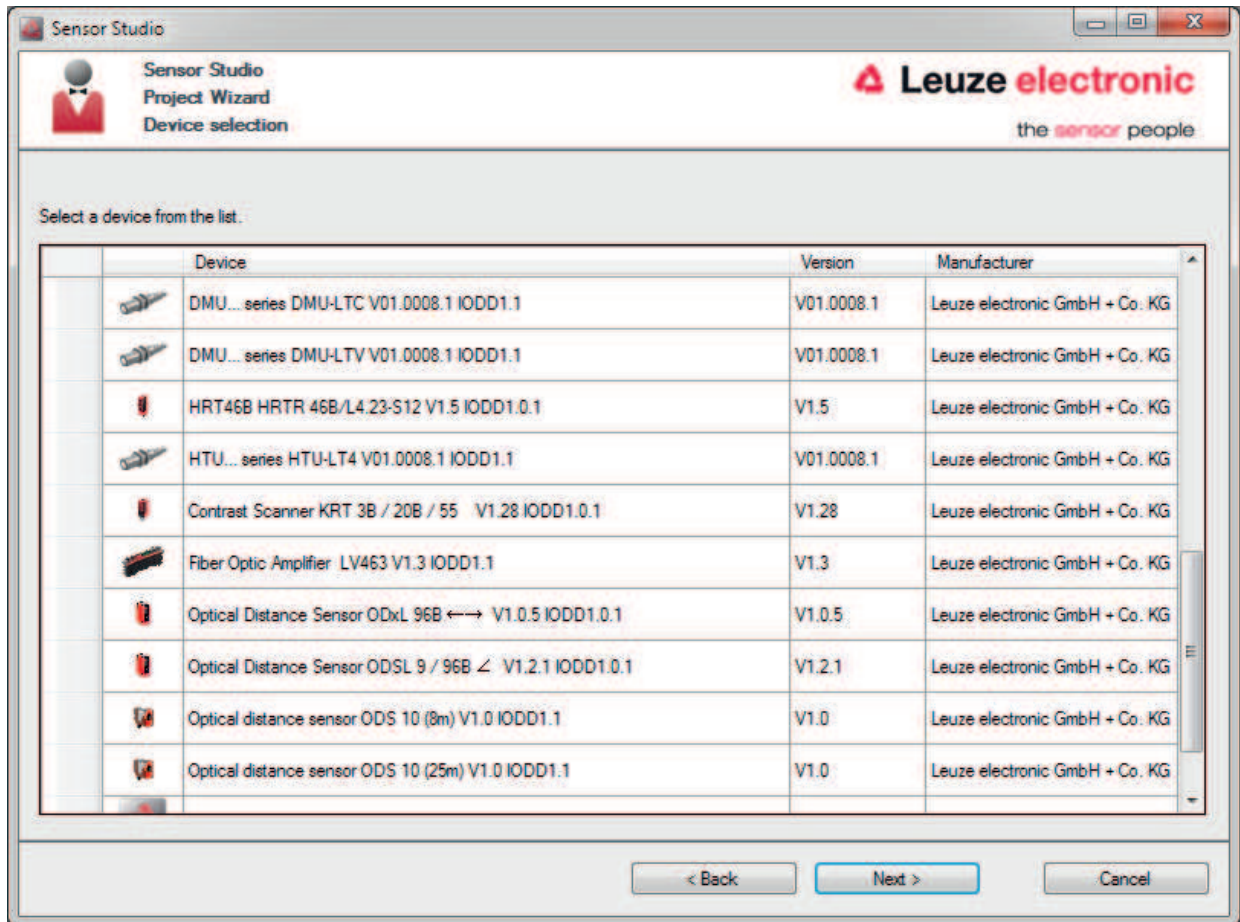

Fig. 8.2: Device selection

NOTICE

The figure shows a similar sensor.

- ↪ Select the connected sensor according to the configuration in the **device selection** and click on [Next].
- ⇒ The device manager (DTM) of the connected sensor starts with the offline view for the *Sensor Studio* configuration project.
- ↪ Establish the online connection to the connected sensor.
In the *Sensor Studio* FDT frame, click on the [Establish connection with device] button (▶).
In the *Sensor Studio* FDT frame, click on the [Online parameters] button (P).
- ⇒ The IO-Link USB master synchronizes with the connected sensor and the current configuration data and measurement data are displayed in the device manager (DTM).

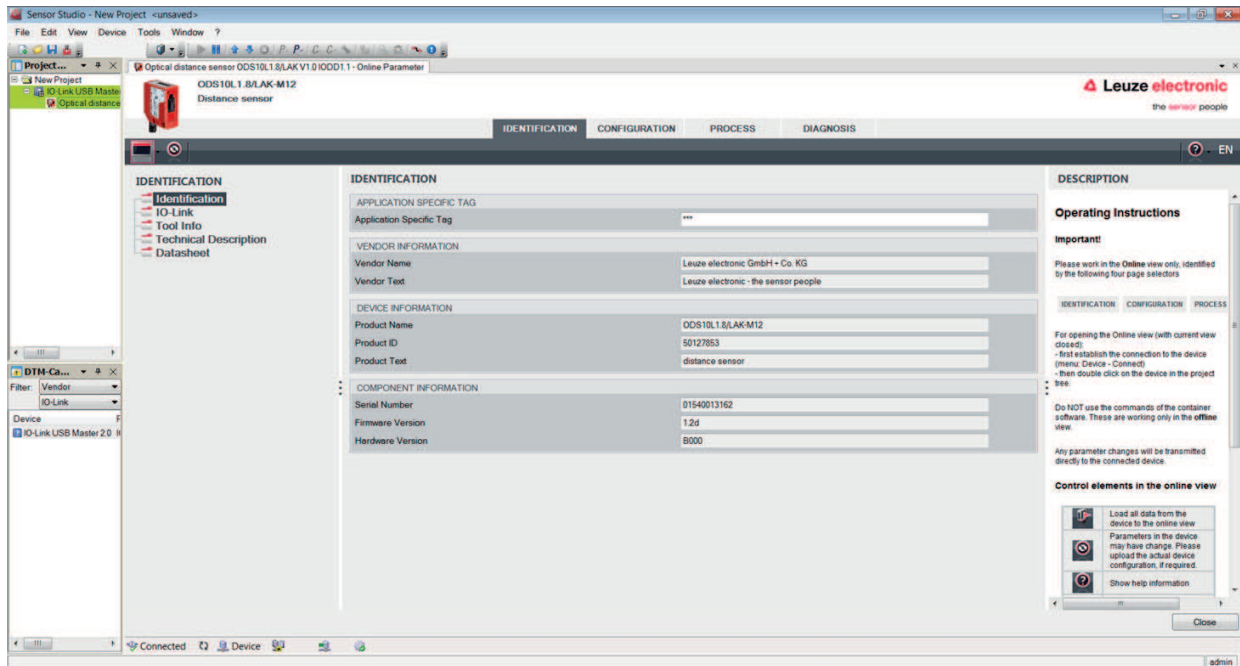

Fig. 8.3: Configuration project: *Sensor Studio* device manager (DTM)

NOTICE

 The figure shows a similar sensor.

The menus of the *Sensor Studio* device manager (DTM) can be used to change or read out the configuration or process data of the connected sensor. The user interface of the *Sensor Studio* device manager (DTM) is largely self-explanatory. The online help system provides information on the menu items and adjustment parameters. Select the **Help** menu item in the menu [?]

8.4 Short description of the *Sensor Studio* configuration software

This chapter contains information and explanations on the individual menu items and adjustment parameters of the *Sensor Studio* configuration software and the device manager (DTM) for the laser distance sensor.

NOTICE

 This chapter does not include a complete description of the *Sensor Studio* configuration software. Complete information on the FDT frame menu and on the functions in the device manager (DTM) can be found in the online help system.

The device manager (DTM) of the *Sensor Studio* configuration software has the following main menus and functions:

- *IDENTIFICATION* (see chapter 8.4.2 "IDENTIFICATION function")
- *CONFIGURATION* (see chapter 8.4.3 "CONFIGURATION function")
- *PROCESS* (see chapter 8.4.4 "PROCESS function")
- *DIAGNOSIS* (see chapter 8.4.5 "DIAGNOSIS function")

NOTICE

 The online help system displays information on the menu items and adjustment parameters for each function. Select the **Help** menu item in the menu [?].

8.4.1 FDT frame menu

NOTICE

 You can find complete information on the FDT frame menu in the online help system. Select the **Help** menu item in the menu [?].

8.4.2 IDENTIFICATION function

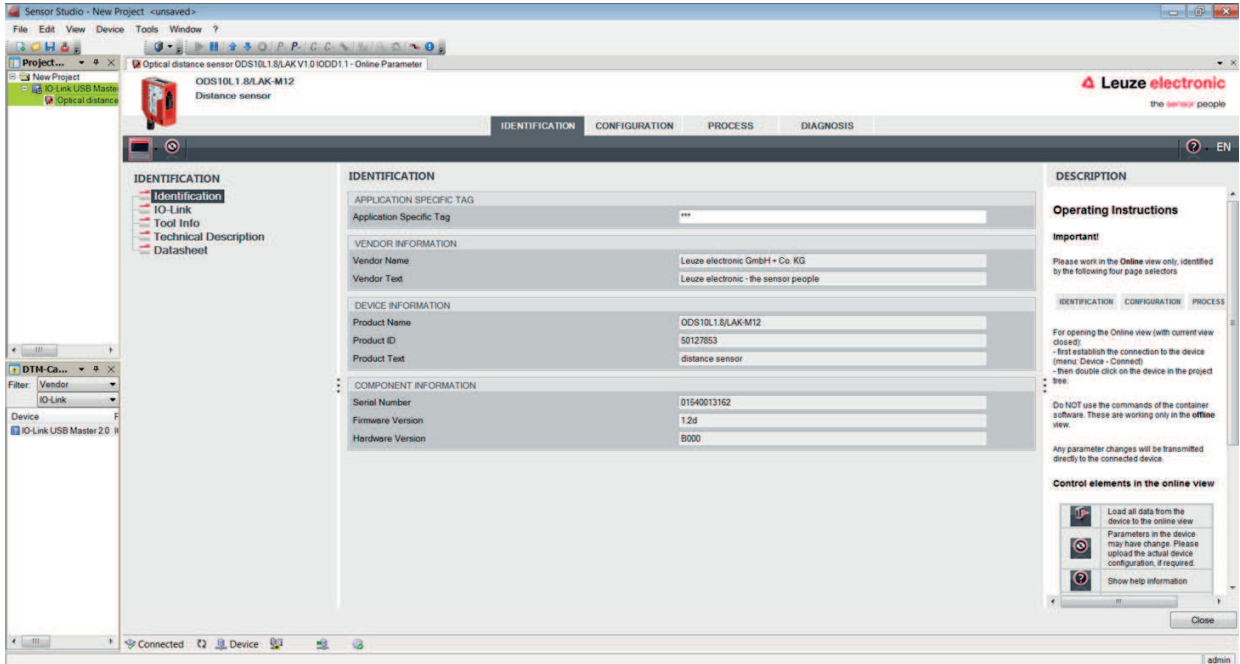

Fig. 8.4: IDENTIFICATION function

NOTICE

 The figure shows a similar sensor.

- Device information, e.g., designation, order no., serial number, etc.
- Information on the IO-Link parameters of the connected sensor, e.g., Device ID, cycle time, etc.
- Assignment of the teach-in functions to the power levels defined by the duration of the teach signal
Optional for devices with input (see chapter 7.1 "Teaching and configuring output functions",)
- Technical description of the connected sensor
- Data sheet of the connected sensor

8.4.3 CONFIGURATION function

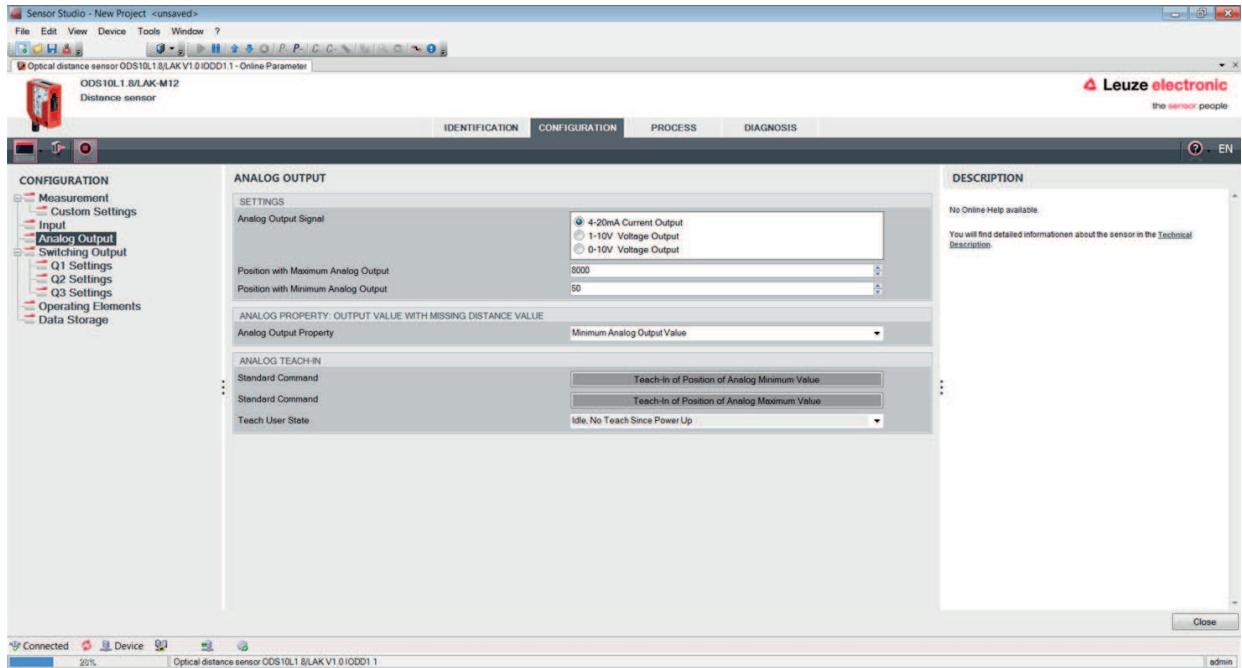

Fig. 8.5: CONFIGURATION function

NOTICE

 The figure shows a similar sensor.

- Configuration of measure mode
- Configuration of analog output functions
- Configuration of digital switching inputs/outputs
- Configuration of local control
- Configuration of data storage
- Configuration of serial interface

Deactivation property

This function is used to determine whether, when the sensor is deactivated, the most recent measurement value to be output is **frozen** or whether the sensor does not output a measurement value at all. The switching outputs which are dependent on the measurement value, and an analog output (if present) behave according to the output measurement value.

- Frozen: The most recent measurement value to be output is **frozen** (default).



Fig. 8.6: Display: Measurement value **frozen** in the case of deactivation

- No Signal: No measurement value is output



Fig. 8.7: Display: No measurement value in the case of deactivation

Input function: Activating/deactivating sensor via switching input

The following options are available:

- Activation: Voltage on the multifunction input activates the sensor
- Deactivation: Voltage on the multifunction input deactivates the sensor
- No function
- Teach
- Trigger rising
- Trigger falling

NOTICE



If you select the *Activation* or *Deactivation* input functions, the functions via IO-Link have no effect (*Transducer Disable* and the associated system commands).

Data storage

The current status of the *DSUpload* (Data Storage Upload) flag stored in the non-volatile memory of the sensor is displayed, provided that cyclical updating is active.

The following functions for changing the *DSUpload* flag are available:

- *Set DSUpload Flag*: Local configuration changes at the sensor remain saved when an IO-Link master is connected, and are transferred to the IO-Link master.
- *Clear DSUpload Flag*: Local configuration changes at the sensor are overwritten when an IO-Link master is connected.

Local configuration lock

This button is used to disable the sensor. Operation via the OLED display and keyboard is only possible after deactivation of the lock via IO-Link or using the configuration software *Sensor Studio*.

8.4.4 PROCESS function

NOTICE

 The figures show a similar sensor.

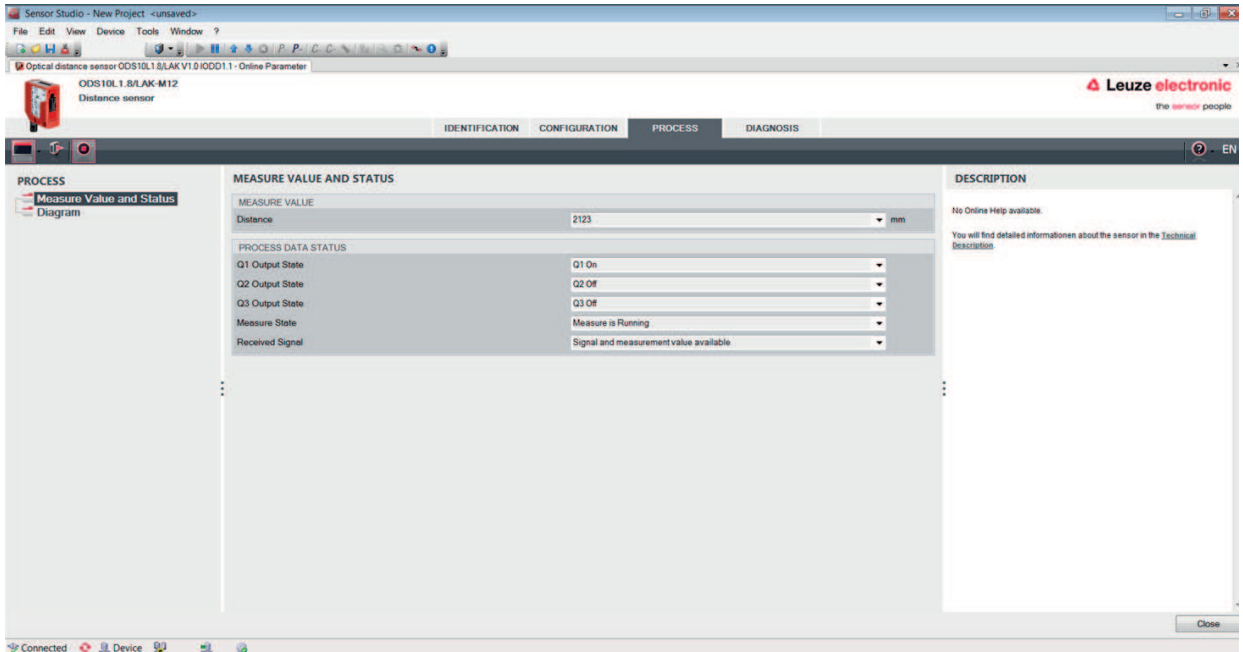

Fig. 8.8: PROCESS function

- Visualization of the distance value and the states of the digital output signals. Text-based display of the current values:

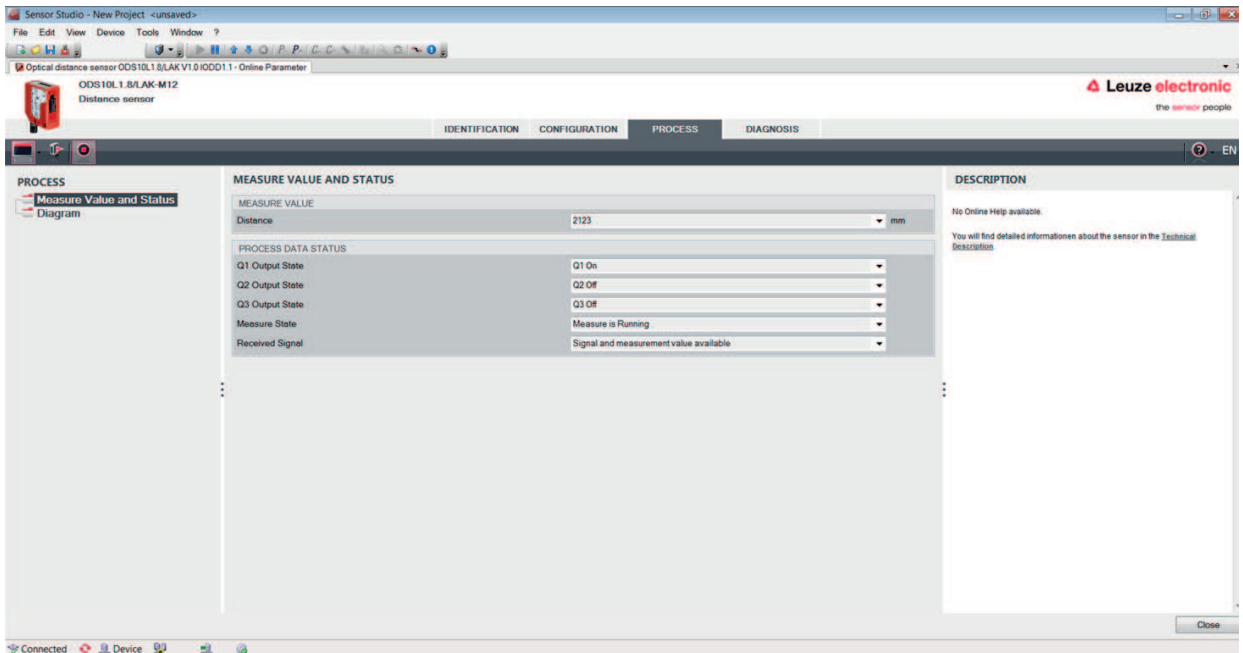

Fig. 8.9: PROCESS function – distance value and status

- Graphical display of the recorded measurement values, including the history:

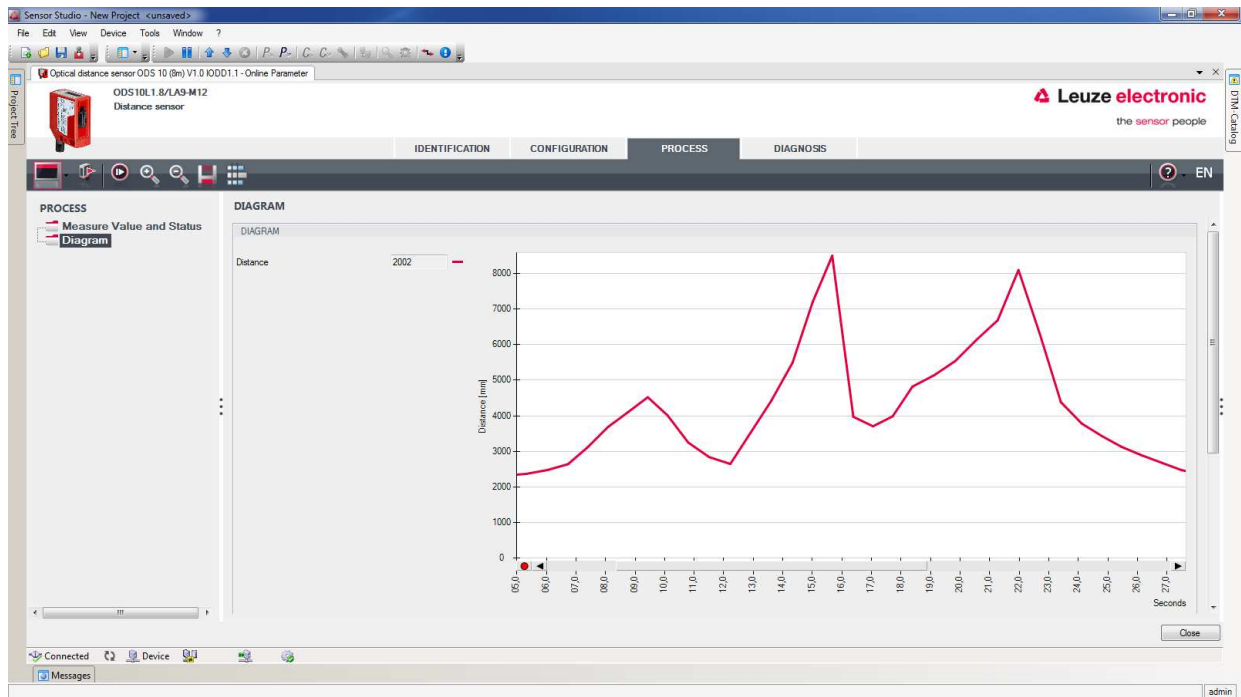

Fig. 8.10: PROCESS function – display of the measurement values

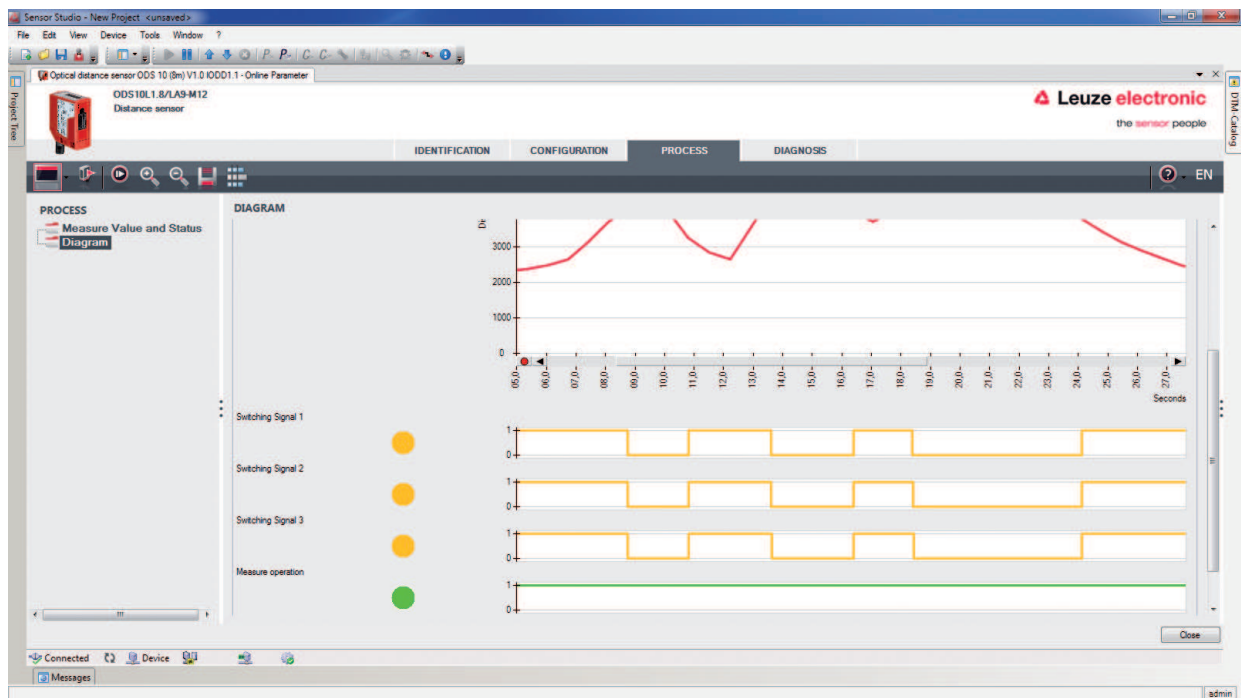

Fig. 8.11: PROCESS function – display of the measurement values

8.4.5 DIAGNOSIS function

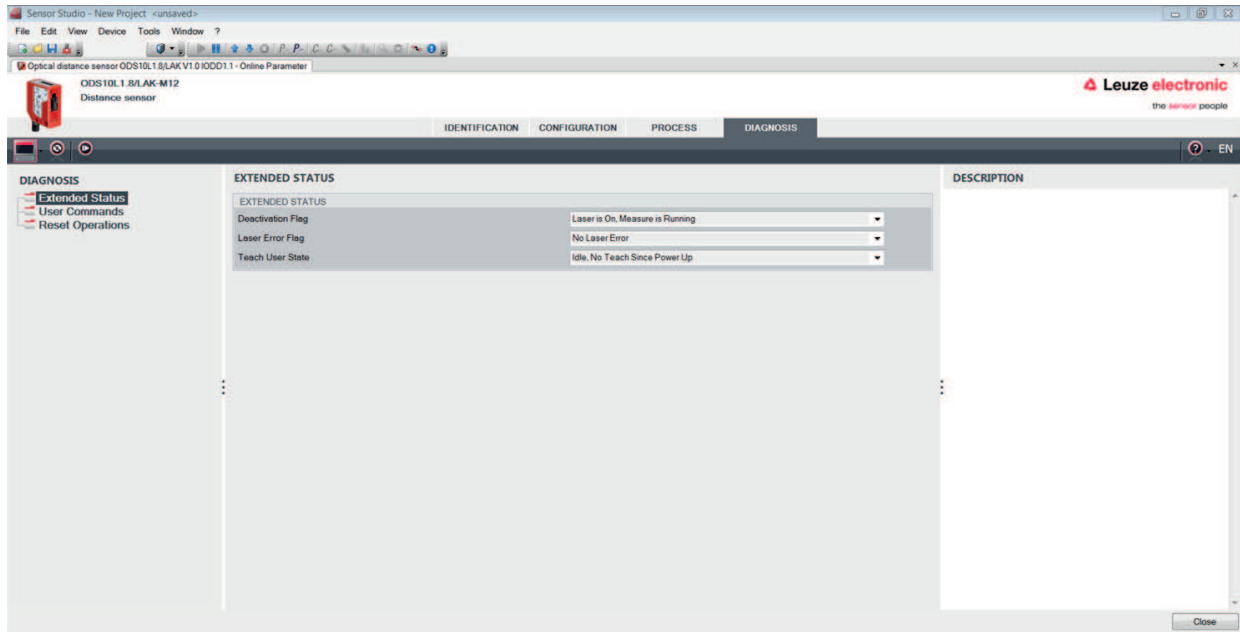

Fig. 8.12: DIAGNOSIS function

NOTICE	
	The figure shows a similar sensor.

- Information on the current device status
- Restart or reset of the device to factory settings
- **User commands**
 - Set or clear the *DSUpload* flag
 - Set DSUpload Flag:* Local configuration changes at the sensor remain saved when an IO-Link master is connected, and are transferred to the IO-Link master.
 - Clear DSUpload Flag:* Local configuration changes at the sensor are overwritten when an IO-Link master is connected.
 - Activate or deactivate the sensor

8.4.6 Exiting Sensor Studio

After completing the configuration settings, close the *Sensor Studio* configuration software.

- ↳ Exit the program via **File > Exit**.
- ↳ Save the configuration settings as a configuration project on the PC.

You can open the configuration project again at later time via **File > Open** or via the *Sensor Studio* project wizard ().

9 Troubleshooting

9.1 What to do in case of failure?

After switching on the sensor, display elements (see chapter 3.3 "Indicators and operational controls") assist in checking the proper function and troubleshooting.

In case of error, you can determine the error from the LEDs and the indicators on the display. With the error message you can determine the cause of the error and initiate measures to rectify it.

↪ Switch off the system and leave it switched off.

↪ Analyze the cause of the error using the operation indicators, the error messages and with the help of the *Sensor Studio* configuration software, **DIAGNOSTICS** menu, and rectify the error.

NOTICE	
	<p>Contact Leuze subsidiary/customer service.</p> <p>↪ If you are unable to rectify a fault, contact the Leuze branch responsible for you or call the Leuze customer service (see chapter 11 "Service and support").</p>

9.2 LED indicators

You can use the LED indicators to ascertain general causes of errors (see chapter 3.3.1 "LED indicators").

Tab. 9.1: Green LED – causes and measures

Error display	Possible cause	Measures
Off	<ul style="list-style-type: none"> No supply voltage connected to the sensor Hardware error 	<ul style="list-style-type: none"> Check supply voltage Contact Leuze customer service (see chapter 11 "Service and support")





Tab. 9.2: Orange LED – causes and measures

Error display	Possible cause	Measures
Off	No object detected in the switching range	Position object in the configured switching range

9.3 Indicators in the display

You can use the status indicators in the display to ascertain general error causes; (see chapter 3.3.3 "Display").

Tab. 9.3: Display indicators – causes and measures

Display	Possible cause	Measures
	Warning message, e.g., weak reception signal	Optimize object alignment
	No object detected or reception signal too weak	Position object in the measurement range
	Signal failure Sensor defective	If the icon is displayed continuously: contact Leuze customer service (see chapter 11 "Service and support")
	The current measurement value is less than the lower limit of the analog output distance	Change the setting for the lower limit of the measurement range (see chapter 3.4.4 "Analog_Output menu")
	The current measurement value is greater than the upper limit of the analog output distance	Change the setting for the upper limit of the measurement range (see chapter 3.4.4 "Analog_Output menu")

10 Care, maintenance and disposal

10.1 Cleaning

If there is dust on the device:

- ↪ Clean the device with a soft cloth; use a cleaning agent (commercially available glass cleaner) if necessary.

NOTICE



Do not use aggressive cleaning agents!

- ↪ Do not use aggressive cleaning agents such as thinner or acetone for cleaning the device. Use of improper cleaning agents can damage the lens cover.

10.2 Servicing

The device does not normally require any maintenance by the operator.

Repairs to the device must only be carried out by the manufacturer.

- ↪ For repairs, contact your responsible Leuze subsidiary or Leuze customer service (see chapter 11 "Service and support").

10.3 Disposing

- ↪ For disposal observe the applicable national regulations regarding electronic components.

11 Service and support

24-hour on-call service at:

+49 7021 573-0

Service hotline:

+49 7021 573-123

Monday to Friday 8.00 a.m. to 5.00 p.m. (UTC+1)

E-mail:

service.identify@leuze.de

Repair service and returns:

Procedure and Internet form can be found at

www.leuze.com/repair

Return address for repairs:

Service center

Leuze electronic GmbH + Co. KG

In der Braike 1

D-73277 Owen / Germany

11.1 What to do should servicing be required?

What to do should servicing be required?

NOTICE	
	<p>Please use this chapter as a master copy should servicing be required!</p> <p>↪ Enter the contact information and fax this form together with your service order to the fax number given below.</p>

Customer data (please complete)

Device type:	
Serial number:	
Firmware:	
Display messages	
Status of LEDs:	
Error description:	
Company:	
Contact person/department:	
Phone (direct dial):	
Fax:	
Street/No:	
ZIP code/City:	
Country:	

Leuze Service fax number:

+49 7021 573-199

12 Technical data

12.1 Measurement data

Tab. 12.1: Measurement ranges

ODS9...-100...	50 mm ... 100 mm	6 % ... 90 % diffuse reflection Measurement against diffusely reflective objects
ODS9...-200...	50 mm ... 200 mm	
ODS9...-450...	50 mm ... 450 mm	
ODS9...-650...	50 mm ... 650 mm	

Tab. 12.2: Accuracy

Resolution	ODS9...-100...	0.01 mm
	ODS9...-200...	0.01 mm of 50 mm ... 100 mm 0.1 mm of 100 mm ... 200 mm
	ODS9...-450...	0.1 mm
	ODS9...-650...	0.1 mm
Temperature deviation (in % of measurement value)		≤ ±0.02 %/K
Accuracy (in % of measurement value)	ODS9...-100...	±0.5 %
	ODS9...-200...	±0.5 % of 50 mm ... 100 mm ±1 % of 100 mm ... 200 mm
	ODS9...-450...	±1 %
	ODS9...-650...	±1 %
<ul style="list-style-type: none"> • Diffuse reflection: 6 % ... 90 % • Measure mode: Standard • At 20 °C after warmup time of 20 minutes 		

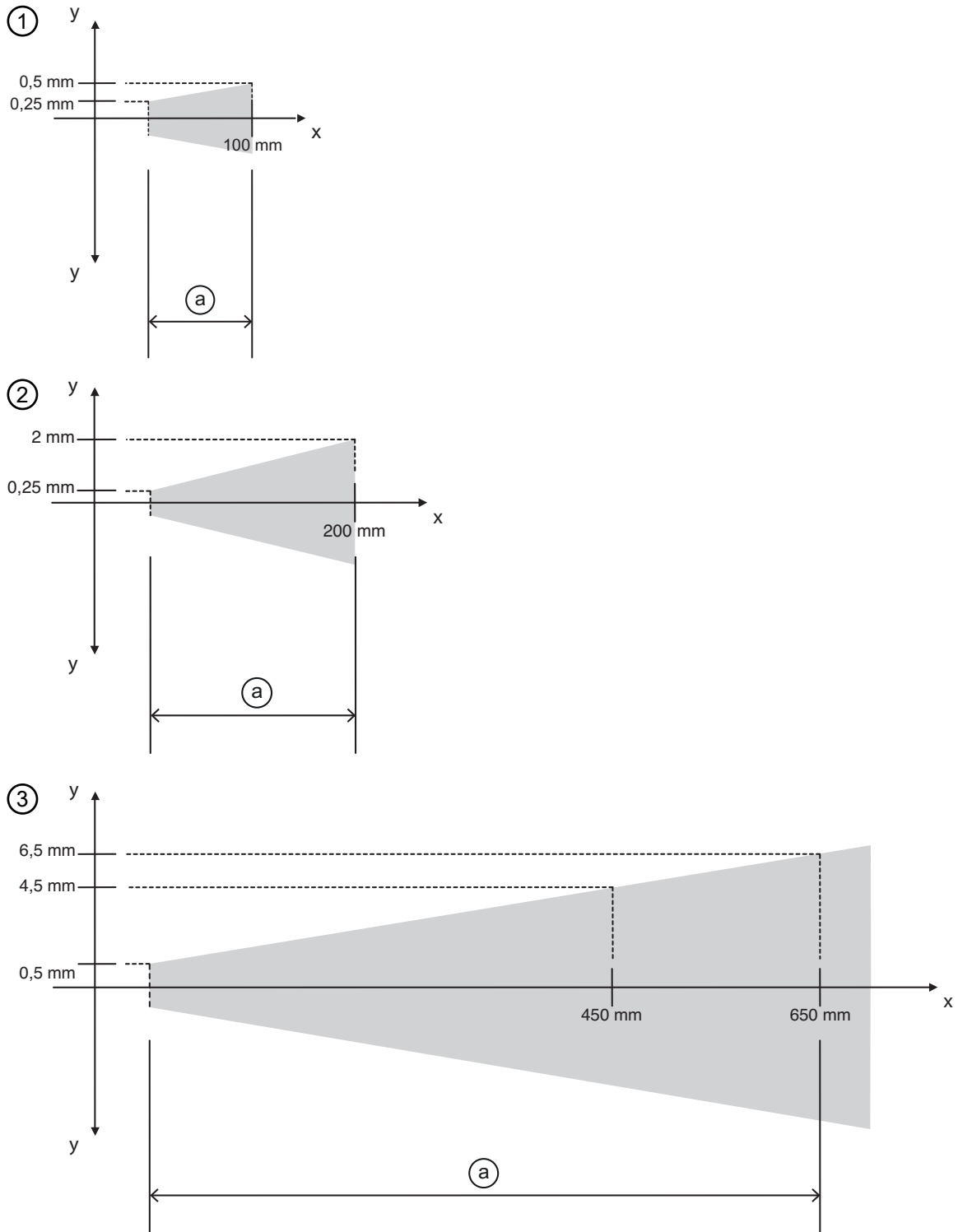

x	Measurement range
y	Maximum measurement error (+/-)
Gray area	Permissible measurement deviation
1	Accuracy up to 100 mm, a = 0.5% of the measurement value
2	Accuracy up to 200 mm, a = 1% of the measurement value
3	Accuracy up to 450 mm and 650 mm, a = 1% of the measurement value

Fig. 12.1: ODS 9 measurement accuracy

Reproducibility

- 3 sigma: 0.2 mm
- Diffuse reflectance: 6 % ... 90 %
- At 20 °C after warmup time of 20 minutes

12.2 Optical data

Tab. 12.3: Optical data

Light source	Laser diode ODS9L1: Laser class 1 acc. to IEC 60825-1:2014 ODS9L2: Laser class 2 acc. to IEC 60825-1:2014
Wavelength	650 nm (red, visible)
Pulse duration	22 ms
Max. output power (peak)	ODS9L1...: 0.78 mW ODS9L2...: 1.8 mW
Light spot	approx. 1 mm x 1 mm

12.3 Indicators and operational controls

Tab. 12.4: Indicators/operational controls

Display	OLED display
Keyboard	Two buttons
LEDs on the control panel	PWR: status LED, green SSC: LED for object detection/switching output, orange

12.4 Electrical data

Tab. 12.5: Electrical equipment

Operating voltage U_B Supply voltage	18 V ... 30 V DC incl. residual ripple
Residual ripple	$\leq 15\%$ of U_B
Open-circuit current	≤ 50 mA
Switching output	Push-pull switching output NOTE! The push-pull switching outputs must not be connected in parallel.
Signal voltage high/low	$\geq (U_B - 2\text{ V}) / \leq 2\text{ V}$
Analog output ODS9L1.8/LA...	<ul style="list-style-type: none"> • Voltage 1 V ... 10 V / 0 V ... 10 V $R_L \geq 2\text{ k}\Omega$ • Current (factory setting) 4 mA ... 20 mA, $R_L \leq 500\ \Omega$
IO-Link	COM3 (230.4 kBaud), Vers. 1.1 min. cycle time: 0.5 ms SIO is supported
Serial interface RS 232 / RS 485	9,600 baud (factory setting, baud rate configurable)

12.5 Mechanical data

Tab. 12.6: Mechanical data

Housing	Plastic
Optics cover	Glass, ODS9Lx.8/xxx.P: plastic
Weight	85 g
Connection type	M12 connector, turnable by 90°

12.6 Environmental data

Tab. 12.7: Environmental data

Ambient temperature (operation)	-20 °C ... +50 °C
Ambient temperature (storage)	-30 °C ... +70 °C
Protective circuit	Transient protection Polarity reversal protection Short circuit protection for all outputs
VDE protection class	III
Degree of protection with correctly screwed-on M12 connector	IP67
Standards applied	IEC 60947-5-2

12.7 Dimensioned drawings

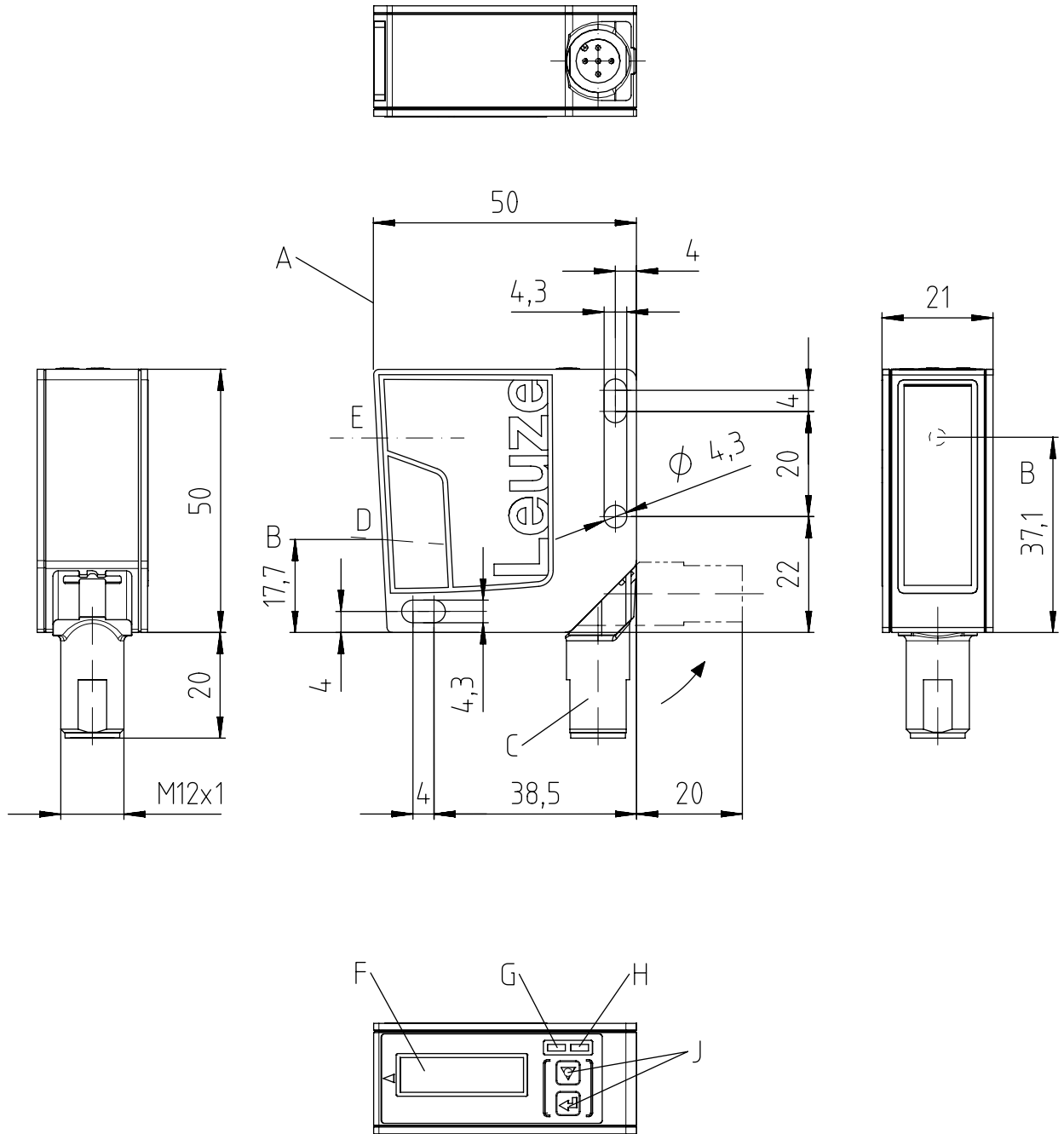

All dimensions in mm

- A Reference edge for the measurement
- B Optical axis
- C M12 connector, turnable by 90°
- D Receiver
- E Transmitter
- F Display
- G Yellow LED – switching output state
- H Green LED – operating state
- J Control buttons

Fig. 12.2: Dimensioned drawing ODS 9 with M12 connector

12.8 Dimensioned drawings: Accessories

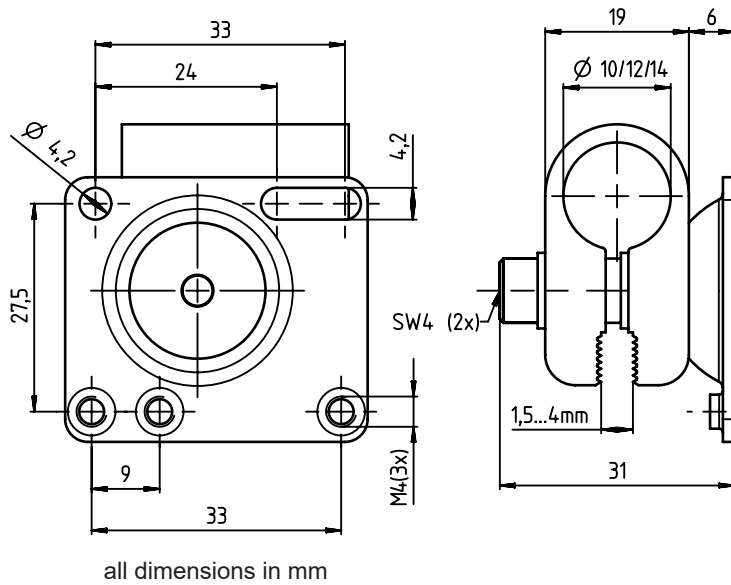

Fig. 12.3: Dimensioned drawing mounting system BTU 300M-D10/D12/D14

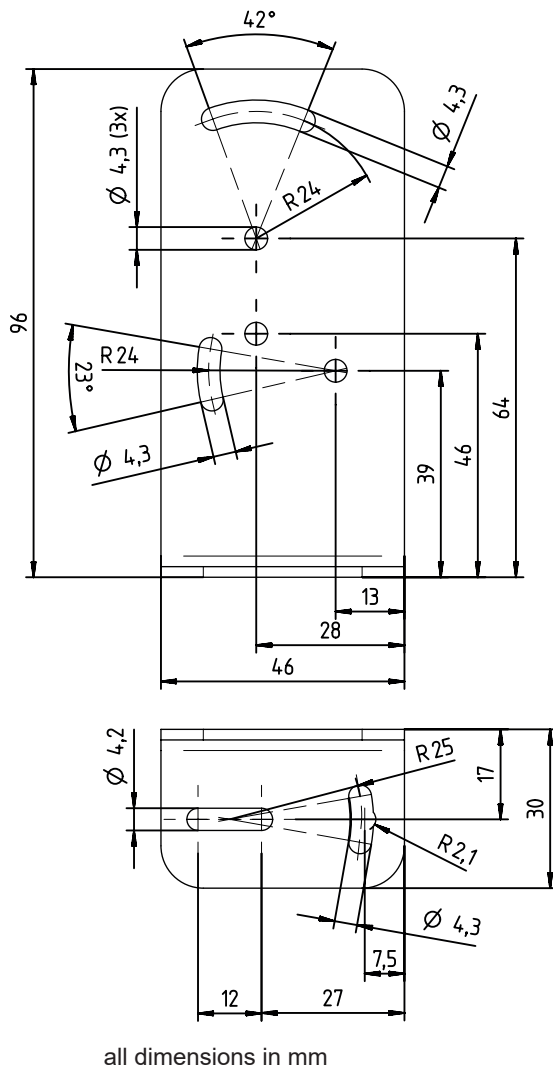

Fig. 12.4: Dimensioned drawing mounting bracket BT 300M.5

13 Order guide and accessories

13.1 Type overview ODS 9

Optical distance sensors, measurement against object

NOTICE



The types given in the overview below can change or be supplemented with further models.

NOTICE



If the IO-Link interface is not used, all device models are equipped with a switching output on pin 4.

Part no.	Part designation	Description
50137820	ODS9L2.8/LAK-100-M12	100 mm max. measurement distance, IO-Link interface, analog output, multifunction input
50137819	ODS9L2.8/LAK-200-M12	200 mm max. measurement distance, IO-Link interface, analog output, multifunction input
50137818	ODS9L2.8/LAK-450-M12	450 mm max. measurement distance, IO-Link interface, analog output, multifunction input
50137817	ODS9L2.8/LAK-650-M12	650 mm max. measurement distance, IO-Link interface, analog output, multifunction input
50137816	ODS9L2.8/LA6-100-M12	100 mm max. measurement distance, IO-Link interface, analog output, second multifunction input
50137815	ODS9L2.8/LA6-200-M12	200 mm max. measurement distance, IO-Link interface, analog output, second multifunction input
50137813	ODS9L2.8/LA6-450-M12	450 mm max. measurement distance, IO-Link interface, analog output, second multifunction input
50136953	ODS9L2.8/LA6-650-M12	650 mm max. measurement distance, IO-Link interface, analog output, second multifunction input
50137824	ODS9L2.8/L6X-100-M12	100 mm max. measurement distance, IO-Link interface, switching output
50137823	ODS9L2.8/L6X-200-M12	200 mm max. measurement distance, IO-Link interface, switching output
50137822	ODS9L2.8/L6X-450-M12	450 mm max. measurement distance, IO-Link interface, switching output
50137821	ODS9L2.8/L6X-650-M12	650 mm max. measurement distance, IO-Link interface, switching output
50138326	ODS9L2.8/LFH-100-M12	100 mm max. measurement distance, IO-Link interface, serial interface RS 232
50138327	ODS9L2.8/LFH-450-M12	450 mm max. measurement distance, IO-Link interface, serial interface RS 232
50138328	ODS9L2.8/LQZ-100-M12	100 mm max. measurement distance, IO-Link interface, serial interface RS 485
50138329	ODS9L2.8/LQZ-450-M12	450 mm max. measurement distance, IO-Link interface, serial interface RS 485
50138330	ODS9L2.8/LQZ-650-M12	650 mm max. measurement distance, IO-Link interface, serial interface RS 485

Part no.	Part designation	Description
50141322	ODS9L1.8/LAK-450-M12	450 mm max. measurement distance, IO-Link interface, switching output

13.2 Accessories – cables and connectors

NOTICE



⚠ To avoid electromagnetic interference, use shielded connection cables when using the analog output.

Tab. 13.1: Cables and connectors

Part no.	Part designation	Description
50020501	KD 095-5A	M12 connector (cable socket), user-configurable, 5-pin, axial
50020502	KD 095-5	M12 connector (cable socket), user-configurable, 5-pin, angled
50132077	KD U-M12-5A-V1-020	Connection cable with M12 connector on one end, 5-pin, M12, axial, length 2 m, PVC sheathing
50133842	KD U-M12-5W-V1-020	Connection cable with M12 connector on one end, 5-pin, M12, angled, length 2 m, PVC sheathing
50133855	KD S-M12-5A-V1-020	Shielded connection cable with M12 connector on one end, 5-pin, M12, axial, length 2 m, PVC sheathing
50132079	KD U-M12-5A-V1-050	Connection cable with M12 connector on one end, 5-pin, M12, axial, length 5 m, PVC sheathing
50133802	KD U-M12-5W-V1-050	Connection cable with M12 connector on one end, 5-pin, M12, angled, length 5 m, PVC sheathing
50133856	KD S-M12-5A-V1-050	Shielded connection cable with M12 connector on one end, 5-pin, M12, axial, length 5 m, PVC sheathing
50132080	KD U-M12-5A-V1-100	Connection cable with M12 connector on one end, 5-pin, M12, axial, length 10 m, PVC sheathing
50133803	KD U-M12-5W-V1-100	Connection cable with M12 connector on one end, 5-pin, M12, angled, length 10 m, PVC sheathing
50133857	KD S-M12-5A-V1-100	Shielded connection cable with M12 connector on one end, 5-pin, M12, axial, length 10 m, PVC sheathing
50130692	KD U-M12-4W-P1-020	PUR connection cable with M12 connector on one end, 4-pin, M12, angled, length 2 m Only for devices ODS9.../L6X...
50130728	KD S-M12-4W-P1-020	Shielded PUR connection cable with M12 connector on one end, 4-pin, M12, angled, length 2 m Only for devices ODS9.../L6X...
50133839	KD U-M12-5A-P1-020	PUR connection cable with M12 connector on one end, 5-pin, M12, axial, length 2 m
50132536	KD U-M12-5W-P1-020	PUR connection cable with M12 connector on one end, 5-pin, M12, angled, length 2 m
50133859	KD S-M12-5A-P1-020	Shielded PUR connection cable with M12 connector on one end, 5-pin, M12, axial, length 2 m

Part no.	Part designation	Description
50133862	KD S-M12-5W-P1-020	Shielded PUR connection cable with M12 connector on one end, 5-pin, M12, angled, length 2 m
50133841	KD U-M12-5A-P1-050	PUR connection cable with M12 connector on one end, 5-pin, M12, axial, length 5 m
50133860	KD S-M12-5W-P1-050	Shielded PUR connection cable with M12 connector on one end, 5-pin, M12, axial, length 5 m
50115049	K-DS M12A-MA-5P-3m-S-PUR	PUR connection cable with RS232 to MA 2xxi modular connection units, M12 connector on one end, 5-pin, A-coded, axial, 2nd connection JST ZHR, 12-pin, length 3 m

13.3 Other accessories

Tab. 13.2: Other accessories

Part no.	Part designation	Description
50117251	BTU 300M-D14	Mounting system for mounting on rods Ø 14 mm
50117252	BTU 300M-D12	Mounting system for mounting on rods Ø 12 mm
50117253	BTU 300M-D10	Mounting system for mounting on rods Ø 10 mm
50118543	BT 300M.5	Mounting bracket

13.3.1 Accessories – PC connection

Tab. 13.3: Accessories - PC connection configuration

Part no.	Part designation	Description
IO-Link USB master V2.0		
50121098	SET MD12-US2-IL1.1 + accessories	IO-Link USB master V2.0 Plug-in power supply unit (24 V/24 W) with international adapters High-speed USB 2.0 connection cable; USB A to Mini-USB Data carrier with software, drivers and documentation
50110126	K-DS M12A-M12A-4P-2m-PVC	Interconnection cable with M12 connector on both ends, 4-pin, M12, axial, length 2 m, PVC sheathing

13.3.2 Accessories – IO-Link master

Tab. 13.4: Accessories – IO-Link master

Part no.	Part designation	Description
50131482	MD748i-11-42/L5-2222	IO-Link master Interfaces: PROFINET
50131483	MD248i-12-8K/L4-2R2K	IO-Link master for top-hat rail mounting in switch cabinet Interfaces: PROFINET
50131484	MD758i-11-42/L5-2222	IO-Link master Interfaces: EtherNet/IP, Modbus TCP
50131485	MD258i-12-8K/L4-2R2K	IO-Link master for top-hat rail mounting in switch cabinet Interfaces: EtherNet/IP, Modbus TCP

14 EC Declaration of Conformity

The optical distance sensor systems of the ODS 9 series were developed and manufactured in accordance with the applicable European standards and directives.

The manufacturer of the product, **Leuze electronic GmbH + Co. KG** in D-73277 Owen, possesses a certified quality assurance system in accordance with ISO 9001.

