



RFN200
Motor protection
relay

Product designation

Product type designation

General characteristics

Number of poles	Nr.	3
Overvoltage category		III
Pollution degree		3
Frontal IP degree		IP20
Type of release		Thermal
Protection fuse		
	gG (IEC)	A 250
	aM (IEC)	A 160
	K5 (UL)	A 500
Phase failure detection		no
Reset mode		Manual or automatic

Power circuit characteristics

Rated insulation voltage U_i IEC/EN	V	1000
Rated impulse withstand voltage U_{imp}	kV	6
Rated operational voltage	V	690
Operational frequency		
	min	Hz 50
	max	Hz 60
Operational current I_e		
	Operational current min	A 90
	Operational current max	A 150
Tripping class		10A
Test Button		yes
Trip indicator		yes

Terminals

type	screw and flat washer
screw	M8
width	mm 20
tool	Bar 13mm

Tightening torque for terminals

min	Nm	18
max	Nm	18
min	lbin	13.3
max	lbin	13.3

Auxiliary circuit characteristics

Auxiliary contacts

NO	Nr.	1
NC	Nr.	1

Auxiliary Rated insulation voltage U_i IEC/EN V 690

Auxiliary Rated impulse withstand voltage Uimp		kV	6
Auxiliary Rated operational voltage		V	690
Operating current AC15	24V	A	3
	120V	A	3
	240V	A	1.5
	380V	A	0.95
	480V	A	0.75
	500V	A	0.72
Operating current DC13	600V	A	0.6
	125V	A	0.11
	600V	A	0.22
IEC Conventional free air thermal current Ith		A	10
Terminals			
	Auxiliary circuit type		screw and washer
	Auxiliary circuit screw		M3,5
	Auxiliary circuit width	mm	8
	Auxiliary circuit tool		Phillips 2
Conductor section			
	Auxiliary circuit Flexible w/o lug max	mm ²	2.5
	Auxiliary circuit Flexible c/w lug max	mm ²	2.5
Tightening torque for terminals			
	Auxiliary circuit min	Nm	0.8
	Auxiliary circuit max	Nm	1
	Auxiliary circuit min	lbin	0.59
	Auxiliary circuit max	lbin	0.74
UL/CSA and IEC/EN 60947-5-1 designation			B600-R300
Ambient conditions			
Operating temperature			
	min	°C	-25
	max	°C	60
Storage temperature			
	min	°C	-50
	max	°C	70
Compensation temperature			
	min	°C	-20
	max	°C	60
Max altitude		m	3000
Mechanical features			
Operating position			
	normal allowable		Vertical plan ±30°
Fixing			Screw
Weight		g	2150
UL technical data			
Full-load current (FLA) for three-phase AC motor			
	at 480V	A	150
	at 600V	A	150
Dimensions			

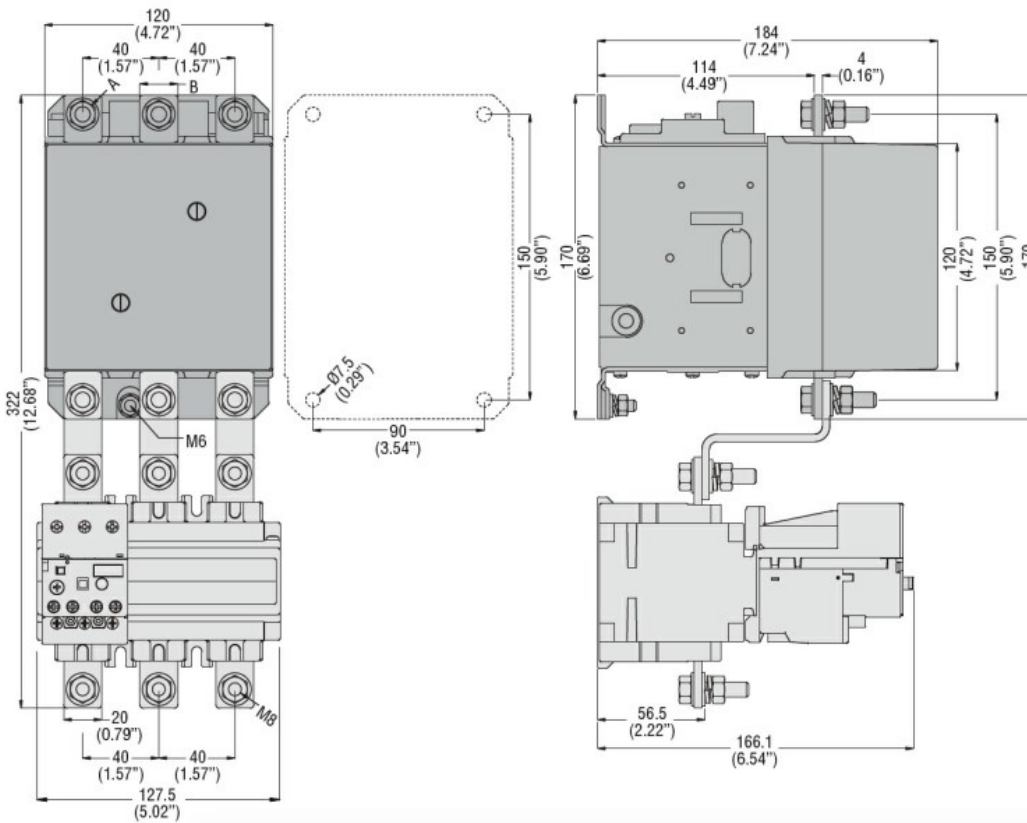

CONTACTOR TYPE	A	B
B115	M6	15 (0.59")
B145	M8	20 (0.79")
B180	M8	20 (0.79")

Wiring diagrams

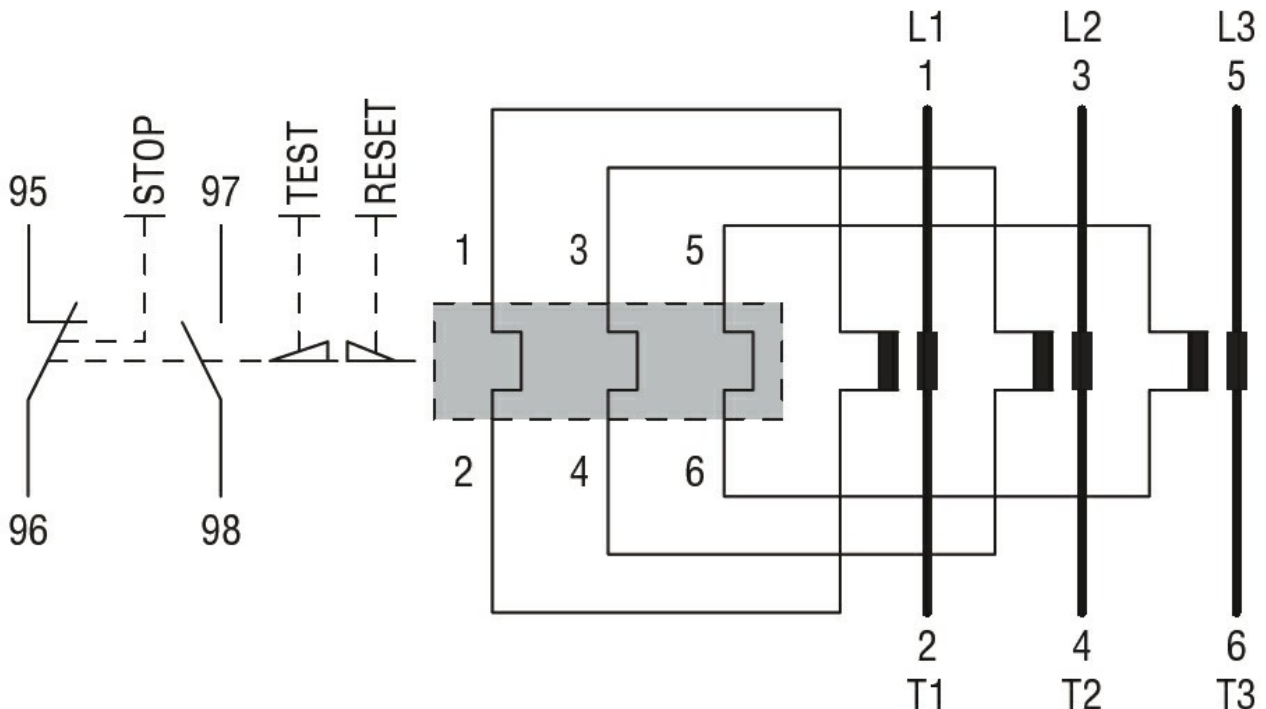

Certifications and compliance

Compliance

CSA C22.2 n° 14

IEC/EN 60947-1

IEC/EN 60947-4-1

UL508

Certifications

cULus

EAC

ETIM classification

ETIM 8.0

EC000106 -
Thermal overload
relay