

METAL PUSHBUTTONS AND SELECTOR SWITCHES

Flush pushbutton with contact or lamp-holder elements (direct or resistor-diode type) or test element

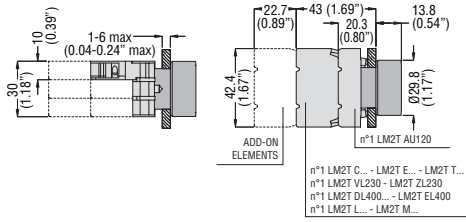

Flush pushbutton with Faston contact elements

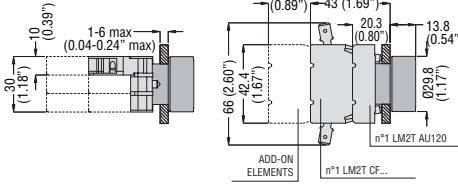

Drillings - Minimum recommended distances

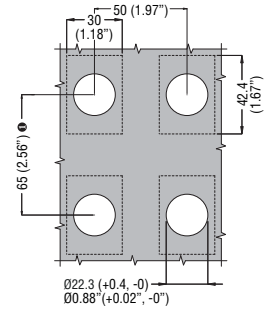

1 When Faston contacts are used, the vertical pitch must be 90mm (3.54") minimum.

Pushbutton actuators

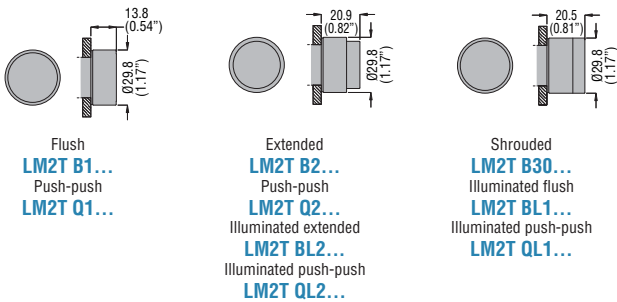

Reset button (complete unit)

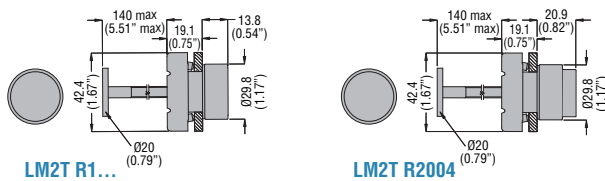

Mushroom-head button actuators

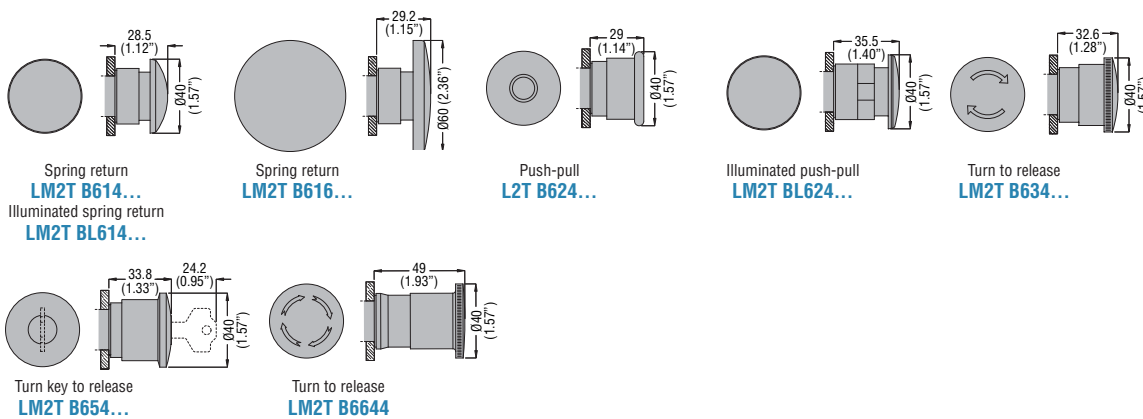

Double-touch actuators with or without indicator 2 flush buttons

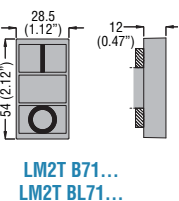

Double-touch actuators with or without indicator 1 flush and 1 extended buttons

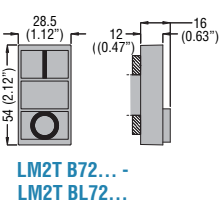

Triple-touch actuators with middle extended button

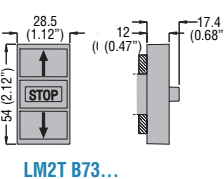

Drillings - Minimum recommended distances

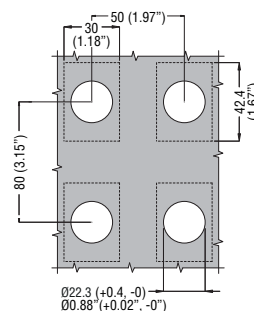

Selector switch actuators

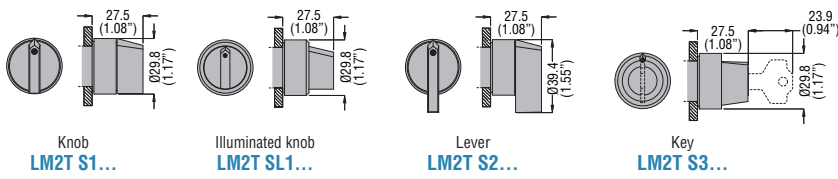

Pilot light head

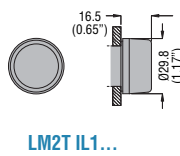

Potentiometer drive

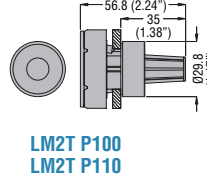

Joystick with free actuation lever

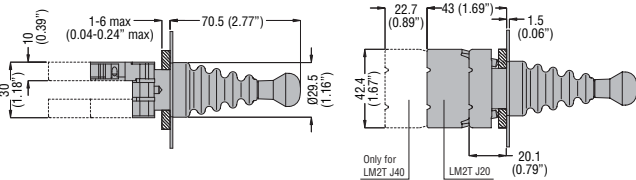

Joystick with mechanical latch lever

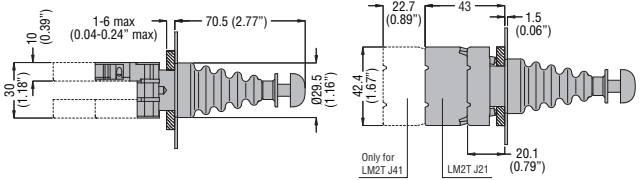

7

LM2T J20... - LM2T J40...

LM2T J21... - LM2T J41...

Label holder

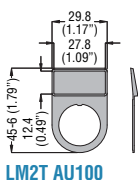

LM2T AU100

Label

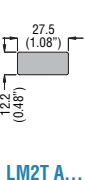

LM2T A...

Label holder

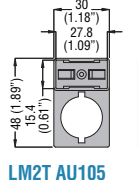

LM2T AU105

Label

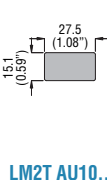

LM2T AU10...

Plastic disk for mushroom-head pushbuttons

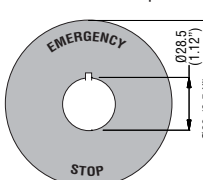

LM2T AU113

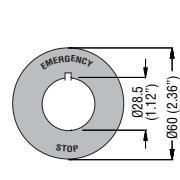

LM2T AU115
LM2T AU118

IP66 boot for flush and illuminated flush buttons

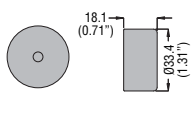

LM2T AU13...

IP66 boot for extended and illuminated extended buttons

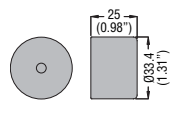

LM2T AU14...

IP66 boot for double/triple touch buttons

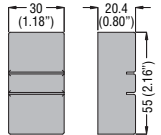

LM2T AU157

IP66 boot for mushroom-head buttons

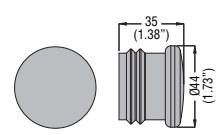

LM2T AU167

Threaded plug for unused drilled holes

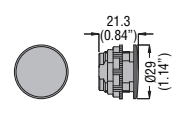

LM2T A130

Knob selector switch protection

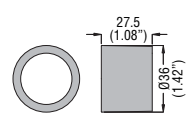

LM2T AU185

Lamp-holder elements with direct supply or resistor and diode

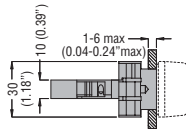

LM2T EL400
LM2T DL400
LM2T ZL230
LM2T VL230

LED steady or flashing light element

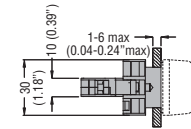

LM2T L... - LM2T M...

Transformer or flashing lamp holder element

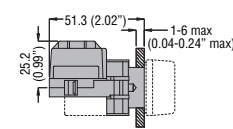

LM2T YL... - LM2T GL...
LM2T XL... - LM2T FL...