

PLATINUM SERIES PUSHBUTTONS AND SELECTOR SWITCHES

Flush pushbutton with screw terminal contact or LED or test elements

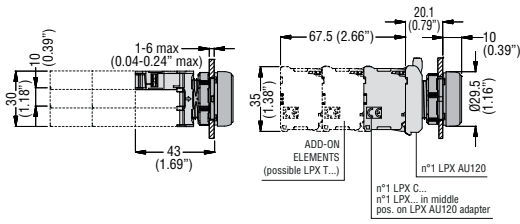

Flush pushbutton with Faston contact elements

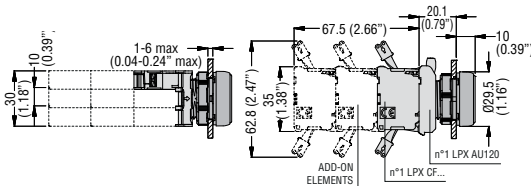

Drillings - Minimum recommended distances

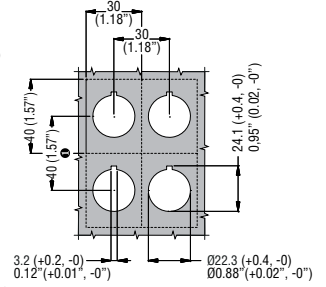

① When Faston contacts are used, the vertical pitch must be 85mm (3.35") minimum.

7

Mushroom-head pushbutton with auto-monitor contacts

LPX C01SM

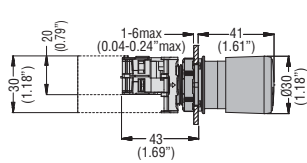

LPX C02SM

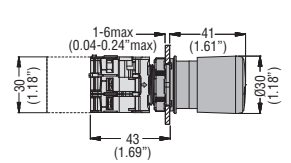

Flush pushbutton with test element and spring-clamp terminal contact or LED elements LPX CS... - LPX LPS...

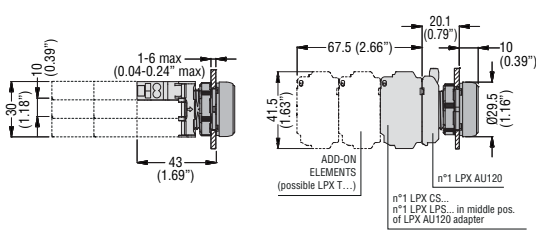

Drillings - Minimum recommended distances with spring-clamp terminal contact or LED elements

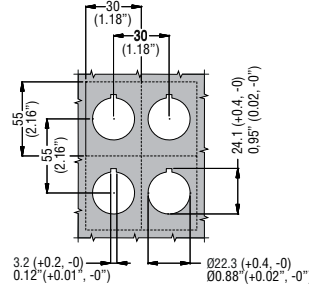

Pushbutton actuators

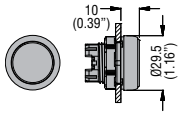

Flush
LPC B1...
Illuminated flush
LPC BL1...
LPC B0

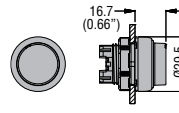

Push-push
LPC Q1...
LPC Q0
Illuminated push-push
LPC QL1...

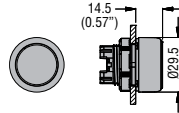

Shrouded
LPC B30...
LPC B3

② Complete with cap or lens.

Reset button (complete unit)

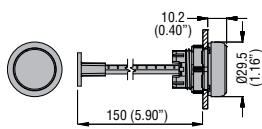

Flush
LPC R1...

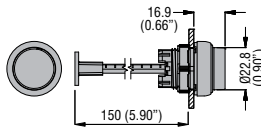

Extended
LPC R2004

Mushroom-head button actuators

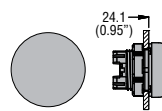

Spring return
LPC B614...
Illuminated spring return
LPC BL614...

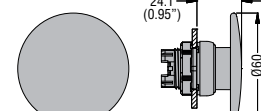

Spring return
LPC B616...

Mushroom-head latch button actuators

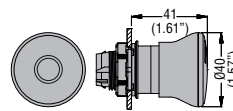

Push-pull
LPC B674...

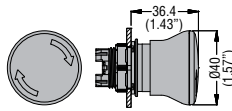

Turn to release
LPC B634...

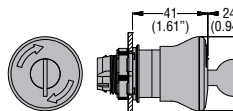

Turn key to release
LPC B684...

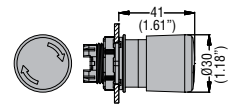

Turn to release
LPC B6634

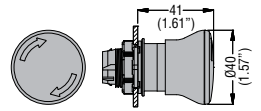

Turn to release
LPC B6644
Illuminated turn to release
LPC BL6644...

Selector switch actuators

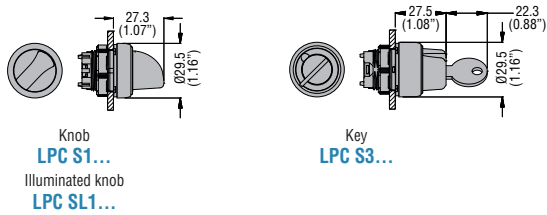

Double-touch actuators with or without indicator 2 flush buttons

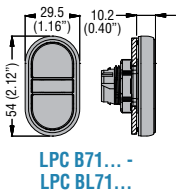

Double-touch actuators with or without indicator 1 flush and 1 extended buttons

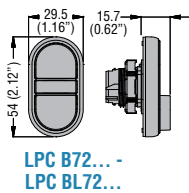

Triple-touch actuators with middle extended button

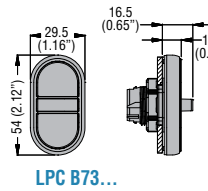

Drillings - Minimum recommended distances

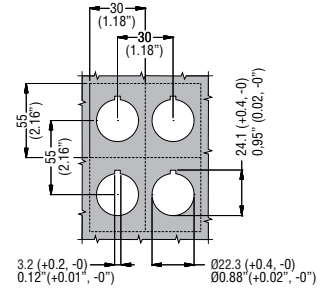

Pilot light head

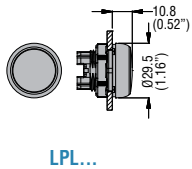

LED-integrated monoblock pilot lights - steady light

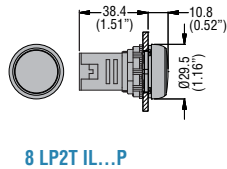

Monoblock buzzers

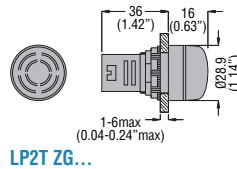

Interface connectors

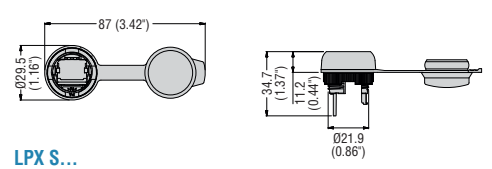

Threaded plug for unused drilled holes

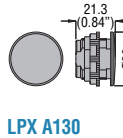

Knob selector switch protection

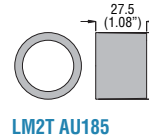

Label holder

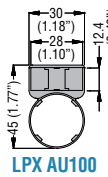

Label

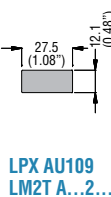

Label holder

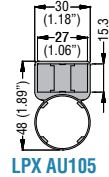

Label

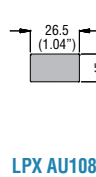

Plastick disk for mushroom-head pushbuttons

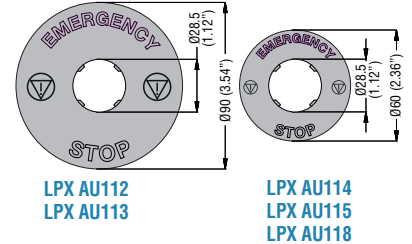

Rubber boot for flush buttons

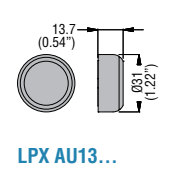

Rubber boot for extended buttons

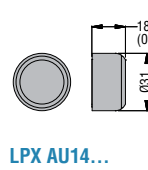

Double/triple button boot

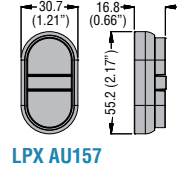

Rubber boot for mushroom-head buttons

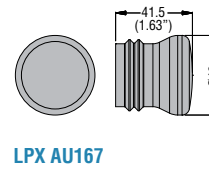

Padlockable protection for mushroom-head latch buttons except LPC B634...

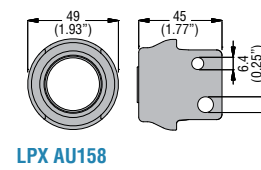

Cable gland

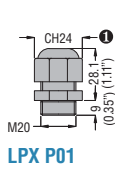

CONTROL STATIONS WITHOUT ACTUATORS

LPZ P1 A8

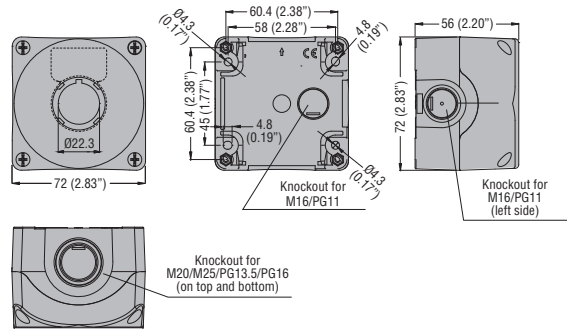

LPZ P2 A8

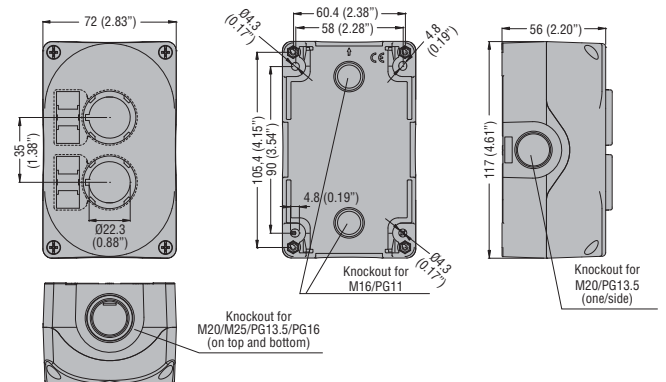

① CH24 = Spanner/Wrench size 24