

PRODUCT INFORMATION PACKET

Model No: 056C34F5308
Catalog No: G352
3/4,3450,TEFC,56,1/60/115-208/230
Totally Enclosed Fan Cooled (TEFC)



Regal and Marathon are trademarks of Regal Beloit Corporation or one of its affiliated companies.
©2018 Regal Beloit Corporation, All Rights Reserved. MC017097E





Nameplate Specifications

Output HP	0.75 Hp	Output KW	0.56 kW
Frequency	60 Hz	Voltage	115/208-230 V
Current	10.6/5.3-5.3 A	Speed	3450 rpm
Service Factor	1.15	Phase	1
Efficiency	66 %	Duty	Continuous
Insulation Class	B	Design Code	N
KVA Code	M	Frame	56
Enclosure	Totally Enclosed Fan Cooled	Overload Protector	No
Ambient Temperature	40 °C	Drive End Bearing Size	6203
Opp Drive End Bearing Size	6203	UL	Recognized
CSA	Y	CE	N
IP Code	43		

Technical Specifications

Electrical Type	Capacitor Start Induction Run	Starting Method	Across The Line
Poles	2	Rotation	Selective Counterclockwise
Mounting	Rigid base	Motor Orientation	Horizontal
Drive End Bearing	Ball	Opp Drive End Bearing	Ball
Frame Material	Rolled Steel	Shaft Type	NEMA 56
Overall Length	12.32 in	Shaft Diameter	0.625 in
Shaft Extension	1.88 in	Assembly/Box Mounting	F1 Only
Outline Drawing	A-100093-706	Connection Diagram	102005-51

This is an uncontrolled document once printed or downloaded and is subject to change without notice. Date Created: 07/02/2018

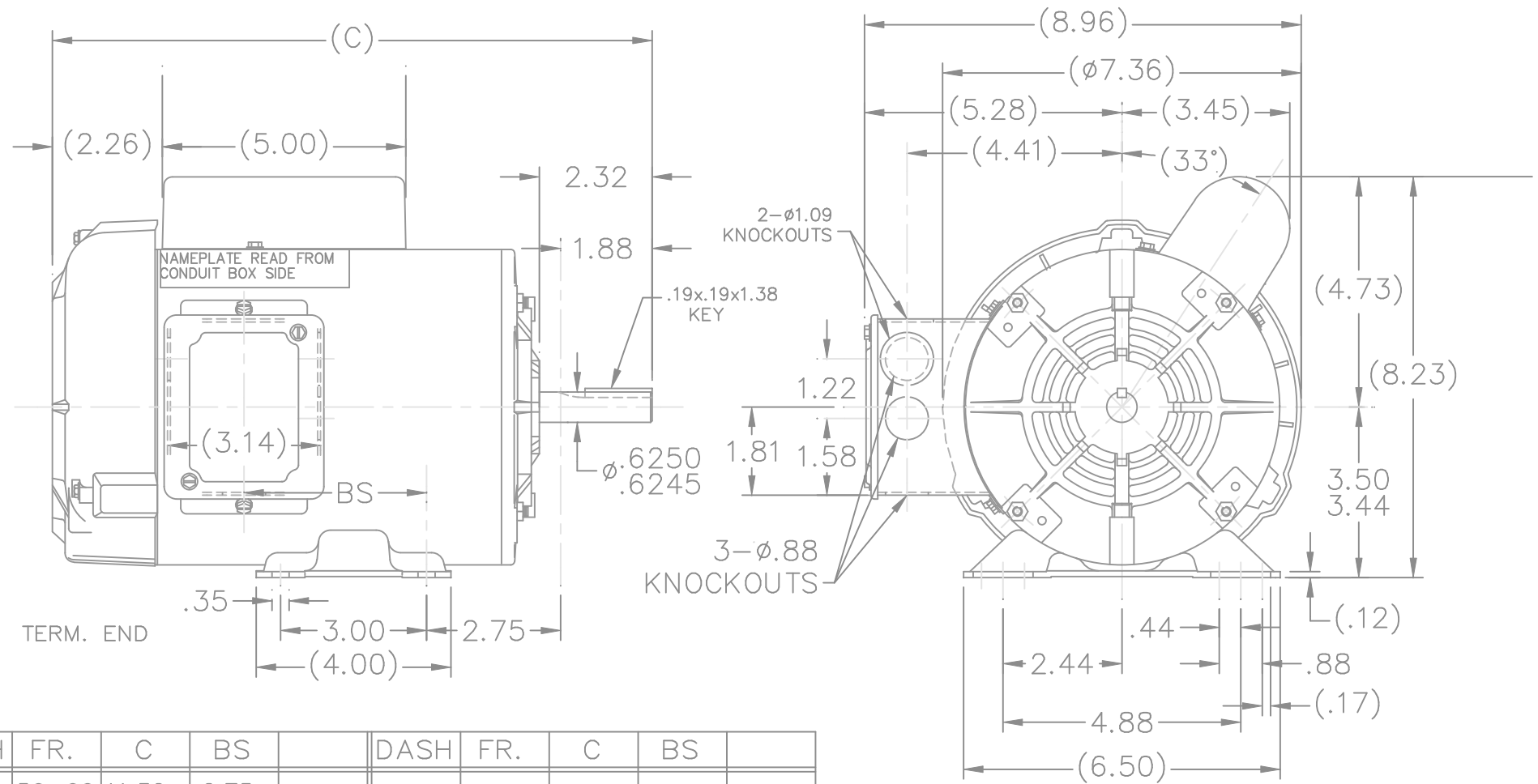

DASH	FR.	C	BS		DASH	FR.	C	BS	
606	56-60	11.32	2.75						
656	56-65	11.82	3.25						
706	56-70	12.32	3.75						
756	56-75	12.82	4.25						

NOTE:
CONDUIT BOX CAN BE ROTATED IN 180° STEPS

				TOLERANCES UNLESS SPECIFIED		 MARATHON ELECTRIC	DRAWN SC 08-06-1990				
				DEC.	INCHES		CHK ML 08-06-1990				
				.X	±.1		APPD GK 08-06-1990				
				.XX	±.03		SCALE 5=16				
				.XXX	±.005		REF				
2	REDRAWN ON CAD		SC 08-06-1990	.XXXX	±.0005	TITLE OUTLINE 56 FR. - BB - TEFC - 1ø	MAT'L.				
NO.	REVISION		BY & DATE	CHK	ANG ±7'30"	FINISH	PREV				
THIS DRAWING IN DESIGN AND DETAIL IS OUR PROPERTY AND MUST NOT BE USED EXCEPT IN CONNECTION WITH OUR WORK ALL RIGHTS OF DESIGN AND INVENTION ARE RESERVED THIS IS AN ELECTRONICALLY GENERATED DOCUMENT - DO NOT SCALE THIS PRINT				RFP		CAD FILE 100093	SIZE	DRAWING NO.	PAGE	OF	REV.
				DIST	WP		A	100093			2

LOW VOLTAGE - C.C.W.

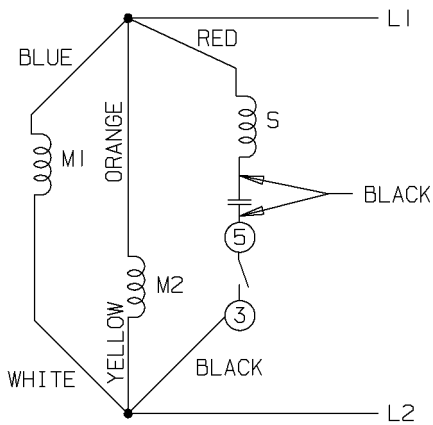

HIGH VOLTAGE - C.C.W.

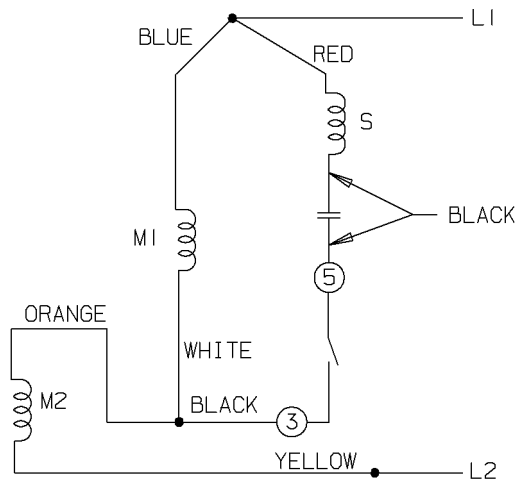

A-102005-51

DUAL VOLTAGE
CAPACITOR START NO
OVERLOAD SELECT ROTATION

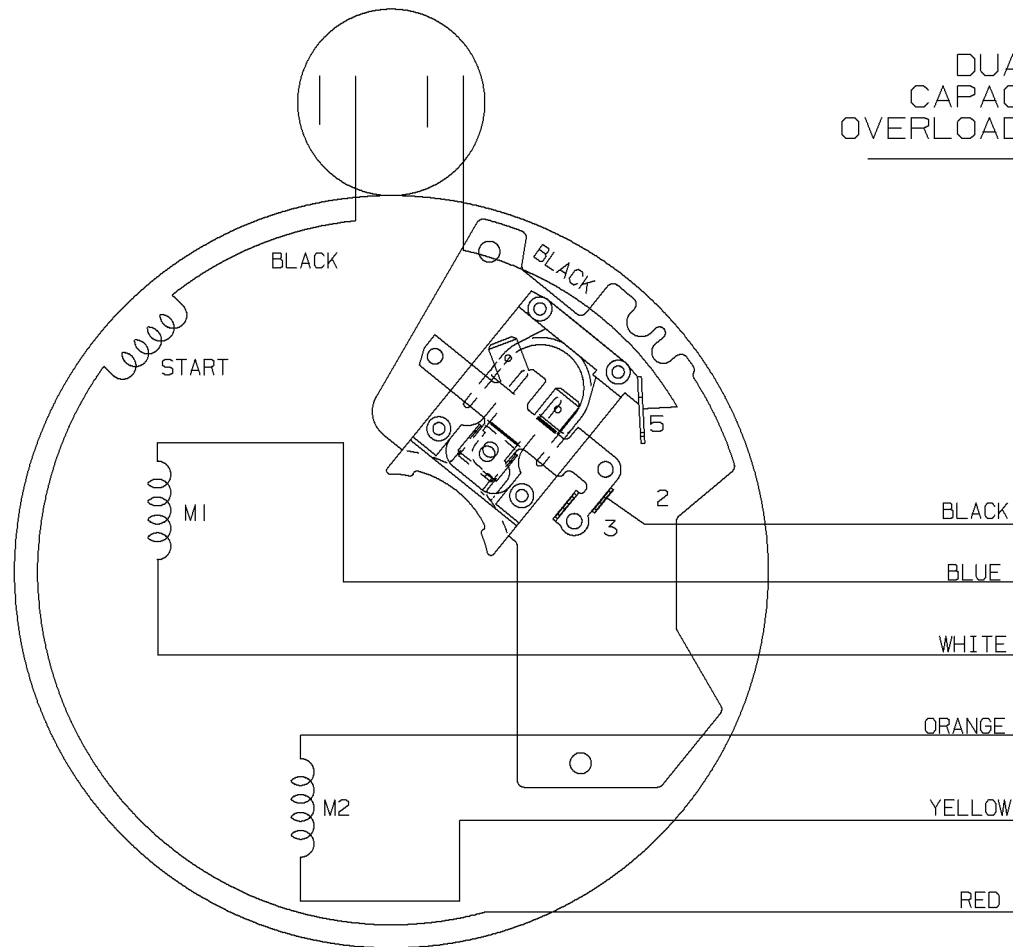

LOW VOLT. - C.C.W. ROT.

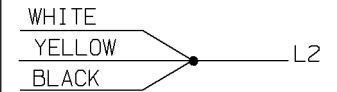
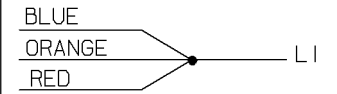

HIGH VOLT. - C.C.W. ROT.

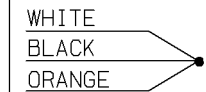
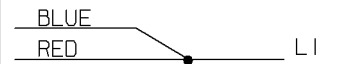

FOR C.W. ROTATION EITHER
VOLTAGE INTERCHANGE
RED WITH BLACK LEAD

				✓ MAX. SURFACE ROUGHNESS UNLESS NOTED OTHERWISE	UNLESS OTHERWISE SPECIFIED DIMENSIONS ARE IN INCHES TOL. ON XX± XXX±.005 XXXX±.0005 ANGLES±		
				MATL SPEC			DRAWN BY CAV 06-18-1999
				FINISH			CHKD BY ML 06-18-1999
5	06-17-1999	REDRAWN	CAV	REFERENCE DRW.	MARATHON ELECTRIC WAUSAU, WISCONSIN 54401		APPD BY GK 06-18-1999
REV	DATE	CHANGE	NAME	PART NAME CONNECTION DIAGRAM			DRWG NO A-102005-51

SHOP BOOK

PURCHASED

DISTRIBUTION - WA - LB - WP - LM - BR

CADD FILE NO.

102005-51

```
ERROR: syntaxerror  
OFFENDING COMMAND: --nostringval--
```

```
STACK:
```

```
/p2e  
-savelevel-
```

