

SPeX

Hazardous Location Single Pole Plug and Receptacle



Main Advantages

- ▶ Mechanical keying system prevents intermating of phases
- ▶ Reliable mechanical and Electrical interlocking
- ▶ Automatic IP65/IP66 when plug is mated



- ▶ Features & Ratings p. 230
- ▶ SPeX p. 231
- ▶ Dimensions p. 232

PRODUCT FEATURES



Hazardous location rating is based on mandatory use of pilot circuit to make and break load on phase contacts.



Operating Instructions



To connect, insert the plug into the receptacle until a click is heard. Rotation of the plug in either direction engages a locking finger, which prevents further rotation.



To close the pilot circuit and mechanically lock the plug into the receptacle, turn the ring on the receptacle until the "1" lines up with the arrow. This turns the power on.



To disconnect, open the pilot circuit and unlock the plug by turning the ring until the "0" is aligned with the arrow. The power is now off.



Press firmly on the latch release button and simultaneously pull on the inlet. A slight rotation of the plug may also be required.

Hazardous Location Listings (CSA or ATEX)

CSA	ATEX
Class I, Division 2, Group ABCD	II2 G D Ex e IIC T* Gb Ex tIIIC T* Db IP65/IP66
Class II, Division 1 Groups EFG; Class III, Division 1	Suitable for Zone 1 & 2 (gas) 21 & 22 (dust)
Ex e IIC; Ex tb IIIC T56°C or T76°; IP66 (For Canada)	-20°C ≤ Ta ≤ 40°C T5 T56°C
Class I, Zone 1, AEx e IIC T5 or T6	-20°C ≤ Ta ≤ 60°C T5 T76°C
AEx tb IIIC T56°C or T76°C	-20°C ≤ Ta ≤ 40°C T6 T56°C
IP65/IP66 (For US)	-20°C ≤ Ta ≤ +60°C T4 T79°C

Amperage Ratings by Cable Size and ATEX Rating

	-20°C ≤ Ta ≤ 40°C	-20°C ≤ Ta ≤ 40°C	-20°C ≤ Ta ≤ 60°C
	G/D T5/T56°C	G/D T6/T56°C	G/D T5/T76°C
70mm ²	290 A	235 A	235 A
95mm ²	415 A	335 A	335 A
120mm ²	456 A	376 A	376 A
150mm ²	493 A	415 A	415 A
185mm ²	530 A	450 A	450 A
240mm ²	570 A	497 A	497 A
300mm ²	620 A	540 A	540 A
400mm ²	680 A	600 A	600 A

HAZARDOUS LOCATION

SPeX Hazardous Location Plugs & Receptacles

Devices rated for hazardous locations are not returnable.

cCSAus Ratings

- **Voltage**
600 VAC
- **Amperage Ratings**
600 A
- **Environmental Ratings**
IP65/IP66
- **Temperature Range**
See table page 230
- **Wiring Capacity**
Min 2/0 AWG Max 750 MCM
Aux Contacts 12-14 AWG
See table page 230
- **Applicable Standards**
CSA C22.2 No. 182.1,
CSA 213-M1987, CSA 25-1966

Plug
(Male inlet w/handle)



Receptacle on angle
(Female)



North American cCSAus Configurations

Color Code	Polarity	Part # without Lug (by cable diameter)				Part # without Lug
		.70 - .98"	.94 - 1.33"	1.33 - 1.65"	1.57 - 1.89"	
	L1	42-41001-32P	42-41001-40P	42-41001-50P	42-41001-63P	42-47001
	L2	42-41002-32P	42-41002-40P	42-41002-50P	42-41002-63P	42-47002
	L3	42-41003-32P	42-41003-40P	42-41003-50P	42-41003-63P	42-47003
	NEUTRAL	42-4100N-32P	42-4100N-40P	42-4100N-50P	42-4100N-63P	42-4700N
	GROUND	42-4100T-32P	42-4100T-40P	42-4100T-50P	42-4100T-63P	42-4700T
	POSITIVE	42-4100P-32P	42-4100P-40P	42-4100P-50P	42-4100P-63P	42-4700M
	NEGATIVE	42-4100M-32P	42-4100M-40P	42-4100M-50P	42-4100M-63P	42-4700P

IEC/CE Ratings

- **Voltage**
1000 VAC, 1500 VDC
- **Amperage Ratings**
See table page 230
- **Environmental Ratings**
IP65/ IP66
- **Temperature Range**
See table page 230
- **Wiring Capacity**
Min 2/0 AWG Max 750 MCM
Aux Contacts 12-14 AWG
See table page 228
- **Applicable Standards**
ATEX, IECEx

Plug
(Male inlet w/handle)



Receptacle on angle
(Female)



IEC/CE Configurations

Color Code	Polarity	Part # without Lug (by cable diameter)				Part # without Lug
		.70 - .98"	.94 - 1.33"	1.33 - 1.65"	1.57 - 1.89"	
	L1	46-41001-32P	46-41001-40P	46-41001-50P	46-41001-63P	46-47001
	L2	46-41002-32P	46-41002-40P	46-41002-50P	46-41002-63P	46-47002
	L3	46-41003-32P	46-41003-40P	46-41003-50P	46-41003-63P	46-47003
	NEUTRAL	46-4100N-32P	46-4100N-40P	46-4100N-50P	46-4100N-63P	46-4700N
	GROUND	46-4100T-32P	46-4100T-40P	46-4100T-50P	46-4100T-63P	46-4700T
	POSITIVE	46-4100P-32P	46-4100P-40P	46-4100P-50P	46-4100P-63P	46-4700P
	NEGATIVE	46-4100M-32P	46-4100M-40P	46-4100M-50P	46-4100M-63P	46-4700M

INSTALLATION ACCESSORIES

Accessories rated for hazardous locations are not returnable.



(Bolt Included)

WIRE CAPACITY

CRIMPING LUGS

Internal Diameter		Straight w/terminal	Straight Threaded	Flexible Wiring*		Course Wiring	
in	mm	Part #	Part #	mm ²	AWG	mm ²	AWG
.43	11	45-4A50C	45-4A50D	50	1/0	70	2/0
.51	13.1	45-4A70C	45-4A70D	70	2/0	95	3/0
.57	14.5	45-4A95C	45-4A95D	95	3/0	120	4/0
.64	16.2	45-4A12C	45-4A12D	120	250	150	300
.71	18	45-4A15C	45-4A15D	150	300	185	400
.81	20.6	45-4A18C	45-4A18D	185	350	240	450
.91	23.1	45-4A24C	45-4A24D	240	450	300	500
1.03	26.1	45-4A30C	45-4A30D	300	600	400	750
1.15	29.2	45-4A40C	45-4A40D	400	750, 777	500	800

Notes: * Class H & I

ACCESSORIES

DRAWBAR	Part #
	45-4A376

Dimensions Inlet/Receptacle – Provided in inches

Dimensions are for reference only and may change depending on accessories used. For precise dimensions contact MELTRIC Engineering.

inlet

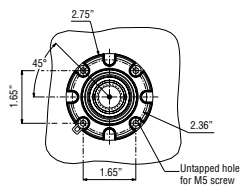

receptacle

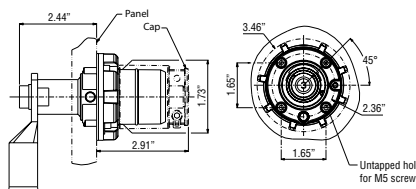

plug

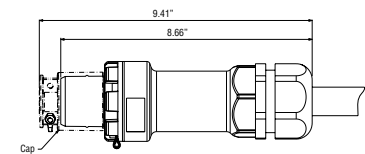

connector

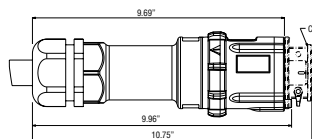

plug/connector

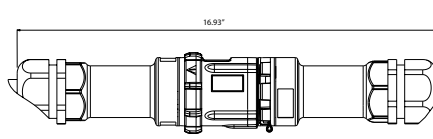

plug with connector on/off

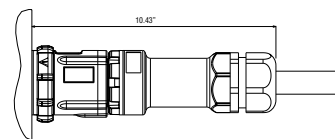

connector with plug on/off

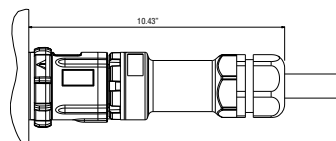

45° inclined receptacle/angle with plug

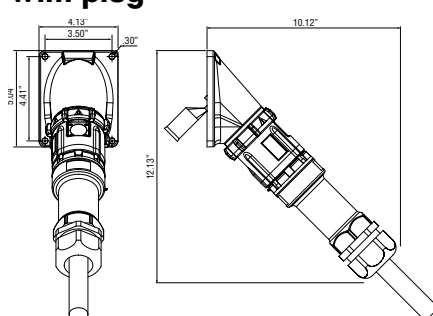

45° inclined inlet/angle with connector

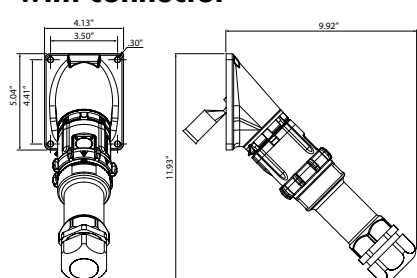

HAZARDOUS LOCATION