

MEF EMC-FILTER 3-PHASE 1-STAGE WITH NEUTRAL

I:6A U:4x440 VAC snap on

Current: 6 A
DIN-rail mountable
with neutral
Attenuation curves on request.

Illustration

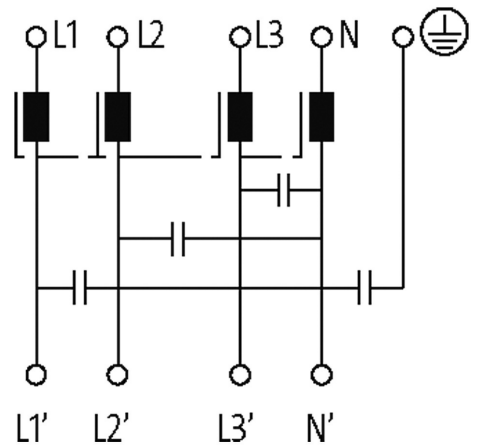
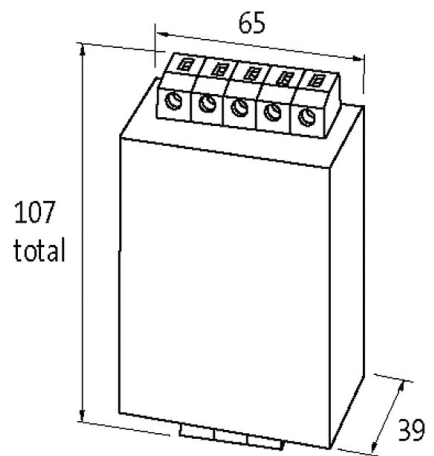

Product may differ from Image

Approvals



General data

Climatic category	25/085/21 (EN 60068-1)
Test isolation voltage	2.7 kV (L - N), 2 s; 2.1 kV (L - L), 2 s (EN 60939-2)
Connection	Screw connection, touch protected

Mounting method	DIN-rail mountable TH35 (EN 60715)
Dimensions H×W×D	107×65×39 mm

Technical Data

Operating voltage	max. 3× 440 V AC
Operating frequency	50...60 Hz
Overload current	18× (IN t) max. 0.5 ms; 1.5× (IN t) max. 1 min. (1× per hour)
Consumption	max. 3 mA (250 V AC)
Connection cross section	0.2...6 mm ² single core (AWG 24...9); 0.2...4 mm ² multiple core (AWG 24...11)

Description

Functional description	The 3-phase and one-stage EMC filters MEF 3/1 are used in the range 0.1...30 MHz and dampen interferences found in cables from the mains, supply units and control systems. They are suitable for TN-S, TN-C-S, and TT networks. The best results are obtained
------------------------	--

Commercial data

country of origin	IT
customs tariff number	85363010
EAN	4048879029285
eClass	27130806
Packaging unit	1