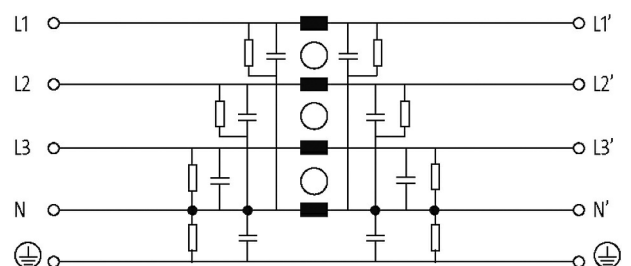
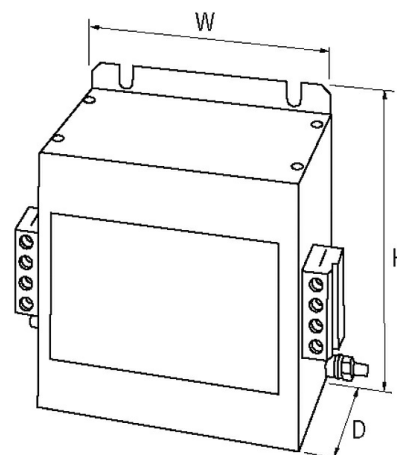

MEF EMC-FILTER 3-PHASE 1-STAGE WITH NEUTRAL

I:36A U:4x500 VAC

Current: 36 A
with neutral
with increased damping
Attenuation curves on request.

Illustration

Product may differ from Image

Approvals



General data

Mounting method	screw fixing
Dimensions H×W×D	153×130×100 mm
Climatic category	25/085/21 (EN 60068-1)
Test isolation voltage	3.3 kV (L-N), 2 s; 3.1 kV (L-L), 2 s

Technical Data

Connection cross section	0.2...10 mm ² single core (AWG 24...7); 0.2...6 mm ² multiple core (AWG 24...9)
Operating voltage	max. 3× 500 V AC
Operating frequency	50...60 Hz
Consumption	max. 15 mA (250 V AC)
Overload current	18× (IN t) max. 0.5 ms; 1.5× (IN t) max. 1 min. (1× per hour)

Description

Functional description	The 3-phase and one-stage EMC filters MEF 3/1 are used in the range 0.1...30 MHz and dampen interferences found in cables from the mains, supply units and control systems. They are suitable for TN-S, TN-C-S, and TT networks. The best results are obtained
------------------------	--

Commercial data

country of origin	IT
customs tariff number	85363030
EAN	4048879029087
eClass	27130806
Packaging unit	1