

M12 FEMALE 90° SHIELDED

PVC 4X0.34 shielded GRAY, 20m

Female 90°

M12, 4-pole

shielded

with cable sleeves

Plastic housings with good resistance against chemicals and oils.

The resistance to aggressive media should be individually tested for your application. Further details on request.

Further cable lengths on request.

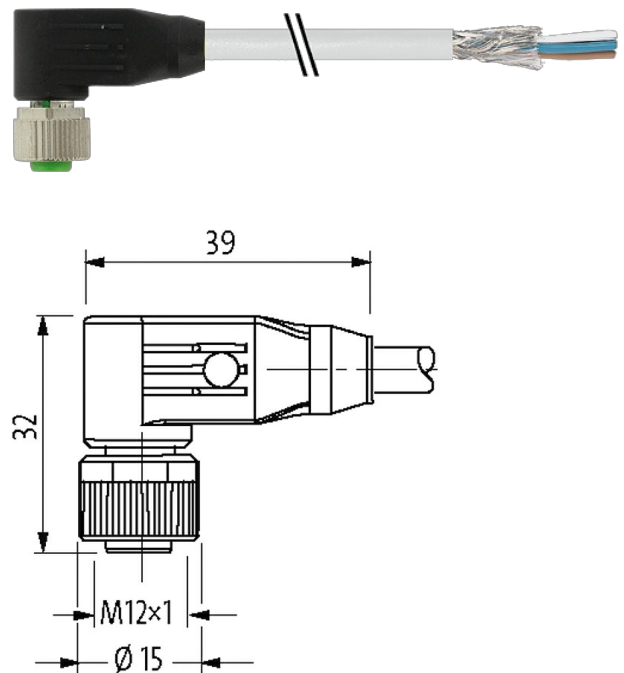
Illustration

Product may differ from Image

Approvals

cCSAus

* only for products with UL/CSA approved cable

EAC

Form

Form 13261

Cables

Cable number	330
No./diameter of wires	4 x 0.34 mm ²
Wire isolation	PVC (br, wh, bl, bk)
Jacket Color	gray
Material (jacket)	PVC
Outer Ø	5.9 mm ±5%
Bend radius (fixed)	5 x outer Ø
Bend radius (moving)	15 x outer Ø

Temperature range (fixed)	-25...+80 °C
Temperature range (mobile)	-5...+70 °C
Shield	yes
Color (jacket)	gray
Approval (cable)	CE conform

Technical Data

Operating voltage	max. 60 V AC/DC
Operating voltage (only UL listed)	max. 30 V AC/DC
Operating current per contact	max. 4 A
Rated surge voltage	1.5 kV
Material group	IEC 60664-1, category I
Coding	A-coded
Locking of ports	Screw thread (M12×1 mm) recommended torque 0.6 Nm, self-securing
Compression gland	M12 (SW13)
Protection	IP65, IP66K, IP67 inserted and tightened (EN 60529)
Locking material	Zinc die casting, matte nickel plated
Material	PUR

General data

Standards	DIN EN 61076-2-101 (M12)
Pollution Degree	3
Temperature range	-25...+85 °C, depending on cable quality

Commercial data

country of origin	DE
customs tariff number	85444290
EAN	4048879199223
eClass	27279218
Packaging unit	1

Sketch

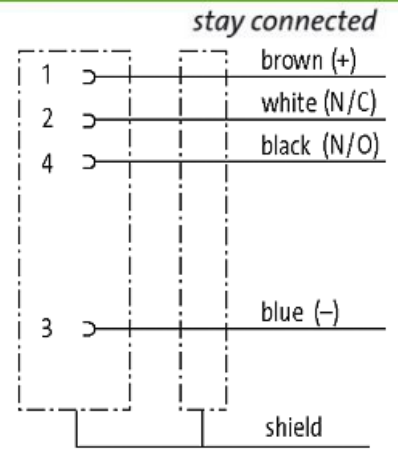

Female

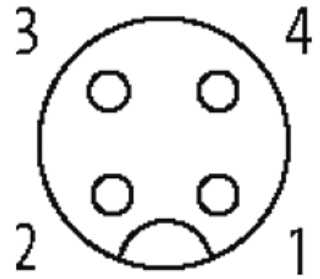

Product may differ from Image