

**M12 FEMALE 90° SHIELDED**

PVC 4X0.34 shielded GRAY, 25m

Female 90°

M12, 4-pole

shielded

with cable sleeves

Plastic housings with good resistance against chemicals and oils.

The resistance to aggressive media should be individually tested for your application. Further details on request.

Further cable lengths on request.

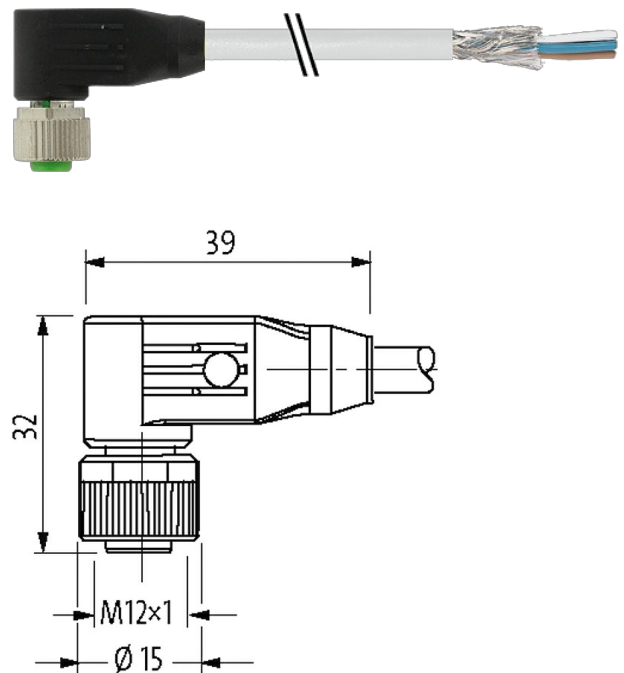
**Illustration**

Product may differ from Image

**Approvals**

cCSAus

\* only for products with UL/CSA approved cable

EAC

**Form**

Form 13261

**Cables**

Cable number	330
No./diameter of wires	4 x 0.34 mm <sup>2</sup>
Wire isolation	PVC (br, wh, bl, bk)
Jacket Color	gray
Material (jacket)	PVC
Outer Ø	5.9 mm ±5%
Bend radius (fixed)	5 x outer Ø
Bend radius (moving)	15 x outer Ø

Temperature range (fixed)	-25...+80 °C
Temperature range (mobile)	-5...+70 °C
Shield	yes
Color (jacket)	gray
Approval (cable)	CE conform

**Technical Data**

Operating voltage	max. 60 V AC/DC
Operating voltage (only UL listed)	max. 30 V AC/DC
Operating current per contact	max. 4 A
Rated surge voltage	1.5 kV
Material group	IEC 60664-1, category I
Coding	A-coded
Locking of ports	Screw thread (M12×1 mm) recommended torque 0.6 Nm, self-securing
Compression gland	M12 (SW13)
Protection	IP65, IP66K, IP67 inserted and tightened (EN 60529)
Locking material	Zinc die casting, matte nickel plated
Material	PUR

**General data**

Standards	DIN EN 61076-2-101 (M12)
Pollution Degree	3
Temperature range	-25...+85 °C, depending on cable quality

**Commercial data**

country of origin	DE
customs tariff number	85444290
EAN	4048879199216
eClass	27279218
Packaging unit	1

**Sketch**

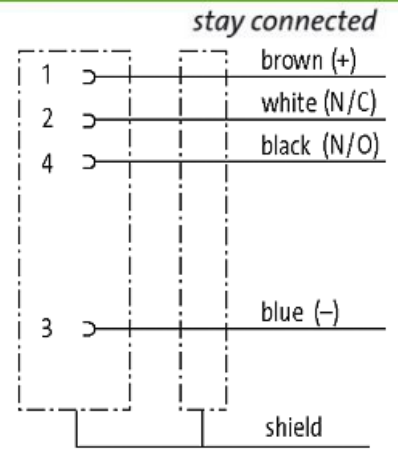

Female

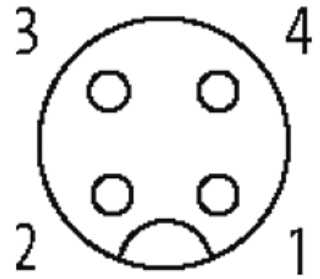

Product may differ from Image