

M12 male 0° shielded B-cod. with cable

PUR AWG24+AWG22 shielded vt UL/CSA+drag ch. 6m

Male straight

M12, 4-pole

B-coded

shielded

Plastic housings with good resistance against chemicals and oils.

The resistance to aggressive media should be individually tested for your application. Further details on request.

Further cable lengths on request.

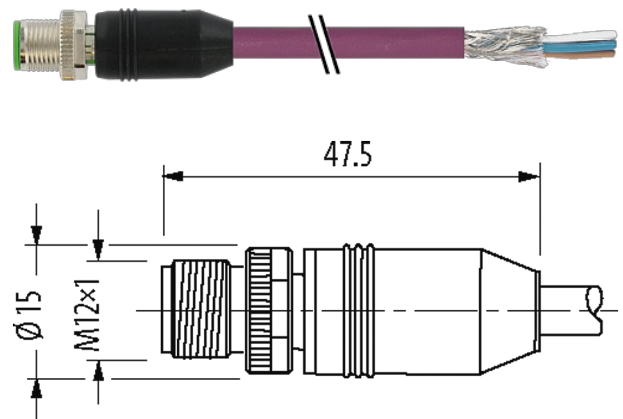
Illustration

Product may differ from Image

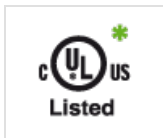
Approvals

cCSAus

* only for products with UL/CSA approved cable

EAC

Form

Form 14052

Cables

No./diameter of wires	2 × 0.25 + 2 × 0.34 mm ²
Wire isolation	PE (rd, bk), (bl, wh)
Material (jacket)	PUR (UL/CSA)
Outer Ø	6.9 mm ±5%
Bend radius (moving)	10 × outer Ø
Temperature range (fixed)	-40...+80 °C
Temperature range (mobile)	-30...+70 °C
Cable identification	803
Approval (cable)	UL (AWM-Style 20233/10578), CSA; CE
Cable weight [g/m]	63,12
Material (wire)	Cu wire, tin plated
Resistor (core)	max. 78 Ω/km (data pair, max. 54 Ω/km (power pair); (20 °C)
Diameter (core)	2 × 0.25 + 2 × 0.34 mm ²
AWG	similar to AWG 24 (0.25 mm ²); similar to AWG 22 (0.34 mm ²)
Wire-Ø incl. isolation	2.1 mm ±5% (0.25 mm ²); 1.5 mm ±5% (0.34 mm ²)

Color/numbering of wires	wh, bl (data pair); bk, rd (power pair)
Shield	yes
	min. 65%
Material (jacket)	PUR
Outer-Ø (jacket)	6.9 mm ±5%
Color (jacket)	violet
chemical resistance	good resistance to oil, gasoline and chemicals
thermal resistance	flame retardant
Nominal voltage	300 V
Temperature range (fixed)	-40...+80 °C
Temperature range (mobile)	-30...+70 °C
Bend radius (fixed)	6× outer Ø
Bend radius (moving)	10× outer Ø
Traversing distance (C-track)	max. 5 m (horizontal)
Travel speed (C-track)	max. 3 m/s
Acceleration (C-track)	max. 5 m/s ²
Jacket Color	violet

Technical Data

Operating voltage	max. 60 V AC/DC
Operating voltage (only UL listed)	30V AC/DC
Rated surge voltage	1.5 kV
Operating current per contact	max. 4 A
No. of poles	4
Material group	IEC 60664-1, category I
Coding	B-coded
Locking of ports	Screw thread (M12×1 mm) recommended torque 0.6 Nm, self-securing
Compression gland	M12 (SW13)
Protection	IP65, IP66K, IP67 inserted and tightened (EN 60529)
Locking material	Zinc die casting, matte nickel plated
Material	PUR
suitable for corrugated tube (internal Ø)	without

General data

Standards	DIN EN 61076-2-101 (M12)
Pollution Degree	3
Mounting method	inserted, tightened
Stripping length (jacket)	20 mm
Temperature range	-25...+85 °C, depending on cable quality

Commercial data

country of origin	DE
customs tariff number	85444290
EAN	4048879354936
eClass	27061801
Packaging unit	1