

M12 male 0°/M12 female 0° shielded B-cod.Profibus

PUR 1x2xAWG24 shielded vt UL/CSA+dragchain 21m

PROFIBUS

Male straight – female straight

M12, 4-pole – M12, 2-pole

B-coded

shielded

Plastic housings with good resistance against chemicals and oils.

The resistance to aggressive media should be individually tested for your application. Further details on request.

Further cable lengths on request.

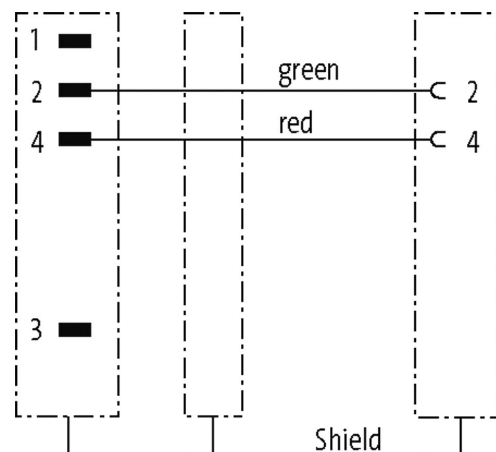
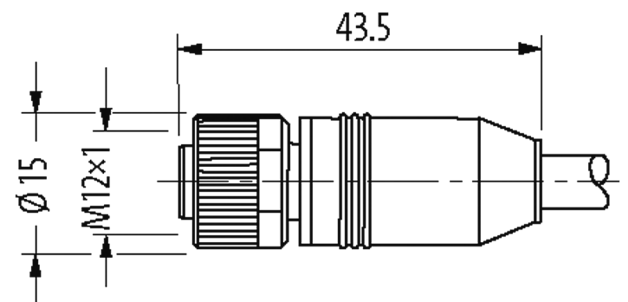
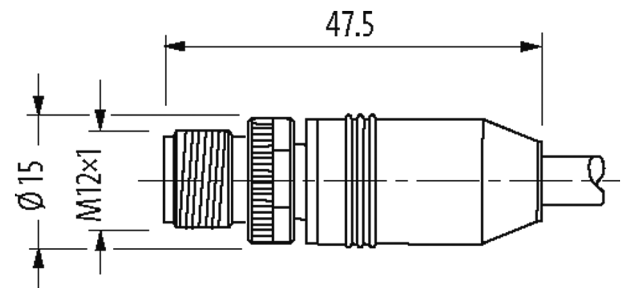
Illustration

Product may differ from Image

Approvals

cCSAus



* only for products with UL/CSA approved cable

More Info



Form

Form 44001

Cables

No./diameter of wires	1 × 2 × 0.25 mm ²
Wire isolation	PE (rd, gn)
C-track properties	10 Mio.
Jacket Color	violet
Material (jacket)	PUR (UL/CSA)
Outer Ø	7.8 mm ±5%
Bend radius (moving)	12× outer Ø
Temperature range (fixed)	-40...+80 °C
Temperature range (mobile)	-20...+60 °C
Cable identification	840
Approval (cable)	UL (AWM-Style 20236/1589), CSA; CE
Cable weight [g/m]	82,50
Material (wire)	Cu wire, bare
Resistor (core)	max. 78 Ω/km (20 °C)
Single wire Ø (core)	0.127 mm
Construction (core)	19 × 0.127 mm
Diameter (core)	1 × 2 × 0.25 mm ²
AWG	similar to AWG 24
Material (wire isolation)	PE
Wire-Ø incl. isolation	2.55 mm ±5%
Color/numbering of wires	rd, gn
Stranding combination	2 wires twisted
Shield	yes
	min. 70%
Material (jacket)	PUR
Outer-Ø (jacket)	7.8 mm ±5%
Color (jacket)	violet
chemical resistance	good resistance to oil, gasoline and chemicals
thermal resistance	flame retardant
Nominal voltage	250 V
Temperature range (fixed)	-40...+80 °C
Temperature range (mobile)	-20...+60 °C
Bend radius (fixed)	10× outer Ø
Bend radius (moving)	12× outer Ø
No. of bending cycles (C-track)	max. 10 Mio. (25 °C)
Traversing distance (C-track)	max. 5 m (horizontal)

Travel speed (C-track)	max. 3 m/s
------------------------	------------

Acceleration (C-track)	max. 5 m/s ²
------------------------	-------------------------

Technical Data

Operating voltage	max. 60 V AC/DC
-------------------	-----------------

Operating voltage (only UL listed)	max. 30 V AC/DC
------------------------------------	-----------------

Rated surge voltage	1.5 kV
---------------------	--------

Operating current per contact	max. 4 A
-------------------------------	----------

Material group	IEC 60664-1, category I
----------------	-------------------------

Coding	B-coded
--------	---------

Locking of ports	Screw thread (M12×1 mm) recommended torque 0.6 Nm, self-securing
------------------	--

Compression gland	M12 (SW13)
-------------------	------------

Protection	IP65, IP66K, IP67 inserted and tightened (EN 60529)
------------	---

Locking material	Zinc die casting, matte nickel plated
------------------	---------------------------------------

Material	PUR
----------	-----

suitable for corrugated tube (internal Ø)	without
---	---------

General data

Standards	DIN EN 61076-2-101 (M12)
-----------	--------------------------

Mounting method	inserted, tightened
-----------------	---------------------

Pollution Degree	3
------------------	---

Temperature range	-25...+85 °C, depending on cable quality
-------------------	--

Commercial data

country of origin	DE
-------------------	----

customs tariff number	85444290
-----------------------	----------

EAN	4048879142137
-----	---------------

eClass	27061801
--------	----------

Packaging unit	1
----------------	---