

M12 male 0°/M12 female 0° shielded B-cod.Profibus

PUR 1x2xAWG23 shielded vt torsion UL/CSA 15m

PROFIBUS

Male straight – female straight

M12, 4-pole – M12, 2-pole

B-coded

shielded

Plastic housings with good resistance against chemicals and oils.

The resistance to aggressive media should be individually tested for your application. Further details on request.

Further cable lengths on request.

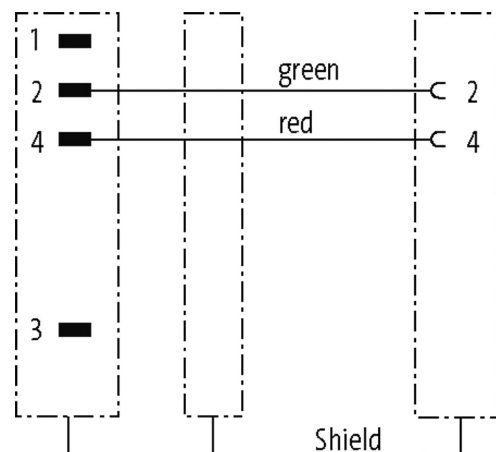
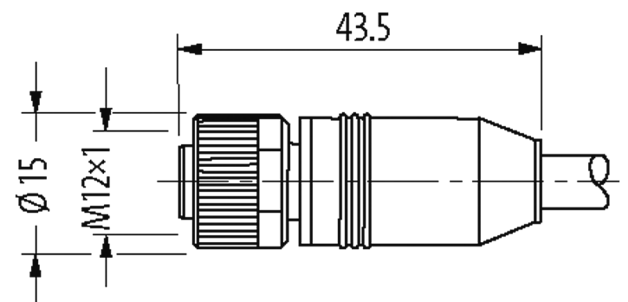
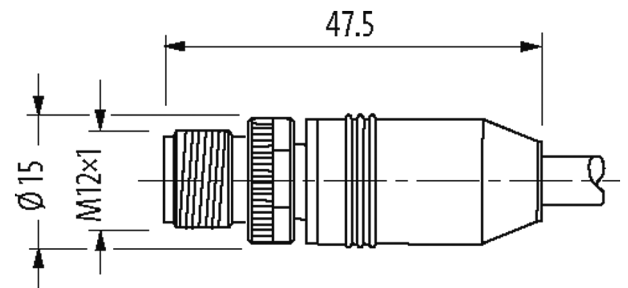
Illustration

Product may differ from Image

Approvals

cCSAus



* only for products with UL/CSA approved cable

More Info



Form

Form 44001

Cables

No./diameter of wires	1 × 2 × 0.25 mm ²
Wire isolation	PE (rd, gn)
Jacket Color	violet
Material (jacket)	PUR (UL/CSA)
Outer Ø	8.0 mm ±5%
Bend radius (moving)	12 × outer Ø
Temperature range (fixed)	-40...+80 °C
Temperature range (mobile)	-20...+50 °C
Cable identification	843
Approval (cable)	UL (AWM-Style 20233/10578), CSA; CE
Cable weight [g/m]	79,20
Material (wire)	Cu wire, bare
Resistor (core)	max. 66 Ω/km (20 °C)
Single wire Ø (core)	0.15 mm
Construction (core)	19 × 0.15 mm (multi-strand wire class 5)
Diameter (core)	1 × 2 × 0.25 mm ²
Wire-Ø incl. isolation	2.6 mm ±5%
Color/numbering of wires	rd, gn
Shield	yes
Material (jacket)	PUR
Outer-Ø (jacket)	8.0 mm ±5%
Color (jacket)	violet
thermal resistance	flame retardant
Nominal voltage	300 V
Temperature range (fixed)	-40...+80 °C
Temperature range (mobile)	-20...+50 °C
Bend radius (fixed)	8 × outer Ø
Bend radius (moving)	12 × outer Ø
Torsion stress	±180°/m

Technical Data

Operating voltage	max. 60 V AC/DC
Operating voltage (only UL listed)	max. 30 V AC/DC
Rated surge voltage	1.5 kV
Operating current per contact	max. 4 A
Material group	IEC 60664-1, category I

Coding	B-coded
Locking of ports	Screw thread (M12×1 mm) recommended torque 0.6 Nm, self-securing
Compression gland	M12 (SW13)
Protection	IP65, IP66K, IP67 inserted and tightened (EN 60529)
Locking material	Zinc die casting, matte nickel plated
Material	PUR
suitable for corrugated tube (internal Ø)	without

General data

Standards	DIN EN 61076-2-101 (M12)
Mounting method	inserted, tightened
Pollution Degree	3
Temperature range	-25...+85 °C, depending on cable quality

Commercial data

country of origin	DE
customs tariff number	85444290
EAN	4048879467742
eClass	27061801
Packaging unit	1