

M12 male 0° / M12 female, 0°, shielded, Ethernet

PUR 1x4xAWG22 shielded gn UL/CSA+robot 10m

Ethernet CAT5

Male straight – female straight

M12 – M12, 4-pole

D-coded

shielded

Further cable lengths on request.

Plastic housings with good resistance against chemicals and oils.

The resistance to aggressive media should be individually tested for your application. Further details on request.

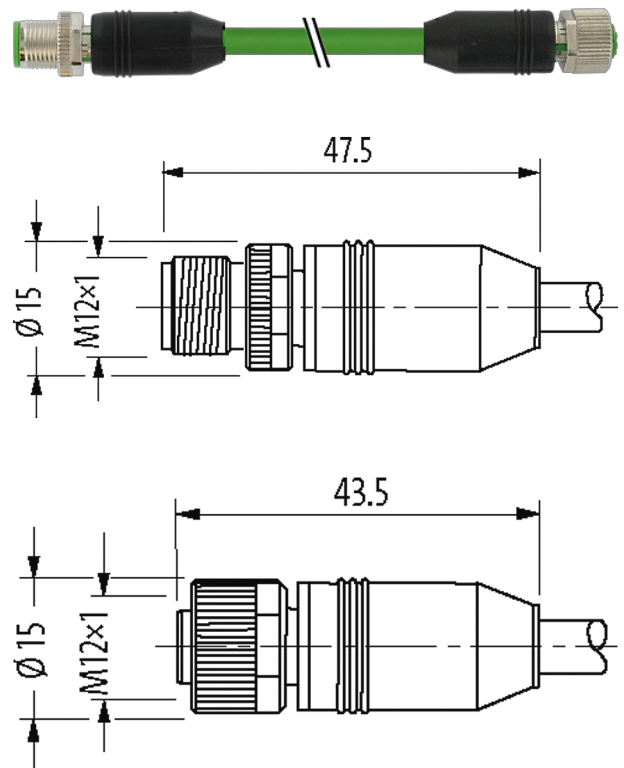
Illustration

Product may differ from Image

Approvals

* only for products with UL/CSA approved cable

More Info**Form**

Form

44571

Cables	
No./diameter of wires	1 × 4 × 0.34 mm ²
Wire isolation	PE (wh, ye, bl, or)
Material (jacket)	PUR (UL/CSA)
Outer Ø	6.6 mm ±5%
Bend radius (moving)	12 × outer Ø
Temperature range (fixed)	-40...+80 °C
Temperature range (mobile)	-20...+60 °C
Cable identification	793
Approval (cable)	UL (AWM-Style 20233/10578), CSA; CE
Cable weight [g/m]	69,30
Material (wire)	Cu wire, tin plated
Resistor (core)	max. 60 Ω/km (20 °C)
Single wire Ø (core)	0.16 mm
Construction (core)	19 × 0.160 mm
Diameter (core)	1 × 4 × AWG22/19 (0.382)
Material (wire isolation)	PE
Wire-Ø incl. isolation	1.6 mm ±5%
Color/numbering of wires	wh, ye, bl, or
Shield	yes
	min. 85%
Material (jacket)	PUR
Outer-Ø (jacket)	6.6 mm ±5%
Color (jacket)	green
chemical resistance	good resistance to oil, gasoline and chemicals
thermal resistance	flame retardant
Nominal voltage	300 V
Temperature range (fixed)	-40...+80 °C
Temperature range (mobile)	-20...+60 °C
Bend radius (fixed)	8 × outer Ø
Bend radius (moving)	12 × outer Ø
Torsion stress	±180°/m
No. of torsion cycles	max. 4 Mio. (25 °C)
Jacket Color	green
Technical Data	
Operating voltage	max. 60 V DC
Operating voltage (only UL listed)	max. 30 V DC
Rated surge voltage	1.5 kV
Operating current per contact	max. 4 A
Material group	IEC 60664-1, category I
Transfer parameters	CAT5, Class D (ISO/IEC 11801:2002), (EN 50173-1)
Transfer rate	up to 100 Mbit/s full duplex
Coding	M12, D-coded
Locking of ports	Screw thread (M12×1 mm) recommended torque 0.6 Nm, self-securing
Compression gland	M12 (SW13)
Protection	IP65, IP66K, IP67 inserted and tightened (EN 60529)
Locking material	Zinc die casting, matte nickel plated
Material	PUR
suitable for corrugated tube (internal Ø)	without
General data	

Standards	DIN EN 61076-2-101 (M12)
Pollution Degree	3
Temperature range	-25...+85 °C, depending on cable quality

Commercial data

country of origin	DE
customs tariff number	85444290
EAN	4048879379762
eClass	27061801
Packaging unit	1

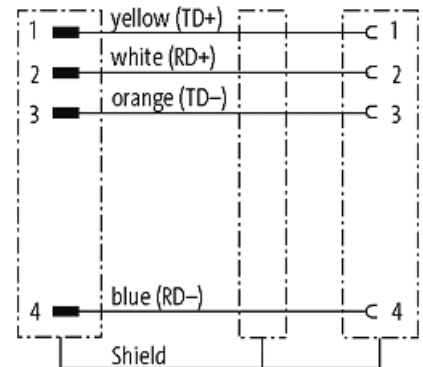
Sketch

Product may differ from Image