

M12 male 0° / M12 female 90° shielded Y-cod.

PUR AWG20/26 shielded gn UL/CSA/rob/drag ch 2,5m

Male straight – female 90°

M12, Y-coded

8-pole, shielded

Ethernet CAT5

Further cable lengths on request.

Plastic housings with good resistance against chemicals and oils.

The resistance to aggressive media should be individually tested for your application. Further details on request.

[Link to Product](#)

Illustration

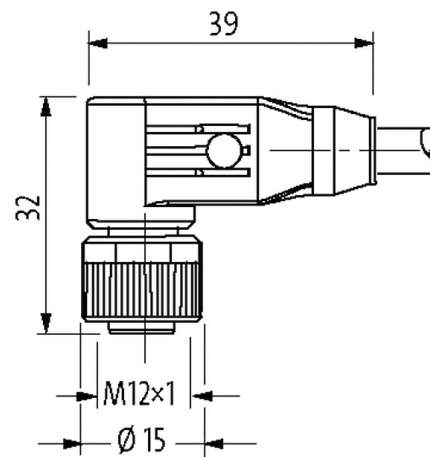
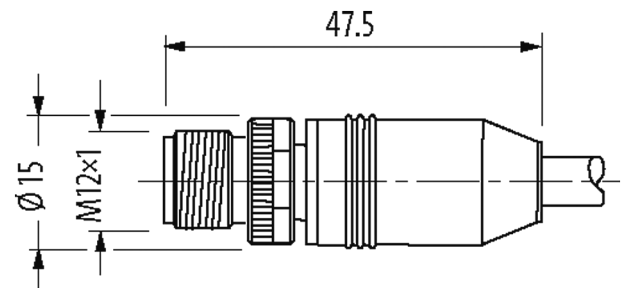
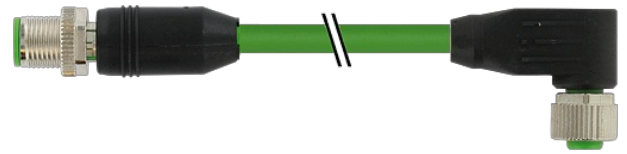

1	■	white/orange	C 1
2	■	orange	C 2
3	■	white/green	C 3
4	■	green	C 4
5	■	blue	C 5
6	■	white	C 6
7	■	brown	C 7
8	■	black	C 8
		shield	

Product may differ from Image

Approvals



* only for products with UL/CSA approved cable

More Info

EtherNet/IP

 EtherCAT

Form	
Form	47061
General data	
Pollution Degree	3
Temperature range	-25...+85 °C, depending on cable quality
Cables	
Cable number	831
No./diameter of wires	4 × 0.5 + 1 × 4 × 0.14 mm ²
Wire isolation	PUR (bl, wh, br, bk, (whor, or)) + (whgn, gn)
C-track properties	5 Mio.
Jacket Color	green
Material (jacket)	PUR (UL/CSA)
Outer Ø	8.1 mm ±5%
Bend radius (moving)	10 × outer Ø
Temperature range (fixed)	-50...+80 °C
Temperature range (mobile)	-40...+80 °C
Cable identification	831
Approval (cable)	UL (AWM-Style 20233/10493), CSA; CE conform
Cable weight [g/m]	107,8
Diameter (core)	4 × 0.5 + 1 × 4 × 0.14 mm ²
Material (wire isolation)	PP
Material property (wire isolation)	CFC-, halogen-, cadmium-, silicone- and lead-free
Shore hardness (wire isolation)	55 ±5 D
Color/numbering of wires	(bk, br, wh, bl), (whor, or, whgn, gn)
Shield	yes
	min. 85%
Material (jacket)	PUR
Material property (jacket)	CFC-, halogen-, cadmium-, silicone- and lead-free, matt, low-adhesion, machine easy to process, abrasion-resistant, hydrolysis and microbial resistant
Shore hardness (jacket)	90 ±5 A
Outer-Ø (jacket)	8.1 mm ±5%
Color (jacket)	green
chemical resistance	good resistance to oil, gasoline and chemicals (VDE 0472 Teil 803 Test B)
thermal resistance	flame retardant UL 1581 VW1 / CSA FT1 / IEC 60332-1, IEC 60332-2-2
Nominal voltage	60 V AC
Test voltage	1000 V AC
Current load capacity	to DIN VDE 0298-4
Temperature range (fixed)	-50...+80 °C
Temperature range (mobile)	-40...+80 °C, (+90 °C at max. 10 000 operating hours)
Bend radius (fixed)	5 × outer Ø
Bend radius (moving)	10 × outer Ø
No. of bending cycles (C-track)	max. 5 Mio. (25 °C)
Traversing distance (C-track)	max. 5 m (horizontal)
Travel speed (C-track)	max. 3.3 m/s

Acceleration (C-track)	max. 5 m/s ²
Torsion stress	±30 °/m
No. of torsion cycles	max. 2 Mio. (25 °C)
Torsion speed	35 cycles/min

Technical Data

Operating voltage	max. 50 V AC/DC
Operating voltage (only UL listed)	30 V DC
Rated surge voltage	0.8 kV
Operating current per contact	0.5 A (Data), 6 A (Power)
Material group	IEC 60664-1, category I
Transfer parameters	CAT5, Class D (ISO/IEC 11801:2002), (EN 50173-1)
Transfer rate	up to 100 Mbit/s full duplex
Coding	Y-coded
Locking of ports	Screw thread (M12×1 mm) recommended torque 0.6 Nm, self-securing
Compression gland	M12 (SW13)
Protection	IP67 inserted and tightened (EN 60529)
Locking material	Zinc die casting, matte nickel plated
Material	PUR

Commercial data

country of origin	DE
customs tariff number	85444290
EAN	4048879716260
eClass	27061801
Packaging unit	1

Sketch

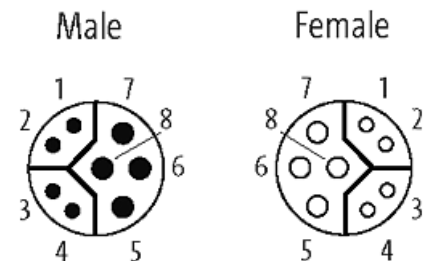

Product may differ from Image