

M12 male 0° / M12 female 0°

PUR 12x0.25 gy UL/CSA+drag chain 20m

Male straight – female straight

M12 – M12, 12-pole

Art-No. 7005 - M12 Lite - (plastic hexagonal screw) on request

Plastic housings with good resistance against chemicals and oils.

The resistance to aggressive media should be individually tested for your application. Further details on request.

Further cable lengths on request.

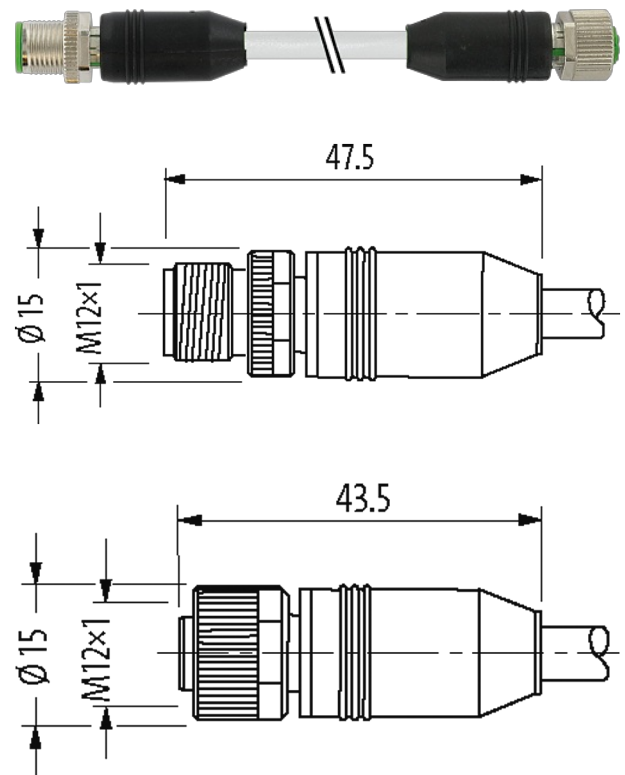
Link to Product**Illustration**

Product may differ from Image

Approvals

cCSAus

* only for products with UL/CSA approved cable

Form

Form 53001

General data

Standards	DIN EN 61076-2-101 (M12)
Temperature range	-25...+85 °C, depending on cable quality

Cables

No./diameter of wires	12× 0.25 mm ²
Wire isolation	PP (br, bl, wh, gn, pk, ye, bk, gr, rd, vi, grp, rdbl)
C-track properties	3 Mio.

Material (jacket)	PUR (UL/CSA)
Outer Ø	6.9 mm ±5%
Bend radius (moving)	15× outer Ø
Temperature range (fixed)	-40...+80 °C
Temperature range (mobile)	-20...+80 °C
Cable identification	301
Approval (cable)	UL (AWM-Style 20233/10978), CSA approbation; CE
Cable weight [g/m]	69,30
Material (wire)	Cu wire, bare
Resistor (core)	max. 76 Ω/km (20 °C)
Single wire Ø (core)	0.1 mm
Construction (core)	32× 0.1 mm (multi-strand wire class 6)
Diameter (core)	12× 0.25 mm ²
AWG	similar to AWG 24
Material (wire isolation)	PP
Material property (wire isolation)	CFC-, halogen-, cadmium-, silicone- and lead-free
Shore hardness (wire isolation)	50 ±5 D
Wire-Ø incl. isolation	1.25 mm ±5%
Color/numbering of wires	br, rd, gr, bk, ye, pk, gn, wh, bl, rdbl, grpk, vi
Stranding combination	Twisted wires rdbl, grpk and vi, over it all other wires are twisted
Shield	no
Material (jacket)	PUR
Shore hardness (jacket)	85 ±5 A
Outer-Ø (jacket)	6.9 mm ±5%
Color (jacket)	gray
chemical resistance	good resistance to oil, gasoline and chemicals (VDE 0472 Teil 803 Test B)
Nominal voltage	300 V
Test voltage	1500 V
Current load capacity	to DIN VDE 0298-4
Temperature range (fixed)	-40...+80 °C
Temperature range (mobile)	-20...+80 °C
Bend radius (fixed)	10× outer Ø
Bend radius (moving)	15× outer Ø
No. of bending cycles (C-track)	max. 3 Mio. (25 °C)
Traversing distance (C-track)	max. 5 m (horizontal)
Travel speed (C-track)	max. 2 m/s
Acceleration (C-track)	max. 10 m/s ²
Jacket Color	gray
Technical Data	
Operating voltage	max. 30 V AC/DC
Rated surge voltage	0.8 kV
Operating current per contact	max. 1.5 A
Locking of ports	Screw thread (M12×1 mm) recommended torque 0.6 Nm, self-securing
Compression gland	M12 (SW13)
Protection	IP65, IP66K, IP67 inserted and tightened (EN 60529)
Locking material	Zinc die casting, matte nickel plated
Commercial data	
country of origin	DE

customs tariff number	85444290
EAN	4048879826341
eClass	27279218
Packaging unit	1

Sketch

1	■	brown	⌋	1
2	■	blue	⌋	2
3	■	white	⌋	3
4	■	green	⌋	4
5	■	pink	⌋	5
6	■	yellow	⌋	6
7	■	black	⌋	7
8	■	gray	⌋	8
9	■	red	⌋	9
10	■	violet	⌋	10
11	■	gray/pink	⌋	11
12	■	red/blue	⌋	12

Male

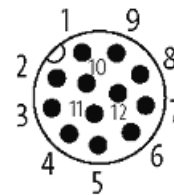

Female

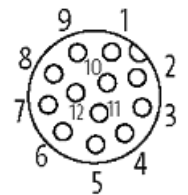

Product may differ from Image