

M12 MALE 0° / M12 FEMALE 90°

PUR 12x0,14 black UL/CSA, drag ch 10m

Male straight – female 90°

M12 – M12, 12-pole

Art-No. 7005 - M12 Lite - (plastic hexagonal screw) on request

Plastic housings with good resistance against chemicals and oils.

The resistance to aggressive media should be individually tested for your application. Further details on request.

Further cable lengths on request.

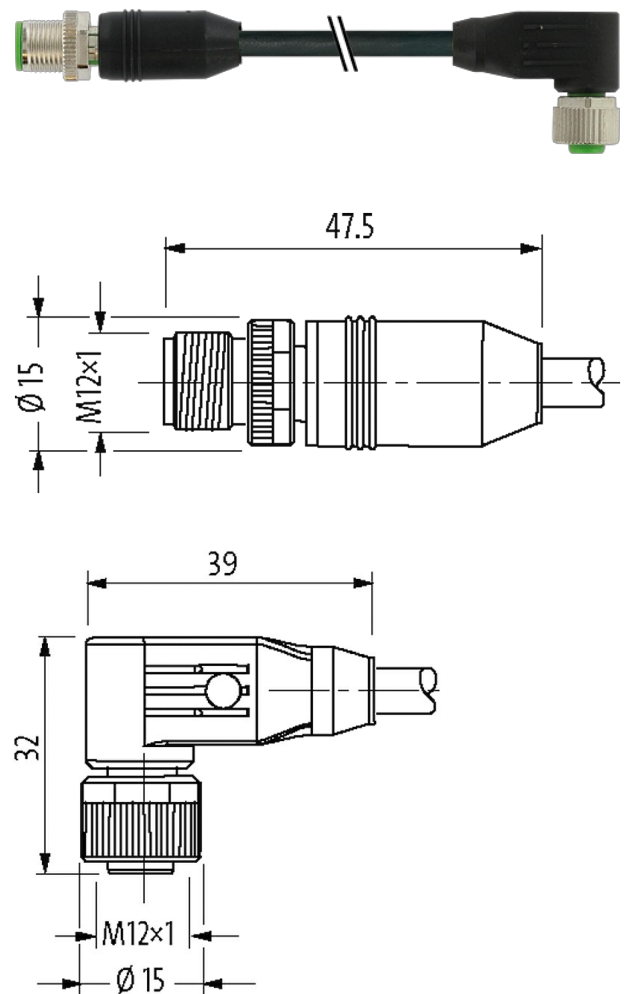
[Link to Product](#)**Illustration**

Product may differ from Image

Approvals**Form**

Form

53021

General data	
Standards	DIN EN 61076-2-101 (M12)
Pollution Degree	3
Temperature range	-25...+85 °C, depending on cable quality
Cables	
No./diameter of wires	12× 0.14 mm ²
Wire isolation	PP (br, bl, wh, gn, pk, ye, bk, gr, rd, vi, grpk, rdbl)
C-track properties	2 Mio.
Material (jacket)	PUR (UL/CSA)
Outer Ø	6.0 mm ±5%
Bend radius (moving)	10× outer Ø
Temperature range (fixed)	-40...+85 °C
Temperature range (mobile)	-25...+85 °C
Cable identification	705
Approval (cable)	UL (AWM-Style 20233/10493), CSA; CE conform
Cable weight [g/m]	45,10
Material (wire)	Cu wire, bare
Resistor (core)	max. 138 Ω/km (20 °C)
Single wire Ø (core)	0.1 mm
Construction (core)	18× 0.1 mm (multi-strand wire class 6)
Diameter (core)	12× 0.14 mm ²
AWG	similar to AWG 26
Material (wire isolation)	PP
Material property (wire isolation)	CFC-, halogen-, cadmium-, silicone- and lead-free
Wire-Ø incl. isolation	1.0 mm ±5%
Color/numbering of wires	br, rd, gr, bk, ye, pk, gn, wh, bl, rdbl, grpk, vi
Shield	no
Material (jacket)	PUR
Shore hardness (jacket)	92 ±5 A
Outer-Ø (jacket)	6.0 mm ±5%
Color (jacket)	black
chemical resistance	good resistance to oil, gasoline and chemicals (VDE 0472 Teil 803 Test B)
Nominal voltage	300 V AC
Test voltage	1500 V AC
Temperature range (fixed)	-40...+85 °C
Temperature range (mobile)	-25...+85 °C
Bend radius (fixed)	7.5× outer Ø
Bend radius (moving)	10× outer Ø
No. of bending cycles (C-track)	max. 2 Mio. (25 °C)
Traversing distance (C-track)	max. 5 m (horizontal)
Travel speed (C-track)	max. 3.3 m/s
Acceleration (C-track)	max. 5 m/s ²
Torsion stress	±180°/m
Jacket Color	black
Technical Data	
Operating voltage	max. 30 V AC/DC
Operating current per contact	max. 1.5 A
Material group	IEC 60664-1, category I
Locking of ports	Screw thread (M12×1 mm) recommended torque 0.6 Nm, self-securing

Compression gland	M12 (SW13)
Protection	IP66K, IP67 inserted and tightened (EN 60529)
Locking material	Zinc die casting, matte nickel plated
Material	PUR
Rated surge voltage	0.8 kV

Commercial data

country of origin	DE
customs tariff number	85444290
EAN	4048879523011
eClass	27279218
Packaging unit	1

Sketch

1	■ brown	⊂ 1
2	■ blue	⊂ 2
3	■ white	⊂ 3
4	■ green	⊂ 4
5	■ pink	⊂ 5
6	■ yellow	⊂ 6
7	■ black	⊂ 7
8	■ gray	⊂ 8
9	■ red	⊂ 9
10	■ violet	⊂ 10
11	■ gray/pink	⊂ 11
12	■ red/blue	⊂ 12

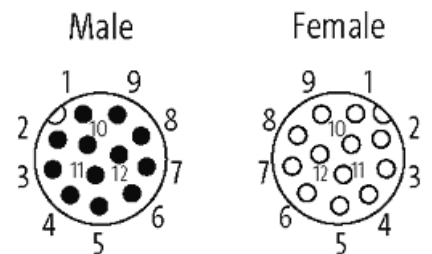

Product may differ from Image