

MQ15-X-Power female 90° right, with cable

PVC 4x1,5 bk UL/CSA 25,0m

Female 90°

MQ15, 4-pole

without cable sleeves

Plastic housings with good resistance against chemicals and oils.

The resistance to aggressive media should be individually tested for your application. Further details on request.

Further cable lengths on request.

[Link to Product](#)

Illustration

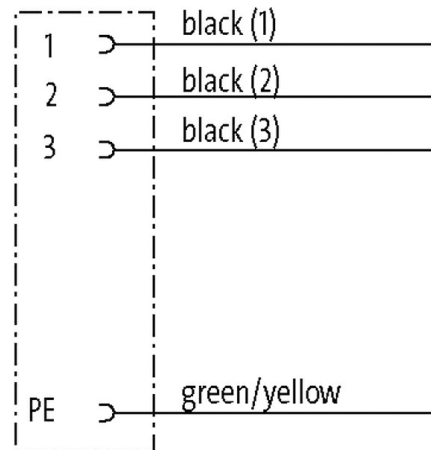
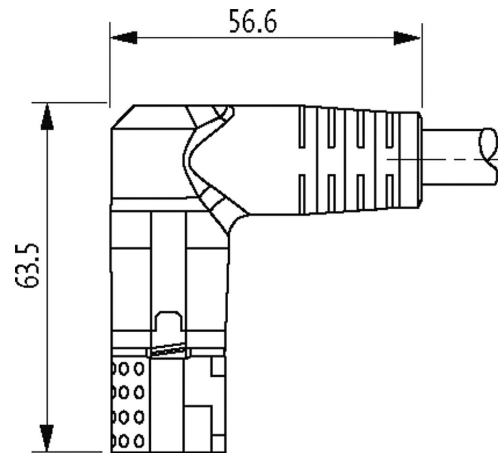
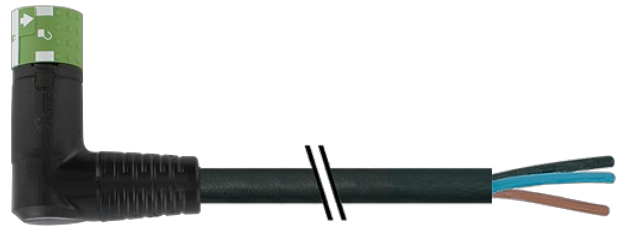

Female

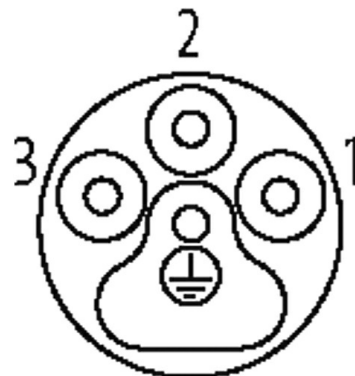

Product may differ from Image

Form

Form	P8231
General data	
Mounting method	inserted, tightened
Material (contact carrier)	PA
Material (contact)	Copper alloy
Material (contact surface)	Ag
Pollution Degree	3
Stripping length (jacket)	30 mm
Temperature range	-25...+80 °C, depending on cable quality
Cables	
Cable number	P22
No./diameter of wires	4 × 1.5 mm ²
Wire isolation	PP (bk num, gnye)
Jacket Color	black
Material (jacket)	PVC (UL)
Outer Ø	7.4 mm ±5%
Bend radius (moving)	15 × outer Ø
Temperature range (mobile)	-5...+80 °C
Temperature range (fixed)	-20...+80 °C
Cable identification	P22
Material (wire)	Cu wire, bare
Resistor (core)	max. 13.3 Ω/km (20 °C)
AWG	similar to AWG 16
Color/numbering of wires	bk numbered, gnye longitudinally striped
Shield	no
Material (jacket)	PVC
Outer-Ø (jacket)	7.4 mm ±5%
Color (jacket)	black
thermal resistance	flame retardant
Nominal voltage	1000 V AC
Test voltage	4000 V
Temperature range (fixed)	-20...+80 °C
Bend radius (fixed)	5 × outer Ø
Technical Data	
Operating voltage	max. 600 V AC
Rated surge voltage	4.0 kV
Operating current per contact	max. 13 A
Material group	IEC 60664-1, category I
No. of poles	4
Configuration	fully used
LED display	no
Locking of ports	Quick connection, 1/4 turn
Protection	IP67 inserted and tightened (EN 60529)
Material	Flame retardant plastic acc. to (UL 94)
Mating cycles	≥ 500
Commercial data	
country of origin	DE

customs tariff number	85444290
EAN	4048879707725
eClass	27279218
Packaging unit	1