

Mini (7/8) 5 pole, Male (Ext.) 90°/Female 90° ,

PUR, UL/CSA, 5x16AWG, black, 10m

Male 90° – female 90°

7/8" – 7/8", 5-pole

Power cable

USA

Further cable lengths on request.

Plastic housings with good resistance against chemicals and oils.

The resistance to aggressive media should be individually tested for your application. Further details on request.

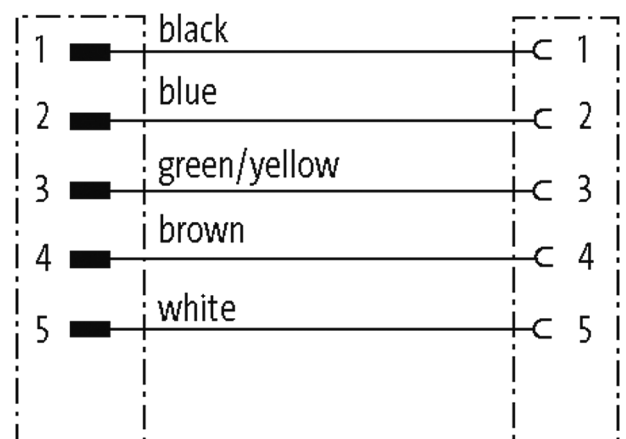
[Link to Product](#)**Illustration**

Product may differ from Image

Approvals

* only for products with UL/CSA approved cable

Form

Form A5A31

General data

Temperature range -25...+80 °C, depending on cable quality

Cables

Cable number	UMD
No./diameter of wires	5 × 1.5 mm ²
Construction (core)	2.3 mm ±5%
Wire isolation	TPM (br, wh, bl, bk, gnye)

C-track properties	5 Mio.
Jacket Color	black
Material (jacket)	PUR (UL/CSA)
Outer Ø	8.7 mm ±5%
Bend radius (fixed)	7.5× outer Ø
Bend radius (moving)	10× outer Ø
Temperature range (fixed)	-50...+80 °C
Temperature range (mobile)	-20...+80 °C

Technical Data

Operating voltage	max. 600 V AC/DC
Operating current per contact	max. 9 A
Locking of ports	Screw thread 7/8" (recommended torque 1.5 Nm) self-securing
Compression gland	7/8" (SW24)
Protection	IP68 inserted and tightened (EN 60529)
Locking material	Zinc die casting, matte nickel plated
Material	PUR

Commercial data

country of origin	DE
customs tariff number	85444290
EAN	4048879635769
eClass	27279218
Packaging unit	1

Sketch

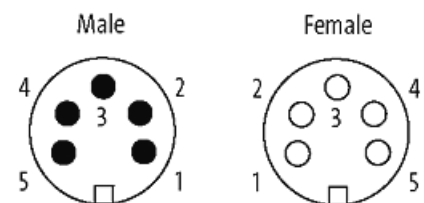
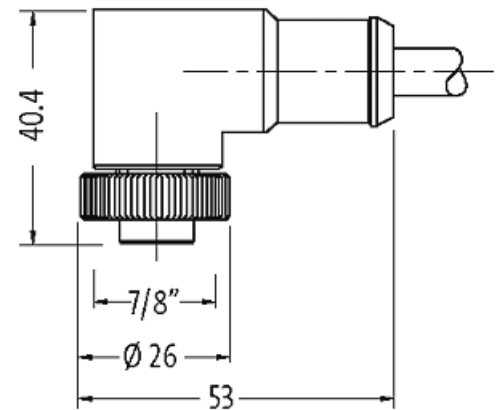

Product may differ from Image