

TRAFFIC LIGHT

Quadro LED-TL



Bright LED signal lights for traffic light applications, e.g. for

- traffic routing in non-public areas
- conveyor and storage systems
- crane safety (see also 'Regulations and standards for crane applications')
- container handling systems

- Extraordinary housing protection (IP 66, IK08 and UV-protected PC housing) and innovative LED technology provide for very bright signals, long service lives and reliable operation.
- Mounted using external lugs or internal holes that do not impair the IP protection; mounting can be performed in any direction.
- Preassembled as traffic light and ready to connect.
- Adjustable steady light or flashing light function provides indication of special operating conditions, e.g. on cranes or machines
- Also available as non-preassembled version (Quadro-LED-HI).



protection system



impact-proof housing



operating temperature



brightness adjustable



warranty



PRODUCT	Quadro LED-TL	
---------	---------------	--

DATA		
Rated voltage	115/230 V	24 V
	AC 50 60 Hz / DC	DC
Operating range	90–253 V	11–60 V
Current consumption (@ 1 Hz flash, ●●●●) ¹	45 / 55 / 55 mA @ 230 V AC	165 / 165 / 165 mA @ 24 V DC
Operating mode	continuous light blinking light 1 / 2 Hz flashing light 0.1 / 0.5 / 0.75 / 1 / 2 Hz	
Control of operating mode	internally	internally / externally
Light source	4 high output LED per single unit	
Light intensity (DIN 5037) ²	75 cd (reducible) per single unit	
Max. viewing distance	201 m	
Operating temperature	–40 °C ... +55 °C	
Storage temperature	–40 °C ... +70 °C	
Relative humidity	100 %	
Protection system (EN 60529)	IP 66	
Service life of the light source	≥50,000 hrs	
Material	lens	●●● polycarbonate (PC)
	housing	polycarbonate (PC), grey RAL 7035
Cable entry	M20/M32 sideways, other imprints prepared	
Connecting terminal	cage clamp 0.08–2.5 mm ² (in the red light)	
Mounting	external lugs or internal holes	
Weight	3x 500 g	

¹Other colors and operating modes, see manual
² with a clear lens

DIMENSIONS

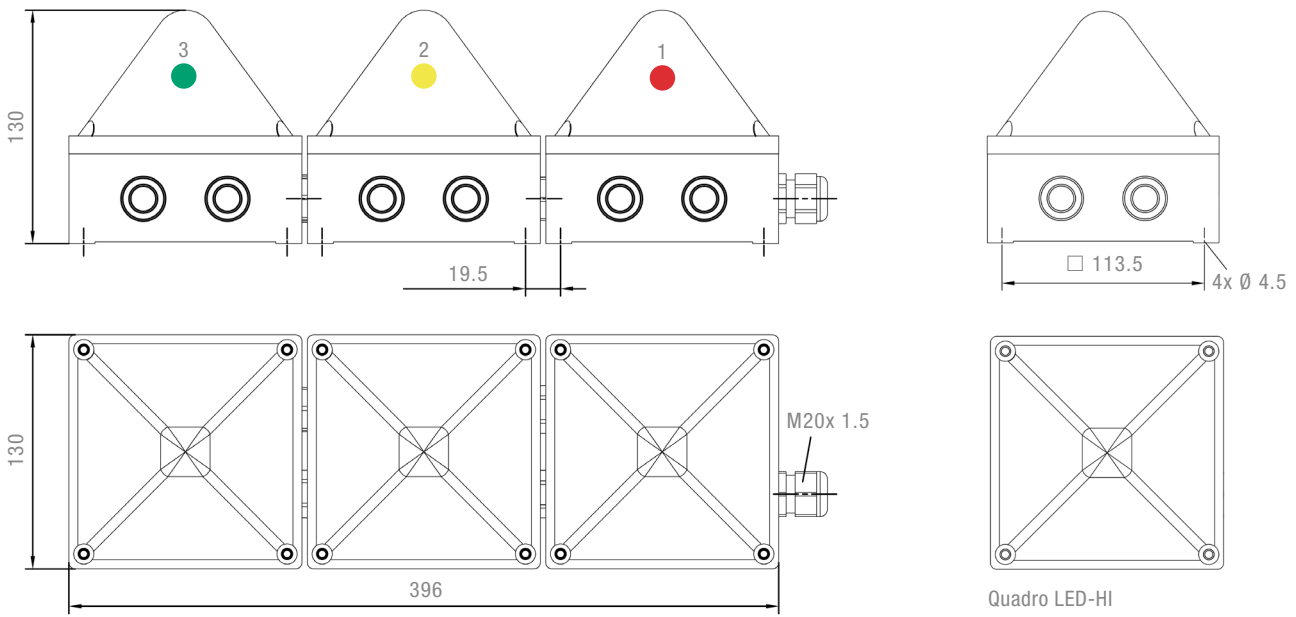

CONNECTION DIAGRAMS

Quadro-LED TL

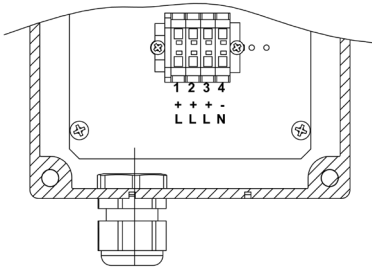

Single unit – 230 V

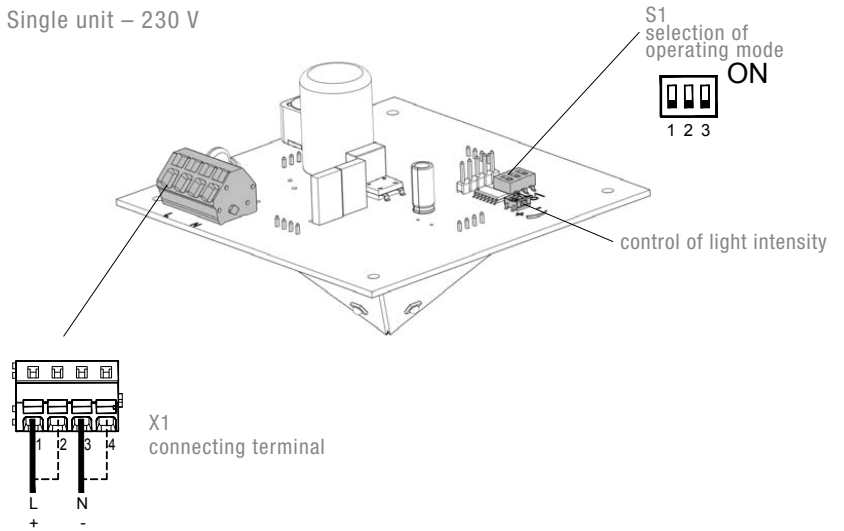

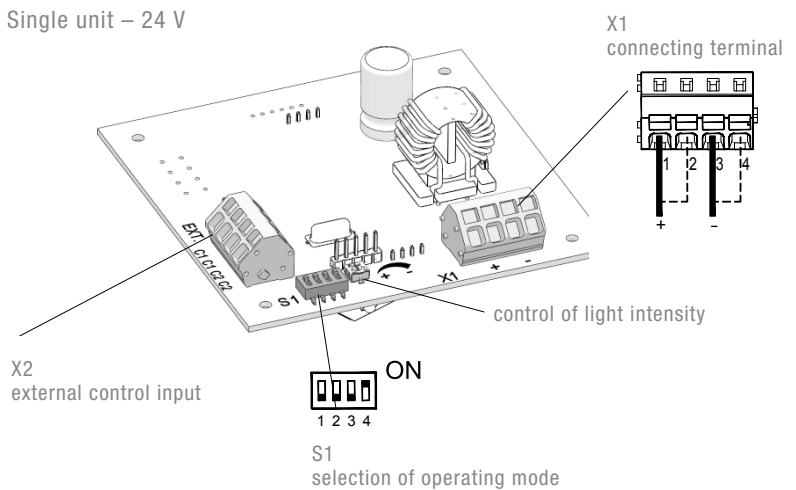

Single unit – 24 V



ARTICLE NO.	Quadro LED-TL	
LENS COLOUR	115/230 V AC	24 V DC
	21106640008	21106630008

Article numbers for other combinations on request.

For single units please use the Quadro LED-HI

ARTICLE NO.	Quadro-LED-HI	
LENS COLOUR	230 V AC	24 V DC
	21108643000	21108633000
	21108644000	21108634000
	21108645000	21108635000

Article numbers for other colours on request.

OPTIONS/ACCESSORIES



Article no.
28112000003

Regulations and standards for crane applications

DIN-EN 13000:2004-09 Cranes – truck-mounted cranes	Visual warning to the driver (EN 842) in the case of	<ul style="list-style-type: none"> approaching the load capacity (at 90–98.5 % of the permissible load capacity) triggering of the overload safety system overriding of the overload safety system
DIN-EN 14439:2006 Safety – rotating tower cranes	Visual warning by the crane driver (EN 457) to persons in the vicinity in the case of	<ul style="list-style-type: none"> remote control – green, continuous light anti-collision – white, blinking light rotating (in some cases when required by local authorities) – green, blinking light
	Visual warning to the driver (EN 842) in the case of	<ul style="list-style-type: none"> approaching the load capacity (at 90–95 % of the permissible load capacity) – yellow, continuous light wind warning and alarm – yellow, blinking light and red, blinking light

CONFORMITY TO STANDARDS

The visual characteristics of LED lights conform to the European standard DIN EN 842; “**Machine safety – visual alarm signals**”. Requirements contained in the DIN EN 981 standard; “**Machine safety – system of acoustic and visual alarm and information signals**”, can be fulfilled. The colours “red” for the emergency signal and “yellow” for the warning signal conform to the requirements of IEC 73 / DIN EN 60073 / VDE 0199; “**Coding of display devices and control elements using colours and supplementary means**”.

References to visual alarm devices can be found in the following standards:
 EN 60825-1 Radiation safety of laser devices, identical to IEC 825 and DIN-VDE 0837
 DIN EN 54 Fire alarm systems
 DIN 54113-2 Radiation protection regulations for the technical operation of X-ray equipment up to 500 kV